

Market Code Schedule 20

Code Subsidiary Document CSD 0301

Data Transaction Catalogue Annex A

Version: 13.0

Date: 2016-05-05

Document Ref: CSD0301 Annex A

Change History

Version Number	Date of Issue	Reason For Change	Change Control Reference	Sections Affected
1.1	10/08/2007	Created from CMA Interface Specification v1.0		
1.2	17/10/2007	Updated for XML schema v3.9		Appendix B
1.3	17/08/2009	Re-assessed Charges	MCCP035-CC	Appendix B
1.4	28/06/2010	Customer Names on Database	MCCP041-CC	Appendix B
1.5	27/09/2010	September 2010 Release		Appendix A, Appendix B
1.6	23/03/2011	March 2011 Release		Appendix B
1.7	15/11/2011	September 2011 Release v3.1		Appendix B
1.8	30/03/2012	March 2012 Release v3.2		Appendix B
2.0	21/06/2012	June 2012 Release v3.3		Appendix B
3.0	28/09/2012	September 2012 Release v3.4		Appendix B
4.0	20/03/2013	March 2013 Release v3.5		Appendix B
5.0	21/08/2013	September 2013 Release v3.6		Appendix B
6.0	04/03/2014	March 2014 Release v3.7		Appendix B
7.0	15/09/2014	September 2014 Release v4.1		Appendix B
8.0	31/03/2015	March 2015 Release v4.2		Section 3 Appendix B
9.0	03/06/2015	No Changes. Alignment with CSD0301	MCCP177	Change History

10.0	24/06/2015	No changes, Alignment with CSD0301	MCCP179	Change History
11.0	04/09/2015	September 2015 Release v4.3		Appendix B
12.0	16/12/2015	March 2016 Release v4.4		Appendix B
13.0	05/05/2016	May 2016 Release v4.4.1		Appendix B

Table of Contents

1.	Introduction	5
2.	Overview	6
3.	Transport and Message Level Security	6
3.1	Process	6
3.2	The client initialises and sends a message with X.509 certificate information.	7
3.3	The service authenticates the client using the X.509 certificate and signature.	8
4.	Message Submission and Retrieval	11
4.1	High level view of message exchange	13
4.2	CMA Messages in detail	16
4.3	Submission of document	17
4.4	Requesting New Messages	18
4.5	Handling Optional Data	20
	Appendix A – Web Services Definition Language (WSDL)	22
	Appendix B – XML Schema Documentation	24

1. Introduction

The Central Systems provides two types of interface via which Trading Parties (wholesaler and licensed providers) may communicate with the CMA. The Low Volume Interface (LVI) consists of a web based user interface via which market participants may submit messages and receive notifications from the CMA. The High Volume Interface (HVI) is intended to allow market participants with high transaction volumes to make the submissions to the CMA and fetch responses and notifications systematically. This document describes only the High Volume Interface.

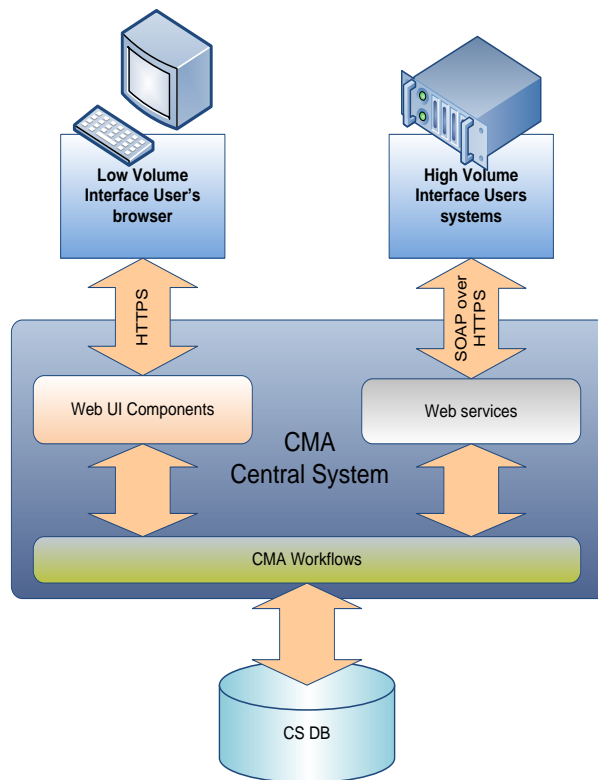

LVI (Web UI Components) and HVI (Web services)

2. Overview

The CMA HVI web service has been implemented using Message Layer Security with X.509 certificates and WSE 3.0. The objectives of this are:

- To secure message exchange between two parties using brokered authentication with X509.Certificates
- To combine an implementation of mutual authentication message exchange between client and server
- To ensure data origin authentication and data confidentiality.

Full details of best practice can be found at:

<http://msdn.microsoft.com/en-us/library/aa480565.aspx>

<http://msdn.microsoft.com/en-us/library/aa480581.aspx>

3. Transport and Message Level Security

The transport mechanism is based on TLS over HTTP. The client application must request an TLS session from the CMA server. The client must send a signed SOAP document to the CMA and wait for a synchronous response. The sending party should receive a response message or a system timeout. If a timeout occurs the sending party should retry sending the same message (with the same MID).

Each message sent to the CMA Central Systems must be a digitally signed, well formed and a valid XML document conforming to the CMADData Schema Document (see Appendix B for schema documentation). The XML document should be wrapped in a SOAP 1.2 envelope and be transported to the CMA using HTTPS. The sending party must establish a secure connection over the public Internet using the Transport Layer Security (TLS) protocol version 1.0+. Multiple messages can be sent in one document, but they must be of the same type. The CMA may return a single document with multiple messages of different types.

3.1 Process

Using message layer security with X.509 certificates in WSE 3.0 involves the following participants:

Client. The client accesses the Web service, and provides credentials for authentication during the request to the Web service.

Service. The service is the Web service that requires authentication of the client to make access control decisions. In our case the HVI.

The steps provided are based on the behaviour of the mutualCertificate10Security assertion. The steps are divided into the following two sections based on what happens on the client and then on the service:

- The client initializes and sends a message with X.509 certificate information.
- The service authenticates the client using the X.509 certificate and signature.

3.2 The client initialises and sends a message with X.509 certificate information.

This part of the process has six steps:

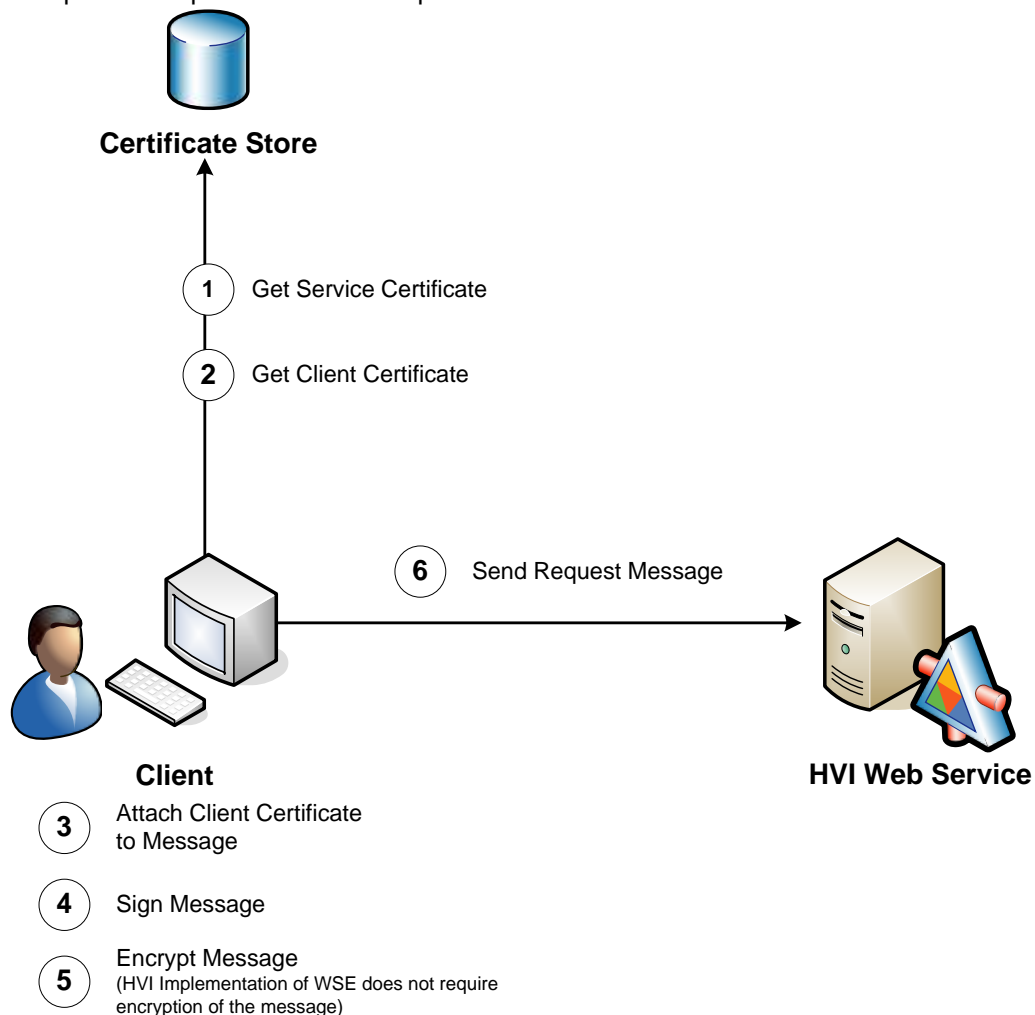

1. The client retrieves the service's X.509 certificate.
2. The client retrieves its own certificate and private key.

3. The client attaches its X.509 certificate to a message.
4. The client signs the message using its private key.
5. The client encrypts the message using the service's public key. **(In the HVI Implementation of this is not required)**
6. The client sends the message to the service.

3.3 The service authenticates the client using the X.509 certificate and signature.

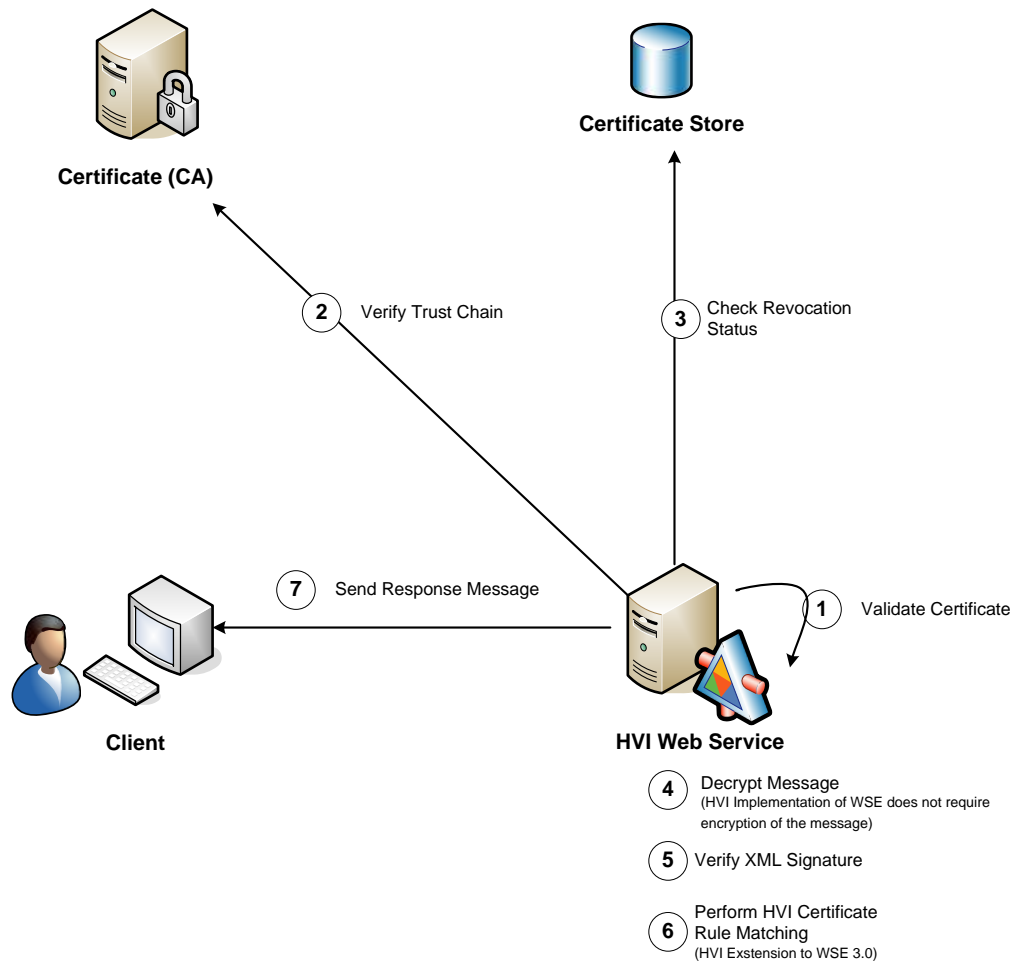

1. The service validates the client's certificate.
2. The service verifies the certificate trust chain. Authority (CA)
3. The service checks the certificate revocation status.
4. The service decrypts the message. (HVI Implementation does not require encryption so this is not performed)
5. The service verifies the signature.

6. The service performs HVI Certificate Rule Matching
7. The service initializes and sends a response to the client.

Step One: The Service Validates the Client's Certificate

WSE 3.0 validates the client's certificate attached to the request message. The certificate's validity period is checked to ensure that the service does not process a request that was secured with an expired X.509 certificate.

WSE 3.0 also verifies the integrity of the certificate's contents to ensure that it has not been tampered with after the certificate authority (CA) issued it. The integrity of the certificate's contents is verified using the signature of the issuing CA, which is also included in the certificate. If the certificate's contents cannot be validated against the issuer's signature, then the certificate has been tampered with and it is rejected as invalid.

Step Two: The Service Verifies the Certificate Trust Chain

By default, WSE 3.0 verifies the trust chain of certificates, or requires that the client's certificate is installed in the Trusted People folder in the service's local certificate store. WSE 3.0 must be able to recognize an issuing CA as trusted to verify the certificate trust chain for the client's X.509 certificate. WSE 3.0 recognizes an issuing CA as trusted based on the X.509 certificate that endorses the client's certificate. WSE 3.0 recognizes the issuing CA's certificate as a trusted root for a certificate chain if the CA's X.509 certificate is installed in the machine certificate store in the Trusted Root Certification Authorities folder.

In the HVI Configuration the client's certificate must be installed in the Trusted People Folder.

Step Three: The Service Checks the Certificate Revocation Status

WSE 3.0 policy checks the revocation status of the certificate by verifying whether the certificate is on a certificate revocation list (CRL) that the CA publishes.

Step Four: The Service Decrypts the Message

By default, the mutualCertificate10Security assertion protects the message body by encrypting it. When WSE 3.0 receives an encrypted message, WSE 3.0 policy automatically decrypts it using the following steps:

1. WSE determines the value to identify the service's certificate either the RFC3280 Subject Key Identifier, or the issuer name and serial number that the client included in the message tells the service which certificate was used to encrypt the message. WSE 3.0 policy uses this value to determine which private key it must use to decrypt the message.
2. WSE decrypts the asymmetrically encrypted, one-time symmetric key that the client sent with the message, using the service's private key
3. WSE uses the symmetric key to decrypt the message data using a symmetric algorithm. By default, WSE 3.0 uses AES 256 for symmetric encryption.

Note: service side policy alone does not stop a client from sending an unencrypted message. However, the policy will reject a message at the server if it is not encrypted.

The HVI does not require encrypted messages and does not encrypt message bodies.

Step Five: The Service Verifies the Signature

WSE 3.0 verifies the client's signature on the incoming request message using the public key sent with the message. If the message data is signed, this step also validates the client as the message originator to provide data origin authentication.

Step Six: The Service Performs HVI Certificate Matching

The out of the box WSE3.0 functionality has been extended to enable verification of XML received by the HVI service from participants.

The additional verification step will verify that the SenderOrgId specified within the XML message received matches the OrgId of the client certificate. This verification is known as Certificate Rule Matching.

- The Sender Org Id Is retrieved from the XML Message
- The Certificate Rules for the sender Org Id are retrieved from the HVI Service Web.config file
- The CerifcateRuleCheck class will compare the Clients Certificate retrieved in the request with the Certificate Rules from the web config
- If there are any matches found the client will be verified and the XML message will be processed. If not a Soap Exception will be raised with the message "Certificate Rule Failure. No valid matching certificate rules identified."

4. Message Submission and Retrieval

The Web Service conforms to the SOAP 1.2 protocol and is defined by the Web Services Definition Language (WSDL) file in Appendix A. The SOAP definition can be found at <http://www.w3.org/TR/soap/>. The XML messages exchanged via the CMA Web Service must be valid SOAP messages and the **soap:Body** must contain one Document element conforming to the schema.

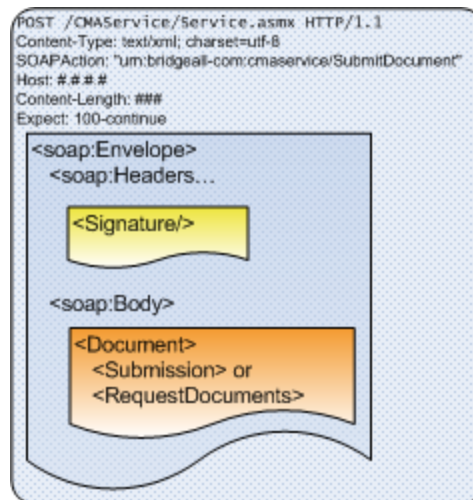
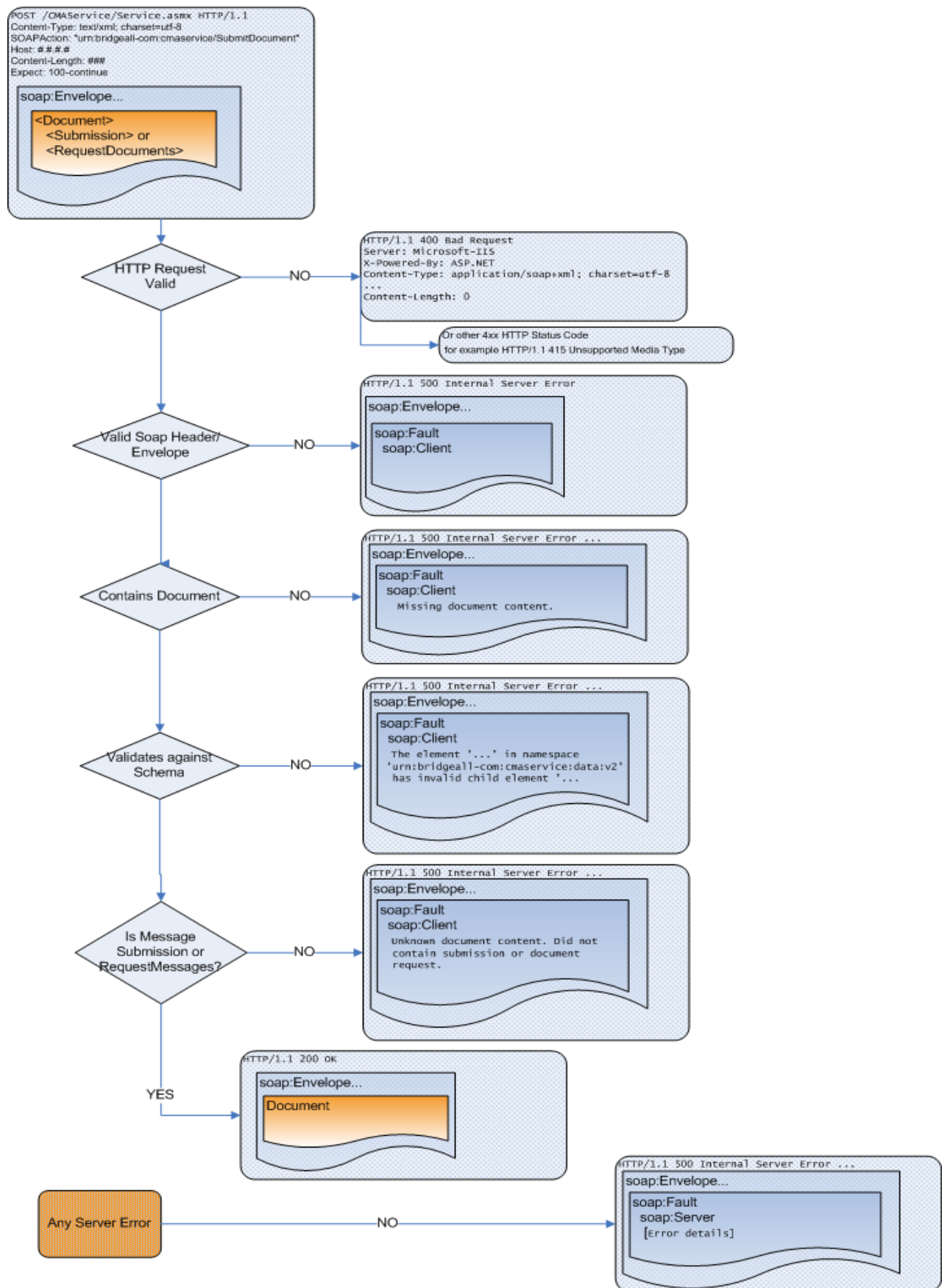

Figure 1 - Example participant submission over HTTP

The figure on the next page details the validation that the CMA Central Systems carry out on all document submissions over the XML interface. Firstly the request is checked to ensure it is a valid HTTP request. If not, a HTTP error is returned with a standard HTTP 4.xx error code indicating what the issue was. If the HTTP request is valid then the SOAP message tags are examined and verified. Only when a valid SOAP message has been received with a Document in the SOAP Body that contains either a Submission or a RequestMessages tag will the message be processed. See the diagram below for detail on the error handling.



4.1 High level view of message exchange

The Document element can have one of four valid children Submission, RequestMessages, Response or Handshakes.

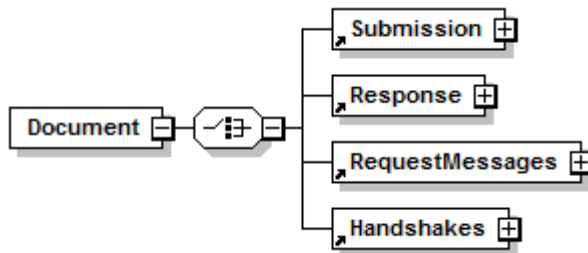

Figure 2 - Structure of all CMA XML Documents

All messages submitted to the CMA will receive an immediate synchronous response to confirm the message has been received.

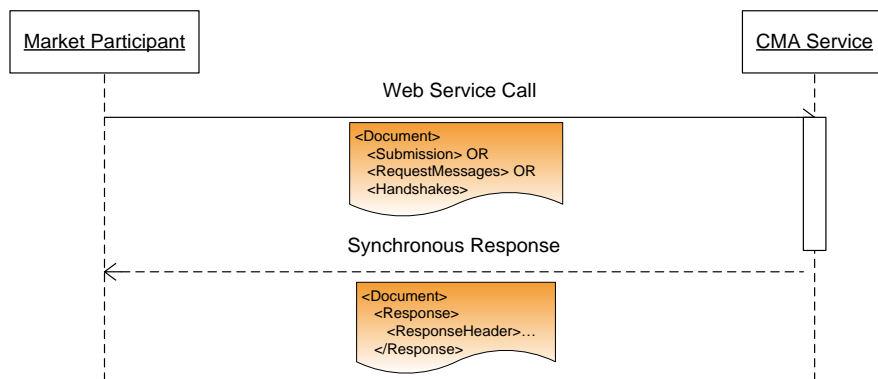
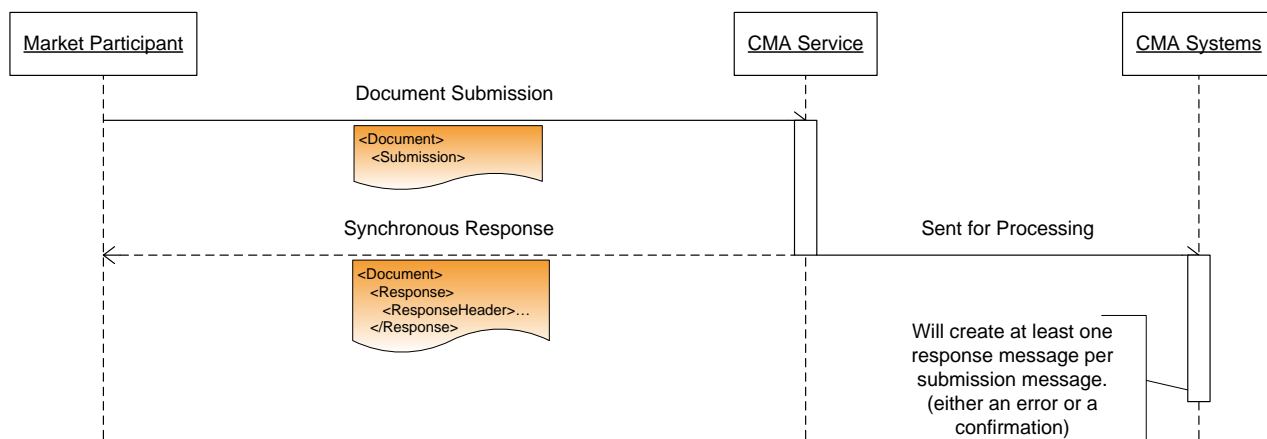

Figure 3 - Basic Submission with synchronous response

There will be a further asynchronous response at a later time when the CMA processes the message contents.



For example if a Licensed Participant called **ANLP** wished to submit a T012.1 to inform the CMA of an update to a service element they would generate their own unique message ID and populate the MID with this unique id and create a Submission element, wrap it in the SOAP 1.2 envelope (SOAP tags not shown below) and post it to the CMA web service.

<Submission

xmlns:xsi=<http://www.w3.org/2001/XMLSchema-instance>

xmlns:xsd="http://www.w3.org/2001/XMLSchema"

xmlns="urn:bridgeall-com:cmaservice:data:v3">

<Header>

<D1005_SenderOrgId>ANLP</D1005_SenderOrgId>

<D1006_RecipientOrgId>CMA</D1006_RecipientOrgId>

<D1007_TransactionTimestamp>2008-08-02T14:04:46</D1007_TransactionTimestamp>

<D1003_FlowReference />

</Header>

<Messages>

<T012.1_ServiceElementUpdates>

<T012.1_ServiceElementUpdate MID="ANLP00100000586">

<D2001_SPID>20000070103</D2001_SPID>

<D2018_TroughsDrinkingBowls>2</D2018_TroughsDrinkingBowls>

<D4006_EffectiveFrom>2008-05-02</D4006_EffectiveFrom>

<D4003_Comment>Added two troughs</D4003_Comment>

</T012.1_ServiceElementUpdate>

</T012.1_ServiceElementUpdates>

</Messages>

</Submission>

If the request is well formed and valid, the CMA will respond synchronously to this submission with a ResponseHeader as shown below. A unique flow reference is generated and issued by the CMA (D1003_FlowReference) which may be used in the future to identify the submission.

<Response

```

xmlns:xsi="http://www.w3.org/2001/XMLSchema-instance"
xmlns:xsd="http://www.w3.org/2001/XMLSchema"
xmlns="urn:bridgeall-com:cmaservice:data:v3">
<ResponseHeader>
  <D1005_SenderOrgId>CMA</D1005_SenderOrgId>
  <D1006_RecipientOrgId>ANLP</D1006_RecipientOrgId>
  <D1007_TransactionTimestamp>2008-08-02T14:04:47</D1007_TransactionTimestamp>
  <D1003_FlowReference>cd07ee64-de17-4d3f-a0b3-4bf6918ddf72</D1003_FlowReference>
  <
</ResponseHeader>
</Response>

```

This immediate synchronous response is acknowledgement that the CMA received the submission and that it was well formed and valid XML according to the schema. The Central Systems will then process the data in the request and within 24 hours an asynchronous message will be generated by the CMA in response to the submission. To receive these responses the participant must poll the Central Systems periodically to receive them. In order to do this a RequestMessages element must be sent specifying how many response messages the participant would like to receive. The example below requests just one response message at a time.

```

<cma:Document
  xsi:schemaLocation="urn:bridgeall-com:cmaservice:data:v3 CMADData_V3.xsd"
  xmlns:xsi="http://www.w3.org/2001/XMLSchema-instance"
  xmlns:cma="urn:bridgeall-com:cmaservice:data:v3">
  <cma:RequestMessages D1005_SenderOrgID="ANLP">
    <cma:NewMessages MaxMessages="1"/>
  </cma:RequestMessages>
</cma:Document>

```

The CMA will send back a T009.0 asynchronous response to the original message with either an OK if the message was processed successfully by the Central Systems or an error code if there were any issues processing the information. The related MID should be used by the participant to correlate this response with the original message sent by the participant.

```

<ResponseMessages
  xmlns:xsi="http://www.w3.org/2001/XMLSchema-instance"
  xmlns:xsd="http://www.w3.org/2001/XMLSchema"
  xmlns="urn:bridgeall-com:cmaservice:data:v3">
  <T009.0_Notification MID="CMA000000000347" RelatedMID="ANLP00100000586">
    <D1008_DataItemRef>D2001_SPID</D1008_DataItemRef>
    <D4004_ReturnCode>OK</D4004_ReturnCode>
  </T009.0_Notification>
</ResponseMessages>

```

It should be noted that the Related MID will only be populated by the CMA when it is generated in response to a message sent by that LP. Unsolicited messages created by the CMA to inform and LP of an event, such as the outgoing LP being informed of a registration being cancelled, will not have a Related MID populated. The error transaction from the LP to the CMA is the only instance where the LP would have to populate the Related MID.

In summary, response messages can be classified as either a SOAP level or application level response. All valid messages will receive a synchronous SOAP level response. If the HTTP Request is valid and the SOAP envelope is valid and the message contains a valid document which contains a <Submission> element, then a synchronous response will be received containing a <ResponseHeader> element. There will be a further application level asynchronous response within one business day as the message is processed by the Central Systems. This is the response that has to be pulled from the CMA by sending a <RequestMessages> element to the CMA. If there are messages waiting for the participant then <ResponseMessages> will be returned and may contain the MID from any original message as the Related MID.

In order for the LP to confirm the message batch has been successfully received, a HandShake document type should be sent to the CMA service containing the D1003_FlowReference GUID value as detailed in the following example:

```
<?xml version="1.0" encoding="utf-8"?>
<Document xmlns:xsi="http://www.w3.org/2001/XMLSchema-instance"
xmlns:xsd="http://www.w3.org/2001/XMLSchema" xmlns="urn:bridgeall-
com:cmaservice:data:v3">
  <HandShakes D1005_SenderOrgID="SWBS">
    <HandShake D1003_FlowReference="b2a78b32-d273-4db5-a222-ecd14857c104" />
    <HandShake D1003_FlowReference="9272daf3-f3b9-4811-9b6f-110c2ae69204" />
    <HandShake D1003_FlowReference="238cbef2-ec8d-486d-837c-81f671424cae" />
    <HandShake D1003_FlowReference="8dd35617-fc0f-40ba-9439-d8272ad5a294" />
  </HandShakes D1005_SenderOrgID="SWBS">
  <MessageCount="1000" />
  <HandShake D1003_FlowReference="50bdb6dc-7aed-4392-bf3e-ff3ae90efe73" />
  <MessageCount="10" XMLDocLength="3456" />
</Document>
```

4.2 CMA Messages in detail

The web service operates in an asynchronous manner and is designed to implement long running transactions for the message/response sequences. A Document submitted to the CMA for processing can contain many messages. Each message sent to the CMA and sent back from the CMA must contain a globally unique ID referred to as the Message ID or 'MID'. The Message ID is 16 digits long, the first 6 of which must start with the participants market ID and the seventh should be a '0'. For licensed provider 'PARTIC' an example of valid Message IDs could be PARTIC0000000001, PARTIC0000000002 and PARTIC0999999999. If a message is submitted to the CMA with a duplicate ID it will not be processed.

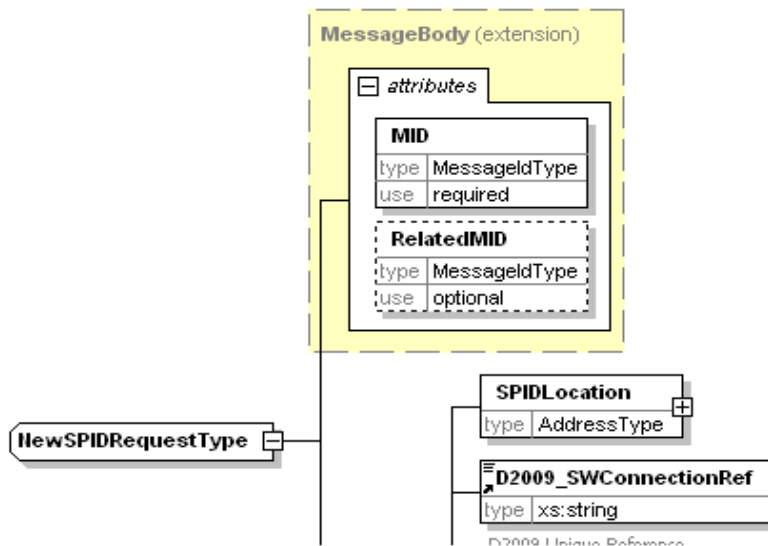

Figure 4 Schema showing the MID and RelatedMID attributes

When the CMA generates messages in response to an incoming message and replies to the original participant the **RelatedMID** field will be populated with the incoming messages original **MID**.

For example, if PARTIC submits message PARTIC0000000001, the CMA will send back a confirmation (or error) when the message has been processed which will have a new MID (CMA0000000000000) and with RelatedMID= PARTIC0000000001.

4.3 Submission of document

A document Submission must consist of valid Header and Messages elements as shown in the schema diagram below.

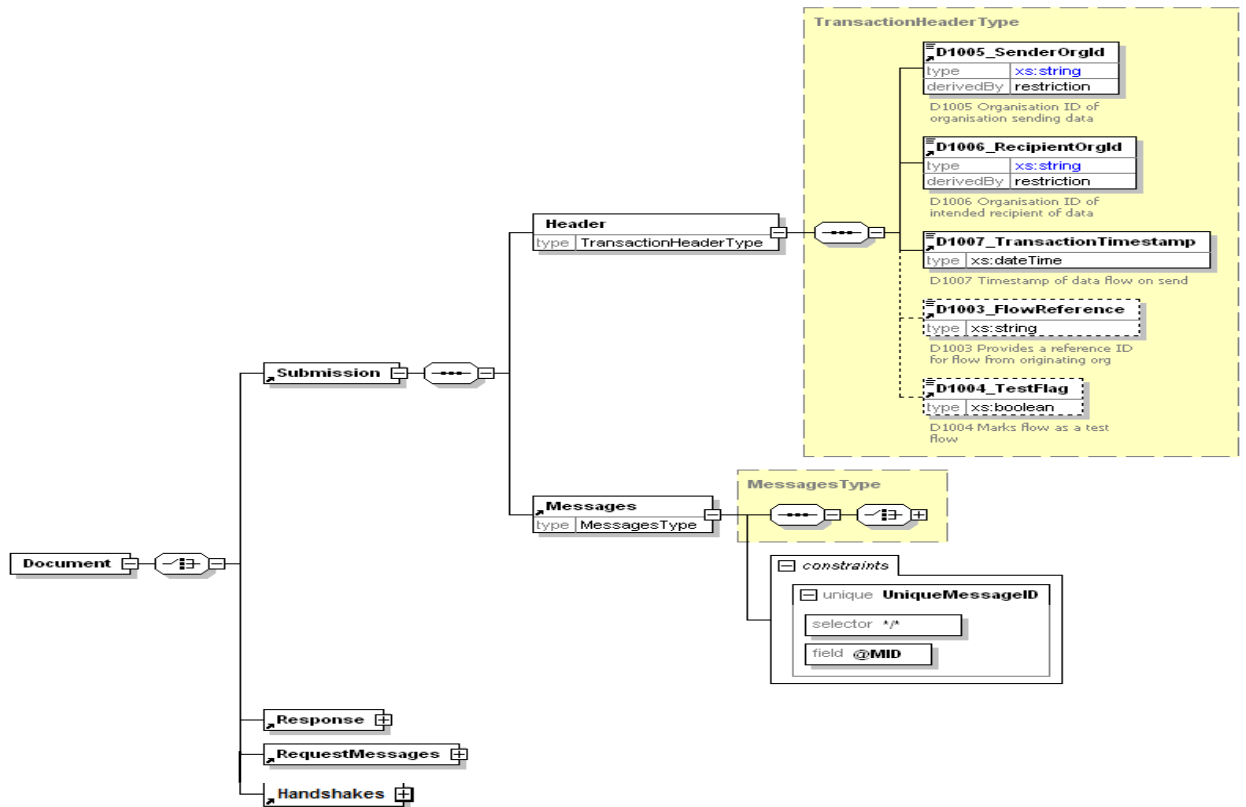

4.4 Requesting New Messages

In order to request response messages from the CMA a participant must submit a RequestMessages element and include the maximum number of messages that they wish to receive. The messages returned will be new messages and any messages that the participant has asked to be reissued.

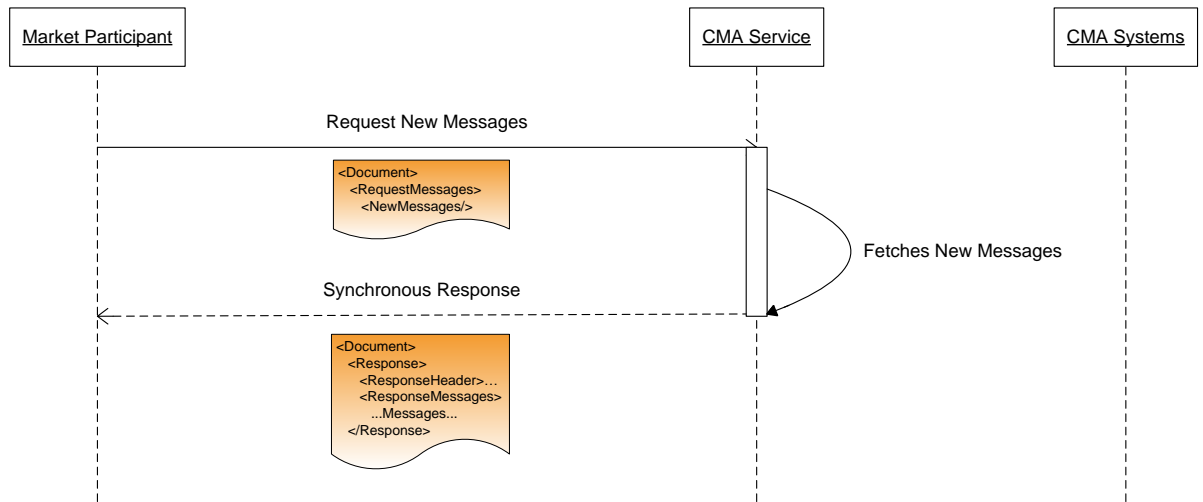

4.5 Handling Optional Data

If a field is designated as optional in the schema it should not be included in a message if it is not to be updated. If it is included in the message the CMA will update the value stored in the Central Systems. If for instance a Boolean is optional and an empty tag is sent, this would be invalid XML. In the case of fields which are strings (text) an empty tag will be interpreted as an empty string and that value overwritten in the Central Systems database with an empty string.

Addresses are treated differently. If the Address is specified then Central Systems will overwrite the entire address with the data supplied, so if there are missing tags those fields would be interpreted as null fields and overwritten in the Central Systems database. This avoids possible errors occurring by merging partial address information.

Appendix A – Web Services Definition Language (WSDL)

The latest current version may be obtained from the CMA in .wsdl (text) file format. The text below is for reference only and should not be copied from this document.

```
<?xml version="1.0" encoding="utf-8"?>
<wsdl:definitions xmlns:soap="http://schemas.xmlsoap.org/wsdl/soap/"
xmlns:tm="http://microsoft.com/wsdl/mime/textMatching/"
xmlns:soapenc="http://schemas.xmlsoap.org/soap/encoding/"
xmlns:mime="http://schemas.xmlsoap.org/wsdl/mime/" xmlns:tns="urn:bridgeall-
com:cmaservice" xmlns:i0="urn:bridgeall-com:cmaservice:data:v3"
xmlns:s="http://www.w3.org/2001/XMLSchema"
xmlns:soap12="http://schemas.xmlsoap.org/wsdl/soap12/"
xmlns:http="http://schemas.xmlsoap.org/wsdl/http/" targetNamespace="urn:bridgeall-
com:cmaservice" xmlns:wsdl="http://schemas.xmlsoap.org/wsdl/">
  <wsdl:import namespace="urn:bridgeall-com:cmaservice:data:v3"
location="XML\CMAData_V3.xsd" />
  <wsdl:types>
    <s:schema elementFormDefault="qualified" targetNamespace="urn:bridgeall-
com:cmaservice">
      <s:import schemaLocation="XML\CMAData_V3.xsd" namespace="urn:bridgeall-
com:cmaservice:data:v3" />
      <s:element name="SubmitDocument">
        <s:complexType>
          <s:sequence>
            <s:element minOccurs="0" maxOccurs="1" ref="i0:Document" />
          </s:sequence>
        </s:complexType>
      </s:element>
      <s:element name="SubmitDocumentResponse">
        <s:complexType>
          <s:sequence>
            <s:element minOccurs="0" maxOccurs="1" ref="i0:Document" />
          </s:sequence>
        </s:complexType>
      </s:element>
    </s:schema>
  </wsdl:types>
  <wsdl:message name="SubmitDocumentSoapIn">
    <wsdl:part name="parameters" element="tns:SubmitDocument" />
  </wsdl:message>
  <wsdl:message name="SubmitDocumentSoapOut">
    <wsdl:part name="parameters" element="tns:SubmitDocumentResponse" />
  </wsdl:message>
  <wsdl:portType name="ServiceSoap">
    <wsdl:operation name="SubmitDocument">
      <wsdl:input message="tns:SubmitDocumentSoapIn" />
      <wsdl:output message="tns:SubmitDocumentSoapOut" />
    </wsdl:operation>
  </wsdl:portType>
  <wsdl:binding name="ServiceSoap" type="tns:ServiceSoap">
    <soap:binding transport="http://schemas.xmlsoap.org/soap/http" />
    <wsdl:operation name="SubmitDocument">
      <soap:operation soapAction="urn:bridgeall-com:cmaservice/SubmitDocument"
style="document" />
      <wsdl:input>
        <soap:body use="literal" />
      </wsdl:input>
      <wsdl:output>
        <soap:body use="literal" />
      </wsdl:output>
    </wsdl:operation>
  </wsdl:binding>
  <wsdl:binding name="ServiceSoap12" type="tns:ServiceSoap">
    <soap12:binding transport="http://schemas.xmlsoap.org/soap/http" />
    <wsdl:operation name="SubmitDocument">
      <soap12:operation soapAction="urn:bridgeall-com:cmaservice/SubmitDocument"
style="document" />
      <wsdl:input>
```

```
<soap12:body use="literal" />
</wsdl:input>
<wsdl:output>
  <soap12:body use="literal" />
</wsdl:output>
</wsdl:operation>
</wsdl:binding>
<wsdl:service name="Service">
  <wsdl:port name="ServiceSoap" binding="tns:ServiceSoap">
    <soap:address location="http://localhost:12357/Service.asmx" />
  </wsdl:port>
  <wsdl:port name="ServiceSoap12" binding="tns:ServiceSoap12">
    <soap12:address location="http://localhost:12357/Service.asmx" />
  </wsdl:port>
</wsdl:service>
</wsdl:definitions>
```

Appendix B – XML Schema Documentation

The latest current version may be obtained from the CMA in .xsd (text) file format. The documentation below is for version [V3] of the schema.

Elements	Complex types	Simple types
D1003 FlowReference	AddressType	AllocationMethodType
D1005 SenderOrgId	CancelRegistrationNotificationOutType	CancellationCodeType
D1006 RecipientOrgId	CancelRegistrationNotificationType	CryptographicHashAlgorithm
D1007 TransactionTimestamp	CancelRegistrationOutType	CustomerClassificationType
D1008 DataItemRef	CancelRegistrationType	CustomerNameType
D1009 DuplicateMessageID	ChargeableMeterUpdateType	decimal18
D2001 SPID	ConnectionCompleteType	DisconnectionReconnectionType
D2002 ServiceCategory	CustomerNameUpdatedNotificationType	FarmCroftType
D2003 Schedule3	DisconnectionType	MessageIDType
D2004 ExemptCustomerFlag	DiscontinueDPIDType	MeterLocationCodeType
D2005 CustomerClassification	DPIDNotificationType	MeterTreatmentType
D2006 29e	DPIDUpdateType	NewConnectionType
D2007 LargeVolAgreement	DPMeterReadType	percentage
D2008 SICCode	LPMeterUpdateType	ReadFrequencyType
D2009 SWConnectionRef	MessageBody	ReadType
D2010 YVe	MessagesType	ReturnCodeType
D2011 RateableValue	MeterAssociationType	ServiceCategoryType
D2012 SurfaceArea	MeterDisAssociationType	SReadReasonCodeType
D2013 ConnectionDate	MeterNetworkAssociationType	pe
D2014 FarmCroft	MeterReadNotificationType	string32
D2015 SPIDVacant	MeterReadType	TETreatmentType
D2016 PropertyDrainage	MeterSWAPDetailsNotificationType	UARNAbsenceCodeType
D2017 RoadDrainage	MeterSWAPDetailsType	pe
D2018 TroughsDrinkingBowls	MeterSwapNotificationType	UPRNAbsenceCodeType
D2020 OutsideTaps	MeterSwapType	pe
D2023 NewConnectionType	MeterUpdateNotificationType	
D2024 Unmeasurable	MeterUpdateType	
D2025 DisconnectionReconnection	NewLPSPIDNotificationType	
D2027 CustomerName	NewSPIDNotificationType	
D2028 CustomerNameType	NewSPIDRequestType	
D2029 MeteredBuildingWater	NotificationType	
D2030 MeteredBuildingWaterEffectiveDate	NotifyRSDType	
D2031 VacancyChangeFlag	PartialRegistrationApplicationType	
D2032 LPChallengedVacancyApplicationFlag	PostcodeType	
D2033 AccreditedEntityInstall	PremisesSpecialArrangementsUpdateNotificationType	
D2034 AllocationMethod	PremisesSpecialArrangementsUpdateType	
D2035 MainSPID	RegistrationStartType	
D2036 SubSPID	ResponseMessagesType	
D2041 PcentExemption	Schedule3UpdateType	
D3001 MeterId	ServiceElementUpdateNotificationType	
D3002 ChargeableMeterSize	SewerageServiceElementUpdateNotificationType	
D3003 PhysicalMeterSize	SewerageSPIDDataType	

D3004_NrDigits	SpecialArrangementsUpdateNotificationType
D3005_SewerageChargeableMeterSize	SpecialArrangementsUpdateType
D3006_SubMeterId	T003.1_RegistrationApplicationType
D3007_ReturnToSewerAllowance	T004.0_NewMeterType
D3008_MeterRead	T004.1_NewMeterNotificationType
D3009_MeterReadDate	T004.3_VirtualMeterType
D3010_MeterReadType	T006.0_LPWaterSPIDUpdateType
D3011_MeterReadFrequency	T006.1_LPSewerageSPIDUpdateType
D3012_ReRead	T006.2_WaterSPIDUpdateType
D3013_MeterMake	T006.3_SewerageSPIDUpdateType
D3014_ManufacturerMeterSerialNr	T006.4_WaterSPIDNotificationType
D3015_datalogger_SW	T006.5_SewerageSPIDNotificationType
D3016_datalogger_NonSW	T007.0_WaterConnectionCompleteType
D3017_GISX	T009.4_NotificationType
D3018_GISY	T012.0_MiscSPIDUpdateType
D3019_GISZFreeDescriptor	T012.1_ServiceElementUpdateType
D3020_Rollover_Indicator	T012.3_SewerageServiceElementUpdateType
D3021_Rollover_Flag	T016.0_UnmeasurableDeclarationType
D3022_MeterTreatment	T032.0_CreateUpdateCustomerNameType
D3023_AccreditedEntityInstall	T032.1_CustomerNameUpdatedType
D3024_MDVol	T033.0_MeteredBuilding
D3025_MeterLocationCode	T033.1_MeteredBuildingUpdate
D3026_MeterNetworkAssociation	T034.0_VacSchemeApplication
D3027_MainMeterId	T034.1_VacSchemeGracePeriodNotification
D3028_SReadReasonCode	T034.2_VacSchemeGraceEndNotification
D3029_SReadRemedialWorkIndicator	T034.3_VacSchemeApplicationNotification
D4001_Orqld	T034.4_VacSchemeApplicationConfirmationOrCancellation
D4002_RegistrationStartDate	T034.5_VacSchemeApplicationConfirmationOrCancellationNotification
D4003_Comment	T035.0_TradeabilityNotification
D4004_ReturnCode	T035.1_TradeabilityNotification
D4005_CancellationCode	TEUpdateType
D4006_EffectiveFrom	TransactionHeaderType
D4007_DateOfEvidence	UARNTType
D4008_CryptographicHash	UpdateMeterLocationNotificationType
D4009_CryptographicHashAlgorithm	UpdateMeterLocationType
D4010_VacancyChangeGracePeriod	UpdateSAAReferenceNumberUPRNNotificationType
D4011_WaterSPLPOrql	UpdateSAAReferenceNumberUPRNTType
D4012_SewerageSPLPOrql	UPRNTType
D5001_FreeDescriptor	WaterSPIDDataType
D6001_DPID	
D6002_TeYVe	
D6003_CDV	
D6004_sBODL	
D6005_TSSL	
D6006_Ot	
D6007_St	
D6009_Non-	

[domesticAllowance](#)
[D6010 SDTIndicator](#)
[D6011 TETreatment](#)
[D6012 PcentAllowance](#)
[D6013 FixedAllowance](#)
[Document](#)
[Handshakes](#)
[Messages](#)
[RequestMessages](#)
[Response](#)
[ResponseMessages](#)
[Submission](#)

element **D1003_FlowReference**

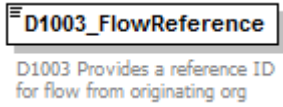
diagram										
namespace	urn:bridgeall-com:cmaservice:data:v3									
type	restriction of xs:string									
properties	content simple									
used by	complexType TransactionHeaderType									
facets	<table border="1"> <thead> <tr> <th>Kind</th> <th>Value</th> <th>annotation</th> </tr> </thead> <tbody> <tr> <td>minLength</td> <td>1</td> <td></td> </tr> <tr> <td>pattern</td> <td>([a-z][A-Z][0-9][\-._]*)</td> <td></td> </tr> </tbody> </table>	Kind	Value	annotation	minLength	1		pattern	([a-z][A-Z][0-9][\-._]*)	
Kind	Value	annotation								
minLength	1									
pattern	([a-z][A-Z][0-9][\-._]*)									
annotation	documentation D1003 Provides a reference ID for flow from originating org									
source	<pre> <xs:element name="D1003_FlowReference"> <xs:annotation> <xs:documentation>D1003 Provides a reference ID for flow from originating org</xs:documentation> </xs:annotation> <xs:simpleType> <xs:restriction base="xs:string"> <xs:minLength value="1"/> <xs:pattern value="([a-z][A-Z][0-9][\-._]*)"/> </xs:restriction> </xs:simpleType> </xs:element> </pre>									

element **D1005_SenderOrgId**

diagram	
namespace	urn:bridgeall-com:cmaservice:data:v3
type	restriction of xs:string
properties	content simple

used by	complexType TransactionHeaderType												
facets	<table border="1"> <thead> <tr> <th>Kind</th> <th>Value</th> <th>annotation</th> </tr> </thead> <tbody> <tr> <td>minLength</td> <td>1</td> <td></td> </tr> <tr> <td>maxLength</td> <td>6</td> <td></td> </tr> <tr> <td>pattern</td> <td colspan="2">([a-z][A-Z][0-9][\-\-])*</td> </tr> </tbody> </table>	Kind	Value	annotation	minLength	1		maxLength	6		pattern	([a-z][A-Z][0-9][\-\-])*	
Kind	Value	annotation											
minLength	1												
maxLength	6												
pattern	([a-z][A-Z][0-9][\-\-])*												
annotation	documentation D1005 Organisation ID of organisation sending data												
source	<pre><xs:element name="D1005_SenderOrgId"> <xs:annotation> <xs:documentation>D1005 Organisation ID of organisation sending data</xs:documentation> </xs:annotation> <xs:simpleType> <xs:restriction base="xs:string"> <xs:minLength value="1"/> <xs:maxLength value="6"/> <xs:pattern value="([a-z][A-Z][0-9][\-\-])*/> </xs:restriction> </xs:simpleType> </xs:element></pre>												

element **D1006_RecipientOrgId**

diagram													
namespace	urn:bridgeall-com:cmaservice:data:v3												
type	restriction of xs:string												
properties	content simple												
used by	complexType TransactionHeaderType												
facets	<table border="1"> <thead> <tr> <th>Kind</th> <th>Value</th> <th>annotation</th> </tr> </thead> <tbody> <tr> <td>minLength</td> <td>1</td> <td></td> </tr> <tr> <td>maxLength</td> <td>6</td> <td></td> </tr> <tr> <td>pattern</td> <td colspan="2">([a-z][A-Z][0-9][\-\-])*</td> </tr> </tbody> </table>	Kind	Value	annotation	minLength	1		maxLength	6		pattern	([a-z][A-Z][0-9][\-\-])*	
Kind	Value	annotation											
minLength	1												
maxLength	6												
pattern	([a-z][A-Z][0-9][\-\-])*												
annotation	documentation D1006 Organisation ID of intended recipient of data												
source	<pre><xs:element name="D1006_RecipientOrgId"> <xs:annotation> <xs:documentation>D1006 Organisation ID of intended recipient of data</xs:documentation> </xs:annotation> <xs:simpleType> <xs:restriction base="xs:string"> <xs:minLength value="1"/> <xs:maxLength value="6"/> <xs:pattern value="([a-z][A-Z][0-9][\-\-])*/> </xs:restriction> </xs:simpleType> </xs:element></pre>												

element D1007_TransactionTimestamp

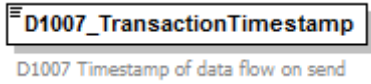
diagram	
namespace	urn:bridgeall-com:cmaservice:data:v3
type	xs:dateTime
properties	content simple
used by	complexType TransactionHeaderType
annotation	documentation D1007 Timestamp of data flow on send
source	<pre><xs:element name="D1007_TransactionTimestamp" type="xs:dateTime"> <xs:annotation> <xs:documentation>D1007 Timestamp of data flow on send</xs:documentation> </xs:annotation> </xs:element></pre>

element D1008_DataItemRef

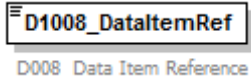
diagram	
namespace	urn:bridgeall-com:cmaservice:data:v3
type	xs:string
properties	content simple
used by	complexType NotificationType
annotation	documentation D008 Data Item Reference
source	<pre><xs:element name="D1008_DataItemRef" type="xs:string"> <xs:annotation> <xs:documentation>D008 Data Item Reference</xs:documentation> </xs:annotation> </xs:element></pre>

element D1009_DuplicateMessageID

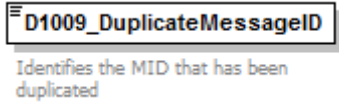
diagram	
namespace	urn:bridgeall-com:cmaservice:data:v3
type	xs:string
properties	content simple
used by	complexType T009.4 NotificationType
annotation	documentation Identifies the MID that has been duplicated
source	<pre><xs:element name="D1009_DuplicateMessageID" type="xs:string"> <xs:annotation> <xs:documentation>Identifies the MID that has been duplicated</xs:documentation> </xs:element></pre>

	<pre></xs:annotation> </xs:element></pre>
--	---

element **D2001_SPID**

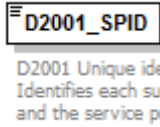
diagram	 <p>D2001 Unique identifier that Identifies each supply point and the service provided</p>												
namespace	urn:bridgeall-com:cmaservice:data:v3												
type	restriction of xs:string												
properties	content simple												
used by	<p>complexType</p> <p>CancelRegistrationNotificationOutType CancelRegistrationNotificationType CancelRegistrationType ChargeableMeterUpdateType ConnectionCompleteType CustomerNameUpdatedNotificationType DisconnectionType DiscontinueDPIDType DPIDNotificationType DPIDUpdateType DPMeterReadType LPMeterUpdateType MeterAssociationType MeterDisAssociationType MeterReadNotificationType MeterReadType MeterSwapNotificationType MeterSwapType MeterUpdateNotificationType MeterUpdateType NewLPSPIDNotificationType NewSPIDNotificationType NewSPIDRequestType NotificationType NotifyRSDType PartialRegistrationApplicationType PremisesSpecialArrangementsUpdateNotificationType PremisesSpecialArrangementsUpdateType RegistrationStartType Schedule3UpdateType ServiceElementUpdateNotificationType SewerageServiceElementUpdateNotificationType SewerageSPIDDataType SpecialArrangementsUpdateNotificationType SpecialArrangementsUpdateType T003.1 RegistrationApplicationType T004.0 NewMeterType T004.1 NewMeterNotificationType T004.3 VirtualMeterType T006.0 LPWaterSPIDUpdateType T006.1 LPsewerageSPIDUpdateType T006.2 WaterSPIDUpdateType T006.3 SewerageSPIDUpdateType T006.4 WaterSPIDNotificationType T006.5 SewerageSPIDNotificationType T007.0 WaterConnectionCompleteType T012.0 MiscSPIDUpdateType T012.1 ServiceElementUpdateType T012.3 SewerageServiceElementUpdateType T016.0 UnmeasureableDeclarationType T032.0 CreateUpdateCustomerNameType T032.1 CustomerNameUpdatedType T033.0 MeteredBuilding T033.1 MeteredBuildingUpdate T034.0 VacSchemeApplication T034.1 VacSchemeGracePeriodNotification T034.2 VacSchemeGraceEndNotification T034.3 VacSchemeApplicationNotification T034.4 VacSchemeApplicationConfirmationOrCancellation T034.5 VacSchemeApplicationConfirmationOrCancellationNotification T035.0 TradeabilityNotification T035.1 TradeabilityNotification TEUpdateType UpdateMeterLocationNotificationType UpdateMeterLocationType UpdateSAARefereceNumberUPRNNotificationType UpdateSAARefereceNumberUPRNTType WaterSPIDDataType</p>												
facets	<table border="1"> <thead> <tr> <th>Kind</th> <th>Value</th> <th>annotation</th> </tr> </thead> <tbody> <tr> <td>minLength</td> <td>12</td> <td></td> </tr> <tr> <td>maxLength</td> <td>12</td> <td></td> </tr> <tr> <td>pattern</td> <td>([0-9])*</td> <td></td> </tr> </tbody> </table>	Kind	Value	annotation	minLength	12		maxLength	12		pattern	([0-9])*	
Kind	Value	annotation											
minLength	12												
maxLength	12												
pattern	([0-9])*												
annotation	<p>documentation</p> <p>D2001 Unique identifier that Identifies each supply point and the service provided</p>												
source	<pre><xs:element name="D2001_SPID"> <xs:annotation> <xs:documentation>D2001 Unique identifier that Identifies each supply point and the service provided </xs:documentation> </xs:annotation> </xs:simpleType></pre>												

	<pre> <xs:restriction base="xs:string"> <xs:maxLength value="12"/> <xs:minLength value="12"/> <xs:pattern value="([0-9])*"/> </xs:restriction> </xs:simpleType> </xs:element> </pre>
--	--

element **D2002_ServiceCategory**

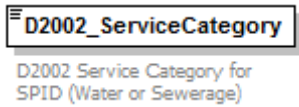
diagram										
namespace	urn:bridgeall-com:cmaservice:data:v3									
type	ServiceCategoryType									
properties	content simple									
facets	<table border="1"> <thead> <tr> <th>Kind</th> <th>Value</th> <th>annotation</th> </tr> </thead> <tbody> <tr> <td>enumeration</td> <td>01</td> <td></td> </tr> <tr> <td>enumeration</td> <td>02</td> <td></td> </tr> </tbody> </table>	Kind	Value	annotation	enumeration	01		enumeration	02	
Kind	Value	annotation								
enumeration	01									
enumeration	02									
annotation	documentation D2002 Service Category for SPID (Water or Sewerage)									
source	<pre> <xs:element name="D2002_ServiceCategory" type="ServiceCategoryType"> <xs:annotation> <xs:documentation>D2002 Service Category for SPID (Water or Sewerage) </xs:documentation> </xs:annotation> </xs:element> </pre>									

element **D2003_Schedule3**

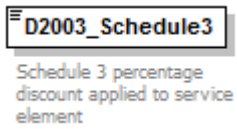
diagram																
namespace	urn:bridgeall-com:cmaservice:data:v3															
type	percentage															
properties	content simple															
used by	<table border="1"> <thead> <tr> <th>complexType</th> <th></th> </tr> </thead> <tbody> <tr> <td>Schedule3UpdateType</td> <td></td> </tr> <tr> <td>SpecialArrangementsUpdateNotificationType</td> <td></td> </tr> <tr> <td>SpecialArrangementsUpdateType</td> <td></td> </tr> </tbody> </table>	complexType		Schedule3UpdateType		SpecialArrangementsUpdateNotificationType		SpecialArrangementsUpdateType								
complexType																
Schedule3UpdateType																
SpecialArrangementsUpdateNotificationType																
SpecialArrangementsUpdateType																
facets	<table border="1"> <thead> <tr> <th>Kind</th> <th>Value</th> <th>annotation</th> </tr> </thead> <tbody> <tr> <td>minInclusive</td> <td>0</td> <td></td> </tr> <tr> <td>maxInclusive</td> <td>100</td> <td></td> </tr> <tr> <td>totalDigits</td> <td>5</td> <td></td> </tr> <tr> <td>fractionDigits</td> <td>2</td> <td></td> </tr> </tbody> </table>	Kind	Value	annotation	minInclusive	0		maxInclusive	100		totalDigits	5		fractionDigits	2	
Kind	Value	annotation														
minInclusive	0															
maxInclusive	100															
totalDigits	5															
fractionDigits	2															
annotation	documentation Schedule 3 percentage discount applied to service element															
source	<pre> <xs:element name="D2003_Schedule3" type="percentage"> <xs:annotation> <xs:documentation>Schedule 3 percentage discount applied to service element</xs:documentation> </xs:annotation> </xs:element> </pre>															

	</xs:element>
--	---------------

element D2004_ ExemptCustomerFlag

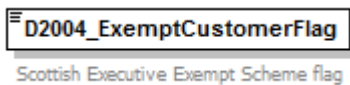
diagram	 <p>D2004_ ExemptCustomerFlag Scottish Executive Exempt Scheme flag</p>
namespace	urn:bridgeall-com:cmaservice:data:v3
type	xs:boolean
properties	content simple
used by	complexTypes PremisesSpecialArrangementsUpdateNotificationType PremisesSpecialArrangementsUpdateType SpecialArrangementsUpdateNotificationType
annotation	documentation Scottish Executive Exempt Scheme flag
source	<pre><xs:element name="D2004_ ExemptCustomerFlag" type="xs:boolean"> <xs:annotation> <xs:documentation>Scottish Executive Exempt Scheme flag</xs:documentation> </xs:annotation> </xs:element></pre>

element D2005_ CustomerClassification

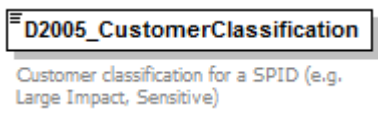
diagram	 <p>D2005_ CustomerClassification Customer classification for a SPID (e.g. Large Impact, Sensitive)</p>												
namespace	urn:bridgeall-com:cmaservice:data:v3												
type	CustomerClassificationType												
properties	content simple												
used by	complexTypes SewerageSPIDDataType T006.0 LPWaterSPIDUpdateType T006.1 LPsewerageSPIDUpdateType T012.0 MiscSPIDUpdateType WaterSPIDDataType												
facets	<table border="1"> <thead> <tr> <th>Kind</th> <th>Value</th> <th>annotation</th> </tr> </thead> <tbody> <tr> <td>enumeration</td> <td>LIC</td> <td></td> </tr> <tr> <td>enumeration</td> <td>SST</td> <td></td> </tr> <tr> <td>enumeration</td> <td>NA</td> <td></td> </tr> </tbody> </table>	Kind	Value	annotation	enumeration	LIC		enumeration	SST		enumeration	NA	
Kind	Value	annotation											
enumeration	LIC												
enumeration	SST												
enumeration	NA												
annotation	documentation Customer classification for a SPID (e.g. Large Impact, Sensitive)												
source	<pre><xs:element name="D2005_ CustomerClassification" type="CustomerClassificationType"> <xs:annotation> <xs:documentation>Customer classification for a SPID (e.g. Large Impact, Sensitive)</xs:documentation> </xs:annotation> </xs:element></pre>												

element D2006_29e

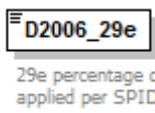
diagram	 <p>29e percentage discount applied per SPID</p>															
namespace	urn:bridgeall-com:cmaservice:data:v3															
type	percentage															
properties	content simple															
used by	complexTypes SpecialArrangementsUpdateNotificationType SpecialArrangementsUpdateType															
facets	<table border="1"> <thead> <tr> <th>Kind</th> <th>Value</th> <th>annotation</th> </tr> </thead> <tbody> <tr> <td>minInclusive</td> <td>0</td> <td></td> </tr> <tr> <td>maxInclusive</td> <td>100</td> <td></td> </tr> <tr> <td>totalDigits</td> <td>5</td> <td></td> </tr> <tr> <td>fractionDigits</td> <td>2</td> <td></td> </tr> </tbody> </table>	Kind	Value	annotation	minInclusive	0		maxInclusive	100		totalDigits	5		fractionDigits	2	
Kind	Value	annotation														
minInclusive	0															
maxInclusive	100															
totalDigits	5															
fractionDigits	2															
annotation	documentation 29e percentage discount applied per SPID															
source	<pre><xs:element name="D2006_29e" type="percentage"> <xs:annotation> <xs:documentation>29e percentage discount applied per SPID</xs:documentation> </xs:annotation> </xs:element></pre>															

element D2007_LargeVolAgreement

diagram	 <p>Large-User Volume Agreement (LUVA) for SPID</p>
namespace	urn:bridgeall-com:cmaservice:data:v3
type	xs:boolean
properties	content simple
used by	complexTypes SpecialArrangementsUpdateNotificationType SpecialArrangementsUpdateType
annotation	documentation Large-User Volume Agreement (LUVA) for SPID
source	<pre><xs:element name="D2007_LargeVolAgreement" type="xs:boolean"> <xs:annotation> <xs:documentation>Large-User Volume Agreement (LUVA) for SPID</xs:documentation> </xs:annotation> </xs:element></pre>

element D2008_SICCode

diagram	 <p>SIC Code applicable to a SPID</p>
namespace	urn:bridgeall-com:cmaservice:data:v3
type	restriction of xs:string

properties	content simple
used by	complexTypes SewerageSPIDDataType T006.0 LPWaterSPIDUpdateType T006.1 LPsewerageSPIDUpdateType T012.0 MiscSPIDUpdateType WaterSPIDDataType
facets	Kind Value annotation maxLength 16 pattern ([a-z][A-Z][0-9])*
annotation	documentation SIC Code applicable to a SPID
source	<pre><xs:element name="D2008_SICCode"> <xs:annotation> <xs:documentation>SIC Code applicable to a SPID</xs:documentation> </xs:annotation> <xs:simpleType> <xs:restriction base="xs:string"> <xs:maxLength value="16"/> <xs:pattern value="([a-z][A-Z][0-9])*" /> </xs:restriction> </xs:simpleType> </xs:element></pre>

element **D2009_SWConnectionRef**

diagram	
namespace	urn:bridgeall-com:cmaservice:data:v3
type	restriction of xs:string
properties	content simple
used by	complexTypes NewLPSPIDNotificationType NewSPIDNotificationType NewSPIDRequestType
facets	Kind Value annotation maxLength 32 pattern ([a-z][A-Z][0-9][\V])*
annotation	documentation D2009 Unique Reference wholesaler uses to identify new connections under installation
source	<pre><xs:element name="D2009_SWConnectionRef"> <xs:annotation> <xs:documentation>D2009 Unique Reference wholesaler uses to identify new connections under installation</xs:documentation> </xs:annotation> <xs:simpleType> <xs:restriction base="xs:string"> <xs:maxLength value="32"/> <xs:pattern value="([a-z][A-Z][0-9][\V])*" /> </xs:restriction> </xs:simpleType> </xs:element></pre>

element **D2010_YVe**

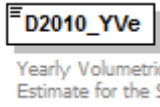
diagram	
namespace	urn:bridgeall-com:cmaservice:data:v3
type	restriction of xs:decimal
properties	content simple
used by	complexTypees LPMeterUpdateType T004.1 NewMeterNotificationType T004.3 VirtualMeterType
facets	Kind Value annotation minInclusive 0 maxInclusive 999999999999
annotation	documentation Yearly Volumetric Usage Estimate for the SPID
source	<pre><xs:element name="D2010_YVe"> <xs:annotation> <xs:documentation>Yearly Volumetric Usage Estimate for the SPID</xs:documentation> </xs:annotation> <xs:simpleType> <xs:restriction base="xs:decimal"> <xs:minInclusive value="0"/> <xs:maxInclusive value="999999999999"/> </xs:restriction> </xs:simpleType> </xs:element></pre>

element **D2011_RateableValue**

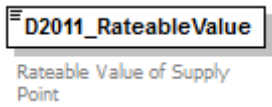
diagram	
namespace	urn:bridgeall-com:cmaservice:data:v3
type	restriction of xs:decimal
properties	content simple
used by	complexTypees SewerageSPIDDataType T006.0 LPWaterSPIDUpdateType T006.1 LPsewerageSPIDUpdateType T006.4 WaterSPIDNotificationType T006.5 SewerageSPIDNotificationType T012.1 ServiceElementUpdateType WaterSPIDDataType
facets	Kind Value annotation minInclusive 0 maxInclusive 2000000000.99 totalDigits 12 fractionDigits 2
annotation	documentation Rateable Value of Supply Point
source	<pre><xs:element name="D2011_RateableValue"> <xs:annotation> <xs:documentation>Rateable Value of Supply Point</xs:documentation> </xs:annotation> <xs:simpleType> <xs:restriction base="xs:decimal"> <xs:totalDigits value="12"/> </xs:restriction> </xs:simpleType> </xs:element></pre>

	<pre> <xs:fractionDigits value="2"/> <xs:minInclusive value="0"/> <xs:maxInclusive value="2000000000.99"/> </xs:restriction> </xs:simpleType> </xs:element> </pre>
--	--

element D2012_SurfaceArea

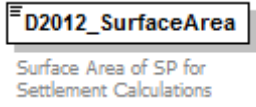
diagram																
namespace	urn:bridgeall-com:cmaservice:data:v3															
type	restriction of xs:decimal															
properties	content simple															
used by	complexType SewerageSPIDDataType															
facets	<table border="1"> <thead> <tr> <th>Kind</th> <th>Value</th> <th>annotation</th> </tr> </thead> <tbody> <tr> <td>minInclusive</td> <td>0</td> <td></td> </tr> <tr> <td>maxInclusive</td> <td>9999999999.99</td> <td></td> </tr> <tr> <td>totalDigits</td> <td>12</td> <td></td> </tr> <tr> <td>fractionDigits</td> <td>2</td> <td></td> </tr> </tbody> </table>	Kind	Value	annotation	minInclusive	0		maxInclusive	9999999999.99		totalDigits	12		fractionDigits	2	
Kind	Value	annotation														
minInclusive	0															
maxInclusive	9999999999.99															
totalDigits	12															
fractionDigits	2															
annotation	documentation Surface Area of SP for Settlement Calculations															
source	<pre> <xs:element name="D2012_SurfaceArea"> <xs:annotation> <xs:documentation>Surface Area of SP for Settlement Calculations</xs:documentation> </xs:annotation> <xs:simpleType> <xs:restriction base="xs:decimal"> <xs:totalDigits value="12"/> <xs:fractionDigits value="2"/> <xs:minInclusive value="0"/> <xs:maxInclusive value="9999999999.99"/> </xs:restriction> </xs:simpleType> </xs:element> </pre>															

element D2013_ConnectionDate

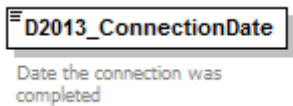
diagram	
namespace	urn:bridgeall-com:cmaservice:data:v3
type	xs:date
properties	content simple
used by	complexType ConnectionCompleteType T007.0 WaterConnectionCompleteType T035.0 TradeabilityNotification T035.1 TradeabilityNotification
annotation	documentation Date the connection was completed
source	<pre> <xs:element name="D2013_ConnectionDate" type="xs:date"> </pre>

	<pre><xs:annotation> <xs:documentation>Date the connection was completed</xs:documentation> </xs:annotation> </xs:element></pre>
--	--

element D2014_FarmCroft

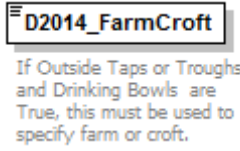
diagram													
namespace	urn:bridgeall-com:cmaservice:data:v3												
type	FarmCroftType												
properties	content simple												
used by	complexTypes T006.2 WaterSPIDUpdateType T006.4 WaterSPIDNotificationType T012.1 ServiceElementUpdateType WaterSPIDDataType												
facets	<table border="0"> <tr> <td>Kind</td> <td>Value</td> <td>annotation</td> </tr> <tr> <td>enumeration</td> <td>FARM</td> <td></td> </tr> <tr> <td>enumeration</td> <td>CROFT</td> <td></td> </tr> <tr> <td>enumeration</td> <td>NA</td> <td></td> </tr> </table>	Kind	Value	annotation	enumeration	FARM		enumeration	CROFT		enumeration	NA	
Kind	Value	annotation											
enumeration	FARM												
enumeration	CROFT												
enumeration	NA												
annotation	documentation If Outside Taps or Troughs and Drinking Bowls are True, this must be used to specify farm or croft.												
source	<pre><xs:element name="D2014_FarmCroft" type="FarmCroftType"> <xs:annotation> <xs:documentation>If Outside Taps or Troughs and Drinking Bowls are True, this must be used to specify farm or croft.</xs:documentation> </xs:annotation> </xs:element></pre>												

element D2015_SPIDVacant

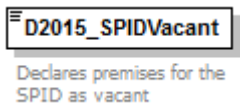
diagram	
namespace	urn:bridgeall-com:cmaservice:data:v3
type	xs:boolean
properties	content simple
used by	complexTypes ServiceElementUpdateNotificationType T012.1 ServiceElementUpdateType
annotation	documentation Declares premises for the SPID as vacant
source	<pre><xs:element name="D2015_SPIDVacant" type="xs:boolean"> <xs:annotation> <xs:documentation>Declares premises for the SPID as vacant</xs:documentation> </xs:annotation> </xs:element></pre>

element **D2016_PropertyDrainage**

diagram	
namespace	urn:bridgeall-com:cmaservice:data:v3
type	xs:boolean
properties	content simple
used by	complexTypes SewerageServiceElementUpdateNotificationType SewerageSPIDDataType T006.3 SewerageSPIDUpdateType T006.5 SewerageSPIDNotificationType T012.3 SewerageServiceElementUpdateType
annotation	documentation Does SPID have this Service Element
source	<pre><xs:element name="D2016_PropertyDrainage" type="xs:boolean"> <xs:annotation> <xs:documentation>Does SPID have this Service Element</xs:documentation> </xs:annotation> </xs:element></pre>

element **D2017_RoadDrainage**

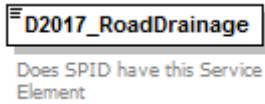
diagram	
namespace	urn:bridgeall-com:cmaservice:data:v3
type	xs:boolean
properties	content simple
used by	complexTypes SewerageServiceElementUpdateNotificationType SewerageSPIDDataType T006.3 SewerageSPIDUpdateType T006.5 SewerageSPIDNotificationType T012.3 SewerageServiceElementUpdateType
annotation	documentation Does SPID have this Service Element
source	<pre><xs:element name="D2017_RoadDrainage" type="xs:boolean"> <xs:annotation> <xs:documentation>Does SPID have this Service Element</xs:documentation> </xs:annotation> </xs:element></pre>

element **D2018_TroughsDrinkingBowls**

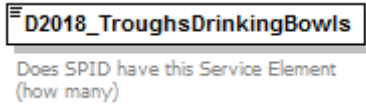
diagram	
namespace	urn:bridgeall-com:cmaservice:data:v3
type	restriction of xs:short
properties	content simple
used by	complexTypes T006.2 WaterSPIDUpdateType T006.4 WaterSPIDNotificationType T012.1 ServiceElementUpdateType WaterSPIDDataType
facets	Kind Value annotation minInclusive 0 maxInclusive 999

annotation	documentation Does SPID have this Service Element (how many)
source	<pre> <xs:element name="D2018_TroughsDrinkingBowls"> <xs:annotation> <xs:documentation>Does SPID have this Service Element (how many)</xs:documentation> </xs:annotation> <xs:simpleType> <xs:restriction base="xs:short"> <xs:minInclusive value="0"/> <xs:maxInclusive value="999"/> </xs:restriction> </xs:simpleType> </xs:element> </pre>

element D2020_OutsideTaps

diagram										
namespace	urn:bridgeall-com:cmaservice:data:v3									
type	restriction of xs:short									
properties	content simple									
used by	complexTypes T006.2 WaterSPIDUpdateType T006.4 WaterSPIDNotificationType T012.1 ServiceElementUpdateType WaterSPIDDataType									
facets	<table border="1"> <thead> <tr> <th>Kind</th> <th>Value</th> <th>annotation</th> </tr> </thead> <tbody> <tr> <td>minInclusive</td> <td>0</td> <td></td> </tr> <tr> <td>maxInclusive</td> <td>999</td> <td></td> </tr> </tbody> </table>	Kind	Value	annotation	minInclusive	0		maxInclusive	999	
Kind	Value	annotation								
minInclusive	0									
maxInclusive	999									
annotation	documentation Does SPID have this Service Element (how many)									
source	<pre> <xs:element name="D2020_OutsideTaps"> <xs:annotation> <xs:documentation>Does SPID have this Service Element (how many)</xs:documentation> </xs:annotation> <xs:simpleType> <xs:restriction base="xs:short"> <xs:minInclusive value="0"/> <xs:maxInclusive value="999"/> </xs:restriction> </xs:simpleType> </xs:element> </pre>									

element D2023_NewConnectionType

diagram	
namespace	urn:bridgeall-com:cmaservice:data:v3
type	NewConnectionType
properties	content simple
used by	complexTypes NewLPSPIDNotificationType NewSPIDNotificationType NewSPIDRequestType

facets	Kind enumeration	Value NEW	annotation
	enumeration	GS	
	enumeration	CU	
source	<pre><xs:element name="D2023_NewConnectionType" type="NewConnectionType"> <xs:annotation> <xs:documentation/> </xs:annotation> </xs:element></pre>		

element D2024_Unmeasurable

diagram			
namespace	urn:bridgeall-com:cmaservice:data:v3		
type	xs:boolean		
properties	content simple		
used by	complexType	T016.0_UnmeasurableDeclarationType WaterSPIDDataType	
annotation	documentation		
source	<pre><xs:element name="D2024_Unmeasurable" type="xs:boolean"> <xs:annotation> <xs:documentation> </xs:documentation> </xs:annotation> </xs:element></pre>		

element D2025_DisconnectionReconnection

diagram			
namespace	urn:bridgeall-com:cmaservice:data:v3		
type	DisconnectionReconnectionType		
properties	content simple		
used by	complexType	DisconnectionType	
facets	Kind enumeration	Value REC	annotation
	enumeration	TDISC	
	enumeration	PDISC	
	enumeration	DEREG	
source	<pre><xs:element name="D2025_DisconnectionReconnection" type="DisconnectionReconnectionType"> <xs:annotation> <xs:documentation/> </xs:annotation> </xs:element></pre>		

element **D2027_CustomerName**

diagram													
namespace	urn:bridgeall-com:cmaservice:data:v3												
type	restriction of xs:string												
properties	content simple												
used by	complexTypes CustomerNameUpdatedNotificationType T032.0 CreateUpdateCustomerNameType T032.1 CustomerNameUpdatedType												
facets	<table border="1"> <thead> <tr> <th>Kind</th> <th>Value</th> <th>annotation</th> </tr> </thead> <tbody> <tr> <td>minLength</td> <td>1</td> <td></td> </tr> <tr> <td>maxLength</td> <td>255</td> <td></td> </tr> <tr> <td>pattern</td> <td>([^\t\n\r])*</td> <td></td> </tr> </tbody> </table>	Kind	Value	annotation	minLength	1		maxLength	255		pattern	([^\t\n\r])*	
Kind	Value	annotation											
minLength	1												
maxLength	255												
pattern	([^\t\n\r])*												
annotation	documentation D2027 Customer Name that owns a SPID												
source	<pre> <xs:element name="D2027_CustomerName"> <xs:annotation> <xs:documentation>D2027 Customer Name that owns a SPID</xs:documentation> </xs:annotation> <xs:simpleType> <xs:restriction base="xs:string"> <xs:maxLength value="255"/> <xs:minLength value="1"/> <xs:pattern value="([^\t\n\r])*"/> </xs:restriction> </xs:simpleType> </xs:element> </pre>												

element **D2028_CustomerNameType**

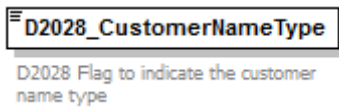
diagram										
namespace	urn:bridgeall-com:cmaservice:data:v3									
type	CustomerNameType									
properties	content simple									
used by	complexTypes CustomerNameUpdatedNotificationType T032.0 CreateUpdateCustomerNameType T032.1 CustomerNameUpdatedType									
facets	<table border="1"> <thead> <tr> <th>Kind</th> <th>Value</th> <th>annotation</th> </tr> </thead> <tbody> <tr> <td>enumeration</td> <td>Customer</td> <td></td> </tr> <tr> <td>enumeration</td> <td>Developer</td> <td></td> </tr> </tbody> </table>	Kind	Value	annotation	enumeration	Customer		enumeration	Developer	
Kind	Value	annotation								
enumeration	Customer									
enumeration	Developer									
annotation	documentation D2028 Flag to indicate the customer name type									
source	<pre> <xs:element name="D2028_CustomerNameType" type="CustomerNameType"> <xs:annotation> <xs:documentation>D2028 Flag to indicate the customer name type</xs:documentation> </xs:annotation> </pre>									

	</xs:element>
--	---------------

element D2029_MeteredBuildingWater

diagram	
namespace	urn:bridgeall-com:cmaservice:data:v3
type	xs:boolean
properties	content simple
used by	complexTypees T033.0 MeteredBuilding T033.1 MeteredBuildingUpdate
annotation	documentation D2029 Flag to indicate if the site is a metered building construction site
source	<pre><xs:element name="D2029_MeteredBuildingWater" type="xs:boolean"> <xs:annotation> <xs:documentation>D2029 Flag to indicate if the site is a metered building construction site</xs:documentation> </xs:annotation> </xs:element></pre>

element D2030_MeteredBuildingWaterEffectiveDate

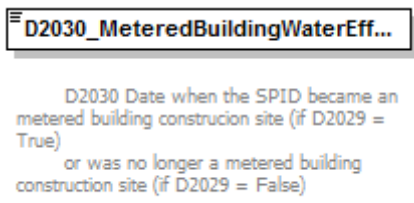
diagram	
namespace	urn:bridgeall-com:cmaservice:data:v3
type	xs:date
properties	content simple
used by	complexTypees T033.0 MeteredBuilding T033.1 MeteredBuildingUpdate
annotation	documentation D2030 Date when the SPID became an metered building construction site (if D2029 = True) or was no longer a metered building construction site (if D2029 = False)
source	<pre><xs:element name="D2030_MeteredBuildingWaterEffectiveDate" type="xs:date"> <xs:annotation> <xs:documentation> D2030 Date when the SPID became an metered building construction site (if D2029 = True) or was no longer a metered building construction site (if D2029 = False) </xs:documentation> </xs:annotation> </xs:element></pre>

element D2031_VacancyChangeFlag

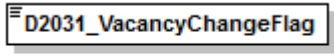
diagram	 <p>Declares that a vacancy change application should proceed (if set to True), or should be cancelled (if set to False).</p>
namespace	urn:bridgeall-com:cmaservice:data:v3
type	xs:boolean
properties	content simple
used by	complexTypes T034.4_VacSchemeApplicationConfirmationOrCancellation T034.5_VacSchemeApplicationConfirmationOrCancellationNotification
annotation	documentation Declares that a vacancy change application should proceed (if set to True), or should be cancelled (if set to False).
source	<pre><xs:element name="D2031_VacancyChangeFlag" type="xs:boolean"> <xs:annotation> <xs:documentation> Declares that a vacancy change application should proceed (if set to True), or should be cancelled (if set to False). </xs:documentation> </xs:annotation> </xs:element></pre>

element D2032_LPChallengedVacancyApplicationFlag

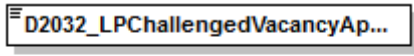
diagram	 <p>Declares that an LP has raised a challenge against an SW vacancy change application.</p>
namespace	urn:bridgeall-com:cmaservice:data:v3
type	xs:boolean
properties	content simple
used by	complexTypes T034.4_VacSchemeApplicationConfirmationOrCancellation T034.5_VacSchemeApplicationConfirmationOrCancellationNotification
annotation	documentation Declares that an LP has raised a challenge against an SW vacancy change application.
source	<pre><xs:element name="D2032_LPChallengedVacancyApplicationFlag" type="xs:boolean"> <xs:annotation> <xs:documentation> Declares that an LP has raised a challenge against an SW vacancy change application. </xs:documentation> </xs:annotation> </xs:element></pre>

element **D2033_AccreditedEntityInstall**

diagram	
namespace	urn:bridgeall-com:cmaservice:data:v3
type	xs:boolean
properties	content simple
used by	complexType T007.0_WaterConnectionCompleteType
annotation	documentation Accredited Entity Install - Allows Scottish Water to notify the CMA when an operation has been carried out by an accredited installer
source	<pre><xs:element name="D2033_AccreditedEntityInstall" type="xs:boolean"> <xs:annotation> <xs:documentation>Accredited Entity Install - Allows Scottish Water to notify the CMA when an operation has been carried out by an accredited installer</xs:documentation> </xs:annotation> </xs:element></pre>

element **D2034_AllocationMethod**

diagram																
namespace	urn:bridgeall-com:cmaservice:data:v3															
type	AllocationMethodType															
properties	content simple															
used by	complexType NewLPSPIDNotificationType NewSPIDNotificationType															
facets	<table border="0"> <tr> <td>Kind</td> <td>enumeration</td> <td>Value</td> <td>Associated SPID</td> <td>annotation</td> </tr> <tr> <td></td> <td>enumeration</td> <td>Rotation</td> <td></td> <td></td> </tr> <tr> <td></td> <td>enumeration</td> <td>N/A</td> <td></td> <td></td> </tr> </table>	Kind	enumeration	Value	Associated SPID	annotation		enumeration	Rotation				enumeration	N/A		
Kind	enumeration	Value	Associated SPID	annotation												
	enumeration	Rotation														
	enumeration	N/A														
annotation	documentation Allocation Method of the new connection															
source	<pre><xs:element name="D2034_AllocationMethod" type="AllocationMethodType"> <xs:annotation> <xs:documentation>Allocation Method of the new connection</xs:documentation> </xs:annotation> </xs:element></pre>															

element **D2035_MainSPID**

diagram	
namespace	urn:bridgeall-com:cmaservice:data:v3

type	restriction of xs:string												
properties	content simple												
used by	complexType MeterNetworkAssociationType												
facets	<table border="1"> <thead> <tr> <th>Kind</th> <th>Value</th> <th>annotation</th> </tr> </thead> <tbody> <tr> <td>minLength</td> <td>12</td> <td></td> </tr> <tr> <td>maxLength</td> <td>12</td> <td></td> </tr> <tr> <td>pattern</td> <td>([0-9])*</td> <td></td> </tr> </tbody> </table>	Kind	Value	annotation	minLength	12		maxLength	12		pattern	([0-9])*	
Kind	Value	annotation											
minLength	12												
maxLength	12												
pattern	([0-9])*												
annotation	documentation SPID for a Main Meter in a meter network												
source	<pre> <xs:element name="D2035_MainSPID"> <xs:annotation> <xs:documentation>SPID for a Main Meter in a meter network</xs:documentation> </xs:annotation> <xs:simpleType> <xs:restriction base="xs:string"> <xs:maxLength value="12"/> <xs:minLength value="12"/> <xs:pattern value="([0-9])*"/> </xs:restriction> </xs:simpleType> </xs:element> </pre>												

element **D2036_SubSPID**

diagram													
namespace	urn:bridgeall-com:cmaservice:data:v3												
type	restriction of xs:string												
properties	content simple												
used by	complexType MeterNetworkAssociationType												
facets	<table border="1"> <thead> <tr> <th>Kind</th> <th>Value</th> <th>annotation</th> </tr> </thead> <tbody> <tr> <td>minLength</td> <td>12</td> <td></td> </tr> <tr> <td>maxLength</td> <td>12</td> <td></td> </tr> <tr> <td>pattern</td> <td>([0-9])*</td> <td></td> </tr> </tbody> </table>	Kind	Value	annotation	minLength	12		maxLength	12		pattern	([0-9])*	
Kind	Value	annotation											
minLength	12												
maxLength	12												
pattern	([0-9])*												
annotation	documentation SPID for a Sub-Meter in a meter network												
source	<pre> <xs:element name="D2036_SubSPID"> <xs:annotation> <xs:documentation>SPID for a Sub-Meter in a meter network</xs:documentation> </xs:annotation> <xs:simpleType> <xs:restriction base="xs:string"> <xs:maxLength value="12"/> <xs:minLength value="12"/> <xs:pattern value="([0-9])*"/> </xs:restriction> </xs:simpleType> </xs:element> </pre>												

element D2041_PcentExemption

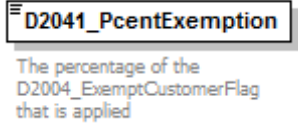
diagram																
namespace	urn:bridgeall-com:cmaservice:data:v3															
type	percentage															
properties	content simple															
used by	complexTypes PremisesSpecialArrangementsUpdateNotificationType PremisesSpecialArrangementsUpdateType SpecialArrangementsUpdateNotificationType															
facets	<table border="1"> <thead> <tr> <th>Kind</th> <th>Value</th> <th>annotation</th> </tr> </thead> <tbody> <tr> <td>minInclusive</td> <td>0</td> <td></td> </tr> <tr> <td>maxInclusive</td> <td>100</td> <td></td> </tr> <tr> <td>totalDigits</td> <td>5</td> <td></td> </tr> <tr> <td>fractionDigits</td> <td>2</td> <td></td> </tr> </tbody> </table>	Kind	Value	annotation	minInclusive	0		maxInclusive	100		totalDigits	5		fractionDigits	2	
Kind	Value	annotation														
minInclusive	0															
maxInclusive	100															
totalDigits	5															
fractionDigits	2															
annotation	documentation The percentage of the D2004_ExemptCustomerFlag that is applied															
source	<pre><xs:element name="D2041_PcentExemption" type="percentage"> <xs:annotation> <xs:documentation>The percentage of the D2004_ExemptCustomerFlag that is applied</xs:documentation> </xs:annotation> </xs:element></pre>															

element D3001_MeterId

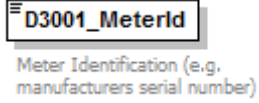
diagram													
namespace	urn:bridgeall-com:cmaservice:data:v3												
type	string32												
properties	content simple												
used by	complexTypes ChargeableMeterUpdateType DPMeterReadType LPMeterUpdateType MeterAssociationType MeterDisAssociationType MeterReadNotificationType MeterReadType MeterSWAPDetailsNotificationType MeterSWAPDetailsType MeterUpdateNotificationType MeterUpdateType T004.0_NewMeterType T004.1_NewMeterNotificationType T004.3_VirtualMeterType UpdateMeterLocationNotificationType UpdateMeterLocationType												
facets	<table border="1"> <thead> <tr> <th>Kind</th> <th>Value</th> <th>annotation</th> </tr> </thead> <tbody> <tr> <td>minLength</td> <td>1</td> <td></td> </tr> <tr> <td>maxLength</td> <td>32</td> <td></td> </tr> <tr> <td>pattern</td> <td>[(^, \t\n\r)]*</td> <td></td> </tr> </tbody> </table>	Kind	Value	annotation	minLength	1		maxLength	32		pattern	[(^, \t\n\r)]*	
Kind	Value	annotation											
minLength	1												
maxLength	32												
pattern	[(^, \t\n\r)]*												
annotation	documentation Meter Identification (e.g. manufacturers serial number)												
source	<pre><xs:element name="D3001_MeterId" type="string32"> <xs:annotation> <xs:documentation>Meter Identification (e.g. manufacturers serial number)</xs:documentation> </xs:annotation> </xs:element></pre>												

element D3002_ChargeableMeterSize

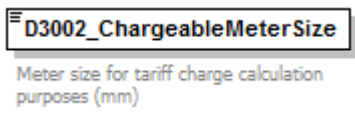
diagram										
namespace	urn:bridgeall-com:cmaservice:data:v3									
type	restriction of xs:short									
properties	content simple									
used by	complexTypes ChargeableMeterUpdateType T004.0 NewMeterType T004.1 NewMeterNotificationType T004.3 VirtualMeterType									
facets	<table border="0"> <tr> <td>Kind</td> <td>Value</td> <td>annotation</td> </tr> <tr> <td>minInclusive</td> <td>0</td> <td></td> </tr> <tr> <td>maxInclusive</td> <td>9999</td> <td></td> </tr> </table>	Kind	Value	annotation	minInclusive	0		maxInclusive	9999	
Kind	Value	annotation								
minInclusive	0									
maxInclusive	9999									
annotation	documentation Meter size for tariff charge calculation purposes (mm)									
source	<pre><xs:element name="D3002_ChargeableMeterSize"> <xs:annotation> <xs:documentation>Meter size for tariff charge calculation purposes (mm)</xs:documentation> </xs:annotation> <xs:simpleType> <xs:restriction base="xs:short"> <xs:minInclusive value="0"/> <xs:maxInclusive value="9999"/> </xs:restriction> </xs:simpleType> </xs:element></pre>									

element D3003_PhysicalMeterSize

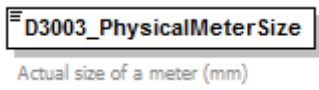
diagram										
namespace	urn:bridgeall-com:cmaservice:data:v3									
type	restriction of xs:short									
properties	content simple									
used by	complexTypes MeterUpdateNotificationType MeterUpdateType T004.0 NewMeterType T004.1 NewMeterNotificationType T004.3 VirtualMeterType									
facets	<table border="0"> <tr> <td>Kind</td> <td>Value</td> <td>annotation</td> </tr> <tr> <td>minInclusive</td> <td>1</td> <td></td> </tr> <tr> <td>maxInclusive</td> <td>9999</td> <td></td> </tr> </table>	Kind	Value	annotation	minInclusive	1		maxInclusive	9999	
Kind	Value	annotation								
minInclusive	1									
maxInclusive	9999									
annotation	documentation Actual size of a meter (mm)									
source	<pre><xs:element name="D3003_PhysicalMeterSize"> <xs:annotation> <xs:documentation>Actual size of a meter (mm)</xs:documentation> </xs:annotation> <xs:simpleType> <xs:restriction base="xs:short"> <xs:minInclusive value="1"/> <xs:maxInclusive value="9999"/> </xs:restriction> </xs:simpleType> </xs:element></pre>									

	<pre></xs:simpleType> </xs:element></pre>
--	---

element D3004_NrDigits

diagram										
namespace	urn:bridgeall-com:cmaservice:data:v3									
type	restriction of xs:short									
properties	content simple									
used by	complexTypes MeterUpdateNotificationType MeterUpdateType T004.0 NewMeterType T004.1 NewMeterNotificationType T004.3 VirtualMeterType									
facets	<table border="1"> <thead> <tr> <th>Kind</th> <th>Value</th> <th>annotation</th> </tr> </thead> <tbody> <tr> <td>minInclusive</td> <td>2</td> <td></td> </tr> <tr> <td>maxInclusive</td> <td>13</td> <td></td> </tr> </tbody> </table>	Kind	Value	annotation	minInclusive	2		maxInclusive	13	
Kind	Value	annotation								
minInclusive	2									
maxInclusive	13									
annotation	documentation The number of digits on the meter register									
source	<pre><xs:element name="D3004_NrDigits"> <xs:annotation> <xs:documentation>The number of digits on the meter register</xs:documentation> </xs:annotation> <xs:simpleType> <xs:restriction base="xs:short"> <xs:minInclusive value="2"/> <xs:maxInclusive value="13"/> </xs:restriction> </xs:simpleType> </xs:element></pre>									

element D3005_SewerageChargeableMeterSize

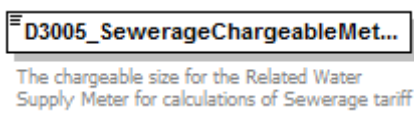
diagram										
namespace	urn:bridgeall-com:cmaservice:data:v3									
type	restriction of xs:short									
properties	content simple									
used by	complexTypes ChargeableMeterUpdateType T004.0 NewMeterType T004.1 NewMeterNotificationType T004.3 VirtualMeterType									
facets	<table border="1"> <thead> <tr> <th>Kind</th> <th>Value</th> <th>annotation</th> </tr> </thead> <tbody> <tr> <td>minInclusive</td> <td>0</td> <td></td> </tr> <tr> <td>maxInclusive</td> <td>9999</td> <td></td> </tr> </tbody> </table>	Kind	Value	annotation	minInclusive	0		maxInclusive	9999	
Kind	Value	annotation								
minInclusive	0									
maxInclusive	9999									
annotation	documentation The chargeable size for the Related Water Supply Meter for calculations of Sewerage tariff									
source	<pre><xs:element name="D3005_SewerageChargeableMeterSize"> <xs:annotation> <xs:documentation>The chargeable size for the Related Water Supply Meter for calculations of Sewerage tariff</xs:documentation> </xs:annotation> <xs:simpleType></pre>									

	<pre> <xs:restriction base="xs:short"> <xs:minInclusive value="0"/> <xs:maxInclusive value="9999"/> </xs:restriction> </xs:simpleType> </xs:element> </pre>
--	---

element D3006_SubMeterId

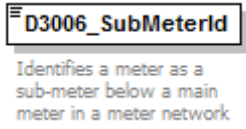
diagram													
namespace	urn:bridgeall-com:cmaservice:data:v3												
type	restriction of xs:string												
properties	content simple												
used by	complexType MeterNetworkAssociationType												
facets	<table border="1"> <thead> <tr> <th>Kind</th> <th>Value</th> <th>annotation</th> </tr> </thead> <tbody> <tr> <td>minLength</td> <td>1</td> <td></td> </tr> <tr> <td>maxLength</td> <td>32</td> <td></td> </tr> <tr> <td>pattern</td> <td>([^\t\n\r])*</td> <td></td> </tr> </tbody> </table>	Kind	Value	annotation	minLength	1		maxLength	32		pattern	([^\t\n\r])*	
Kind	Value	annotation											
minLength	1												
maxLength	32												
pattern	([^\t\n\r])*												
annotation	documentation Identifies a meter as a sub-meter below a main meter in a meter network												
source	<pre> <xs:element name="D3006_SubMeterId"> <xs:annotation> <xs:documentation>Identifies a meter as a sub-meter below a main meter in a meter network</xs:documentation> </xs:annotation> <xs:simpleType> <xs:restriction base="xs:string"> <xs:minLength value="1"/> <xs:maxLength value="32"/> <xs:pattern value="([^\t\n\r])*"/> </xs:restriction> </xs:simpleType> </xs:element> </pre>												

element D3007_ReturnToSewerAllowance

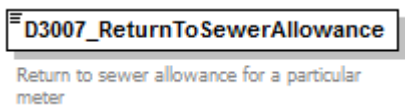
diagram													
namespace	urn:bridgeall-com:cmaservice:data:v3												
type	percentage												
properties	content simple												
used by	complexType ChargeableMeterUpdateType T004.0 NewMeterType T004.1 NewMeterNotificationType T004.3 VirtualMeterType												
facets	<table border="1"> <thead> <tr> <th>Kind</th> <th>Value</th> <th>annotation</th> </tr> </thead> <tbody> <tr> <td>minInclusive</td> <td>0</td> <td></td> </tr> <tr> <td>maxInclusive</td> <td>100</td> <td></td> </tr> <tr> <td>totalDigits</td> <td>5</td> <td></td> </tr> </tbody> </table>	Kind	Value	annotation	minInclusive	0		maxInclusive	100		totalDigits	5	
Kind	Value	annotation											
minInclusive	0												
maxInclusive	100												
totalDigits	5												

	fractionDigits 2
annotation	documentation Return to sewer allowance for a particular meter
source	<xs:element name="D3007_ReturnToSewerAllowance" type="percentage"> <xs:annotation> <xs:documentation>Return to sewer allowance for a particular meter</xs:documentation> </xs:annotation> </xs:element>

element D3008_MeterRead

diagram	
namespace	urn:bridgeall-com:cmaservice:data:v3
type	restriction of xs:decimal
properties	content simple
used by	complexTypees DPMeterReadType MeterReadNotificationType MeterReadType MeterSWAPDetailsNotificationType MeterSWAPDetailsType
facets	Kind Value annotation minInclusive 0 maxInclusive 9999999999999 fractionDigits 0
annotation	documentation Register read from a meter
source	<xs:element name="D3008_MeterRead"> <xs:annotation> <xs:documentation>Register read from a meter</xs:documentation> </xs:annotation> <xs:simpleType> <xs:restriction base="xs:decimal"> <xs:minInclusive value="0"/> <xs:maxInclusive value="9999999999999"/> <xs:fractionDigits value="0"/> </xs:restriction> </xs:simpleType> </xs:element>

element D3009_MeterReadDate

diagram	
namespace	urn:bridgeall-com:cmaservice:data:v3
type	xs:date
properties	content simple
used by	complexTypees DPMeterReadType MeterReadNotificationType MeterReadType MeterSWAPDetailsNotificationType MeterSWAPDetailsType
annotation	documentation Date meter was read
source	<xs:element name="D3009_MeterReadDate" type="xs:date"> <xs:annotation>

	<pre><xs:documentation>Date meter was read </xs:documentation> </xs:annotation> </xs:element></pre>
--	---

element D3010_MeterReadType

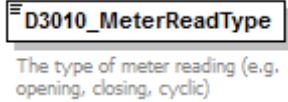
diagram																																					
namespace	urn:bridgeall-com:cmaservice:data:v3																																				
type	ReadType																																				
properties	content simple																																				
used by	complexTypes DPMeterReadType MeterReadNotificationType MeterReadType MeterSWAPDetailsNotificationType MeterSWAPDetailsType																																				
facets	<table border="1"> <thead> <tr> <th>Kind</th> <th>Value</th> <th>annotation</th> </tr> </thead> <tbody> <tr><td>enumeration</td><td>O</td><td></td></tr> <tr><td>enumeration</td><td>E</td><td></td></tr> <tr><td>enumeration</td><td>I</td><td></td></tr> <tr><td>enumeration</td><td>F</td><td></td></tr> <tr><td>enumeration</td><td>C</td><td></td></tr> <tr><td>enumeration</td><td>U</td><td></td></tr> <tr><td>enumeration</td><td>T</td><td></td></tr> <tr><td>enumeration</td><td>X</td><td></td></tr> <tr><td>enumeration</td><td>Y</td><td></td></tr> <tr><td>enumeration</td><td>R</td><td></td></tr> <tr><td>enumeration</td><td>S</td><td></td></tr> </tbody> </table>	Kind	Value	annotation	enumeration	O		enumeration	E		enumeration	I		enumeration	F		enumeration	C		enumeration	U		enumeration	T		enumeration	X		enumeration	Y		enumeration	R		enumeration	S	
Kind	Value	annotation																																			
enumeration	O																																				
enumeration	E																																				
enumeration	I																																				
enumeration	F																																				
enumeration	C																																				
enumeration	U																																				
enumeration	T																																				
enumeration	X																																				
enumeration	Y																																				
enumeration	R																																				
enumeration	S																																				
annotation	documentation The type of meter reading (e.g. opening, closing, cyclic)																																				
source	<pre><xs:element name="D3010_MeterReadType" type="ReadType"> <xs:annotation> <xs:documentation>The type of meter reading (e.g. opening, closing, cyclic)</xs:documentation> </xs:annotation> </xs:element></pre>																																				

element D3011_MeterReadFrequency

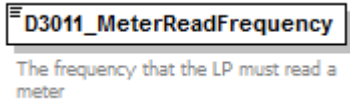
diagram													
namespace	urn:bridgeall-com:cmaservice:data:v3												
type	ReadFrequencyType												
properties	content simple												
used by	complexTypes MeterUpdateNotificationType MeterUpdateType T004.0 NewMeterType T004.1 NewMeterNotificationType T004.3 VirtualMeterType												
facets	<table border="1"> <thead> <tr> <th>Kind</th> <th>Value</th> <th>annotation</th> </tr> </thead> <tbody> <tr><td>enumeration</td><td>B</td><td></td></tr> <tr><td>enumeration</td><td>M</td><td></td></tr> <tr><td>enumeration</td><td>N</td><td></td></tr> </tbody> </table>	Kind	Value	annotation	enumeration	B		enumeration	M		enumeration	N	
Kind	Value	annotation											
enumeration	B												
enumeration	M												
enumeration	N												

annotation	documentation The frequency that the LP must read a meter
source	<pre><xs:element name="D3011_MeterReadFrequency" type="ReadFrequencyType"> <xs:annotation> <xs:documentation>The frequency that the LP must read a meter </xs:documentation> </xs:annotation> </xs:element></pre>

element D3012_ReRead

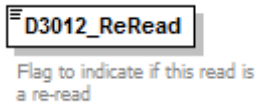
diagram	
namespace	urn:bridgeall-com:cmaservice:data:v3
type	xs:boolean
properties	content simple
used by	complexTypes DPMeterReadType MeterReadNotificationType MeterReadType MeterSwapNotificationType MeterSwapType
annotation	documentation Flag to indicate if this read is a re-read
source	<pre><xs:element name="D3012_ReRead" type="xs:boolean"> <xs:annotation> <xs:documentation>Flag to indicate if this read is a re-read </xs:documentation> </xs:annotation> </xs:element></pre>

element D3013_MeterMake

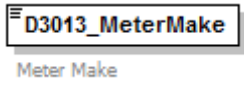
diagram													
namespace	urn:bridgeall-com:cmaservice:data:v3												
type	string32												
properties	content simple												
used by	complexTypes MeterUpdateNotificationType MeterUpdateType T004.0_NewMeterType T004.1_NewMeterNotificationType T004.3_VirtualMeterType												
facets	<table border="1"> <thead> <tr> <th>Kind</th> <th>Value</th> <th>annotation</th> </tr> </thead> <tbody> <tr> <td>minLength</td> <td>1</td> <td></td> </tr> <tr> <td>maxLength</td> <td>32</td> <td></td> </tr> <tr> <td>pattern</td> <td>([^\t\n\r])*</td> <td></td> </tr> </tbody> </table>	Kind	Value	annotation	minLength	1		maxLength	32		pattern	([^\t\n\r])*	
Kind	Value	annotation											
minLength	1												
maxLength	32												
pattern	([^\t\n\r])*												
annotation	documentation Meter Make												
source	<pre><xs:element name="D3013_MeterMake" type="string32"> <xs:annotation> <xs:documentation>Meter Make</xs:documentation> </xs:annotation> </xs:element></pre>												

element **D3014_ManufacturerMeterSerialNr**

diagram	
namespace	urn:bridgeall-com:cmaservice:data:v3
type	string32
properties	content simple
used by	complexTypees MeterUpdateNotificationType MeterUpdateType T004.0_NewMeterType T004.1_NewMeterNotificationType T004.3_VirtualMeterType
facets	Kind Value annotation minLength 1 maxLength 32 pattern <code>([^\t\n\r])*</code>
annotation	documentation Meter Serial Number
source	<pre><xs:element name="D3014_ManufacturerMeterSerialNr" type="string32"> <xs:annotation> <xs:documentation>Meter Serial Number</xs:documentation> </xs:annotation> </xs:element></pre>

element **D3015_datalogger_SW**

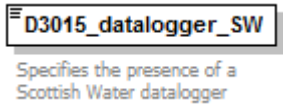
diagram	
namespace	urn:bridgeall-com:cmaservice:data:v3
type	xs:boolean
properties	content simple
used by	complexTypees MeterUpdateNotificationType MeterUpdateType T004.0_NewMeterType T004.1_NewMeterNotificationType
annotation	documentation Specifies the presence of a Scottish Water datalogger
source	<pre><xs:element name="D3015_datalogger_SW" type="xs:boolean"> <xs:annotation> <xs:documentation>Specifies the presence of a Scottish Water datalogger</xs:documentation> </xs:annotation> </xs:element></pre>

element **D3016_datalogger_NonSW**

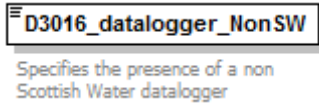
diagram	
namespace	urn:bridgeall-com:cmaservice:data:v3
type	xs:boolean
properties	content simple
used by	complexTypees MeterUpdateNotificationType MeterUpdateType T004.0_NewMeterType T004.1_NewMeterNotificationType

annotation	documentation Specifies the presence of a non Scottish Water datalogger
source	<pre><xs:element name="D3016_datalogger_NonSW" type="xs:boolean"> <xs:annotation> <xs:documentation>Specifies the presence of a non Scottish Water datalogger</xs:documentation> </xs:annotation> </xs:element></pre>

element D3017_GISX

diagram										
namespace	urn:bridgeall-com:cmaservice:data:v3									
type	restriction of xs:decimal									
properties	content simple									
used by	complexTypes MeterUpdateNotificationType MeterUpdateType T004.0 NewMeterType T004.1 NewMeterNotificationType									
facets	<table> <tr> <td>Kind</td> <td>Value</td> <td>annotation</td> </tr> <tr> <td>totalDigits</td> <td>7</td> <td></td> </tr> <tr> <td>fractionDigits</td> <td>1</td> <td></td> </tr> </table>	Kind	Value	annotation	totalDigits	7		fractionDigits	1	
Kind	Value	annotation								
totalDigits	7									
fractionDigits	1									
annotation	documentation Specifies the X coordinate of the location of the meter									
source	<pre><xs:element name="D3017_GISX"> <xs:annotation> <xs:documentation>Specifies the X coordinate of the location of the meter</xs:documentation> </xs:annotation> <xs:simpleType> <xs:restriction base="xs:decimal"> <xs:totalDigits value="7"/> <xs:fractionDigits value="1"/> </xs:restriction> </xs:simpleType> </xs:element></pre>									

element D3018_GISY

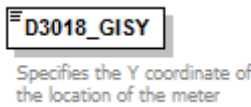
diagram										
namespace	urn:bridgeall-com:cmaservice:data:v3									
type	restriction of xs:decimal									
properties	content simple									
used by	complexTypes MeterUpdateNotificationType MeterUpdateType T004.0 NewMeterType T004.1 NewMeterNotificationType									
facets	<table> <tr> <td>Kind</td> <td>Value</td> <td>annotation</td> </tr> <tr> <td>totalDigits</td> <td>8</td> <td></td> </tr> <tr> <td>fractionDigits</td> <td>1</td> <td></td> </tr> </table>	Kind	Value	annotation	totalDigits	8		fractionDigits	1	
Kind	Value	annotation								
totalDigits	8									
fractionDigits	1									
annotation	documentation Specifies the Y coordinate of the location of the meter									

source	<pre> <xs:element name="D3018_GISY"> <xs:annotation> <xs:documentation>Specifies the Y coordinate of the location of the meter</xs:documentation> </xs:annotation> <xs:simpleType> <xs:restriction base="xs:decimal"> <xs:totalDigits value="8"/> <xs:fractionDigits value="1"/> </xs:restriction> </xs:simpleType> </xs:element> </pre>
--------	--

element **D3019_GISZFreeDescriptor**

diagram							
namespace	urn:bridgeall-com:cmaservice:data:v3						
type	restriction of xs:string						
properties	content simple						
used by	complexTypes MeterUpdateNotificationType T004.0 NewMeterType T004.1 NewMeterNotificationType UpdateMeterLocationNotificationType UpdateMeterLocationType						
facets	<table border="1"> <thead> <tr> <th>Kind</th> <th>Value</th> <th>annotation</th> </tr> </thead> <tbody> <tr> <td>maxLength</td> <td>255</td> <td></td> </tr> </tbody> </table>	Kind	Value	annotation	maxLength	255	
Kind	Value	annotation					
maxLength	255						
annotation	documentation Specifies the Z Free Descriptor of the location of the meter						
source	<pre> <xs:element name="D3019_GISZFreeDescriptor"> <xs:annotation> <xs:documentation>Specifies the Z Free Descriptor of the location of the meter</xs:documentation> </xs:annotation> <xs:simpleType> <xs:restriction base="xs:string"> <xs:maxLength value="255"/> </xs:restriction> </xs:simpleType> </xs:element> </pre>						

element **D3020_Rollover_Indicator**

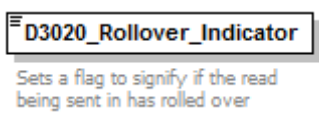
diagram	
namespace	urn:bridgeall-com:cmaservice:data:v3
type	xs:boolean
properties	content simple
used by	complexTypes MeterReadType MeterSWAPDetailsType
annotation	documentation Sets a flag to signify if the read being sent in has rolled over

source	<pre><xs:element name="D3020_Rollover_Indicator" type="xs:boolean"> <xs:annotation> <xs:documentation>Sets a flag to signify if the read being sent in has rolled over </xs:documentation> </xs:annotation> </xs:element></pre>
--------	---

element D3021_Rollover_Flag

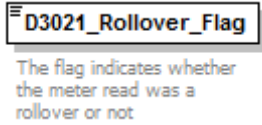
diagram	
namespace	urn:bridgeall-com:cmaservice:data:v3
type	xs:boolean
properties	content simple
used by	complexTypes DPMeterReadType MeterReadNotificationType MeterSWAPDetailsNotificationType
annotation	documentation The flag indicates whether the meter read was a rollover or not
source	<pre><xs:element name="D3021_Rollover_Flag" type="xs:boolean"> <xs:annotation> <xs:documentation>The flag indicates whether the meter read was a rollover or not </xs:documentation> </xs:annotation> </xs:element></pre>

element D3022_MeterTreatment

diagram																						
namespace	urn:bridgeall-com:cmaservice:data:v3																					
type	MeterTreatmentType																					
properties	content simple																					
used by	complexTypes T004.0_NewMeterType T004.1_NewMeterNotificationType																					
facets	<table border="1"> <thead> <tr> <th>Kind</th> <th>Value</th> <th>annotation</th> </tr> </thead> <tbody> <tr> <td>enumeration</td> <td>SWWater</td> <td></td> </tr> <tr> <td>enumeration</td> <td>PrivateWater</td> <td></td> </tr> <tr> <td>enumeration</td> <td>PrivateEffluent</td> <td></td> </tr> <tr> <td>enumeration</td> <td>TankeredEffluent</td> <td></td> </tr> <tr> <td>enumeration</td> <td>LogicalWater</td> <td></td> </tr> <tr> <td>enumeration</td> <td>PseudoWater</td> <td></td> </tr> </tbody> </table>	Kind	Value	annotation	enumeration	SWWater		enumeration	PrivateWater		enumeration	PrivateEffluent		enumeration	TankeredEffluent		enumeration	LogicalWater		enumeration	PseudoWater	
Kind	Value	annotation																				
enumeration	SWWater																					
enumeration	PrivateWater																					
enumeration	PrivateEffluent																					
enumeration	TankeredEffluent																					
enumeration	LogicalWater																					
enumeration	PseudoWater																					
annotation	documentation Meter Treatment Indicator																					
source	<pre><xs:element name="D3022_MeterTreatment" type="MeterTreatmentType"> <xs:annotation> <xs:documentation>Meter Treatment Indicator</xs:documentation> </xs:annotation> </xs:element></pre>																					

element **D3023_AccreditedEntityInstall**

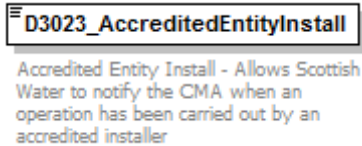
diagram	
namespace	urn:bridgeall-com:cmaservice:data:v3
type	xs:boolean
properties	content simple
used by	complexType T004.0 NewMeterType
annotation	documentation Accredited Entity Install - Allows Scottish Water to notify the CMA when an operation has been carried out by an accredited installer
source	<pre><xs:element name="D3023_AccreditedEntityInstall" type="xs:boolean"> <xs:annotation> <xs:documentation>Accredited Entity Install - Allows Scottish Water to notify the CMA when an operation has been carried out by an accredited installer</xs:documentation> </xs:annotation> </xs:element></pre>

element **D3024_MDVol**

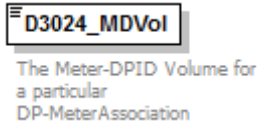
diagram																
namespace	urn:bridgeall-com:cmaservice:data:v3															
type	percentage															
properties	content simple															
used by	complexType MeterAssociationType															
facets	<table border="0"> <thead> <tr> <th>Kind</th> <th>Value</th> <th>annotation</th> </tr> </thead> <tbody> <tr> <td>minInclusive</td> <td>0</td> <td></td> </tr> <tr> <td>maxInclusive</td> <td>100</td> <td></td> </tr> <tr> <td>totalDigits</td> <td>5</td> <td></td> </tr> <tr> <td>fractionDigits</td> <td>2</td> <td></td> </tr> </tbody> </table>	Kind	Value	annotation	minInclusive	0		maxInclusive	100		totalDigits	5		fractionDigits	2	
Kind	Value	annotation														
minInclusive	0															
maxInclusive	100															
totalDigits	5															
fractionDigits	2															
annotation	documentation The Meter-DPID Volume for a particular DP-MeterAssociation															
source	<pre><xs:element name="D3024_MDVol" type="percentage"> <xs:annotation> <xs:documentation>The Meter-DPID Volume for a particular DP- MeterAssociation</xs:documentation> </xs:annotation> </xs:element></pre>															

element **D3025_MeterLocationCode**

diagram	
namespace	urn:bridgeall-com:cmaservice:data:v3
type	MeterLocationCodeType
properties	content simple
used by	complexTypees T004.0_NewMeterType T004.1_NewMeterNotificationType UpdateMeterLocationNotificationType UpdateMeterLocationType
facets	Kind Value annotation enumeration M1 enumeration M2 enumeration M3 enumeration M4
annotation	documentation Meter Location Code
source	<pre><xs:element name="D3025_MeterLocationCode" type="MeterLocationCodeType"> <xs:annotation> <xs:documentation>Meter Location Code</xs:documentation> </xs:annotation> </xs:element></pre>

element **D3026_MeterNetworkAssociation**

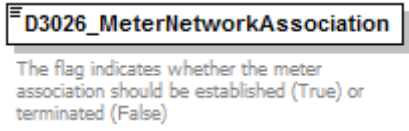
diagram	
namespace	urn:bridgeall-com:cmaservice:data:v3
type	xs:boolean
properties	content simple
used by	complexType MeterNetworkAssociationType
annotation	documentation The flag indicates whether the meter association should be established (True) or terminated (False)
source	<pre><xs:element name="D3026_MeterNetworkAssociation" type="xs:boolean"> <xs:annotation> <xs:documentation>The flag indicates whether the meter association should be established (True) or terminated (False)</xs:documentation> </xs:annotation> </xs:element></pre>

element **D3027_MainMeterId**

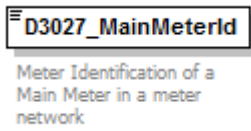
diagram	
namespace	urn:bridgeall-com:cmaservice:data:v3
type	string32

properties	content simple												
used by	complexType MeterNetworkAssociationType												
facets	<table border="1"> <thead> <tr> <th>Kind</th> <th>Value</th> <th>annotation</th> </tr> </thead> <tbody> <tr> <td>minLength</td> <td>1</td> <td></td> </tr> <tr> <td>maxLength</td> <td>32</td> <td></td> </tr> <tr> <td>pattern</td> <td colspan="2">([\^, \t\n\r]*)*</td> </tr> </tbody> </table>	Kind	Value	annotation	minLength	1		maxLength	32		pattern	([\^, \t\n\r]*)*	
Kind	Value	annotation											
minLength	1												
maxLength	32												
pattern	([\^, \t\n\r]*)*												
annotation	documentation Meter Identification of a Main Meter in a meter network												
source	<pre><xs:element name="D3027_MainMeterId" type="string32"> <xs:annotation> <xs:documentation>Meter Identification of a Main Meter in a meter network</xs:documentation> </xs:annotation> </xs:element></pre>												

element D3028_SReadReasonCode

diagram																			
namespace	urn:bridgeall-com:cmaservice:data:v3																		
type	SReadReasonCodeType																		
properties	content simple																		
used by	complexTypes MeterReadNotificationType MeterReadType																		
facets	<table border="1"> <thead> <tr> <th>Kind</th> <th>Value</th> <th>annotation</th> </tr> </thead> <tbody> <tr> <td>enumeration</td> <td>WMD</td> <td></td> </tr> <tr> <td>enumeration</td> <td>NMA</td> <td></td> </tr> <tr> <td>enumeration</td> <td>MNF</td> <td></td> </tr> <tr> <td>enumeration</td> <td>NSA</td> <td></td> </tr> <tr> <td>enumeration</td> <td>PLR</td> <td></td> </tr> </tbody> </table>	Kind	Value	annotation	enumeration	WMD		enumeration	NMA		enumeration	MNF		enumeration	NSA		enumeration	PLR	
Kind	Value	annotation																	
enumeration	WMD																		
enumeration	NMA																		
enumeration	MNF																		
enumeration	NSA																		
enumeration	PLR																		
annotation	documentation Reason code for the S read																		
source	<pre><xs:element name="D3028_SReadReasonCode" type="SReadReasonCodeType"> <xs:annotation> <xs:documentation>Reason code for the S read</xs:documentation> </xs:annotation> </xs:element></pre>																		

element D3029_SReadRemedialWorkIndicator

diagram	
namespace	urn:bridgeall-com:cmaservice:data:v3
type	xs:boolean
properties	content simple
used by	complexTypes MeterReadNotificationType MeterReadType

annotation	documentation The flag indicates whether, or not, the Incoming LP has initiated remedial work to remove the reason for the S read to be required
source	<pre><xs:element name="D3029_SReadRemedialWorkIndicator" type="xs:boolean"> <xs:annotation> <xs:documentation>The flag indicates whether, or not, the Incoming LP has initiated remedial work to remove the reason for the S read to be required</xs:documentation> </xs:annotation> </xs:element></pre>

element D4001_OrgId

diagram													
namespace	urn:bridgeall-com:cmaservice:data:v3												
type	restriction of xs:string												
properties	content simple												
used by	complexTypes CustomerNameUpdatedNotificationType NewSPIDNotificationType NewSPIDRequestType NotifyRSDType												
facets	<table border="0"> <tr> <td>Kind</td> <td>Value</td> <td>annotation</td> </tr> <tr> <td>minLength</td> <td>1</td> <td></td> </tr> <tr> <td>maxLength</td> <td>6</td> <td></td> </tr> <tr> <td>pattern</td> <td colspan="2">([a-zA-Z0-9][\-\-])*</td> </tr> </table>	Kind	Value	annotation	minLength	1		maxLength	6		pattern	([a-zA-Z0-9][\-\-])*	
Kind	Value	annotation											
minLength	1												
maxLength	6												
pattern	([a-zA-Z0-9][\-\-])*												
annotation	documentation D4001 Unique ID for each organisation (SW, Licensed Providers etc) transacting flows with CMA												
source	<pre><xs:element name="D4001_OrgId"> <xs:annotation> <xs:documentation>D4001 Unique ID for each organisation (SW, Licensed Providers etc) transacting flows with CMA</xs:documentation> </xs:annotation> <xs:simpleType> <xs:restriction base="xs:string"> <xs:minLength value="1"/> <xs:maxLength value="6"/> <xs:pattern value="([a-zA-Z0-9][\-\-])*" /> </xs:restriction> </xs:simpleType> </xs:element></pre>												

element D4002_RegistrationStartDate

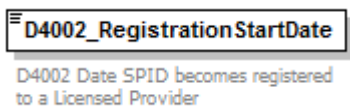
diagram	
namespace	urn:bridgeall-com:cmaservice:data:v3
type	xs:date
properties	content simple
used by	complexTypes NotifyRSDType RegistrationStartType T003.1_RegistrationApplicationType

annotation	documentation D4002 Date SPID becomes registered to a Licensed Provider
source	<pre><xs:element name="D4002_RegistrationStartDate" type="xs:date"> <xs:annotation> <xs:documentation>D4002 Date SPID becomes registered to a Licensed Provider</xs:documentation> </xs:annotation> </xs:element></pre>

element **D4003_Comment**

diagram										
namespace	urn:bridgeall-com:cmaservice:data:v3									
type	restriction of xs:string									
properties	content simple									
used by	complexTypes CancelRegistrationNotificationType CancelRegistrationOutType ChargeableMeterUpdateType DPIDUpdateType MeterUpdateNotificationType MeterUpdateType ServiceElementUpdateNotificationType SewerageServiceElementUpdateNotificationType T012.0_MiscSPIDUpdateType T012.1_ServiceElementUpdateType T012.3_SewerageServiceElementUpdateType T034.0_VacSchemeApplication T034.1_VacSchemeGracePeriodNotification T034.2_VacSchemeGraceEndNotification T034.3_VacSchemeApplicationNotification T034.4_VacSchemeApplicationConfirmationOrCancellation T034.5_VacSchemeApplicationConfirmationOrCancellationNotification									
facets	<table border="1"> <thead> <tr> <th>Kind</th> <th>Value</th> <th>annotation</th> </tr> </thead> <tbody> <tr> <td>maxLength</td> <td>255</td> <td></td> </tr> <tr> <td>whiteSpace</td> <td>preserve</td> <td></td> </tr> </tbody> </table>	Kind	Value	annotation	maxLength	255		whiteSpace	preserve	
Kind	Value	annotation								
maxLength	255									
whiteSpace	preserve									
annotation	documentation Generic text field for (short) comments and notes related to the transaction									
source	<pre><xs:element name="D4003_Comment"> <xs:annotation> <xs:documentation>Generic text field for (short) comments and notes related to the transaction</xs:documentation> </xs:annotation> <xs:simpleType> <xs:restriction base="xs:string"> <xs:maxLength value="255"/> <xs:whiteSpace value="preserve"/> </xs:restriction> </xs:simpleType> </xs:element></pre>									

element **D4004_ReturnCode**

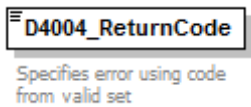
diagram	
namespace	urn:bridgeall-com:cmaservice:data:v3
type	ReturnCodeType

properties	content	simple
used by	complexType	NotificationType T009.4 NotificationType T034.2 VacSchemeGraceEndNotification
facets	Kind	Value annotation
	enumeration	AA
	enumeration	AB
	enumeration	AC
	enumeration	AD
	enumeration	AE
	enumeration	AF
	enumeration	AG
	enumeration	AH
	enumeration	AI
	enumeration	AJ
	enumeration	AK
	enumeration	AL
	enumeration	AM
	enumeration	AN
	enumeration	AO
	enumeration	AP
	enumeration	AQ
	enumeration	AR
	enumeration	AS
	enumeration	AT
	enumeration	AU
	enumeration	AV
	enumeration	AW
	enumeration	AX
	enumeration	AY
	enumeration	AZ
	enumeration	BA
	enumeration	BB
	enumeration	BC
	enumeration	BD
	enumeration	BE
	enumeration	BF
	enumeration	BG
	enumeration	BH
	enumeration	BI
	enumeration	BL
	enumeration	BN
	enumeration	BV
	enumeration	BZ
	enumeration	OK
	enumeration	DA
	enumeration	DB
	enumeration	DC
	enumeration	DD
	enumeration	DE
	enumeration	DF

enumeration	DG
enumeration	DH
enumeration	DI
enumeration	DJ
enumeration	DK
enumeration	DL
enumeration	DM
enumeration	DN
enumeration	DO
enumeration	DP
enumeration	DQ
enumeration	DR
enumeration	DS
enumeration	DT
enumeration	DU
enumeration	DV
enumeration	DW
enumeration	DX
enumeration	DY
enumeration	DZ
enumeration	EA
enumeration	EB
enumeration	EC
enumeration	ED
enumeration	EE
enumeration	EF
enumeration	EG
enumeration	EH
enumeration	EI
enumeration	EJ
enumeration	EK
enumeration	EL
enumeration	EM
enumeration	EN
enumeration	EO
enumeration	EP
enumeration	EQ
enumeration	ER
enumeration	ES
enumeration	ET
enumeration	EU
enumeration	EV
enumeration	EW
enumeration	EX
enumeration	EY
enumeration	EZ
enumeration	FA
enumeration	FB
enumeration	FC

enumeration	FD
enumeration	FE
enumeration	FF
enumeration	FG
enumeration	FH
enumeration	FI
enumeration	FJ
enumeration	FK
enumeration	FL
enumeration	FM
enumeration	FN
enumeration	FO
enumeration	FP
enumeration	FQ
enumeration	FR
enumeration	FS
enumeration	FT
enumeration	FU
enumeration	FV
enumeration	FW
enumeration	FX
enumeration	FY
enumeration	FZ
enumeration	GA
enumeration	GB
enumeration	GC
enumeration	GD
enumeration	GE
enumeration	GF
enumeration	GG
enumeration	GH
enumeration	GI
enumeration	GJ
enumeration	GK
enumeration	GL
enumeration	GM
enumeration	GN
enumeration	GO
enumeration	GP
enumeration	GQ
enumeration	GR
enumeration	GS
enumeration	GT
enumeration	GU
enumeration	GV
enumeration	GW
enumeration	GX
enumeration	GY
enumeration	GZ

enumeration	HA
enumeration	HB
enumeration	HC
enumeration	HD
enumeration	HE
enumeration	HF
enumeration	HG
enumeration	HH
enumeration	HI
enumeration	HJ
enumeration	HK
enumeration	HL
enumeration	HM
enumeration	HN
enumeration	HO
enumeration	HP
enumeration	HQ
enumeration	HR
enumeration	HS
enumeration	HT
enumeration	HU
enumeration	HV
enumeration	HW
enumeration	HX
enumeration	HY
enumeration	HZ
enumeration	IA
enumeration	IB
enumeration	IC
enumeration	ID
enumeration	IE
enumeration	IF
enumeration	IG
enumeration	IH
enumeration	II
enumeration	IJ
enumeration	IK
enumeration	IL
enumeration	IM
enumeration	IN
enumeration	IO
enumeration	IP
enumeration	IQ
enumeration	IR
enumeration	IS
enumeration	IT
enumeration	IU
enumeration	IV
enumeration	IW

enumeration	IX
enumeration	IY
enumeration	IZ
enumeration	JA
enumeration	JB
enumeration	JC
enumeration	JD
enumeration	JE
enumeration	JF
enumeration	JG
enumeration	JH
enumeration	JI
enumeration	JJ
enumeration	JK
enumeration	JL
enumeration	JM
enumeration	JN
enumeration	JO
enumeration	JP
enumeration	JQ
enumeration	JR
enumeration	JS
enumeration	JT
enumeration	JU
enumeration	JV
enumeration	JW
enumeration	JX
enumeration	JY
enumeration	JZ
enumeration	KA
enumeration	KB
enumeration	KC
enumeration	KD
enumeration	KE
enumeration	KF
enumeration	KG
enumeration	KH
enumeration	KI
enumeration	KJ
enumeration	KK
enumeration	KL
enumeration	KM
enumeration	KN
enumeration	KO
enumeration	KP
enumeration	KQ
enumeration	KR
enumeration	KS
enumeration	XA

annotation	documentation Specifies error using code from valid set
source	<pre><xs:element name="D4004_ReturnCode" type="ReturnCodeType"> <xs:annotation> <xs:documentation>Specifies error using code from valid set</xs:documentation> </xs:annotation> </xs:element></pre>

element D4005_CancellationCode

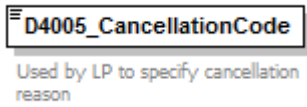
diagram																			
namespace	urn:bridgeall-com:cmaservice:data:v3																		
type	CancellationCodeType																		
properties	content simple																		
used by	complexTypes CancelRegistrationNotificationType CancelRegistrationType																		
facets	<table border="0"> <tr> <td>Kind</td> <td>Value</td> <td>annotation</td> </tr> <tr> <td>enumeration</td> <td>S</td> <td></td> </tr> <tr> <td>enumeration</td> <td>N</td> <td></td> </tr> <tr> <td>enumeration</td> <td>D</td> <td></td> </tr> <tr> <td>enumeration</td> <td>C</td> <td></td> </tr> <tr> <td>enumeration</td> <td>F</td> <td></td> </tr> </table>	Kind	Value	annotation	enumeration	S		enumeration	N		enumeration	D		enumeration	C		enumeration	F	
Kind	Value	annotation																	
enumeration	S																		
enumeration	N																		
enumeration	D																		
enumeration	C																		
enumeration	F																		
annotation	documentation Used by LP to specify cancellation reason																		
source	<pre><xs:element name="D4005_CancellationCode" type="CancellationCodeType"> <xs:annotation> <xs:documentation>Used by LP to specify cancellation reason</xs:documentation> </xs:annotation> </xs:element></pre>																		

element D4006_EffectiveFrom

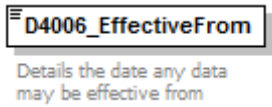
diagram	
namespace	urn:bridgeall-com:cmaservice:data:v3
type	xs:date
properties	content simple
used by	complexTypes ChargeableMeterUpdateType DisconnectionType DiscontinueDPIDType DPIDNotificationType DPIDUpdateType MeterAssociationType MeterDisAssociationType MeterNetworkAssociationType MeterUpdateNotificationType MeterUpdateType PremisesSpecialArrangementsUpdateNotificationType PremisesSpecialArrangementsUpdateType Schedule3UpdateType ServiceElementUpdateNotificationType SewerageServiceElementUpdateNotificationType SpecialArrangementsUpdateNotificationType SpecialArrangementsUpdateType T012.0_MiscSPIDUpdateType T012.1_ServiceElementUpdateType T012.3_SewerageServiceElementUpdateType

	T016.0 UnmeasureableDeclarationType T034.0 VacSchemeApplication T034.1 VacSchemeGracePeriodNotification T034.2 VacSchemeGraceEndNotification T034.3 VacSchemeApplicationNotification T034.4 VacSchemeApplicationConfirmationOrCancellation T034.5 VacSchemeApplicationConfirmationOrCancellationNotification TEUpdateType
annotation	documentation Details the date any data may be effective from
source	<pre><xs:element name="D4006_EffectiveFrom" type="xs:date"> <xs:annotation> <xs:documentation>Details the date any data may be effective from</xs:documentation> </xs:annotation> </xs:element></pre>

element D4007_DateOfEvidence

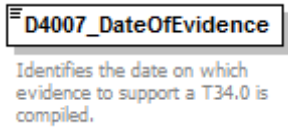
diagram	
namespace	urn:bridgeall-com:cmaservice:data:v3
type	xs:date
properties	content simple
used by	complexTypes T034.0 VacSchemeApplication T034.1 VacSchemeGracePeriodNotification T034.2 VacSchemeGraceEndNotification T034.3 VacSchemeApplicationNotification T034.4 VacSchemeApplicationConfirmationOrCancellation T034.5 VacSchemeApplicationConfirmationOrCancellationNotification
annotation	documentation Identifies the date on which evidence to support a T34.0 is compiled.
source	<pre><xs:element name="D4007_DateOfEvidence" type="xs:date"> <xs:annotation> <xs:documentation>Identifies the date on which evidence to support a T34.0 is compiled.</xs:documentation> </xs:annotation> </xs:element></pre>

element D4008_CryptographicHash

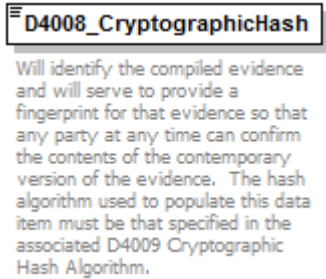
diagram	
namespace	urn:bridgeall-com:cmaservice:data:v3
type	restriction of xs:hexBinary
properties	content simple
used by	complexTypes T034.0 VacSchemeApplication T034.3 VacSchemeApplicationNotification

facets	Kind length whiteSpace	Value 32 collapse	annotation
annotation	documentation Will identify the compiled evidence and will serve to provide a fingerprint for that evidence so that any party at any time can confirm the contents of the contemporary version of the evidence. The hash algorithm used to populate this data item must be that specified in the associated D4009 Cryptographic Hash Algorithm.		
source	<pre><xs:element name="D4008_CryptographicHash"> <xs:annotation> <xs:documentation>Will identify the compiled evidence and will serve to provide a fingerprint for that evidence so that any party at any time can confirm the contents of the contemporary version of the evidence. The hash algorithm used to populate this data item must be that specified in the associated D4009 Cryptographic Hash Algorithm.</xs:documentation> </xs:annotation> <xs:simpleType> <xs:restriction base="xs:hexBinary"> <xs:length value="32"/> <xs:whiteSpace value="collapse"/> </xs:restriction> </xs:simpleType> </xs:element></pre>		

element D4009_CryptographicHashAlgorithm

diagram			
namespace	urn:bridgeall-com:cmaservice:data:v3		
type	CryptographicHashAlgorithm		
properties	content simple		
used by	complexType	T034.0_VacSchemeApplication T034.3_VacSchemeApplicationNotification	
facets	Kind enumeration	Value SHA256	annotation
annotation	documentation Name of the cryptographic hash algorithm used to derive the value of an associated D4008 Cryptographic Hash.		
source	<pre><xs:element name="D4009_CryptographicHashAlgorithm" type="CryptographicHashAlgorithm"> <xs:annotation> <xs:documentation>Name of the cryptographic hash algorithm used to derive the value of an associated D4008 Cryptographic Hash.</xs:documentation> </xs:annotation> </xs:element></pre>		

element D4010_VacancyChangeGracePeriod

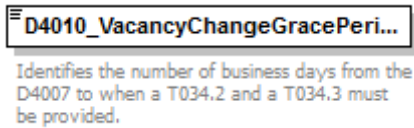
diagram			
---------	---	--	--

namespace	urn:bridgeall-com:cmaservice:data:v3
type	xs:nonNegativeInteger
properties	content simple
used by	complexTypes T034.1_VacSchemeGracePeriodNotification T034.3_VacSchemeApplicationNotification
annotation	documentation Identifies the number of business days from the D4007 to when a T034.2 and a T034.3 must be provided.
source	<pre><xs:element name="D4010_VacancyChangeGracePeriod" type="xs:nonNegativeInteger"> <xs:annotation> <xs:documentation>Identifies the number of business days from the D4007 to when a T034.2 and a T034.3 must be provided.</xs:documentation> </xs:annotation> </xs:element></pre>

element **D4011_WaterSPLPOrgId**

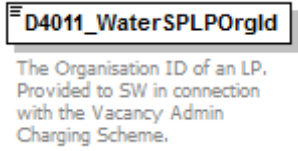
diagram													
namespace	urn:bridgeall-com:cmaservice:data:v3												
type	restriction of xs:string												
properties	content simple												
used by	complexTypes T034.2_VacSchemeGraceEndNotification T034.3_VacSchemeApplicationNotification												
facets	<table border="0"> <tr> <td>Kind</td> <td>Value</td> <td>annotation</td> </tr> <tr> <td>minLength</td> <td>1</td> <td></td> </tr> <tr> <td>maxLength</td> <td>6</td> <td></td> </tr> <tr> <td>pattern</td> <td colspan="2">([a-z][A-Z][0-9][\-\-])*</td> </tr> </table>	Kind	Value	annotation	minLength	1		maxLength	6		pattern	([a-z][A-Z][0-9][\-\-])*	
Kind	Value	annotation											
minLength	1												
maxLength	6												
pattern	([a-z][A-Z][0-9][\-\-])*												
annotation	documentation The Organisation ID of an LP. Provided to SW in connection with the Vacancy Admin Charging Scheme.												
source	<pre><xs:element name="D4011_WaterSPLPOrgId"> <xs:annotation> <xs:documentation>The Organisation ID of an LP. Provided to SW in connection with the Vacancy Admin Charging Scheme.</xs:documentation> </xs:annotation> <xs:simpleType> <xs:restriction base="xs:string"> <xs:minLength value="1"/> <xs:maxLength value="6"/> <xs:pattern value="([a-z][A-Z][0-9][\-\-])*" /> </xs:restriction> </xs:simpleType> </xs:element></pre>												

element D4012_SewerageSPLPorgId

diagram	 <p>The Organisation ID of an LP. Provided to SW in connection with the Vacancy Admin Charging Scheme.</p>												
namespace	urn:bridgeall-com:cmaservice:data:v3												
type	restriction of xs:string												
properties	content simple												
used by	complexTypes T034.2_VacSchemeGraceEndNotification T034.3_VacSchemeApplicationNotification												
facets	<table border="1"> <thead> <tr> <th>Kind</th> <th>Value</th> <th>annotation</th> </tr> </thead> <tbody> <tr> <td>minLength</td> <td>1</td> <td></td> </tr> <tr> <td>maxLength</td> <td>6</td> <td></td> </tr> <tr> <td>pattern</td> <td>([a-z][A-Z][0-9][\-\-])*</td> <td></td> </tr> </tbody> </table>	Kind	Value	annotation	minLength	1		maxLength	6		pattern	([a-z][A-Z][0-9][\-\-])*	
Kind	Value	annotation											
minLength	1												
maxLength	6												
pattern	([a-z][A-Z][0-9][\-\-])*												
annotation	documentation The Organisation ID of an LP. Provided to SW in connection with the Vacancy Admin Charging Scheme.												
source	<pre><xs:element name="D4012_SewerageSPLPorgId"> <xs:annotation> <xs:documentation>The Organisation ID of an LP. Provided to SW in connection with the Vacancy Admin Charging Scheme.</xs:documentation> </xs:annotation> <xs:simpleType> <xs:restriction base="xs:string"> <xs:minLength value="1"/> <xs:maxLength value="6"/> <xs:pattern value="([a-z][A-Z][0-9][\-\-])*" /> </xs:restriction> </xs:simpleType> </xs:element></pre>												

element D5001_FreeDescriptor

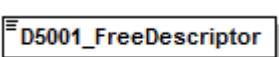
diagram													
namespace	urn:bridgeall-com:cmaservice:data:v3												
type	restriction of xs:string												
properties	content simple												
used by	complexTypes AddressType T004.3_VirtualMeterType												
facets	<table border="1"> <thead> <tr> <th>Kind</th> <th>Value</th> <th>annotation</th> </tr> </thead> <tbody> <tr> <td>maxLength</td> <td>255</td> <td></td> </tr> <tr> <td>whiteSpace</td> <td>preserve</td> <td></td> </tr> <tr> <td>pattern</td> <td>([^\t\n\r])*</td> <td></td> </tr> </tbody> </table>	Kind	Value	annotation	maxLength	255		whiteSpace	preserve		pattern	([^\t\n\r])*	
Kind	Value	annotation											
maxLength	255												
whiteSpace	preserve												
pattern	([^\t\n\r])*												
source	<pre><xs:element name="D5001_FreeDescriptor"> <xs:simpleType> <xs:restriction base="xs:string"> <xs:maxLength value="255"/> <xs:whiteSpace value="preserve"/> <xs:pattern value="([^\t\n\r])*" /> </xs:restriction> </xs:simpleType> </xs:element></pre>												

element D6001_DPID

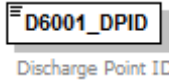
diagram													
namespace	urn:bridgeall-com:cmaservice:data:v3												
type	string32												
properties	content simple												
used by	complexTypes DiscontinueDPIDType DPIDNotificationType DPIDUpdateType DPMeterReadType MeterAssociationType MeterDisAssociationType Schedule3UpdateType TEUpdateType												
facets	<table border="1"> <thead> <tr> <th>Kind</th> <th>Value</th> <th>annotation</th> </tr> </thead> <tbody> <tr> <td>minLength</td> <td>1</td> <td></td> </tr> <tr> <td>maxLength</td> <td>32</td> <td></td> </tr> <tr> <td>pattern</td> <td>([\^, \t\n\rj]*)</td> <td></td> </tr> </tbody> </table>	Kind	Value	annotation	minLength	1		maxLength	32		pattern	([\^, \t\n\rj]*)	
Kind	Value	annotation											
minLength	1												
maxLength	32												
pattern	([\^, \t\n\rj]*)												
annotation	documentation Discharge Point ID												
source	<pre><xs:element name="D6001_DPID" type="string32"> <xs:annotation> <xs:documentation>Discharge Point ID</xs:documentation> </xs:annotation> </xs:element></pre>												

element D6002_TeYVe

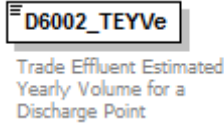
diagram																
namespace	urn:bridgeall-com:cmaservice:data:v3															
type	decimal18															
properties	content simple															
used by	complexTypes DPIDNotificationType DPIDUpdateType															
facets	<table border="1"> <thead> <tr> <th>Kind</th> <th>Value</th> <th>annotation</th> </tr> </thead> <tbody> <tr> <td>minInclusive</td> <td>0</td> <td></td> </tr> <tr> <td>maxInclusive</td> <td>9999999999</td> <td></td> </tr> <tr> <td>totalDigits</td> <td>18</td> <td></td> </tr> <tr> <td>fractionDigits</td> <td>8</td> <td></td> </tr> </tbody> </table>	Kind	Value	annotation	minInclusive	0		maxInclusive	9999999999		totalDigits	18		fractionDigits	8	
Kind	Value	annotation														
minInclusive	0															
maxInclusive	9999999999															
totalDigits	18															
fractionDigits	8															
annotation	documentation Trade Effluent Estimated Yearly Volume for a Discharge Point															
source	<pre><xs:element name="D6002_TeYVe" type="decimal18"> <xs:annotation> <xs:documentation>Trade Effluent Estimated Yearly Volume for a Discharge Point</xs:documentation> </xs:annotation> </xs:element></pre>															

element **D6003_CDV**

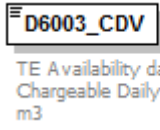
diagram																
namespace	urn:bridgeall-com:cmaservice:data:v3															
type	decimal18															
properties	content simple															
used by	complexTypees DPIDNotificationType DPIDUpdateType															
facets	<table border="1"> <thead> <tr> <th>Kind</th> <th>Value</th> <th>annotation</th> </tr> </thead> <tbody> <tr> <td>minInclusive</td> <td>0</td> <td></td> </tr> <tr> <td>maxInclusive</td> <td>9999999999</td> <td></td> </tr> <tr> <td>totalDigits</td> <td>18</td> <td></td> </tr> <tr> <td>fractionDigits</td> <td>8</td> <td></td> </tr> </tbody> </table>	Kind	Value	annotation	minInclusive	0		maxInclusive	9999999999		totalDigits	18		fractionDigits	8	
Kind	Value	annotation														
minInclusive	0															
maxInclusive	9999999999															
totalDigits	18															
fractionDigits	8															
annotation	documentation TE Availability data: Chargeable Daily Volume m3															
source	<pre><xs:element name="D6003_CDV" type="decimal18"> <xs:annotation> <xs:documentation>TE Availability data: Chargeable Daily Volume m3</xs:documentation> </xs:annotation> </xs:element></pre>															

element **D6004_sBODL**

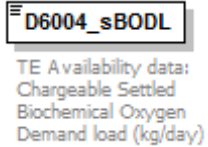
diagram																
namespace	urn:bridgeall-com:cmaservice:data:v3															
type	decimal18															
properties	content simple															
used by	complexTypees DPIDNotificationType DPIDUpdateType															
facets	<table border="1"> <thead> <tr> <th>Kind</th> <th>Value</th> <th>annotation</th> </tr> </thead> <tbody> <tr> <td>minInclusive</td> <td>0</td> <td></td> </tr> <tr> <td>maxInclusive</td> <td>9999999999</td> <td></td> </tr> <tr> <td>totalDigits</td> <td>18</td> <td></td> </tr> <tr> <td>fractionDigits</td> <td>8</td> <td></td> </tr> </tbody> </table>	Kind	Value	annotation	minInclusive	0		maxInclusive	9999999999		totalDigits	18		fractionDigits	8	
Kind	Value	annotation														
minInclusive	0															
maxInclusive	9999999999															
totalDigits	18															
fractionDigits	8															
annotation	documentation TE Availability data: Chargeable Settled Biochemical Oxygen Demand load (kg/day)															
source	<pre><xs:element name="D6004_sBODL" type="decimal18"> <xs:annotation> <xs:documentation>TE Availability data: Chargeable Settled Biochemical Oxygen Demand load (kg/day)</xs:documentation> </xs:annotation> </xs:element></pre>															

element **D6005_TSSL**

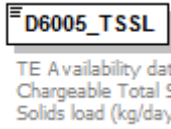
diagram	 <p>TE Availability data: Chargeable Total Suspended Solids load (kg/day)</p>															
namespace	urn:bridgeall-com:cmaservice:data:v3															
type	decimal18															
properties	content simple															
used by	complexTypees DPIDNotificationType DPIDUpdateType															
facets	<table border="1"> <thead> <tr> <th>Kind</th> <th>Value</th> <th>annotation</th> </tr> </thead> <tbody> <tr> <td>minInclusive</td> <td>0</td> <td></td> </tr> <tr> <td>maxInclusive</td> <td>9999999999</td> <td></td> </tr> <tr> <td>totalDigits</td> <td>18</td> <td></td> </tr> <tr> <td>fractionDigits</td> <td>8</td> <td></td> </tr> </tbody> </table>	Kind	Value	annotation	minInclusive	0		maxInclusive	9999999999		totalDigits	18		fractionDigits	8	
Kind	Value	annotation														
minInclusive	0															
maxInclusive	9999999999															
totalDigits	18															
fractionDigits	8															
annotation	documentation TE Availability data: Chargeable Total Suspended Solids load (kg/day)															
source	<pre><xs:element name="D6005_TSSL" type="decimal18"> <xs:annotation> <xs:documentation>TE Availability data: Chargeable Total Suspended Solids load (kg/day)</xs:documentation> </xs:annotation> </xs:element></pre>															

element **D6006_Ot**

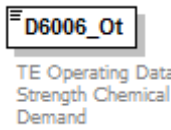
diagram	 <p>TE Operating Data: Fixed Strength Chemical Oxygen Demand</p>															
namespace	urn:bridgeall-com:cmaservice:data:v3															
type	decimal18															
properties	content simple															
used by	complexTypees DPIDNotificationType TEUpdateType															
facets	<table border="1"> <thead> <tr> <th>Kind</th> <th>Value</th> <th>annotation</th> </tr> </thead> <tbody> <tr> <td>minInclusive</td> <td>0</td> <td></td> </tr> <tr> <td>maxInclusive</td> <td>9999999999</td> <td></td> </tr> <tr> <td>totalDigits</td> <td>18</td> <td></td> </tr> <tr> <td>fractionDigits</td> <td>8</td> <td></td> </tr> </tbody> </table>	Kind	Value	annotation	minInclusive	0		maxInclusive	9999999999		totalDigits	18		fractionDigits	8	
Kind	Value	annotation														
minInclusive	0															
maxInclusive	9999999999															
totalDigits	18															
fractionDigits	8															
annotation	documentation TE Operating Data: Fixed Strength Chemical Oxygen Demand															
source	<pre><xs:element name="D6006_Ot" type="decimal18"> <xs:annotation> <xs:documentation>TE Operating Data: Fixed Strength Chemical Oxygen Demand</xs:documentation> </xs:annotation> </xs:element></pre>															

element **D6007_St**

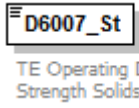
diagram	 <p>TE Operating Data: Fixed Strength Solids Demand</p>															
namespace	urn:bridgeall-com:cmaservice:data:v3															
type	decimal18															
properties	content simple															
used by	complexTypees DPIDNotificationType TEUpdateType															
facets	<table border="1"> <thead> <tr> <th>Kind</th> <th>Value</th> <th>annotation</th> </tr> </thead> <tbody> <tr> <td>minInclusive</td> <td>0</td> <td></td> </tr> <tr> <td>maxInclusive</td> <td>9999999999</td> <td></td> </tr> <tr> <td>totalDigits</td> <td>18</td> <td></td> </tr> <tr> <td>fractionDigits</td> <td>8</td> <td></td> </tr> </tbody> </table>	Kind	Value	annotation	minInclusive	0		maxInclusive	9999999999		totalDigits	18		fractionDigits	8	
Kind	Value	annotation														
minInclusive	0															
maxInclusive	9999999999															
totalDigits	18															
fractionDigits	8															
annotation	documentation TE Operating Data: Fixed Strength Solids Demand															
source	<pre><xs:element name="D6007_St" type="decimal18"> <xs:annotation> <xs:documentation>TE Operating Data: Fixed Strength Solids Demand</xs:documentation> </xs:annotation> </xs:element></pre>															

element **D6009_Non-domesticAllowance**

diagram	 <p>Annual volume associated with the foul sewerage for the Discharge Point (m3)</p>									
namespace	urn:bridgeall-com:cmaservice:data:v3									
type	restriction of xs:integer									
properties	content simple									
used by	complexTypees DPIDNotificationType DPIDUpdateType									
facets	<table border="1"> <thead> <tr> <th>Kind</th> <th>Value</th> <th>annotation</th> </tr> </thead> <tbody> <tr> <td>minInclusive</td> <td>0</td> <td></td> </tr> <tr> <td>maxInclusive</td> <td>9999999999</td> <td></td> </tr> </tbody> </table>	Kind	Value	annotation	minInclusive	0		maxInclusive	9999999999	
Kind	Value	annotation								
minInclusive	0									
maxInclusive	9999999999									
annotation	documentation Annual volume associated with the foul sewerage for the Discharge Point (m3)									
source	<pre><xs:element name="D6009_Non-domesticAllowance"> <xs:annotation> <xs:documentation>Annual volume associated with the foul sewerage for the Discharge Point (m3)</xs:documentation> </xs:annotation> <xs:simpleType> <xs:restriction base="xs:integer"> <xs:minInclusive value="0"/> <xs:maxInclusive value="9999999999"/> </xs:restriction> </xs:simpleType> </xs:element></pre>									

element D6010_SDTIndicator

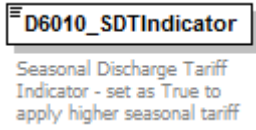
diagram	
namespace	urn:bridgeall-com:cmaservice:data:v3
type	xs:boolean
properties	content simple
used by	complexTypees DPIDNotificationType DPIDUpdateType
annotation	documentation Seasonal Discharge Tariff Indicator - set as True to apply higher seasonal tariff
source	<pre><xs:element name="D6010_SDTIndicator" type="xs:boolean"> <xs:annotation> <xs:documentation>Seasonal Discharge Tariff Indicator - set as True to apply higher seasonal tariff</xs:documentation> </xs:annotation> </xs:element></pre>

element D6011_TETreatment

diagram													
namespace	urn:bridgeall-com:cmaservice:data:v3												
type	TETreatmentType												
properties	content simple												
used by	complexType DPIDNotificationType												
facets	<table border="0"> <tr> <td>Kind</td> <td>Value</td> <td>annotation</td> </tr> <tr> <td>enumeration</td> <td>Secondary</td> <td></td> </tr> <tr> <td>enumeration</td> <td>Primary</td> <td></td> </tr> <tr> <td>enumeration</td> <td>Sub-Primary</td> <td></td> </tr> </table>	Kind	Value	annotation	enumeration	Secondary		enumeration	Primary		enumeration	Sub-Primary	
Kind	Value	annotation											
enumeration	Secondary												
enumeration	Primary												
enumeration	Sub-Primary												
annotation	documentation TETreatment indicator												
source	<pre><xs:element name="D6011_TETreatment" type="TETreatmentType"> <xs:annotation> <xs:documentation>TETreatment indicator</xs:documentation> </xs:annotation> </xs:element></pre>												

element D6012_PcentAllowance

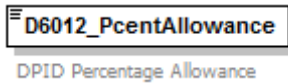
diagram	
namespace	urn:bridgeall-com:cmaservice:data:v3
type	percentage
properties	content simple
used by	complexTypees DPIDNotificationType DPIDUpdateType

facets	Kind	Value	annotation
	minInclusive	0	
	maxInclusive	100	
	totalDigits	5	
	fractionDigits	2	
annotation	documentation DPID Percentage Allowance		
source	<pre><xs:element name="D6012_PcentAllowance" type="percentage"> <xs:annotation> <xs:documentation>DPID Percentage Allowance</xs:documentation> </xs:annotation> </xs:element></pre>		

element **D6013_FixedAllowance**

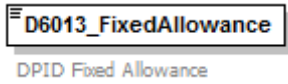
diagram	
namespace	urn:bridgeall-com:cmaservice:data:v3
type	xs:nonNegativeInteger
properties	content simple
used by	complexTypees DPIDNotificationType DPIDUpdateType
annotation	documentation DPID Fixed Allowance
source	<pre><xs:element name="D6013_FixedAllowance" type="xs:nonNegativeInteger"> <xs:annotation> <xs:documentation>DPID Fixed Allowance</xs:documentation> </xs:annotation> </xs:element></pre>

element **Document**

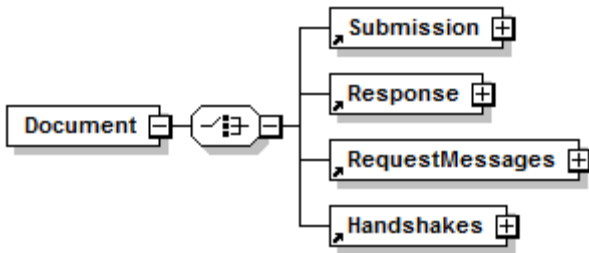
diagram	
namespace	urn:bridgeall-com:cmaservice:data:v3
properties	content complex
children	Submission Response RequestMessages Handshakes
source	<pre><xs:element name="Document"> <xs:complexType> <xs:choice> <xs:element ref="Submission"/> <xs:element ref="Response"/> <xs:element ref="RequestMessages"/> <xs:element ref="Handshakes"/> </xs:choice> </xs:complexType> </xs:element></pre>

	<pre></xs:complexType> </xs:element></pre>
--	--

element Handshakes

diagram													
namespace	urn:bridgeall-com:cmaservice:data:v3												
properties	content complex												
children	HandShake												
used by	element Document												
attributes	<table border="1"> <thead> <tr> <th>Name</th> <th>Type</th> <th>Use</th> <th>Default</th> <th>Fixed</th> <th>annotation</th> </tr> </thead> <tbody> <tr> <td>D1005_SenderOrgID</td> <td></td> <td>required</td> <td></td> <td></td> <td></td> </tr> </tbody> </table>	Name	Type	Use	Default	Fixed	annotation	D1005_SenderOrgID		required			
Name	Type	Use	Default	Fixed	annotation								
D1005_SenderOrgID		required											
source	<pre><xs:element name="Handshakes"> <xs:complexType> <xs:sequence maxOccurs="unbounded"> <xs:element name="HandShake"> <xs:complexType> <xs:attribute name="D1003_FlowReference" type="xs:string" use="required"/> <xs:attribute name="MessageCount" type="xs:int" use="optional"/> <xs:attribute name="XMLDocLength" type="xs:int" use="optional"/> </xs:complexType> </xs:element> </xs:sequence> <xs:attribute name="D1005_SenderOrgID" use="required"/> </xs:complexType> </xs:element></pre>												

attribute Handshakes/@D1005_SenderOrgID

properties	isRef 0 use required
source	<pre><xs:attribute name="D1005_SenderOrgID" use="required"/></pre>

element Handshakes/HandShake

diagram	
namespace	urn:bridgeall-com:cmaservice:data:v3

properties	isRef 0 content complex					
attributes	Name D1003_FlowReference MessageCount XMLDocLength	Type xs:string xs:int xs:int	Use required optional optional	Default	Fixed	annotation
source	<pre><xs:element name="HandShake"> <xs:complexType> <xs:attribute name="D1003_FlowReference" type="xs:string" use="required"/> <xs:attribute name="MessageCount" type="xs:int" use="optional"/> <xs:attribute name="XMLDocLength" type="xs:int" use="optional"/> </xs:complexType> </xs:element></pre>					

attribute Handshakes/HandShake/@D1003_FlowReference

type	xs:string
properties	isRef 0 use required
source	<pre><xs:attribute name="D1003_FlowReference" type="xs:string" use="required"/></pre>

attribute Handshakes/HandShake/@MessageCount

type	xs:int
properties	isRef 0 use optional
source	<pre><xs:attribute name="MessageCount" type="xs:int" use="optional"/></pre>

attribute Handshakes/HandShake/@XMLDocLength

type	xs:int
properties	isRef 0 use optional
source	<pre><xs:attribute name="XMLDocLength" type="xs:int" use="optional"/></pre>

element Messages

<p>diagram</p>	<p>The diagram shows a vertical list of message types enclosed in a dashed box labeled 'MessagesType'. Each message type is represented by a small box with a plus sign icon. The message types listed are:</p> <ul style="list-style-type: none"> T001.0_NewSPIDRequests T003.0_PartialRegistrationAppli... T003.1_RegistrationApplications T004.0_NewMeters T004.2_LPMeterUpdates T004.3_VirtualMeters T005.0_SWMeterReads T005.1_LPMeterReads T006.0_LPWATERSPIDUpdates T006.1_LPSewerageSPIDUpdates T006.2_WaterSPIDUpdates T006.3_SewerageSPIDUpdates T007.0_WaterConnectionCompl... T007.1_SewerageConnectionC... T009.2_Notifications T009.3_Notifications T010.0_CancelRegistrations T010.1_CancelRegistrations T012.0_MiscSPIDUpdates T012.1_ServiceElementUpdates T012.3_SewerageServiceEleme... T012.5_UpdateSAAReferenceNu... T013.0_MeterUpdates T013.2_UpdateMeterLocations T014.0_ChargeableMeterUpdates T015.0_DisconnectionDeclaratio... T016.0_UnmeasurableDeclarat... T017.0_MeterSwaps T021.0_NewDPIDs T022.0_TEUpdates T023.0_MeterAssociations T024.0_MeterDisAssociations T026.0_DiscontinueDPIDs T027.0_DPIDUpdates T028.1_Schedule3Updates T029.1_SpecialArrangementsU... T029.3_Premises SpecialArrang... T032.0_CreateUpdateCustomer... T033.0_MeteredBuildings T034.0_VacSchemeApplications T034.4_VacSchemeApplication... T036.0_MeterNetworkAssociati... <p>Below the list is a 'constraints' section containing a 'unique' constraint:</p> <ul style="list-style-type: none"> unique UniqueMessageID <ul style="list-style-type: none"> selector * field @MID
<p>namespace</p>	<p>urn:bridgeall-com:cmaservice:data:v3</p>
<p>type</p>	<p>MessagesType</p>

properties	content complex								
children	T001.0 NewSPIDRequests T003.0 PartialRegistrationApplications T003.1 RegistrationApplications T004.0 NewMeters T004.2 LPMeterUpdates T004.3 VirtualMeters T005.0 SWMeterReads T005.1 LPMeterReads T006.0 LPWaterSPIDUpdates T006.1 LPsewageSPIDUpdates T006.2 WaterSPIDUpdates T006.3 SewerageSPIDUpdates T007.0 WaterConnectionCompletes T007.1 SewerageConnectionCompletes T009.2 Notifications T010.0 CancelRegistrations T010.1 CancelRegistrations T012.0 MiscSPIDUpdates T012.1 ServiceElementUpdates T012.3 SewerageServiceElementUpdates T012.5 UpdateSAAReferenceNumberUPRNs T013.0 MeterUpdates T013.2 UpdateMeterLocations T014.0 ChargeableMeterUpdates T015.0 DisconnectionDeclarations T016.0 UnmeasureableDeclarations T017.0 MeterSwaps T021.0 NewDPIDs T022.0 TEUpdates T023.0 MeterAssociations T024.0 MeterDisAssociations T026.0 DiscontinueDPIDs T027.0 DPIDUpdates T028.1 Schedule3Updates T029.1 SpecialArrangementsUpdates T029.3 PremisesSpecialArrangementsUpdates T032.0 CreateUpdateCustomerName T033.0 MeteredBuildings T034.0 VacSchemeApplications T034.4 VacSchemeApplicationConfirmationOrCancellations T036.0 MeterNetworkAssociations								
used by	element Submission								
identity constraints	<table border="1"> <thead> <tr> <th>Name</th> <th>Refer</th> <th>Selector</th> <th>Field(s)</th> </tr> </thead> <tbody> <tr> <td>unique</td> <td>UniqueMessageID</td> <td>*/*</td> <td>@MID</td> </tr> </tbody> </table>	Name	Refer	Selector	Field(s)	unique	UniqueMessageID	*/*	@MID
Name	Refer	Selector	Field(s)						
unique	UniqueMessageID	*/*	@MID						
source	<pre><xs:element name="Messages" type="MessagesType"> <xs:unique name="UniqueMessageID"> <xs:selector xpath="*/*" /> <xs:field xpath="@MID" /> </xs:unique> </xs:element></pre>								

element RequestMessages

diagram													
namespace	urn:bridgeall-com:cmaservice:data:v3												
properties	content complex												
children	NewMessages												
used by	element Document												
attributes	<table border="1"> <thead> <tr> <th>Name</th> <th>Type</th> <th>Use</th> <th>Default</th> <th>Fixed</th> <th>annotation</th> </tr> </thead> <tbody> <tr> <td>D1005_SenderOrgID</td> <td></td> <td>required</td> <td></td> <td></td> <td></td> </tr> </tbody> </table>	Name	Type	Use	Default	Fixed	annotation	D1005_SenderOrgID		required			
Name	Type	Use	Default	Fixed	annotation								
D1005_SenderOrgID		required											
source	<pre><xs:element name="RequestMessages"> <xs:complexType> <xs:choice> <xs:element name="NewMessages"> <xs:complexType> <xs:attribute name="MaxMessages" type="xs:short" use="required" /> </xs:complexType> </xs:element> </xs:choice> <xs:attribute name="D1005_SenderOrgID" use="required" /> </xs:complexType> </xs:element></pre>												

attribute **RequestMessages/@D1005_SenderOrgID**

properties	isRef 0 use required
source	<xs:attribute name="D1005_SenderOrgID" use="required"/>

element **RequestMessages/NewMessages**

diagram	<p>The diagram shows a box labeled 'NewMessages' with a small square icon on its left side. A line connects this icon to a larger box labeled 'MaxMessages'. Above the 'MaxMessages' box is a smaller box labeled 'attributes' with a minus sign icon, indicating that 'MaxMessages' is an attribute of 'NewMessages'.</p>					
namespace	urn:bridgeall-com:cmaservice:data:v3					
properties	isRef 0 content complex					
attributes	Name	Type	Use	Default	Fixed	annotation
	MaxMessages	xs:short	required			
source	<pre><xs:element name="NewMessages"> <xs:complexType> <xs:attribute name="MaxMessages" type="xs:short" use="required"/> </xs:complexType> </xs:element></pre>					

attribute **RequestMessages/NewMessages/@MaxMessages**

type	xs:short
properties	isRef 0 use required
source	<xs:attribute name="MaxMessages" type="xs:short" use="required"/>

element **Response**

diagram	<p>The diagram shows a box labeled 'Response' with a small square icon on its left side. A line connects this icon to a circle containing three dots. From the right side of the circle, two lines branch out to two boxes: 'ResponseHeader' and 'ResponseMessages'. Both boxes have a plus sign icon on their right side, indicating they are children of the 'Response' element. The 'ResponseMessages' box is shown with a dashed border, suggesting it is optional or has a default value of 0.</p>					
namespace	urn:bridgeall-com:cmaservice:data:v3					
properties	content complex					
children	ResponseHeader ResponseMessages					
used by	element	Document				
source	<pre><xs:element name="Response"> <xs:complexType> <xs:sequence> <xs:element name="ResponseHeader" type="TransactionHeaderType"/> <xs:element ref="ResponseMessages" minOccurs="0"/> </xs:sequence> </xs:complexType> </xs:element></pre>					

element **Response/ResponseHeader**

<p>diagram</p>	<p>The diagram illustrates the structure of the ResponseHeader element. It contains a TransactionHeaderType complex type, which includes four child elements:</p> <ul style="list-style-type: none"> D1005_SenderOrgId: D1005 Organisation ID of organisation sending data D1006_RecipientOrgId: D1006 Organisation ID of intended recipient of data D1007_TransactionTimestamp: D1007 Timestamp of data flow on send D1003_FlowReference: D1003 Provides a reference ID for flow from originating org
<p>namespace</p>	<p>urn:bridgeall-com:cmaservice:data:v3</p>
<p>type</p>	<p>TransactionHeaderType</p>
<p>properties</p>	<p>isRef 0 content complex</p>
<p>children</p>	<p>D1005_SenderOrgId D1006_RecipientOrgId D1007_TransactionTimestamp D1003_FlowReference</p>
<p>source</p>	<p><code><xs:element name="ResponseHeader" type="TransactionHeaderType"/></code></p>

element **ResponseMessages**

<p>diagram</p>	<p>ResponseMessagesType</p> <ul style="list-style-type: none"> T002.0_NewSPIDNotification T002.1_NewSPIDNotification T004.1_NewMeterNotificati... T005.2_MeterReadNotificat... T005.3_MeterReadNotificat... T006.4_WaterSPIDNotificat... T006.5_SewerageSPIDNotif... T007.2_ConnectionComple... T008.0_TerminationNotifica... T008.1_RegistrationConfir... T008.2_NotifyRSD T009.0_Notification T009.1_Notification T009.4_Notification T011.0_CancelRegistration... T011.1_CancelRegistration... T012.2_ServiceElementUp... T012.4_SewerageServiceEL... T012.6_UpdateSAAREferen... T013.1_MeterUpdate T013.3_UpdateMeterLocati... T014.1_MeterUpdateNotific... T015.1_DisconnectionNotifi... T016.1_UnmeasurableNot... T017.1_MeterSwapNotifica... T019.0_WaterSPIDData T020.0_SewerageSPIDData T021.1_DPIDNotification T022.1_TEUpdateNotification T023.1_MeterAssociationN... T024.1_MeterDisAssociati... T026.1_DiscontinueDPIDNo... T027.1_DPIDUpdateNotificat... T028.0_Schedule3UpdateN... T029.0_SpecialArrangeme... T029.4_PremisesSpecialAr... T030.0_DPMeterReadNotifi... T030.1_DPMeterReadNotifi... T032.1_CustomerNameUp... T032.2_CustomerNameUp... T033.1_MeteredBuildingUp... T034.1_VacSchemeGraceP... T034.2_VacSchemeGraceE... T034.3_VacSchemeApplica... T034.5_VacSchemeApplica... T035.0_TradeabilityNotifica... T035.1_TradeabilityNotifica... T036.1_MeterNetworkAss... <p>ResponseMessages 1..2</p> <p>constraints</p> <ul style="list-style-type: none"> unique UniqueResponseMess... <ul style="list-style-type: none"> selector * field @MD
<p>namespace</p>	<p>urn:bridgeall-com:cmaservice:data:v3</p>
<p>type</p>	<p>ResponseMessagesType</p>

properties	content complex								
children	T002.0 NewSPIDNotification T002.1 NewSPIDNotification T004.1 NewMeterNotification T005.2 MeterReadNotification T005.3 MeterReadNotification T006.4 WaterSPIDNotification T006.5 SewerageSPIDNotification T007.2 ConnectionCompleteNotification T008.0 TerminationNotification T008.1 RegistrationConfirmation T008.2 NotifyRSD T009.0 Notification T009.1 Notification T009.4 Notification T011.0 CancelRegistrationNotification T011.1 CancelRegistrationNotification T012.2 ServiceElementUpdateNotification T012.4 SewerageServiceElementUpdateNotification T012.6 UpdateSAARefrenceNumberUPRNNotification T013.1 MeterUpdate T013.3 UpdateMeterLocationNotification T014.1 MeterUpdateNotification T015.1 DisconnectionNotification T016.1 UnmeasureableNotification T017.1 MeterSwapNotification T019.0 WaterSPIDData T020.0 SewerageSPIDData T021.1 DPIDNotification T022.1 TEUpdateNotification T023.1 MeterAssociationNotification T024.1 MeterDisAssociationNotification T026.1 DiscontinueDPIDNotification T027.1 DPIDUpdateNotification T028.0 Schedule3UpdateNotification T029.0 SpecialArrangementsUpdateNotification T029.4 PremisesSpecialArrangementsUpdateNotification T030.0 DPMeterReadNotification T030.1 DPMeterReadNotification T032.1 CustomerNameUpdated T032.2 CustomerNameUpdatedNotification T033.1 MeteredBuildingUpdate T034.1 VacSchemeGracePeriodNotification T034.2 VacSchemeGraceEndNotification T034.3 VacSchemeApplicationNotification T034.5 VacSchemeApplicationConfirmationOrCancellationNotification T035.0 TradeabilityNotification T035.1 TradeabilityNotification T036.1 MeterNetworkAssociationNotification								
used by	element Response								
identity constraints	<table border="1"> <thead> <tr> <th>Name</th> <th>Refer</th> <th>Selector</th> <th>Field(s)</th> </tr> </thead> <tbody> <tr> <td>unique</td> <td>UniqueResponseMessageID</td> <td>*</td> <td>@MID</td> </tr> </tbody> </table>	Name	Refer	Selector	Field(s)	unique	UniqueResponseMessageID	*	@MID
Name	Refer	Selector	Field(s)						
unique	UniqueResponseMessageID	*	@MID						
source	<pre><xs:element name="ResponseMessages" type="ResponseMessagesType"> <xs:unique name="UniqueResponseMessageID"> <xs:selector xpath="*/"> <xs:field xpath="@MID"/> </xs:unique> </xs:element></pre>								

element **Submission**

diagram	<pre> classDiagram class Submission { Header Messages } class Header class Messages Submission "1" -- "*" Header Submission "1" -- "*" Messages </pre>
namespace	urn:bridgeall-com:cmaservice:data:v3
properties	content complex
children	Header Messages
used by	element Document
source	<pre><xs:element name="Submission"> <xs:complexType> <xs:sequence> <xs:element name="Header" type="TransactionHeaderType"/> <xs:element ref="Messages"/> </xs:sequence> </xs:complexType> </xs:element></pre>

element **Submission/Header**

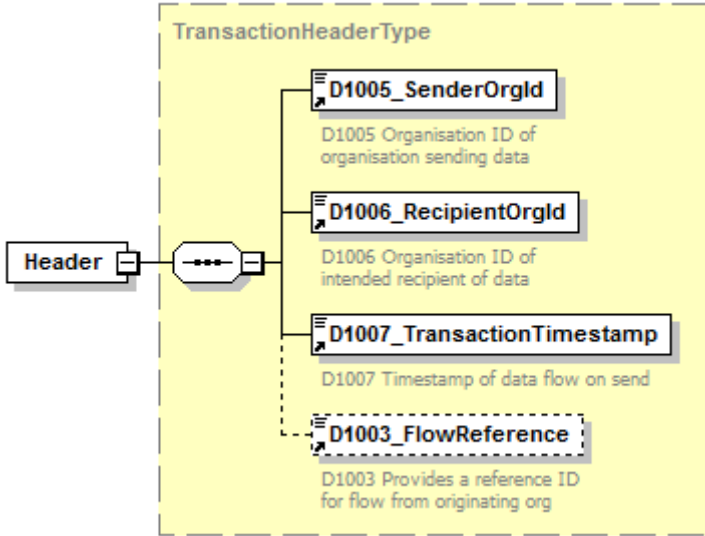
<p>diagram</p>	 <p>The diagram illustrates the structure of the TransactionHeaderType element. A central box labeled Header is connected to a dashed-line box labeled TransactionHeaderType. Inside this dashed box, four data elements are listed: D1005_SenderOrgId (D1005 Organisation ID of organisation sending data), D1006_RecipientOrgId (D1006 Organisation ID of intended recipient of data), D1007_TransactionTimestamp (D1007 Timestamp of data flow on send), and D1003_FlowReference (D1003 Provides a reference ID for flow from originating org). The D1003_FlowReference element is shown with a dashed border, indicating it is optional.</p>
<p>namespace</p>	<p>urn:bridgeall-com:cmaservice:data:v3</p>
<p>type</p>	<p>TransactionHeaderType</p>
<p>properties</p>	<p>isRef 0 content complex</p>
<p>children</p>	<p>D1005_SenderOrgId D1006_RecipientOrgId D1007_TransactionTimestamp D1003_FlowReference</p>
<p>source</p>	<p><code><xs:element name="Header" type="TransactionHeaderType"/></code></p>

complexType **AddressType**

<p>diagram</p>	
<p>namespace</p>	<p>urn:bridgeall-com:cmaservice:data:v3</p>
<p>children</p>	<p>D5001_FreeDescriptor D5002_SubBuildingName D5003_BuildingName D5004_BuildingNumber D5005_DependentThoroughfareName D5006_DependentThoroughfareDescriptor D5007_ThoroughfareName D5008_ThoroughfareDescriptor D5009_DoubleDependentLocality D5010_DependentLocality D5011_PostTown D5012_County D5013_Postcode</p>
<p>used by</p>	<p>elements NewSPIDNotificationType/Address NewLPSPIDNotificationType/Address T012.0_MiscSPIDUpdateType/Address WaterSPIDDataType/Address SewerageSPIDDataType/Address DPIDNotificationType/Address DPIDUpdateType/Address T004.0_NewMeterType/MeterLocation T004.1_NewMeterNotificationType/MeterLocation MeterUpdateType/MeterLocation MeterUpdateNotificationType/MeterLocation NewSPIDRequestType/SPIDLocation</p>
<p>source</p>	<pre><xs:complexType name="AddressType"> <xs:sequence> <xs:element ref="D5001_FreeDescriptor" minOccurs="0"/> <xs:element name="D5002_SubBuildingName" minOccurs="0"> <xs:simpleType> <xs:restriction base="xs:string"> <xs:maxLength value="30"/> <xs:whiteSpace value="preserve"/> <xs:pattern value="([^\t\n\r])*"/> </xs:restriction> </xs:simpleType> </xs:element> <xs:element name="D5003_BuildingName" minOccurs="0"> <xs:simpleType> <xs:restriction base="xs:string"> <xs:maxLength value="50"/> <xs:whiteSpace value="preserve"/> <xs:pattern value="([^\t\n\r])*"/> </xs:restriction> </xs:simpleType> </xs:element> </xs:sequence> </xs:complexType></pre>

```

</xs:restriction>
</xs:simpleType>
</xs:element>
<xs:element name="D5004_BuildingNumber" minOccurs="0">
  <xs:simpleType>
    <xs:restriction base="xs:string">
      <xs:maxLength value="4"/>
      <xs:pattern value="([^\t\n\r])*"/>
    </xs:restriction>
  </xs:simpleType>
</xs:element>
<xs:element name="D5005_DependentThoroughfareName" minOccurs="0">
  <xs:simpleType>
    <xs:restriction base="xs:string">
      <xs:maxLength value="60"/>
      <xs:pattern value="([^\t\n\r])*"/>
    </xs:restriction>
  </xs:simpleType>
</xs:element>
<xs:element name="D5006_DependentThoroughfareDescriptor"
minOccurs="0">
  <xs:simpleType>
    <xs:restriction base="xs:string">
      <xs:maxLength value="20"/>
      <xs:pattern value="([^\t\n\r])*"/>
    </xs:restriction>
  </xs:simpleType>
</xs:element>
<xs:element name="D5007_ThoroughfareName" minOccurs="0">
  <xs:simpleType>
    <xs:restriction base="xs:string">
      <xs:maxLength value="60"/>
      <xs:pattern value="([^\t\n\r])*"/>
    </xs:restriction>
  </xs:simpleType>
</xs:element>
<xs:element name="D5008_ThoroughfareDescriptor" minOccurs="0">
  <xs:simpleType>
    <xs:restriction base="xs:string">
      <xs:maxLength value="20"/>
      <xs:pattern value="([^\t\n\r])*"/>
    </xs:restriction>
  </xs:simpleType>
</xs:element>
<xs:element name="D5009_DoubleDependentLocality" minOccurs="0">
  <xs:simpleType>
    <xs:restriction base="xs:string">
      <xs:maxLength value="35"/>
      <xs:pattern value="([^\t\n\r])*"/>
    </xs:restriction>
  </xs:simpleType>
</xs:element>
<xs:element name="D5010_DependentLocality" minOccurs="0">
  <xs:simpleType>
    <xs:restriction base="xs:string">
      <xs:maxLength value="35"/>
      <xs:pattern value="([^\t\n\r])*"/>
    </xs:restriction>
  </xs:simpleType>

```

	<pre> </xs:element> <xs:element name="D5011_PostTown" minOccurs="0"> <xs:simpleType> <xs:restriction base="xs:string"> <xs:maxLength value="30"/> <xs:pattern value="([^\t\n\r])*"/> </xs:restriction> </xs:simpleType> </xs:element> <xs:element name="D5012_County" minOccurs="0"> <xs:simpleType> <xs:restriction base="xs:string"> <xs:maxLength value="30"/> <xs:pattern value="([^\t\n\r])*"/> </xs:restriction> </xs:simpleType> </xs:element> <xs:element name="D5013_Postcode" type="PostcodeType" minOccurs="0"/> </xs:sequence> </xs:complexType> </pre>
--	---

element **AddressType/D5002_SubBuildingName**

diagram													
namespace	urn:bridgeall-com:cmaservice:data:v3												
type	restriction of xs:string												
properties	<table> <tr><td>isRef</td><td>0</td></tr> <tr><td>minOcc</td><td>0</td></tr> <tr><td>maxOcc</td><td>1</td></tr> <tr><td>content</td><td>simple</td></tr> </table>	isRef	0	minOcc	0	maxOcc	1	content	simple				
isRef	0												
minOcc	0												
maxOcc	1												
content	simple												
facets	<table> <tr><td>Kind</td><td>Value</td><td>annotation</td></tr> <tr><td>maxLength</td><td>30</td><td></td></tr> <tr><td>whiteSpace</td><td>preserve</td><td></td></tr> <tr><td>pattern</td><td>([^\t\n\r)*</td><td></td></tr> </table>	Kind	Value	annotation	maxLength	30		whiteSpace	preserve		pattern	([^\t\n\r)*	
Kind	Value	annotation											
maxLength	30												
whiteSpace	preserve												
pattern	([^\t\n\r)*												
source	<pre> <xs:element name="D5002_SubBuildingName" minOccurs="0"> <xs:simpleType> <xs:restriction base="xs:string"> <xs:maxLength value="30"/> <xs:whiteSpace value="preserve"/> <xs:pattern value="([^\t\n\r])*"/> </xs:restriction> </xs:simpleType> </xs:element> </pre>												

element **AddressType/D5003_BuildingName**

diagram									
namespace	urn:bridgeall-com:cmaservice:data:v3								
type	restriction of xs:string								
properties	<table> <tr><td>isRef</td><td>0</td></tr> <tr><td>minOcc</td><td>0</td></tr> <tr><td>maxOcc</td><td>1</td></tr> <tr><td>content</td><td>simple</td></tr> </table>	isRef	0	minOcc	0	maxOcc	1	content	simple
isRef	0								
minOcc	0								
maxOcc	1								
content	simple								

facets	Kind	Value	annotation
	maxLength	50	
	whiteSpace	preserve	
	pattern	([^\t\n\r])*	
source	<pre><xs:element name="D5003_BuildingName" minOccurs="0"> <xs:simpleType> <xs:restriction base="xs:string"> <xs:maxLength value="50"/> <xs:whiteSpace value="preserve"/> <xs:pattern value="([^\t\n\r])*" /> </xs:restriction> </xs:simpleType> </xs:element></pre>		

element AddressType/D5004_BuildingNumber

diagram			
namespace	urn:bridgeall-com:cmaservice:data:v3		
type	restriction of xs:string		
properties	isRef	0	
	minOcc	0	
	maxOcc	1	
	content	simple	
facets	Kind	Value	annotation
	maxLength	4	
	pattern	([^\t\n\r])*	
source	<pre><xs:element name="D5004_BuildingNumber" minOccurs="0"> <xs:simpleType> <xs:restriction base="xs:string"> <xs:maxLength value="4"/> <xs:pattern value="([^\t\n\r])*" /> </xs:restriction> </xs:simpleType> </xs:element></pre>		

element AddressType/D5005_DependentThoroughfareName

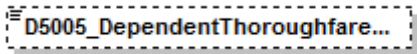
diagram			
namespace	urn:bridgeall-com:cmaservice:data:v3		
type	restriction of xs:string		
properties	isRef	0	
	minOcc	0	
	maxOcc	1	
	content	simple	
facets	Kind	Value	annotation
	maxLength	60	
	pattern	([^\t\n\r])*	
source	<pre><xs:element name="D5005_DependentThoroughfareName" minOccurs="0"> <xs:simpleType> <xs:restriction base="xs:string"> <xs:maxLength value="60"/> </xs:restriction> </xs:simpleType> </xs:element></pre>		

	<pre> <xs:pattern value="([\t\n\r])*"/> </xs:restriction> </xs:simpleType> </xs:element> </pre>
--	---

element AddressType/D5006_DependentThoroughfareDescriptor

diagram										
namespace	urn:bridgeall-com:cmaservice:data:v3									
type	restriction of xs:string									
properties	<table> <tr><td>isRef</td><td>0</td></tr> <tr><td>minOcc</td><td>0</td></tr> <tr><td>maxOcc</td><td>1</td></tr> <tr><td>content</td><td>simple</td></tr> </table>	isRef	0	minOcc	0	maxOcc	1	content	simple	
isRef	0									
minOcc	0									
maxOcc	1									
content	simple									
facets	<table> <tr><td>Kind</td><td>Value</td><td>annotation</td></tr> <tr><td>maxLength</td><td>20</td><td></td></tr> <tr><td>pattern</td><td>([\t\n\r])*</td><td></td></tr> </table>	Kind	Value	annotation	maxLength	20		pattern	([\t\n\r])*	
Kind	Value	annotation								
maxLength	20									
pattern	([\t\n\r])*									
source	<pre> <xs:element name="D5006_DependentThoroughfareDescriptor" minOccurs="0"> <xs:simpleType> <xs:restriction base="xs:string"> <xs:maxLength value="20"/> <xs:pattern value="([\t\n\r])*"/> </xs:restriction> </xs:simpleType> </xs:element> </pre>									

element AddressType/D5007_ThoroughfareName

diagram										
namespace	urn:bridgeall-com:cmaservice:data:v3									
type	restriction of xs:string									
properties	<table> <tr><td>isRef</td><td>0</td></tr> <tr><td>minOcc</td><td>0</td></tr> <tr><td>maxOcc</td><td>1</td></tr> <tr><td>content</td><td>simple</td></tr> </table>	isRef	0	minOcc	0	maxOcc	1	content	simple	
isRef	0									
minOcc	0									
maxOcc	1									
content	simple									
facets	<table> <tr><td>Kind</td><td>Value</td><td>annotation</td></tr> <tr><td>maxLength</td><td>60</td><td></td></tr> <tr><td>pattern</td><td>([\t\n\r])*</td><td></td></tr> </table>	Kind	Value	annotation	maxLength	60		pattern	([\t\n\r])*	
Kind	Value	annotation								
maxLength	60									
pattern	([\t\n\r])*									
source	<pre> <xs:element name="D5007_ThoroughfareName" minOccurs="0"> <xs:simpleType> <xs:restriction base="xs:string"> <xs:maxLength value="60"/> <xs:pattern value="([\t\n\r])*"/> </xs:restriction> </xs:simpleType> </xs:element> </pre>									

element **AddressType/D5008_ThoroughfareDescriptor**

diagram										
namespace	urn:bridgeall-com:cmaservice:data:v3									
type	restriction of xs:string									
properties	<table border="0"> <tr><td>isRef</td><td>0</td></tr> <tr><td>minOcc</td><td>0</td></tr> <tr><td>maxOcc</td><td>1</td></tr> <tr><td>content</td><td>simple</td></tr> </table>	isRef	0	minOcc	0	maxOcc	1	content	simple	
isRef	0									
minOcc	0									
maxOcc	1									
content	simple									
facets	<table border="0"> <tr><td>Kind</td><td>Value</td><td>annotation</td></tr> <tr><td>maxLength</td><td>20</td><td></td></tr> <tr><td>pattern</td><td colspan="2">([^\t\n\r])*</td></tr> </table>	Kind	Value	annotation	maxLength	20		pattern	([^\t\n\r])*	
Kind	Value	annotation								
maxLength	20									
pattern	([^\t\n\r])*									
source	<pre><xs:element name="D5008_ThoroughfareDescriptor" minOccurs="0"> <xs:simpleType> <xs:restriction base="xs:string"> <xs:maxLength value="20"/> <xs:pattern value="([^\t\n\r])*"/> </xs:restriction> </xs:simpleType> </xs:element></pre>									

element **AddressType/D5009_DoubleDependentLocality**

diagram										
namespace	urn:bridgeall-com:cmaservice:data:v3									
type	restriction of xs:string									
properties	<table border="0"> <tr><td>isRef</td><td>0</td></tr> <tr><td>minOcc</td><td>0</td></tr> <tr><td>maxOcc</td><td>1</td></tr> <tr><td>content</td><td>simple</td></tr> </table>	isRef	0	minOcc	0	maxOcc	1	content	simple	
isRef	0									
minOcc	0									
maxOcc	1									
content	simple									
facets	<table border="0"> <tr><td>Kind</td><td>Value</td><td>annotation</td></tr> <tr><td>maxLength</td><td>35</td><td></td></tr> <tr><td>pattern</td><td colspan="2">([^\t\n\r])*</td></tr> </table>	Kind	Value	annotation	maxLength	35		pattern	([^\t\n\r])*	
Kind	Value	annotation								
maxLength	35									
pattern	([^\t\n\r])*									
source	<pre><xs:element name="D5009_DoubleDependentLocality" minOccurs="0"> <xs:simpleType> <xs:restriction base="xs:string"> <xs:maxLength value="35"/> <xs:pattern value="([^\t\n\r])*"/> </xs:restriction> </xs:simpleType> </xs:element></pre>									

element **AddressType/D5010_DependentLocality**

diagram									
namespace	urn:bridgeall-com:cmaservice:data:v3								
type	restriction of xs:string								
properties	<table border="0"> <tr><td>isRef</td><td>0</td></tr> <tr><td>minOcc</td><td>0</td></tr> <tr><td>maxOcc</td><td>1</td></tr> <tr><td>content</td><td>simple</td></tr> </table>	isRef	0	minOcc	0	maxOcc	1	content	simple
isRef	0								
minOcc	0								
maxOcc	1								
content	simple								

facets	Kind maxLength pattern	Value 35 ([^\t\n\r])*	annotation
source	<pre><xs:element name="D5010_DependentLocality" minOccurs="0"> <xs:simpleType> <xs:restriction base="xs:string"> <xs:maxLength value="35"/> <xs:pattern value="([^\t\n\r])*"/> </xs:restriction> </xs:simpleType> </xs:element></pre>		

element **AddressType/D5011_PostTown**

diagram			
namespace	urn:bridgeall-com:cmaservice:data:v3		
type	restriction of xs:string		
properties	isRef	0	
	minOcc	0	
	maxOcc	1	
	content	simple	
facets	Kind maxLength pattern	Value 30 ([^\t\n\r])*	annotation
source	<pre><xs:element name="D5011_PostTown" minOccurs="0"> <xs:simpleType> <xs:restriction base="xs:string"> <xs:maxLength value="30"/> <xs:pattern value="([^\t\n\r])*"/> </xs:restriction> </xs:simpleType> </xs:element></pre>		

element **AddressType/D5012_County**

diagram			
namespace	urn:bridgeall-com:cmaservice:data:v3		
type	restriction of xs:string		
properties	isRef	0	
	minOcc	0	
	maxOcc	1	
	content	simple	
facets	Kind maxLength pattern	Value 30 ([^\t\n\r])*	annotation
source	<pre><xs:element name="D5012_County" minOccurs="0"> <xs:simpleType> <xs:restriction base="xs:string"> <xs:maxLength value="30"/> <xs:pattern value="([^\t\n\r])*"/> </xs:restriction> </xs:simpleType> </xs:element></pre>		

	<code></xs:element></code>
--	----------------------------------

element AddressType/D5013_Postcode

diagram	
namespace	urn:bridgeall-com:cmaservice:data:v3
type	PostcodeType
properties	isRef 0 minOcc 0 maxOcc 1 content complex
children	Outcode Incode
source	<code><xs:element name="D5013_Postcode" type="PostcodeType" minOccurs="0"/></code>

complexType CancelRegistrationNotificationOutType

diagram																			
namespace	urn:bridgeall-com:cmaservice:data:v3																		
type	extension of MessageBody																		
properties	base MessageBody																		
children	D2001_SPID																		
used by	element ResponseMessagesType/T011.1 CancelRegistrationNotification																		
attributes	<table border="1"> <thead> <tr> <th>Name</th> <th>Type</th> <th>Use</th> <th>Default</th> <th>Fixed</th> <th>annotation</th> </tr> </thead> <tbody> <tr> <td>MID</td> <td>MessageIdType</td> <td>required</td> <td></td> <td></td> <td></td> </tr> <tr> <td>RelatedMID</td> <td>MessageIdType</td> <td>optional</td> <td></td> <td></td> <td></td> </tr> </tbody> </table>	Name	Type	Use	Default	Fixed	annotation	MID	MessageIdType	required				RelatedMID	MessageIdType	optional			
Name	Type	Use	Default	Fixed	annotation														
MID	MessageIdType	required																	
RelatedMID	MessageIdType	optional																	
source	<pre> <xs:complexType name="CancelRegistrationNotificationOutType"> <xs:complexContent> <xs:extension base="MessageBody"> <xs:sequence> <xs:element ref="D2001_SPID"/> </xs:sequence> </xs:extension> </xs:complexContent> </pre>																		

</xs:complexType>

complexType CancelRegistrationNotificationType

diagram	<p>The diagram illustrates the structure of the <code>CancelRegistrationNotificationType</code> complex type. It is an extension of the <code>MessageBody</code> type. The extension includes an <code>attributes</code> container with two elements: <code>MID</code> (required) and <code>RelatedMID</code> (optional). Additionally, it includes three data elements: <code>D2001_SPID</code> (required), <code>D4003_Comment</code> (optional), and <code>D4005_CancellationCode</code> (optional). Descriptions for these elements are provided: <code>D2001_SPID</code> is a unique identifier for supply points and services; <code>D4003_Comment</code> is a text field for transaction-related notes; and <code>D4005_CancellationCode</code> is used to specify the reason for cancellation.</p>																		
namespace	urn:bridgeall-com:cmaservice:data:v3																		
type	extension of MessageBody																		
properties	base <code>MessageBody</code>																		
children	D2001_SPID D4003_Comment D4005_CancellationCode																		
used by	element ResponseMessagesType/T011.0_CancelRegistrationNotification																		
attributes	<table border="1"><thead><tr><th>Name</th><th>Type</th><th>Use</th><th>Default</th><th>Fixed</th><th>annotation</th></tr></thead><tbody><tr><td>MID</td><td>MessageIdType</td><td>required</td><td></td><td></td><td></td></tr><tr><td>RelatedMID</td><td>MessageIdType</td><td>optional</td><td></td><td></td><td></td></tr></tbody></table>	Name	Type	Use	Default	Fixed	annotation	MID	MessageIdType	required				RelatedMID	MessageIdType	optional			
Name	Type	Use	Default	Fixed	annotation														
MID	MessageIdType	required																	
RelatedMID	MessageIdType	optional																	
source	<pre><xs:complexType name="CancelRegistrationNotificationType"> <xs:complexContent> <xs:extension base="MessageBody"> <xs:sequence> <xs:element ref="D2001_SPID"/> <xs:element ref="D4003_Comment" minOccurs="0"/> <xs:element ref="D4005_CancellationCode" minOccurs="0"/> </xs:sequence> </xs:extension> </xs:complexContent> </xs:complexType></pre>																		

complexType **CancelRegistrationOutType**

<p>diagram</p>	<p>The diagram illustrates the structure of the CancelRegistrationOutType complex type, which is an extension of CancelRegistrationType. It features an attributes group containing MID (required) and RelatedMID (optional). The main content is a sequence of elements: D2001_SPID (required), D4005_CancellationCode (required), and D4003_Comment (optional). Descriptions for the elements are provided: D2001_SPID is a unique identifier for supply points and services; D4005_CancellationCode is used by LP to specify cancellation reasons; and D4003_Comment is a generic text field for short comments and notes.</p>																		
<p>namespace</p>	<p>urn:bridgeall-com:cmaservice:data:v3</p>																		
<p>type</p>	<p>extension of CancelRegistrationType</p>																		
<p>properties</p>	<p>base CancelRegistrationType</p>																		
<p>children</p>	<p>D2001_SPID D4005_CancellationCode D4003_Comment</p>																		
<p>used by</p>	<p>element MessagesType/T010.1_CancelRegistrations/T010.1_CancelRegistration</p>																		
<p>attributes</p>	<table border="1"> <thead> <tr> <th>Name</th> <th>Type</th> <th>Use</th> <th>Default</th> <th>Fixed</th> <th>annotation</th> </tr> </thead> <tbody> <tr> <td>MID</td> <td>MessageIdType</td> <td>required</td> <td></td> <td></td> <td></td> </tr> <tr> <td>RelatedMID</td> <td>MessageIdType</td> <td>optional</td> <td></td> <td></td> <td></td> </tr> </tbody> </table>	Name	Type	Use	Default	Fixed	annotation	MID	MessageIdType	required				RelatedMID	MessageIdType	optional			
Name	Type	Use	Default	Fixed	annotation														
MID	MessageIdType	required																	
RelatedMID	MessageIdType	optional																	
<p>source</p>	<pre><xs:complexType name="CancelRegistrationOutType"> <xs:complexContent> <xs:extension base="CancelRegistrationType"> <xs:sequence> <xs:element ref="D4003_Comment"/> </xs:sequence> </xs:extension> </xs:complexContent> </xs:complexType></pre>																		

complexType **CancelRegistrationType**

diagram						
namespace	urn:bridgeall-com:cmaservice:data:v3					
type	extension of MessageBody					
properties	base MessageBody					
children	D2001_SPID D4005_CancellationCode					
used by	element	MessagesType/T010.0_CancelRegistrations/T010.0_CancelRegistration				
	complexType	CancelRegistrationOutType				
attributes	Name	Type	Use	Default	Fixed	annotation
	MID	MessageIdType	required			
	RelatedMID	MessageIdType	optional			
source	<pre> <xs:complexType name="CancelRegistrationType"> <xs:complexContent> <xs:extension base="MessageBody"> <xs:sequence> <xs:element ref="D2001_SPID"/> <xs:element ref="D4005_CancellationCode"/> </xs:sequence> </xs:extension> </xs:complexContent> </xs:complexType> </pre>					

complexType **ChargeableMeterUpdateType**

<p>diagram</p>																			
<p>namespace</p>	<p>urn:bridgeall-com:cmaservice:data:v3</p>																		
<p>type</p>	<p>extension of MessageBody</p>																		
<p>properties</p>	<p>base MessageBody</p>																		
<p>children</p>	<p>D2001_SPID D3001_MeterId D3002_ChargeableMeterSize D3005_SewerageChargeableMeterSize D4003_Comment D3007_ReturnToSewerAllowance D4006_EffectiveFrom</p>																		
<p>used by</p>	<p>elements MessagesType/T014.0_ChargeableMeterUpdates/T014.0_ChargeableMeterUpdateResponseMessagesType/T014.1_MeterUpdateNotification</p>																		
<p>attributes</p>	<table border="1"> <thead> <tr> <th>Name</th> <th>Type</th> <th>Use</th> <th>Default</th> <th>Fixed</th> <th>annotation</th> </tr> </thead> <tbody> <tr> <td>MID</td> <td>MessageIdType</td> <td>required</td> <td></td> <td></td> <td></td> </tr> <tr> <td>RelatedMID</td> <td>MessageIdType</td> <td>optional</td> <td></td> <td></td> <td></td> </tr> </tbody> </table>	Name	Type	Use	Default	Fixed	annotation	MID	MessageIdType	required				RelatedMID	MessageIdType	optional			
Name	Type	Use	Default	Fixed	annotation														
MID	MessageIdType	required																	
RelatedMID	MessageIdType	optional																	
<p>annotation</p>	<p>documentation</p>																		
<p>source</p>	<pre><xs:complexType name="ChargeableMeterUpdateType"> <xs:annotation> <xs:documentation> </xs:documentation> </xs:complexType></pre>																		

```

</xs:annotation>
<xs:complexContent>
  <xs:extension base="MessageBody">
    <xs:sequence>
      <xs:element ref="D2001_SPID"/>
      <xs:element ref="D3001_MeterId"/>
      <xs:element ref="D3002_ChargeableMeterSize" minOccurs="0"/>
      <xs:element ref="D3005_SewerageChargeableMeterSize" minOccurs="0"/>
      <xs:element ref="D4003_Comment"/>
      <xs:element ref="D3007_ReturnToSewerAllowance" minOccurs="0"/>
      <xs:element ref="D4006_EffectiveFrom"/>
    </xs:sequence>
  </xs:extension>
</xs:complexContent>
</xs:complexType>

```

complexType ConnectionCompleteType

diagram																			
namespace	urn:bridgeall-com:cmaservice:data:v3																		
type	extension of MessageBody																		
properties	base MessageBody																		
children	D2001_SPID D2013_ConnectionDate																		
used by	elements MessagesType/T007.1_SewerageConnectionCompletes/T007.1_SewerageConnectionComplete_ResponseMessagesType/T007.2_ConnectionCompleteNotification																		
attributes	<table border="1"> <thead> <tr> <th>Name</th> <th>Type</th> <th>Use</th> <th>Default</th> <th>Fixed</th> <th>annotation</th> </tr> </thead> <tbody> <tr> <td>MID</td> <td>MessageIdType</td> <td>required</td> <td></td> <td></td> <td></td> </tr> <tr> <td>RelatedMID</td> <td>MessageIdType</td> <td>optional</td> <td></td> <td></td> <td></td> </tr> </tbody> </table>	Name	Type	Use	Default	Fixed	annotation	MID	MessageIdType	required				RelatedMID	MessageIdType	optional			
Name	Type	Use	Default	Fixed	annotation														
MID	MessageIdType	required																	
RelatedMID	MessageIdType	optional																	
annotation	documentation																		
source	<pre> <xs:complexType name="ConnectionCompleteType"> <xs:annotation> <xs:documentation> </xs:documentation> </xs:annotation> <xs:complexContent> <xs:extension base="MessageBody"> </pre>																		

```

<xs:sequence>
  <xs:element ref="D2001_SPID"/>
  <xs:element ref="D2013_ConnectionDate"/>
</xs:sequence>
</xs:extension>
</xs:complexContent>
</xs:complexType>

```

complexType **CustomerNameUpdatedNotificationType**

diagram						
namespace	urn:bridgeall-com:cmaservice:data:v3					
type	extension of MessageBody					
properties	base MessageBody					
children	D2001_SPID D2027_CustomerName D2028_CustomerNameType D4001_OrgId					
used by	element ResponseMessagesType/T032.2_CustomerNameUpdatedNotification					
attributes	Name	Type	Use	Default	Fixed	annotation
	MID	MessageIdType	required			
	RelatedMID	MessageIdType	optional			
annotation	documentation					
source	<pre> <xs:complexType name="CustomerNameUpdatedNotificationType"> <xs:annotation> <xs:documentation> </xs:documentation> </xs:annotation> <xs:complexContent> </pre>					

```

<xs:extension base="MessageBody">
  <xs:sequence>
    <xs:element ref="D2001_SPID"/>
    <xs:element ref="D2027_CustomerName"/>
    <xs:element ref="D2028_CustomerNameType"/>
    <xs:element ref="D4001_OrgId"/>
  </xs:sequence>
</xs:extension>
</xs:complexContent>
</xs:complexType>

```

complexType **DisconnectionType**

diagram						
namespace	urn:bridgeall-com:cmaservice:data:v3					
type	extension of MessageBody					
properties	base MessageBody					
children	D2001_SPID D4006_EffectiveFrom D2025_DisconnectionReconnection					
used by	elements MessagesType/T015.0_DisconnectionDeclarations/T015.0_DisconnectionDeclarationResponseMessagesType/T015.1_DisconnectionNotification					
attributes	Name	Type	Use	Default	Fixed	annotation
	MID	MessageIdType	required			
	RelatedMID	MessageIdType	optional			
annotation	documentation					
source	<pre> <xs:complexType name="DisconnectionType"> <xs:annotation> <xs:documentation> </xs:documentation> </xs:annotation> <xs:complexContent> <xs:extension base="MessageBody"> <xs:sequence> <xs:element ref="D2001_SPID"/> <xs:element ref="D4006_EffectiveFrom"/> </xs:sequence> </xs:extension> </xs:complexContent> </xs:complexType> </pre>					

```

<xs:element ref="D2025_DisconnectionReconnection"/>
</xs:sequence>
</xs:extension>
</xs:complexContent>
</xs:complexType>

```

complexType **DiscontinueDPIDType**

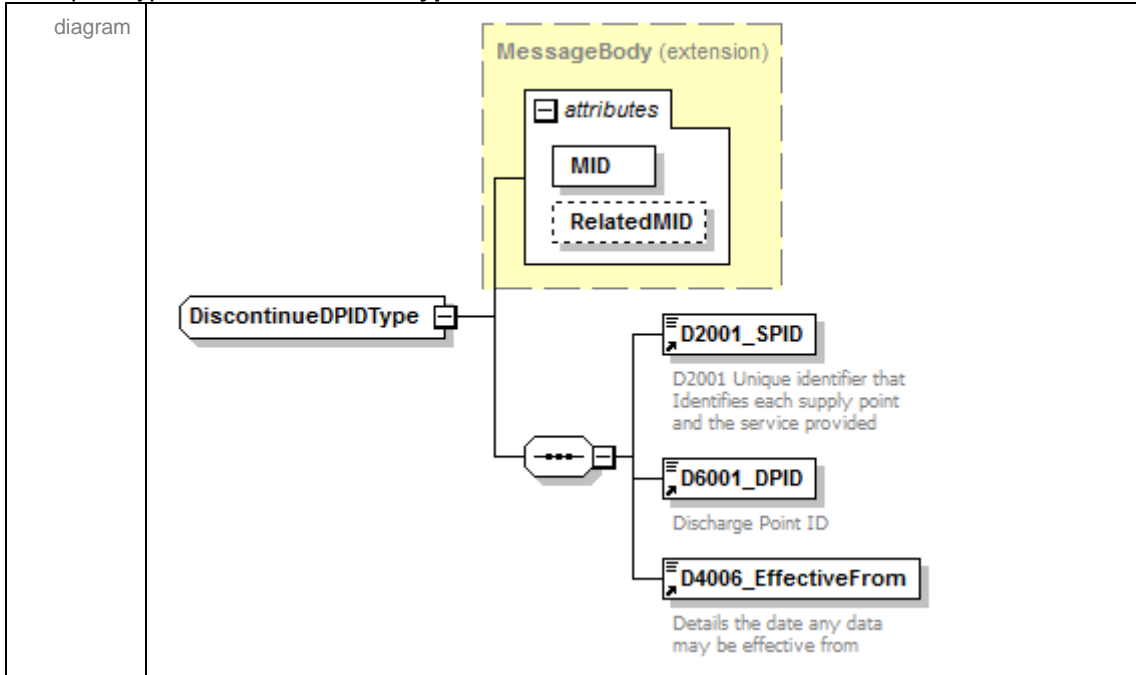

namespace	urn:bridgeall-com:cmaservice:data:v3					
type	extension of MessageBody					
properties	base MessageBody					
children	D2001_SPID D6001_DPID D4006_EffectiveFrom					
used by	elements MessagesType/T026.0_DiscontinueDPIDs/T026.0_DiscontinueDPIDResponseMessagesType/T026.1_DiscontinueDPIDNotification					
attributes	Name	Type	Use	Default	Fixed	annotation
	MID	MessageIdType	required			
	RelatedMID	MessageIdType	optional			
annotation	documentation					
source	<pre> <xs:complexType name="DiscontinueDPIDType"> <xs:annotation> <xs:documentation> </xs:documentation> </xs:annotation> <xs:complexContent> <xs:extension base="MessageBody"> <xs:sequence> <xs:element ref="D2001_SPID"/> <xs:element ref="D6001_DPID"/> <xs:element ref="D4006_EffectiveFrom"/> </xs:sequence> </xs:extension> </xs:complexContent> </xs:complexType> </pre>					

</xs:complexType>

complexType **DPIDNotificationType**

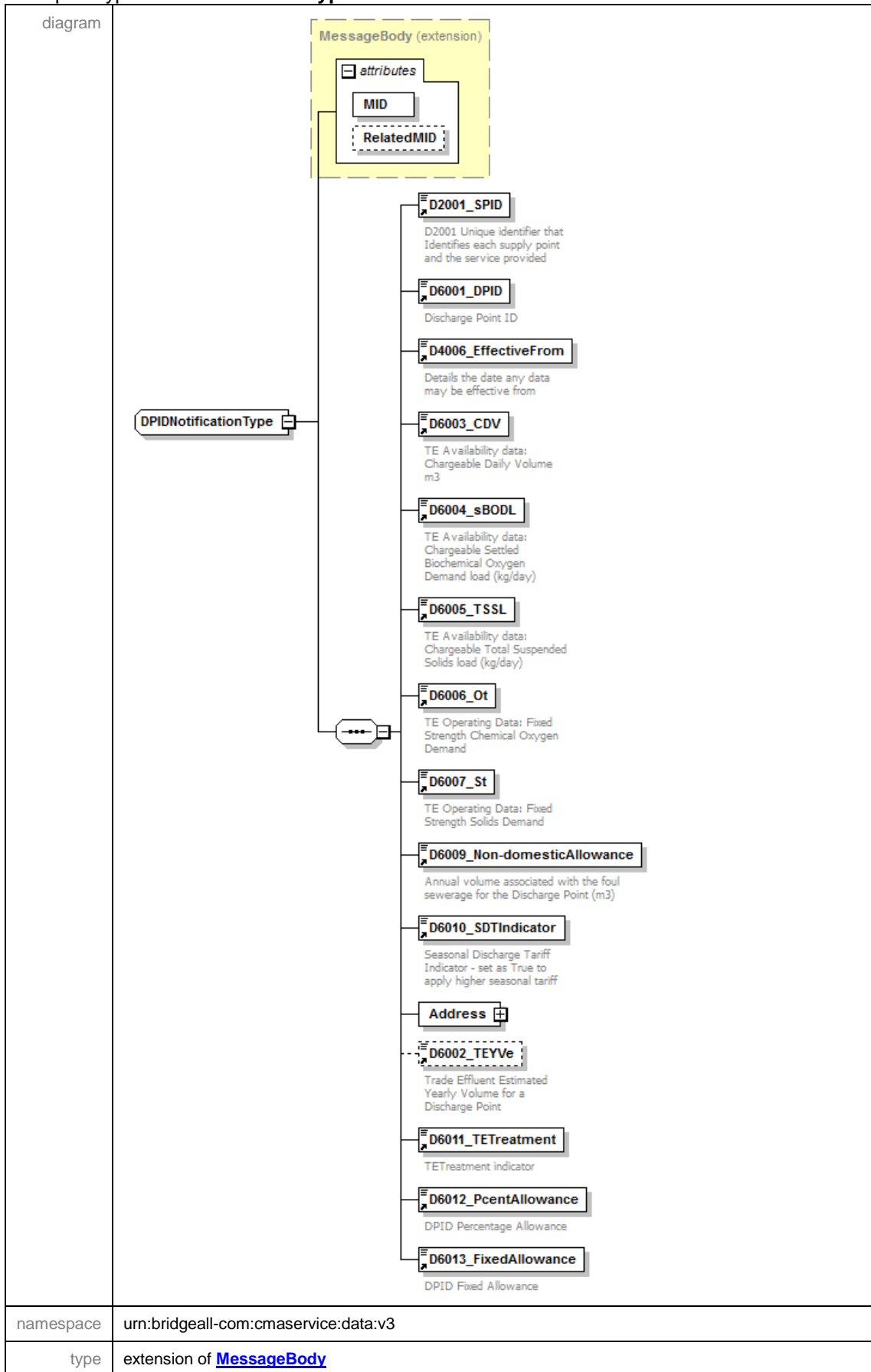

properties	base MessageBody					
children	D2001_SPID D6001_DPID D4006_EffectiveFrom D6003_CDV D6004_sBODL D6005_TSSL D6006_Ot D6007_St D6009_Non-domesticAllowance D6010_SDTIndicator Address D6002_TeYVe D6011_TETreatment D6012_PcentAllowance D6013_FixedAllowance					
used by	elements	MessagesType/T021.0_NewDPIDs/T021.0_NewDPID ResponseMessagesType/T021.1_DPIDNotification				
attributes	Name	Type	Use	Default	Fixed	annotation
	MID	MessageIdType	required			
	RelatedMID	MessageIdType	optional			
annotation	documentation					
source	<pre> <xs:complexType name="DPIDNotificationType"> <xs:annotation> <xs:documentation> </xs:documentation> </xs:annotation> <xs:complexContent> <xs:extension base="MessageBody"> <xs:sequence> <xs:element ref="D2001_SPID"/> <xs:element ref="D6001_DPID"/> <xs:element ref="D4006_EffectiveFrom"/> <xs:element ref="D6003_CDV"/> <xs:element ref="D6004_sBODL"/> <xs:element ref="D6005_TSSL"/> <xs:element ref="D6006_Ot"/> <xs:element ref="D6007_St"/> <xs:element ref="D6009_Non-domesticAllowance"/> <xs:element ref="D6010_SDTIndicator"/> <xs:element name="Address" type="AddressType"/> <xs:element ref="D6002_TeYVe" minOccurs="0"/> <xs:element ref="D6011_TETreatment"/> <xs:element ref="D6012_PcentAllowance"/> <xs:element ref="D6013_FixedAllowance"/> </xs:sequence> </xs:extension> </xs:complexContent> </xs:complexType> </pre>					

element **DPIDNotificationType/Address**

<p>diagram</p>	
<p>namespace</p>	<p>urn:bridgeall-com:cmaservice:data:v3</p>
<p>type</p>	<p>AddressType</p>
<p>properties</p>	<p>isRef 0 content complex</p>
<p>children</p>	<p>D5001_FreeDescriptor D5002_SubBuildingName D5003_BuildingName D5004_BuildingNumber D5005_DependentThoroughfareName D5006_DependentThoroughfareDescriptor D5007_ThoroughfareName D5008_ThoroughfareDescriptor D5009_DoubleDependentLocality D5010_DependentLocality D5011_PostTown D5012_County D5013_Postcode</p>
<p>source</p>	<p><xs:element name="Address" type="AddressType"/></p>

complexType **DPIDUpdateType**

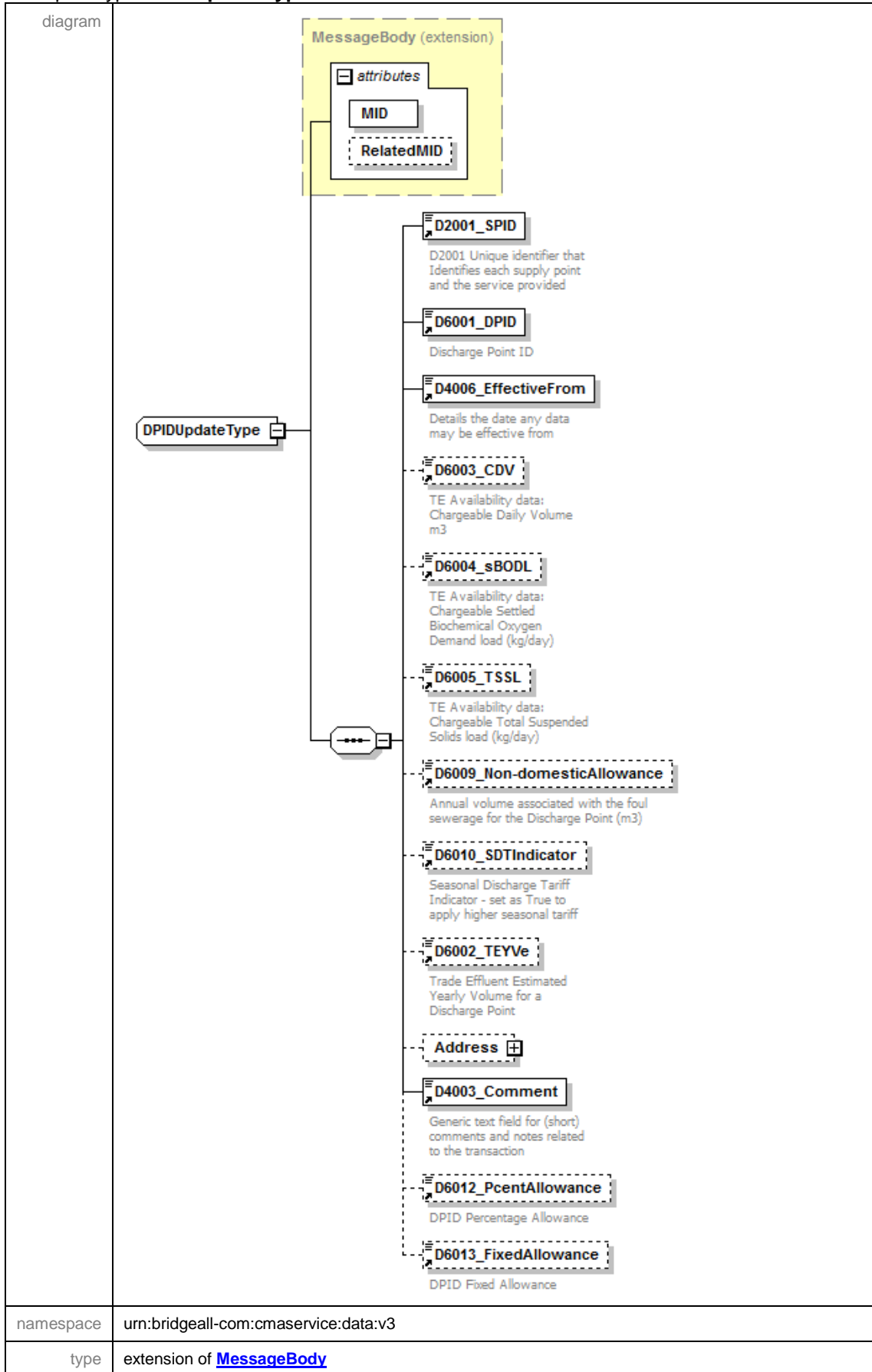

properties	base MessageBody					
children	D2001_SPID D6001_DPID D4006_EffectiveFrom D6003_CDV D6004_sBODL D6005_TSSL D6009_Non-domesticAllowance D6010_SDTIndicator D6002_TEYVe Address D4003_Comment D6012_PcentAllowance D6013_FixedAllowance					
used by	elements	MessagesType/T027.0_DPIDUpdates/T027.0_DPIDUpdateResponseMessagesType/T027.1_DPIDUpdateNotification				
attributes	Name	Type	Use	Default	Fixed	annotation
	MID	MessageIdType	required			
	RelatedMID	MessageIdType	optional			
annotation	documentation					
source	<pre> <xs:complexType name="DPIDUpdateType"> <xs:annotation> <xs:documentation> </xs:documentation> </xs:annotation> <xs:complexContent> <xs:extension base="MessageBody"> <xs:sequence> <xs:element ref="D2001_SPID"/> <xs:element ref="D6001_DPID"/> <xs:element ref="D4006_EffectiveFrom"/> <xs:element ref="D6003_CDV" minOccurs="0"/> <xs:element ref="D6004_sBODL" minOccurs="0"/> <xs:element ref="D6005_TSSL" minOccurs="0"/> <xs:element ref="D6009_Non-domesticAllowance" minOccurs="0"/> <xs:element ref="D6010_SDTIndicator" minOccurs="0"/> <xs:element ref="D6002_TEYVe" minOccurs="0"/> <xs:element name="Address" type="AddressType" minOccurs="0"/> <xs:element ref="D4003_Comment"/> <xs:element ref="D6012_PcentAllowance" minOccurs="0"/> <xs:element ref="D6013_FixedAllowance" minOccurs="0"/> </xs:sequence> </xs:extension> </xs:complexContent> </xs:complexType> </pre>					

element **DPIDUpdateType/Address**

<p>diagram</p>	
<p>namespace</p>	<p>urn:bridgeall-com:cmaservice:data:v3</p>
<p>type</p>	<p>AddressType</p>
<p>properties</p>	<p>isRef 0 minOcc 0 maxOcc 1 content complex</p>
<p>children</p>	<p>D5001_FreeDescriptor D5002_SubBuildingName D5003_BuildingName D5004_BuildingNumber D5005_DependentThoroughfareName D5006_DependentThoroughfareDescriptor D5007_ThoroughfareName D5008_ThoroughfareDescriptor D5009_DoubleDependentLocality D5010_DependentLocality D5011_PostTown D5012_County D5013_Postcode</p>
<p>source</p>	<p><xs:element name="Address" type="AddressType" minOccurs="0"/></p>

complexType **DPMeterReadType**

<p>diagram</p>																			
<p>namespace</p>	<p>urn:bridgeall-com:cmaservice:data:v3</p>																		
<p>type</p>	<p>extension of MessageBody</p>																		
<p>properties</p>	<p>base MessageBody</p>																		
<p>children</p>	<p>D2001_SPID D6001_DPID D3001_MeterId D3008_MeterRead D3009_MeterReadDate D3010_MeterReadType D3012_ReRead D3021_Rollover_Flag</p>																		
<p>used by</p>	<p>elements ResponseMessagesType/T030.0 DPMeterReadNotification ResponseMessagesType/T030.1 DPMeterReadNotification</p>																		
<p>attributes</p>	<table border="1"> <thead> <tr> <th>Name</th> <th>Type</th> <th>Use</th> <th>Default</th> <th>Fixed</th> <th>annotation</th> </tr> </thead> <tbody> <tr> <td>MID</td> <td>MessageIdType</td> <td>required</td> <td></td> <td></td> <td></td> </tr> <tr> <td>RelatedMID</td> <td>MessageIdType</td> <td>optional</td> <td></td> <td></td> <td></td> </tr> </tbody> </table>	Name	Type	Use	Default	Fixed	annotation	MID	MessageIdType	required				RelatedMID	MessageIdType	optional			
Name	Type	Use	Default	Fixed	annotation														
MID	MessageIdType	required																	
RelatedMID	MessageIdType	optional																	
<p>annotation</p>	<p>documentation</p>																		
<p>source</p>	<pre><xs:complexType name="DPMeterReadType"> <xs:annotation></pre>																		

```

<xs:documentation>
  </xs:documentation>
</xs:annotation>
<xs:complexContent>
  <xs:extension base="MessageBody">
    <xs:sequence>
      <xs:element ref="D2001_SPID" minOccurs="0"/>
      <xs:element ref="D6001_DPID"/>
      <xs:element ref="D3001_MeterId"/>
      <xs:element ref="D3008_MeterRead"/>
      <xs:element ref="D3009_MeterReadDate"/>
      <xs:element ref="D3010_MeterReadType"/>
      <xs:element ref="D3012_ReRead"/>
      <xs:element ref="D3021_Rollover_Flag"/>
    </xs:sequence>
  </xs:extension>
</xs:complexContent>
</xs:complexType>

```

complexType **LPMeterUpdateType**

diagram																			
namespace	urn:bridgeall-com:cmaservice:data:v3																		
type	extension of MessageBody																		
properties	base MessageBody																		
children	D2001_SPID D3001_MeterId D2010_YVe																		
used by	element MessagesType/T004.2 LPMeterUpdates/T004.2 LPMeterUpdate																		
attributes	<table border="1"> <thead> <tr> <th>Name</th> <th>Type</th> <th>Use</th> <th>Default</th> <th>Fixed</th> <th>annotation</th> </tr> </thead> <tbody> <tr> <td>MID</td> <td>MessageIdType</td> <td>required</td> <td></td> <td></td> <td></td> </tr> <tr> <td>RelatedMID</td> <td>MessageIdType</td> <td>optional</td> <td></td> <td></td> <td></td> </tr> </tbody> </table>	Name	Type	Use	Default	Fixed	annotation	MID	MessageIdType	required				RelatedMID	MessageIdType	optional			
Name	Type	Use	Default	Fixed	annotation														
MID	MessageIdType	required																	
RelatedMID	MessageIdType	optional																	
annotation	documentation																		
source	<xs:complexType name="LPMeterUpdateType">																		

```

<xs:annotation>
  <xs:documentation>
    </xs:documentation>
  </xs:annotation>
<xs:complexContent>
  <xs:extension base="MessageBody">
    <xs:sequence>
      <xs:element ref="D2001_SPID"/>
      <xs:element ref="D3001_MeterId"/>
      <xs:element ref="D2010_YVe"/>
    </xs:sequence>
  </xs:extension>
</xs:complexContent>
</xs:complexType>

```

complexType **MessageBody**

diagram	
namespace	urn:bridgeall-com:cmaservice:data:v3
properties	abstract true
used by	<p>complexTypes</p> <p> CancelRegistrationNotificationOutType CancelRegistrationNotificationType CancelRegistrationType ChargeableMeterUpdateType ConnectionCompleteType CustomerNameUpdatedNotificationType DisconnectionType DiscontinueDPIDType DPIDNotificationType DPIDUpdateType DPMeterReadType LPMeterUpdateType MeterAssociationType MeterDisAssociationType MeterNetworkAssociationType MeterReadNotificationType MeterReadType MeterSwapNotificationType MeterSwapType MeterUpdateNotificationType MeterUpdateType NewLPSPIDNotificationType NewSPIDNotificationType NewSPIDRequestType NotificationType NotifyRSDType PartialRegistrationApplicationType PremisesSpecialArrangementsUpdateNotificationType PremisesSpecialArrangementsUpdateType RegistrationStartType Schedule3UpdateType ServiceElementUpdateNotificationType SewerageServiceElementUpdateNotificationType SewerageSPIDDataType SpecialArrangementsUpdateNotificationType SpecialArrangementsUpdateType T003.1 RegistrationApplicationType T004.0 NewMeterType T004.1 NewMeterNotificationType T004.3 VirtualMeterType T006.0 LPWaterSPIDUpdateType T006.1 LPSewerageSPIDUpdateType T006.2 WaterSPIDUpdateType T006.3 SewerageSPIDUpdateType T006.4 WaterSPIDNotificationType T006.5 SewerageSPIDNotificationType T007.0 WaterConnectionCompleteType T009.4 NotificationType T012.0 MiscSPIDUpdateType T012.1 ServiceElementUpdateType T012.3 SewerageServiceElementUpdateType T016.0 UnmeasureableDeclarationType T032.0 CreateUpdateCustomerNameType T032.1 CustomerNameUpdatedType T033.0 MeteredBuilding T033.1 MeteredBuildingUpdate T034.0 VacSchemeApplication T034.1 VacSchemeGracePeriodNotification T034.2 VacSchemeGraceEndNotification T034.3 VacSchemeApplicationNotification T034.4 VacSchemeApplicationConfirmationOrCancellation T034.5 VacSchemeApplicationConfirmationOrCancellationNotification T035.0 TradeabilityNotification T035.1 TradeabilityNotification TEUpdateType UpdateMeterLocationNotificationType UpdateMeterLocationType UpdateSAARreferenceNumberUPRNNotificationType UpdateSAARreferenceNumberUPRNTType WaterSPIDDataType </p>

attributes	Name	Type	Use	Default	Fixed	annotation
	MID	MessageIdType	required			
	RelatedMID	MessageIdType	optional			
source	<pre><xs:complexType name="MessageBody" abstract="true"> <xs:attribute name="MID" type="MessageIdType" use="required"/> <xs:attribute name="RelatedMID" type="MessageIdType" use="optional"/> </xs:complexType></pre>					

attribute **MessageBody/@MID**

type	MessageIdType					
properties	isRef	0	use	required		
facets	Kind	Value			annotation	
	minLength	16				
	maxLength	16				
	pattern	([a-z][A-Z][0-9])*				
source	<pre><xs:attribute name="MID" type="MessageIdType" use="required"/></pre>					

attribute **MessageBody/@RelatedMID**

type	MessageIdType					
properties	isRef	0	use	optional		
facets	Kind	Value			annotation	
	minLength	16				
	maxLength	16				
	pattern	([a-z][A-Z][0-9])*				
source	<pre><xs:attribute name="RelatedMID" type="MessageIdType" use="optional"/></pre>					

complexType MessagesType

<p>diagram</p>	<p>The diagram illustrates the structure of the MessagesType complex type. A central box labeled 'MessagesType' is connected to a vertical list of 40 message type boxes. Each box in the list contains a message type name followed by a plus icon, indicating that the MessagesType contains these elements. The message types listed are:</p> <ul style="list-style-type: none"> T001.0_NewSPIDRequests T003.0_PartialRegistrationAppli... T003.1_RegistrationApplications T004.0_NewMeters T004.2_LPMeterUpdates T004.3_VirtualMeters T005.0_SWMeterReads T005.1_LPMeterReads T006.0_LPWaterSPIDUpdates T006.1_LPSewerageSPIDUpdates T006.2_WaterSPIDUpdates T006.3_SewerageSPIDUpdates T007.0_WaterConnectionCompl... T007.1_SewerageConnectionC... T009.2_Notifications T009.3_Notifications T010.0_CancelRegistrations T010.1_CancelRegistrations T012.0_MiscSPIDUpdates T012.1_ServiceElementUpdates T012.3_SewerageServiceEleme... T012.5_UpdateSAAReferenceNu... T013.0_MeterUpdates T013.2_UpdateMeterLocations T014.0_ChargeableMeterUpdates T015.0_DisconnectionDeclaratio... T016.0_UnmeasureableDeclarat... T017.0_MeterSwaps T021.0_NewDPIDs T022.0_TEUpdates T023.0_MeterAssociations T024.0_MeterDisAssociations T026.0_DiscontinueDPIDs T027.0_DPIDUpdates T028.1_Schedule3Updates T029.1_SpecialArrangementsU... T029.3_Premises SpecialArrang... T032.0_CreateUpdateCustomer... T033.0_MeteredBuildings T034.0_VacSchemeApplications T034.4_VacSchemeApplication... T036.0_MeterNetworkAssociati...
<p>namespace</p>	<p>urn:bridgeall-com:cmaservice:data:v3</p>
<p>children</p>	<p>T001.0 NewSPIDRequests T003.0 PartialRegistrationApplications T003.1 RegistrationApplications T004.0 NewMeters T004.2 LPMeterUpdates</p>

	T004.3 VirtualMeters T005.0 SWMeterReads T005.1 LPMeterReads T006.0 LPWaterSPIDUpdates T006.1 LPsewerageSPIDUpdates T006.2 WaterSPIDUpdates T006.3 SewerageSPIDUpdates T007.0 WaterConnectionCompletes T007.1 SewerageConnectionCompletes T009.2 Notifications T009.3 Notifications T010.0 CancelRegistrations T010.1 CancelRegistrations T012.0 MiscSPIDUpdates T012.1 ServiceElementUpdates T012.3 SewerageServiceElementUpdates T012.5 UpdateSAAReferenceNumberUPRNs T013.0 MeterUpdates T013.2 UpdateMeterLocations T014.0 ChargeableMeterUpdates T015.0 DisconnectionDeclarations T016.0 UnmeasureableDeclarations T017.0 MeterSwaps T021.0 NewDPIDs T022.0 TEUpdates T023.0 MeterAssociations T024.0 MeterDisAssociations T026.0 DiscontinueDPIDs T027.0 DPIDUpdates T028.1 Schedule3Updates T029.1 SpecialArrangementsUpdates T029.3 PremisesSpecialArrangementsUpdates T032.0 CreateUpdateCustomerName T033.0 MeteredBuildings T034.0 VacSchemeApplications T034.4 VacSchemeApplicationConfirmationOrCancellations T036.0 MeterNetworkAssociations
used by	element Messages
source	<pre> <xs:complexType name="MessagesType"> <xs:choice> <xs:element name="T001.0_NewSPIDRequests"> <xs:complexType> <xs:sequence maxOccurs="unbounded"> <xs:element name="T001.0_NewSPIDRequest" type="NewSPIDRequestType"/> </xs:sequence> </xs:complexType> </xs:element> <xs:element name="T003.0_PartialRegistrationApplications"> <xs:complexType> <xs:sequence maxOccurs="unbounded"> <xs:element name="T003.0_PartialRegistrationApplication" type="PartialRegistrationApplicationType"/> </xs:sequence> </xs:complexType> </xs:element> <xs:element name="T003.1_RegistrationApplications"> <xs:complexType> <xs:sequence maxOccurs="unbounded"> <xs:element name="T003.1_RegistrationApplication" type="T003.1_RegistrationApplicationType"/> </xs:sequence> </xs:complexType> </xs:element> <xs:element name="T004.0_NewMeters"> <xs:complexType> <xs:sequence maxOccurs="unbounded"> <xs:element name="T004.0_NewMeter" type="T004.0_NewMeterType"/> </xs:sequence> </xs:complexType> </xs:element> <xs:element name="T004.2_LPMeterUpdates"> <xs:complexType> <xs:sequence maxOccurs="unbounded"> <xs:element name="T004.2_LPMeterUpdate" type="LPMeterUpdateType"/> </xs:sequence> </xs:complexType> </xs:element> <xs:element name="T004.3_VirtualMeters"> <xs:complexType> <xs:sequence maxOccurs="unbounded"> <xs:element name="T004.3_VirtualMeter" </pre>

```

type="T004.3_VirtualMeterType"/>
  </xs:sequence>
</xs:complexType>
</xs:element>
<xs:element name="T005.0_SWMeterReads">
  <xs:complexType>
    <xs:sequence maxOccurs="unbounded">
      <xs:element name="T005.0_SWMeterRead" type="MeterReadType"/>
    </xs:sequence>
  </xs:complexType>
</xs:element>
<xs:element name="T005.1_LPMeterReads">
  <xs:complexType>
    <xs:sequence maxOccurs="unbounded">
      <xs:element name="T005.1_LPMeterRead" type="MeterReadType"/>
    </xs:sequence>
  </xs:complexType>
</xs:element>
<xs:element name="T006.0_LPWaterSPIDUpdates">
  <xs:complexType>
    <xs:sequence maxOccurs="unbounded">
      <xs:element name="T006.0_LPWaterSPIDUpdate"
type="T006.0_LPWaterSPIDUpdateType"/>
    </xs:sequence>
  </xs:complexType>
</xs:element>
<xs:element name="T006.1_LPSewerageSPIDUpdates">
  <xs:complexType>
    <xs:sequence maxOccurs="unbounded">
      <xs:element name="T006.1_LPSewerageSPIDUpdate"
type="T006.1_LPSewerageSPIDUpdateType"/>
    </xs:sequence>
  </xs:complexType>
</xs:element>
<xs:element name="T006.2_WaterSPIDUpdates">
  <xs:complexType>
    <xs:sequence maxOccurs="unbounded">
      <xs:element name="T006.2_WaterSPIDUpdate"
type="T006.2_WaterSPIDUpdateType"/>
    </xs:sequence>
  </xs:complexType>
</xs:element>
<xs:element name="T006.3_SewerageSPIDUpdates">
  <xs:complexType>
    <xs:sequence maxOccurs="unbounded">
      <xs:element name="T006.3_SewerageSPIDUpdate"
type="T006.3_SewerageSPIDUpdateType"/>
    </xs:sequence>
  </xs:complexType>
</xs:element>
<xs:element name="T007.0_WaterConnectionCompletes">
  <xs:complexType>
    <xs:sequence maxOccurs="unbounded">
      <xs:element name="T007.0_WaterConnectionComplete"
type="T007.0_WaterConnectionCompleteType"/>
    </xs:sequence>
  </xs:complexType>
</xs:element>
<xs:element name="T007.1_SewerageConnectionCompletes">

```

```

<xs:complexType>
  <xs:sequence maxOccurs="unbounded">
    <xs:element name="T007.1_SewerageConnectionComplete"
type="ConnectionCompleteType"/>
  </xs:sequence>
</xs:complexType>
</xs:element>
<xs:element name="T009.2_Notifications">
  <xs:complexType>
    <xs:sequence maxOccurs="unbounded">
      <xs:element name="T009.2_Notification" type="NotificationType"/>
    </xs:sequence>
  </xs:complexType>
</xs:element>
<xs:element name="T009.3_Notifications">
  <xs:complexType>
    <xs:sequence maxOccurs="unbounded">
      <xs:element name="T009.3_Notification" type="NotificationType"/>
    </xs:sequence>
  </xs:complexType>
</xs:element>
<xs:element name="T010.0_CancelRegistrations">
  <xs:complexType>
    <xs:sequence maxOccurs="unbounded">
      <xs:element name="T010.0_CancelRegistration"
type="CancelRegistrationType"/>
    </xs:sequence>
  </xs:complexType>
</xs:element>
<xs:element name="T010.1_CancelRegistrations">
  <xs:complexType>
    <xs:sequence maxOccurs="unbounded">
      <xs:element name="T010.1_CancelRegistration"
type="CancelRegistrationOutType"/>
    </xs:sequence>
  </xs:complexType>
</xs:element>
<xs:element name="T012.0_MiscSPIDUpdates">
  <xs:complexType>
    <xs:sequence maxOccurs="unbounded">
      <xs:element name="T012.0_MiscSPIDUpdate"
type="T012.0_MiscSPIDUpdateType"/>
    </xs:sequence>
  </xs:complexType>
</xs:element>
<xs:element name="T012.1_ServiceElementUpdates">
  <xs:complexType>
    <xs:sequence maxOccurs="unbounded">
      <xs:element name="T012.1_ServiceElementUpdate"
type="T012.1_ServiceElementUpdateType"/>
    </xs:sequence>
  </xs:complexType>
</xs:element>
<xs:element name="T012.3_SewerageServiceElementUpdates">
  <xs:complexType>
    <xs:sequence maxOccurs="unbounded">
      <xs:element name="T012.3_SewerageServiceElementUpdate"
type="T012.3_SewerageServiceElementUpdateType"/>
    </xs:sequence>
  </xs:complexType>
</xs:element>

```

```

</xs:complexType>
</xs:element>
<xs:element name="T012.5_UpdateSAAReferenceNumberUPRNs">
  <xs:complexType>
    <xs:sequence maxOccurs="unbounded">
      <xs:element name="T012.5_UpdateSAAReferenceNumberUPRN"
type="UpdateSAAReferenceNumberUPRNType"/>
    </xs:sequence>
  </xs:complexType>
</xs:element>
<xs:element name="T013.0_MeterUpdates">
  <xs:complexType>
    <xs:sequence maxOccurs="unbounded">
      <xs:element name="T013.0_MeterUpdate" type="MeterUpdateType"/>
    </xs:sequence>
  </xs:complexType>
</xs:element>
<xs:element name="T013.2_UpdateMeterLocations">
  <xs:complexType>
    <xs:sequence maxOccurs="unbounded">
      <xs:element name="T013.2_UpdateMeterLocation"
type="UpdateMeterLocationType"/>
    </xs:sequence>
  </xs:complexType>
</xs:element>
<xs:element name="T014.0_ChargeableMeterUpdates">
  <xs:complexType>
    <xs:sequence maxOccurs="unbounded">
      <xs:element name="T014.0_ChargeableMeterUpdate"
type="ChargeableMeterUpdateType"/>
    </xs:sequence>
  </xs:complexType>
</xs:element>
<xs:element name="T015.0_DisconnectionDeclarations">
  <xs:complexType>
    <xs:sequence maxOccurs="unbounded">
      <xs:element name="T015.0_DisconnectionDeclaration"
type="DisconnectionType"/>
    </xs:sequence>
  </xs:complexType>
</xs:element>
<xs:element name="T016.0_UnmeasureableDeclarations">
  <xs:complexType>
    <xs:sequence maxOccurs="unbounded">
      <xs:element name="T016.0_UnmeasureableDeclaration"
type="T016.0_UnmeasureableDeclarationType"/>
    </xs:sequence>
  </xs:complexType>
</xs:element>
<xs:element name="T017.0_MeterSwaps">
  <xs:complexType>
    <xs:sequence maxOccurs="unbounded">
      <xs:element name="T017.0_MeterSwap" type="MeterSwapType"/>
    </xs:sequence>
  </xs:complexType>
</xs:element>
<xs:element name="T021.0_NewDPIDs">
  <xs:complexType>
    <xs:sequence maxOccurs="unbounded">

```

```

        <xs:element name="T021.0_NewDPID" type="DPIDNotificationType"/>
    </xs:sequence>
</xs:complexType>
</xs:element>
<xs:element name="T022.0_TEUpdates">
    <xs:complexType>
        <xs:sequence maxOccurs="unbounded">
            <xs:element name="T022.0_TEUpdate" type="TEUpdateType"/>
        </xs:sequence>
    </xs:complexType>
</xs:element>
<xs:element name="T023.0_MeterAssociations">
    <xs:complexType>
        <xs:sequence maxOccurs="unbounded">
            <xs:element name="T023.0_MeterAssociation"
type="MeterAssociationType"/>
        </xs:sequence>
    </xs:complexType>
</xs:element>
<xs:element name="T024.0_MeterDisAssociations">
    <xs:complexType>
        <xs:sequence maxOccurs="unbounded">
            <xs:element name="T024.0_MeterDisAssociation"
type="MeterDisAssociationType"/>
        </xs:sequence>
    </xs:complexType>
</xs:element>
<xs:element name="T026.0_DiscontinueDPIDs">
    <xs:complexType>
        <xs:sequence maxOccurs="unbounded">
            <xs:element name="T026.0_DiscontinueDPID"
type="DiscontinueDPIDType"/>
        </xs:sequence>
    </xs:complexType>
</xs:element>
<xs:element name="T027.0_DPIDUpdates">
    <xs:complexType>
        <xs:sequence maxOccurs="unbounded">
            <xs:element name="T027.0_DPIDUpdate" type="DPIDUpdateType"/>
        </xs:sequence>
    </xs:complexType>
</xs:element>
<xs:element name="T028.1_Schedule3Updates">
    <xs:complexType>
        <xs:sequence maxOccurs="unbounded">
            <xs:element name="T028.1_Schedule3Update"
type="Schedule3UpdateType"/>
        </xs:sequence>
    </xs:complexType>
</xs:element>
<xs:element name="T029.1_SpecialArrangementsUpdates">
    <xs:complexType>
        <xs:sequence maxOccurs="unbounded">
            <xs:element name="T029.1_SpecialArrangementsUpdate"
type="SpecialArrangementsUpdateType"/>
        </xs:sequence>
    </xs:complexType>
</xs:element>
<xs:element name="T029.3_PremisesSpecialArrangementsUpdates">

```

```

<xs:complexType>
  <xs:sequence maxOccurs="unbounded">
    <xs:element name="T029.3_PremisesSpecialArrangementsUpdate"
type="PremisesSpecialArrangementsUpdateType"/>
  </xs:sequence>
</xs:complexType>
</xs:element>
<xs:element name="T032.0_CreateUpdateCustomerName">
  <xs:complexType>
    <xs:sequence maxOccurs="unbounded">
      <xs:element name="T032.0_CreateUpdateCustomerName"
type="T032.0_CreateUpdateCustomerNameType"/>
    </xs:sequence>
  </xs:complexType>
</xs:element>
<xs:element name="T033.0_MeteredBuildings">
  <xs:complexType>
    <xs:sequence maxOccurs="unbounded">
      <xs:element name="T033.0_MeteredBuilding"
type="T033.0_MeteredBuilding"/>
    </xs:sequence>
  </xs:complexType>
</xs:element>
<xs:element name="T034.0_VacSchemeApplications">
  <xs:complexType>
    <xs:sequence maxOccurs="unbounded">
      <xs:element name="T034.0_VacSchemeApplication"
type="T034.0_VacSchemeApplication"/>
    </xs:sequence>
  </xs:complexType>
</xs:element>
<xs:element
name="T034.4_VacSchemeApplicationConfirmationOrCancellations">
  <xs:complexType>
    <xs:sequence maxOccurs="unbounded">
      <xs:element
name="T034.4_VacSchemeApplicationConfirmationOrCancellation"
type="T034.4_VacSchemeApplicationConfirmationOrCancellation"/>
    </xs:sequence>
  </xs:complexType>
</xs:element>
<xs:element name="T036.0_MeterNetworkAssociations">
  <xs:complexType>
    <xs:sequence maxOccurs="unbounded">
      <xs:element name="T036.0_MeterNetworkAssociation"
type="MeterNetworkAssociationType"/>
    </xs:sequence>
  </xs:complexType>
</xs:element>
</xs:choice>
</xs:complexType>

```

element **MessagesType/T001.0_NewSPIDRequests**

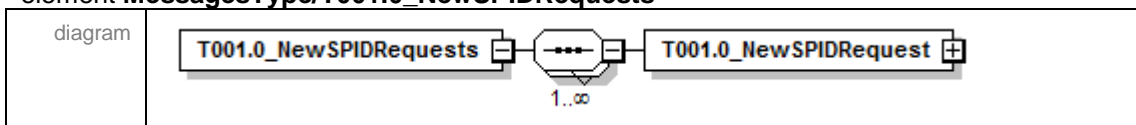

namespace	urn:bridgeall-com:cmaservice:data:v3
properties	isRef 0 content complex
children	T001.0_NewSPIDRequest
source	<pre> <xs:element name="T001.0_NewSPIDRequests"> <xs:complexType> <xs:sequence maxOccurs="unbounded"> <xs:element name="T001.0_NewSPIDRequest" type="NewSPIDRequestType"/> </xs:sequence> </xs:complexType> </xs:element> </pre>

element **MessagesType/T001.0_NewSPIDRequests/T001.0_NewSPIDRequest**

diagram	
namespace	urn:bridgeall-com:cmaservice:data:v3
type	NewSPIDRequestType
properties	isRef 0 content complex
children	D2001_SPID D2009_SWConnectionRef D4001_OrgId D2002_ServiceCategory SPIDLocation D2023_NewConnectionType UARNDData UPRNDData

attributes	Name	Type	Use	Default	Fixed	annotation
	MID	MessageIdType	required			
	RelatedMID	MessageIdType	optional			
source	<code><xs:element name="T001.0_NewSPIDRequest" type="NewSPIDRequestType"/></code>					

element **MessagesType/T003.0_PartialRegistrationApplications**

diagram	
namespace	urn:bridgeall-com:cmaservice:data:v3
properties	isRef 0 content complex
children	T003.0_PartialRegistrationApplication
source	<code><xs:element name="T003.0_PartialRegistrationApplications"> <xs:complexType> <xs:sequence maxOccurs="unbounded"> <xs:element name="T003.0_PartialRegistrationApplication" type="PartialRegistrationApplicationType"/> </xs:sequence> </xs:complexType> </xs:element></code>

element **MessagesType/T003.0_PartialRegistrationApplications/T003.0_PartialRegistrationApplication**

diagram																			
namespace	urn:bridgeall-com:cmaservice:data:v3																		
type	PartialRegistrationApplicationType																		
properties	isRef 0 content complex																		
children	D2001_SPID																		
attributes	<table border="1"> <tr> <td>Name</td> <td>Type</td> <td>Use</td> <td>Default</td> <td>Fixed</td> <td>annotation</td> </tr> <tr> <td>MID</td> <td>MessageIdType</td> <td>required</td> <td></td> <td></td> <td></td> </tr> <tr> <td>RelatedMID</td> <td>MessageIdType</td> <td>optional</td> <td></td> <td></td> <td></td> </tr> </table>	Name	Type	Use	Default	Fixed	annotation	MID	MessageIdType	required				RelatedMID	MessageIdType	optional			
Name	Type	Use	Default	Fixed	annotation														
MID	MessageIdType	required																	
RelatedMID	MessageIdType	optional																	
source	<code><xs:element name="T003.0_PartialRegistrationApplication" type="PartialRegistrationApplicationType"/></code>																		

element **MessagesType/T003.1_RegistrationApplications**

diagram	
namespace	urn:bridgeall-com:cmaservice:data:v3
properties	isRef 0 content complex
children	T003.1_RegistrationApplication
source	<pre><xs:element name="T003.1_RegistrationApplications"> <xs:complexType> <xs:sequence maxOccurs="unbounded"> <xs:element name="T003.1_RegistrationApplication" type="T003.1_RegistrationApplicationType"/> </xs:sequence> </xs:complexType> </xs:element></pre>

element
MessagesType/T003.1_RegistrationApplications/T003.1_RegistrationApplication

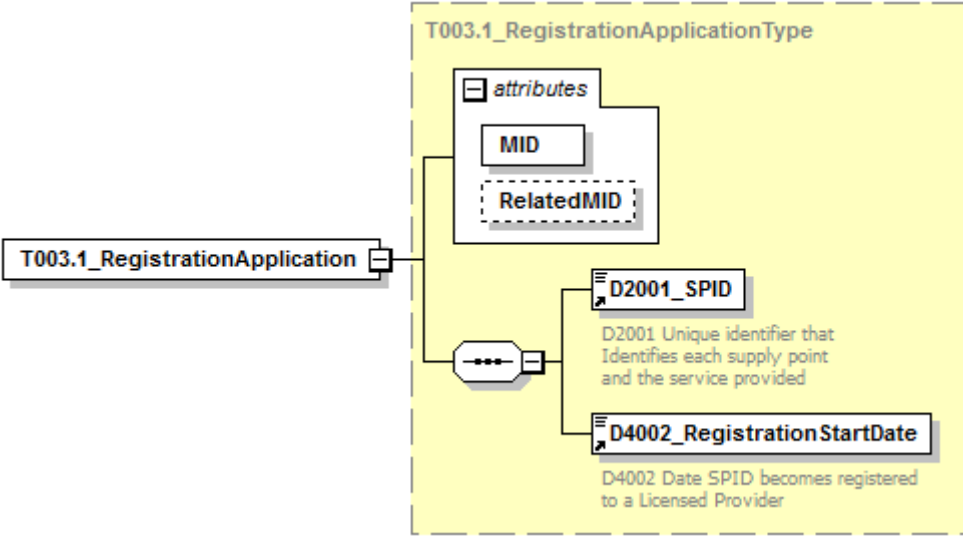
diagram																			
namespace	urn:bridgeall-com:cmaservice:data:v3																		
type	T003.1_RegistrationApplicationType																		
properties	isRef 0 content complex																		
children	D2001_SPID D4002_RegistrationStartDate																		
attributes	<table border="1"> <thead> <tr> <th>Name</th> <th>Type</th> <th>Use</th> <th>Default</th> <th>Fixed</th> <th>annotation</th> </tr> </thead> <tbody> <tr> <td>MID</td> <td>MessageIdType</td> <td>required</td> <td></td> <td></td> <td></td> </tr> <tr> <td>RelatedMID</td> <td>MessageIdType</td> <td>optional</td> <td></td> <td></td> <td></td> </tr> </tbody> </table>	Name	Type	Use	Default	Fixed	annotation	MID	MessageIdType	required				RelatedMID	MessageIdType	optional			
Name	Type	Use	Default	Fixed	annotation														
MID	MessageIdType	required																	
RelatedMID	MessageIdType	optional																	
source	<pre><xs:element name="T003.1_RegistrationApplication" type="T003.1_RegistrationApplicationType"/></pre>																		

element **MessagesType/T004.0_NewMeters**

diagram	
namespace	urn:bridgeall-com:cmaservice:data:v3
properties	isRef 0 content complex
children	T004.0_NewMeter
source	<pre> <xs:element name="T004.0_NewMeters"> <xs:complexType> <xs:sequence maxOccurs="unbounded"> <xs:element name="T004.0_NewMeter" type="T004.0_NewMeterType"/> </xs:sequence> </xs:complexType> </xs:element> </pre>

element **MessageType/T004.0_NewMeters/T004.0_NewMeter**

<p>diagram</p>	<p>T004.0_NewMeterType</p> <ul style="list-style-type: none"> attributes <ul style="list-style-type: none"> MID RelatedMID D2001_SPID: D2001 Unique identifier that identifies each supply point and the service provided D3001_MeterId: Meter Identification (e.g. manufacturers serial number) D3004_NrDigits: The number of digits on the meter register MeterLocation D3003_PhysicalMeterSize: Actual size of a meter (mm) D3002_ChargeableMeterSize: Meter size for tariff charge calculation purposes (mm) D3005_SewerageChargeableMet...: The chargeable size for the Related Water Supply Meter for calculations of Sewerage tariff D3011_MeterReadFrequency: The frequency that the LP must read a meter D3007_ReturnToSewerAllowance: Return to sewer allowance for a particular meter D3013_MeterMake: Meter Make D3014_ManufacturerMeterSerial...: Meter Serial Number D3015_datalogger_SW: Specifies the presence of a Scottish Water datalogger D3016_datalogger_NonSW: Specifies the presence of a non Scottish Water datalogger D3017_GISX: Specifies the X coordinate of the location of the meter D3018_GISY: Specifies the Y coordinate of the location of the meter D3019_GISZFreeDescriptor: Specifies the Z Free Descriptor of the location of the meter D3022_MeterTreatment: Meter Treatment Indicator D3023_AccreditedEntityInstall: Accredited Entity Install - Allows Scottish Water to notify the CMA when an operation has been carried out by an accredited installer D3025_MeterLocationCode: Meter Location Code
<p>namespace</p>	<p>urn:bridgeall-com:cmaservice:data:v3</p>
<p>type</p>	<p>T004.0_NewMeterType</p>

properties	isRef 0 content complex																		
children	D2001_SPID D3001_MeterId D3004_NrDigits MeterLocation D3003_PhysicalMeterSize D3002_ChargeableMeterSize D3005_SewerageChargeableMeterSize D3011_MeterReadFrequency D3007_ReturnToSewerAllowance D3013_MeterMake D3014_ManufacturerMeterSerialNr D3015_datalogger_SW D3016_datalogger_NonSW D3017_GISX D3018_GISY D3019_GISZFreeDescriptor D3022_MeterTreatment D3023_AccreditedEntityInstall D3025_MeterLocationCode																		
attributes	<table border="1"> <thead> <tr> <th>Name</th> <th>Type</th> <th>Use</th> <th>Default</th> <th>Fixed</th> <th>annotation</th> </tr> </thead> <tbody> <tr> <td>MID</td> <td>MessageIdType</td> <td>required</td> <td></td> <td></td> <td></td> </tr> <tr> <td>RelatedMID</td> <td>MessageIdType</td> <td>optional</td> <td></td> <td></td> <td></td> </tr> </tbody> </table>	Name	Type	Use	Default	Fixed	annotation	MID	MessageIdType	required				RelatedMID	MessageIdType	optional			
Name	Type	Use	Default	Fixed	annotation														
MID	MessageIdType	required																	
RelatedMID	MessageIdType	optional																	
source	<code><xs:element name="T004.0_NewMeter" type="T004.0_NewMeterType"/></code>																		

element **MessagesType/T004.2_LPMeterUpdates**

diagram	
namespace	urn:bridgeall-com:cmaservice:data:v3
properties	isRef 0 content complex
children	T004.2_LPMeterUpdate
source	<code><xs:element name="T004.2_LPMeterUpdates"> <xs:complexType> <xs:sequence maxOccurs="unbounded"> <xs:element name="T004.2_LPMeterUpdate" type="LPMeterUpdateType"/> </xs:sequence> </xs:complexType> </xs:element></code>

element **MessagesType/T004.2_LPMeterUpdates/T004.2_LPMeterUpdate**

diagram	
namespace	urn:bridgeall-com:cmaservice:data:v3

type	LPMeterUpdateType					
properties	isRef	0	content	complex		
children	D2001_SPID D3001_MeterId D2010_YVe					
attributes	Name	Type	Use	Default	Fixed	annotation
	MID	MessageIdType	required			
	RelatedMID	MessageIdType	optional			
source	<code><xs:element name="T004.2_LPMeterUpdate" type="LPMeterUpdateType"/></code>					

element [MessagesType/T004.3_VirtualMeters](#)

diagram	
namespace	urn:bridgeall-com:cmaservice:data:v3
properties	isRef 0 content complex
children	T004.3_VirtualMeter
source	<code><xs:element name="T004.3_VirtualMeters"> <xs:complexType> <xs:sequence maxOccurs="unbounded"> <xs:element name="T004.3_VirtualMeter" type="T004.3_VirtualMeterType"/> </xs:sequence> </xs:complexType> </xs:element></code>

element **MessageType/T004.3_VirtualMeters/T004.3_VirtualMeter**

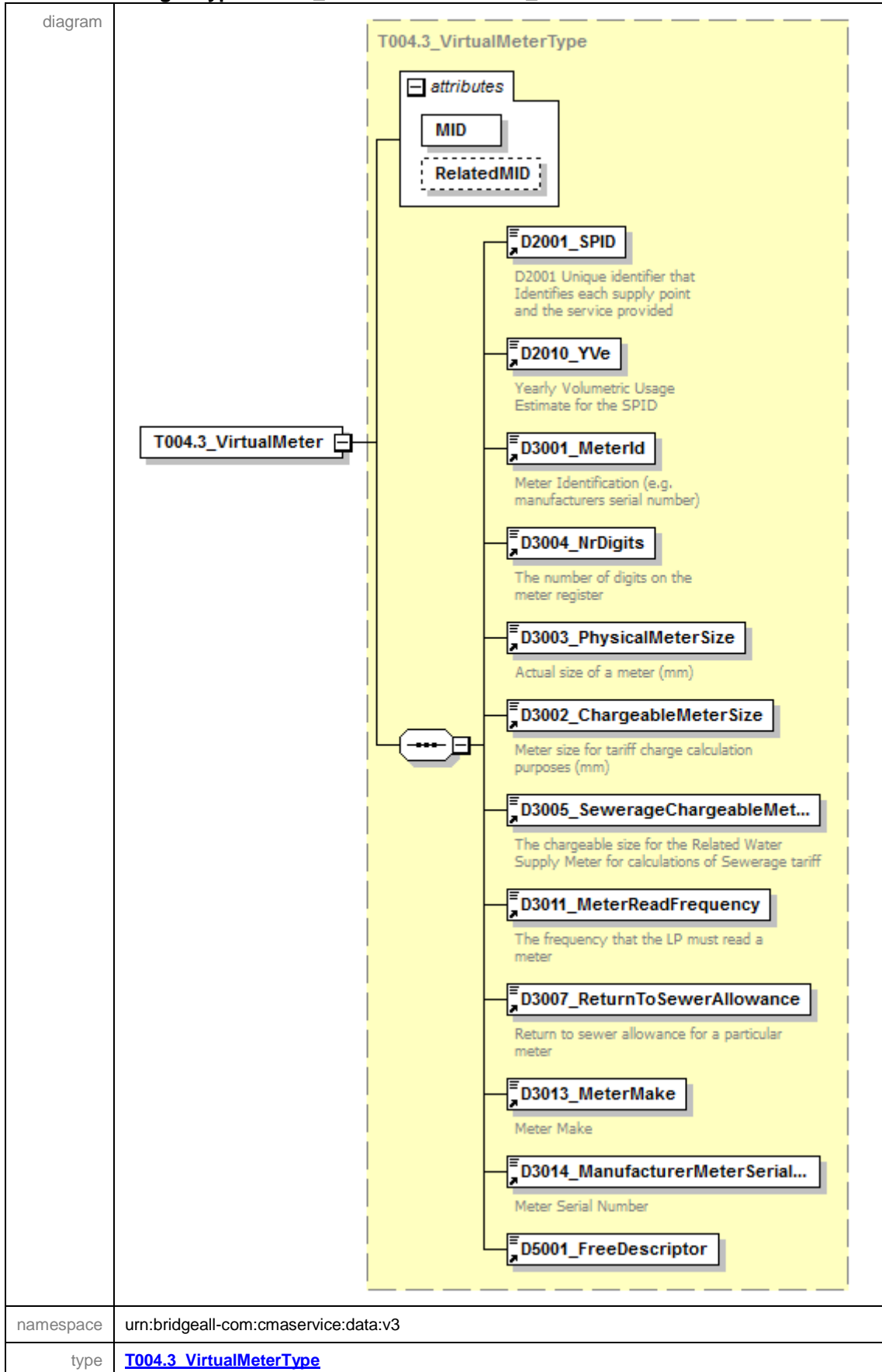

properties	isRef 0 content complex																		
children	D2001_SPID D2010_YVe D3001_MeterId D3004_NrDigits D3003_PhysicalMeterSize D3002_ChargeableMeterSize D3005_SewerageChargeableMeterSize D3011_MeterReadFrequency D3007_ReturnToSewerAllowance D3013_MeterMake D3014_ManufacturerMeterSerialNr D5001_FreeDescriptor																		
attributes	<table border="1"> <thead> <tr> <th>Name</th> <th>Type</th> <th>Use</th> <th>Default</th> <th>Fixed</th> <th>annotation</th> </tr> </thead> <tbody> <tr> <td>MID</td> <td>MessageIdType</td> <td>required</td> <td></td> <td></td> <td></td> </tr> <tr> <td>RelatedMID</td> <td>MessageIdType</td> <td>optional</td> <td></td> <td></td> <td></td> </tr> </tbody> </table>	Name	Type	Use	Default	Fixed	annotation	MID	MessageIdType	required				RelatedMID	MessageIdType	optional			
Name	Type	Use	Default	Fixed	annotation														
MID	MessageIdType	required																	
RelatedMID	MessageIdType	optional																	
source	<code><xs:element name="T004.3_VirtualMeter" type="T004.3_VirtualMeterType"/></code>																		

element **MessagesType/T005.0_SWMeterReads**

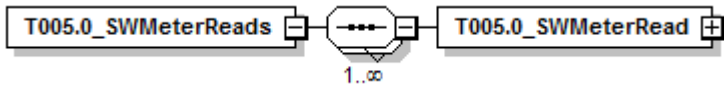
diagram	
namespace	urn:bridgeall-com:cmaservice:data:v3
properties	isRef 0 content complex
children	T005.0_SWMeterRead
source	<code><xs:element name="T005.0_SWMeterReads"> <xs:complexType> <xs:sequence maxOccurs="unbounded"> <xs:element name="T005.0_SWMeterRead" type="MeterReadType"/> </xs:sequence> </xs:complexType> </xs:element></code>

element **MessagesType/T005.0_SWMeterReads/T005.0_SWMeterRead**

<p>diagram</p>																			
<p>namespace</p>	<p>urn:bridgeall-com:cmaservice:data:v3</p>																		
<p>type</p>	<p>MeterReadType</p>																		
<p>properties</p>	<p>isRef 0 content complex</p>																		
<p>children</p>	<p>D2001_SPID D3001_MeterId D3008_MeterRead D3009_MeterReadDate D3010_MeterReadType D3028_SReadReasonCode D3029_SReadRemedialWorkIndicator D3012_ReRead D3020_Rollover_Indicator</p>																		
<p>attributes</p>	<table border="1"> <thead> <tr> <th>Name</th> <th>Type</th> <th>Use</th> <th>Default</th> <th>Fixed</th> <th>annotation</th> </tr> </thead> <tbody> <tr> <td>MID</td> <td>MessageIdType</td> <td>required</td> <td></td> <td></td> <td></td> </tr> <tr> <td>RelatedMID</td> <td>MessageIdType</td> <td>optional</td> <td></td> <td></td> <td></td> </tr> </tbody> </table>	Name	Type	Use	Default	Fixed	annotation	MID	MessageIdType	required				RelatedMID	MessageIdType	optional			
Name	Type	Use	Default	Fixed	annotation														
MID	MessageIdType	required																	
RelatedMID	MessageIdType	optional																	
<p>source</p>	<p><xs:element name="T005.0_SWMeterRead" type="MeterReadType"/></p>																		

element **MessagesType/T005.1_LPMeterReads**

diagram	
namespace	urn:bridgeall-com:cmaservice:data:v3
properties	isRef 0 content complex
children	T005.1_LPMeterRead
source	<pre> <xs:element name="T005.1_LPMeterReads"> <xs:complexType> <xs:sequence maxOccurs="unbounded"> <xs:element name="T005.1_LPMeterRead" type="MeterReadType"/> </xs:sequence> </xs:complexType> </xs:element> </pre>

element **MessagesType/T005.1_LPMeterReads/T005.1_LPMeterRead**

<p>diagram</p>																			
<p>namespace</p>	<p>urn:bridgeall-com:cmaservice:data:v3</p>																		
<p>type</p>	<p>MeterReadType</p>																		
<p>properties</p>	<p>isRef 0 content complex</p>																		
<p>children</p>	<p>D2001_SPID D3001_MeterId D3008_MeterRead D3009_MeterReadDate D3010_MeterReadType D3028_SReadReasonCode D3029_SReadRemedialWorkIndicator D3012_ReRead D3020_Rollover_Indicator</p>																		
<p>attributes</p>	<table border="1"> <thead> <tr> <th>Name</th> <th>Type</th> <th>Use</th> <th>Default</th> <th>Fixed</th> <th>annotation</th> </tr> </thead> <tbody> <tr> <td>MID</td> <td>MessageIdType</td> <td>required</td> <td></td> <td></td> <td></td> </tr> <tr> <td>RelatedMID</td> <td>MessageIdType</td> <td>optional</td> <td></td> <td></td> <td></td> </tr> </tbody> </table>	Name	Type	Use	Default	Fixed	annotation	MID	MessageIdType	required				RelatedMID	MessageIdType	optional			
Name	Type	Use	Default	Fixed	annotation														
MID	MessageIdType	required																	
RelatedMID	MessageIdType	optional																	
<p>source</p>	<p><xs:element name="T005.1_LPMeterRead" type="MeterReadType"/></p>																		

element **MessagesType/T006.0_LPWaterSPIDUpdates**

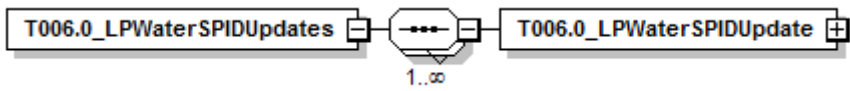
diagram	
namespace	urn:bridgeall-com:cmaservice:data:v3
properties	isRef 0 content complex
children	T006.0_LPWaterSPIDUpdate
source	<pre><xs:element name="T006.0_LPWaterSPIDUpdates"> <xs:complexType> <xs:sequence maxOccurs="unbounded"> <xs:element name="T006.0_LPWaterSPIDUpdate" type="T006.0_LPWaterSPIDUpdateType"/> </xs:sequence> </xs:complexType> </xs:element></pre>

element **MessagesType/T006.0_LPWaterSPIDUpdates/T006.0_LPWaterSPIDUpdate**

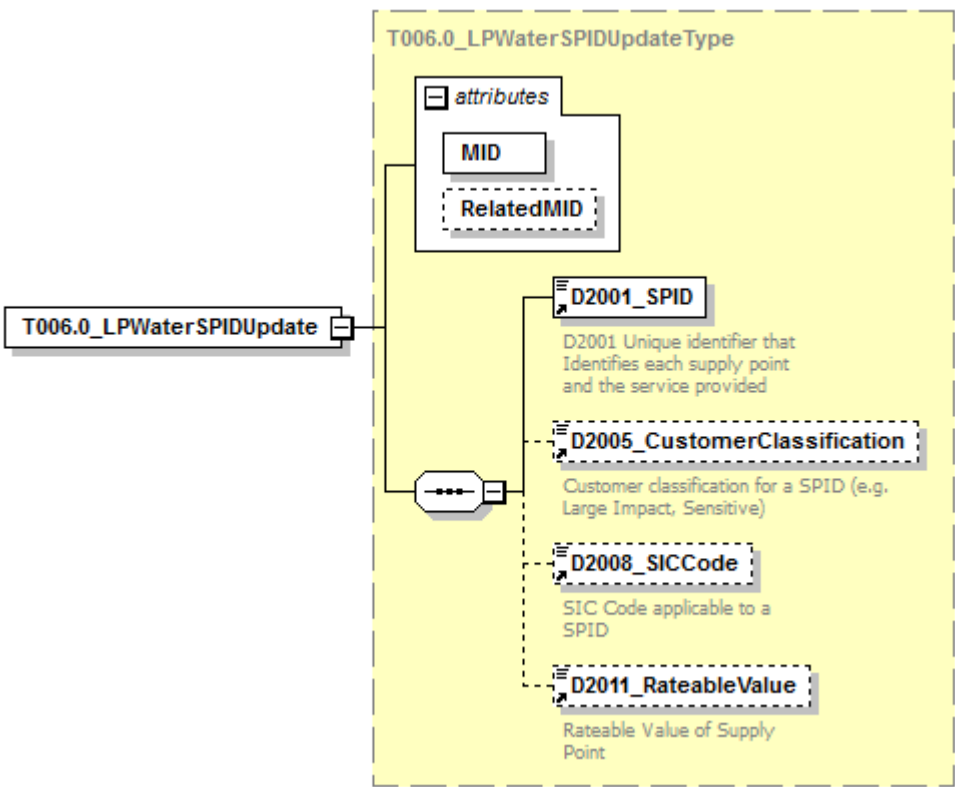
diagram													
namespace	urn:bridgeall-com:cmaservice:data:v3												
type	T006.0_LPWaterSPIDUpdateType												
properties	isRef 0 content complex												
children	D2001_SPID D2005_CustomerClassification D2008_SICCode D2011_RateableValue												
attributes	<table border="1"> <thead> <tr> <th>Name</th> <th>Type</th> <th>Use</th> <th>Default</th> <th>Fixed</th> <th>annotation</th> </tr> </thead> <tbody> <tr> <td>MID</td> <td>MessageIdType</td> <td>required</td> <td></td> <td></td> <td></td> </tr> </tbody> </table>	Name	Type	Use	Default	Fixed	annotation	MID	MessageIdType	required			
Name	Type	Use	Default	Fixed	annotation								
MID	MessageIdType	required											

	RelatedMID MessageIdType optional
source	<code><xs:element name="T006.0_LPWaterSPIDUpdate" type="T006.0_LPWaterSPIDUpdateType"/></code>

element **MessagesType/T006.1_LPSewerageSPIDUpdates**

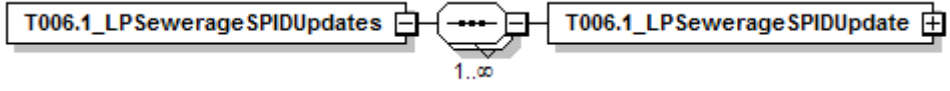
diagram	
namespace	urn:bridgeall-com:cmaservice:data:v3
properties	isRef 0 content complex
children	T006.1_LP_Sewerage_SPIDUpdate
source	<code><xs:element name="T006.1_LP_Sewerage_SPIDUpdates"> <xs:complexType> <xs:sequence maxOccurs="unbounded"> <xs:element name="T006.1_LP_Sewerage_SPIDUpdate" type="T006.1_LP_Sewerage_SPIDUpdateType"/> </xs:sequence> </xs:complexType> </xs:element></code>

element **MessagesType/T006.1_LPSewerageSPIDUpdates/T006.1_LP_Sewerage_SPIDUpdate**

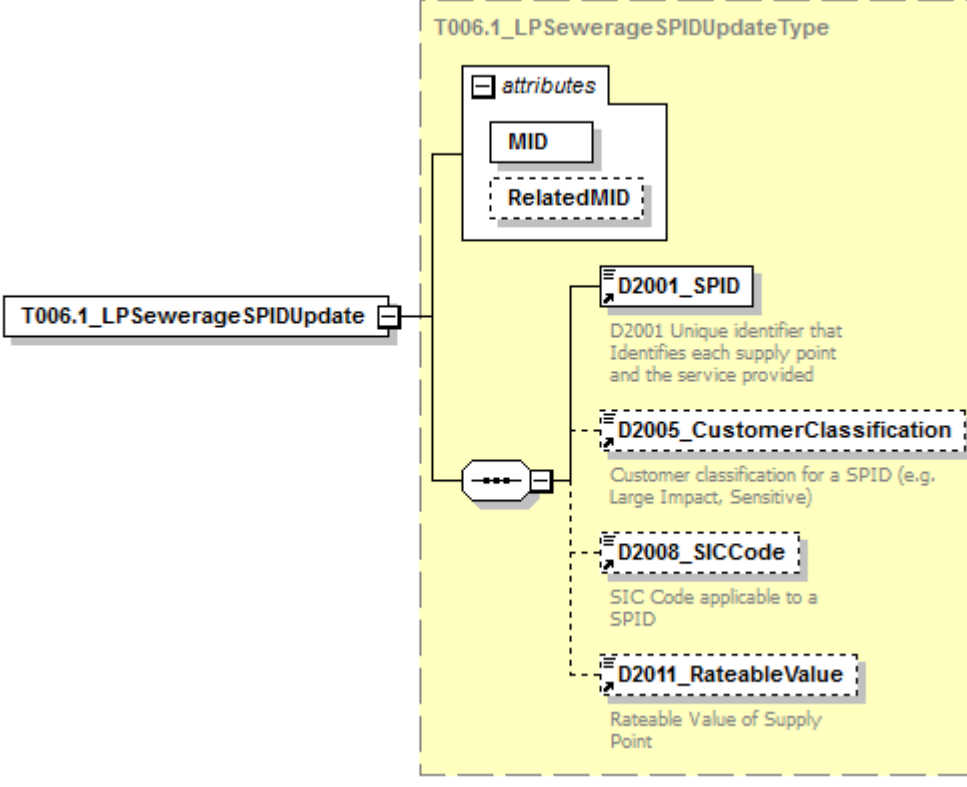
diagram	
namespace	urn:bridgeall-com:cmaservice:data:v3

type	T006.1_LPSewerageSPIDUpdateType					
properties	isRef	0	content	complex		
children	D2001_SPID D2005_CustomerClassification D2008_SICCode D2011_RateableValue					
attributes	Name	Type	Use	Default	Fixed	annotation
	MID	MessageIdType	required			
	RelatedMID	MessageIdType	optional			
source	<pre><xs:element name="T006.1_LPSewerageSPIDUpdate" type="T006.1_LPSewerageSPIDUpdateType"/></pre>					

element **MessagesType/T006.2_WaterSPIDUpdates**

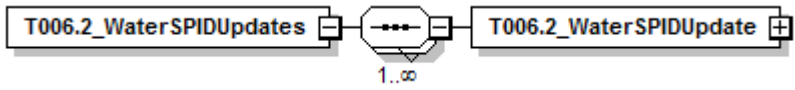
diagram	
namespace	urn:bridgeall-com:cmaservice:data:v3
properties	isRef 0 content complex
children	T006.2_WaterSPIDUpdate
source	<pre><xs:element name="T006.2_WaterSPIDUpdates"> <xs:complexType> <xs:sequence maxOccurs="unbounded"> <xs:element name="T006.2_WaterSPIDUpdate" type="T006.2_WaterSPIDUpdateType"/> </xs:sequence> </xs:complexType> </xs:element></pre>

element **MessagesType/T006.2_WaterSPIDUpdates/T006.2_WaterSPIDUpdate**

diagram																			
namespace	urn:bridgeall-com:cmaservice:data:v3																		
type	T006.2_WaterSPIDUpdateType																		
properties	isRef 0 content complex																		
children	D2001_SPID D2018_TroughsDrinkingBowls D2020_OutsideTaps D2014_FarmCroft																		
attributes	<table border="1"> <thead> <tr> <th>Name</th> <th>Type</th> <th>Use</th> <th>Default</th> <th>Fixed</th> <th>annotation</th> </tr> </thead> <tbody> <tr> <td>MID</td> <td>MessageIdType</td> <td>required</td> <td></td> <td></td> <td></td> </tr> <tr> <td>RelatedMID</td> <td>MessageIdType</td> <td>optional</td> <td></td> <td></td> <td></td> </tr> </tbody> </table>	Name	Type	Use	Default	Fixed	annotation	MID	MessageIdType	required				RelatedMID	MessageIdType	optional			
Name	Type	Use	Default	Fixed	annotation														
MID	MessageIdType	required																	
RelatedMID	MessageIdType	optional																	
source	<pre><xs:element name="T006.2_WaterSPIDUpdate" type="T006.2_WaterSPIDUpdateType"/></pre>																		

element **MessagesType/T006.3_SewerageSPIDUpdates**

diagram	
namespace	urn:bridgeall-com:cmaservice:data:v3
properties	isRef 0 content complex
children	T006.3_SewerageSPIDUpdate
source	<pre><xs:element name="T006.3_SewerageSPIDUpdates"> <xs:complexType> <xs:sequence maxOccurs="unbounded"> <xs:element name="T006.3_SewerageSPIDUpdate" type="T006.3_SewerageSPIDUpdateType"/> </xs:sequence> </xs:complexType> </xs:element></pre>

	<pre> </xs:sequence> </xs:complexType> </xs:element> </pre>
--	---

element **MessagesType/T006.3_SewerageSPIDUpdates/T006.3_SewerageSPIDUpdate**

diagram																			
namespace	urn:bridgeall-com:cmaservice:data:v3																		
type	T006.3_SewerageSPIDUpdateType																		
properties	isRef 0 content complex																		
children	D2001_SPID D2016_PropertyDrainage D2017_RoadDrainage																		
attributes	<table border="1"> <thead> <tr> <th>Name</th> <th>Type</th> <th>Use</th> <th>Default</th> <th>Fixed</th> <th>annotation</th> </tr> </thead> <tbody> <tr> <td>MID</td> <td>MessageIdType</td> <td>required</td> <td></td> <td></td> <td></td> </tr> <tr> <td>RelatedMID</td> <td>MessageIdType</td> <td>optional</td> <td></td> <td></td> <td></td> </tr> </tbody> </table>	Name	Type	Use	Default	Fixed	annotation	MID	MessageIdType	required				RelatedMID	MessageIdType	optional			
Name	Type	Use	Default	Fixed	annotation														
MID	MessageIdType	required																	
RelatedMID	MessageIdType	optional																	
source	<pre> <xs:element name="T006.3_SewerageSPIDUpdate" type="T006.3_SewerageSPIDUpdateType"/> </pre>																		

element **MessagesType/T007.0_WaterConnectionCompletes**

diagram	
namespace	urn:bridgeall-com:cmaservice:data:v3
properties	isRef 0 content complex
children	T007.0_WaterConnectionComplete
source	<pre> <xs:element name="T007.0_WaterConnectionCompletes"> <xs:complexType> <xs:sequence maxOccurs="unbounded"> <xs:element name="T007.0_WaterConnectionComplete" type="T007.0_WaterConnectionCompleteType"/> </pre>

```

</xs:sequence>
</xs:complexType>
</xs:element>

```

element

MessageType/T007.0_WaterConnectionCompletes/T007.0_WaterConnectionComplete

diagram	<p>The diagram illustrates the structure of the T007.0_WaterConnectionCompleteType. It is a sequence of elements: <ul style="list-style-type: none"> MID: A required element of type MessageIdType. RelatedMID: An optional element of type MessageIdType. A complex type containing: <ul style="list-style-type: none"> D2001_SPID: A required element of type MessageIdType. Description: D2001 Unique identifier that Identifies each supply point and the service provided. D2013_ConnectionDate: A required element of type MessageIdType. Description: Date the connection was completed. D2033_AccreditedEntityInstall: An optional element of type MessageIdType. Description: Accredited Entity Install - Allows Scottish Water to notify the CMA when an operation has been carried out by an accredited installer. </p>																		
namespace	urn:bridgeall-com:cmaservice:data:v3																		
type	T007.0_WaterConnectionCompleteType																		
properties	isRef 0 content complex																		
children	D2001_SPID D2013_ConnectionDate D2033_AccreditedEntityInstall																		
attributes	<table border="1"> <thead> <tr> <th>Name</th> <th>Type</th> <th>Use</th> <th>Default</th> <th>Fixed</th> <th>annotation</th> </tr> </thead> <tbody> <tr> <td>MID</td> <td>MessageIdType</td> <td>required</td> <td></td> <td></td> <td></td> </tr> <tr> <td>RelatedMID</td> <td>MessageIdType</td> <td>optional</td> <td></td> <td></td> <td></td> </tr> </tbody> </table>	Name	Type	Use	Default	Fixed	annotation	MID	MessageIdType	required				RelatedMID	MessageIdType	optional			
Name	Type	Use	Default	Fixed	annotation														
MID	MessageIdType	required																	
RelatedMID	MessageIdType	optional																	
source	<code><xs:element name="T007.0_WaterConnectionComplete" type="T007.0_WaterConnectionCompleteType"/></code>																		

element MessageType/T007.1_SewerageConnectionCompletes

diagram	<p>The diagram illustrates the structure of the T007.1_SewerageConnectionCompletes element. It is a sequence of elements: <ul style="list-style-type: none"> T007.1_SewerageConnectionComplete: A required element. T007.1_SewerageConnectionComplete: An optional element, repeated 1 to infinity times (1..∞). </p>
namespace	urn:bridgeall-com:cmaservice:data:v3
properties	isRef 0 content complex
children	T007.1_SewerageConnectionComplete
source	<code><xs:element name="T007.1_SewerageConnectionCompletes"></code>

	<pre> <xs:complexType> <xs:sequence maxOccurs="unbounded"> <xs:element name="T007.1_SewerageConnectionComplete" type="ConnectionCompleteType"/> </xs:sequence> </xs:complexType> </xs:element> </pre>
--	---

element

**MessagesType/T007.1_SewerageConnectionCompletes/T007.1_SewerageConnectionC
omplete**

diagram																			
namespace	urn:bridgeall-com:cmaservice:data:v3																		
type	ConnectionCompleteType																		
properties	isRef 0 content complex																		
children	D2001_SPID D2013_ConnectionDate																		
attributes	<table border="1"> <thead> <tr> <th>Name</th> <th>Type</th> <th>Use</th> <th>Default</th> <th>Fixed</th> <th>annotation</th> </tr> </thead> <tbody> <tr> <td>MID</td> <td>MessageIdType</td> <td>required</td> <td></td> <td></td> <td></td> </tr> <tr> <td>RelatedMID</td> <td>MessageIdType</td> <td>optional</td> <td></td> <td></td> <td></td> </tr> </tbody> </table>	Name	Type	Use	Default	Fixed	annotation	MID	MessageIdType	required				RelatedMID	MessageIdType	optional			
Name	Type	Use	Default	Fixed	annotation														
MID	MessageIdType	required																	
RelatedMID	MessageIdType	optional																	
source	<pre> <xs:element name="T007.1_SewerageConnectionComplete" type="ConnectionCompleteType"/> </pre>																		

element MessagesType/T009.2_Notifications

diagram	
namespace	urn:bridgeall-com:cmaservice:data:v3
properties	isRef 0 content complex
children	T009.2_Notification
source	<pre> <xs:element name="T009.2_Notifications"> <xs:complexType> <xs:sequence maxOccurs="unbounded"> </pre>

```

<xs:element name="T009.2_Notification" type="NotificationType"/>
</xs:sequence>
</xs:complexType>
</xs:element>

```

element MessagesType/T009.2_Notifications/T009.2_Notification

diagram																			
namespace	urn:bridgeall-com:cmaservice:data:v3																		
type	NotificationType																		
properties	isRef 0 content complex																		
children	D1008_DataItemRef D4004_ReturnCode D2001_SPID																		
attributes	<table border="1"> <thead> <tr> <th>Name</th> <th>Type</th> <th>Use</th> <th>Default</th> <th>Fixed</th> <th>annotation</th> </tr> </thead> <tbody> <tr> <td>MID</td> <td>MessageIdType</td> <td>required</td> <td></td> <td></td> <td></td> </tr> <tr> <td>RelatedMID</td> <td>MessageIdType</td> <td>optional</td> <td></td> <td></td> <td></td> </tr> </tbody> </table>	Name	Type	Use	Default	Fixed	annotation	MID	MessageIdType	required				RelatedMID	MessageIdType	optional			
Name	Type	Use	Default	Fixed	annotation														
MID	MessageIdType	required																	
RelatedMID	MessageIdType	optional																	
source	<pre><xs:element name="T009.2_Notification" type="NotificationType"/></pre>																		

element MessagesType/T009.3_Notifications

diagram	
namespace	urn:bridgeall-com:cmaservice:data:v3
properties	isRef 0 content complex
children	T009.3_Notification
source	<pre> <xs:element name="T009.3_Notifications"> <xs:complexType> <xs:sequence maxOccurs="unbounded"> <xs:element name="T009.3_Notification" type="NotificationType"/> </xs:sequence> </xs:complexType> </pre>

</xs:element>

element **MessagesType/T009.3_Notifications/T009.3_Notification**

diagram																			
namespace	urn:bridgeall-com:cmaservice:data:v3																		
type	NotificationType																		
properties	isRef 0 content complex																		
children	D1008_DataItemRef D4004_ReturnCode D2001_SPID																		
attributes	<table border="1"> <thead> <tr> <th>Name</th> <th>Type</th> <th>Use</th> <th>Default</th> <th>Fixed</th> <th>annotation</th> </tr> </thead> <tbody> <tr> <td>MID</td> <td>MessageIdType</td> <td>required</td> <td></td> <td></td> <td></td> </tr> <tr> <td>RelatedMID</td> <td>MessageIdType</td> <td>optional</td> <td></td> <td></td> <td></td> </tr> </tbody> </table>	Name	Type	Use	Default	Fixed	annotation	MID	MessageIdType	required				RelatedMID	MessageIdType	optional			
Name	Type	Use	Default	Fixed	annotation														
MID	MessageIdType	required																	
RelatedMID	MessageIdType	optional																	
source	<code><xs:element name="T009.3_Notification" type="NotificationType"/></code>																		

element **MessagesType/T010.0_CancelRegistrations**

diagram	
namespace	urn:bridgeall-com:cmaservice:data:v3
properties	isRef 0 content complex
children	T010.0_CancelRegistration
source	<pre> <xs:element name="T010.0_CancelRegistrations"> <xs:complexType> <xs:sequence maxOccurs="unbounded"> <xs:element name="T010.0_CancelRegistration" type="CancelRegistrationType"/> </xs:sequence> </xs:complexType> </xs:element> </pre>

element **MessagesType/T010.0_CancelRegistrations/T010.0_CancelRegistration**

diagram																			
namespace	urn:bridgeall-com:cmaservice:data:v3																		
type	CancelRegistrationType																		
properties	isRef 0 content complex																		
children	D2001_SPID D4005_CancellationCode																		
attributes	<table border="1"> <thead> <tr> <th>Name</th> <th>Type</th> <th>Use</th> <th>Default</th> <th>Fixed</th> <th>annotation</th> </tr> </thead> <tbody> <tr> <td>MID</td> <td>MessageIdType</td> <td>required</td> <td></td> <td></td> <td></td> </tr> <tr> <td>RelatedMID</td> <td>MessageIdType</td> <td>optional</td> <td></td> <td></td> <td></td> </tr> </tbody> </table>	Name	Type	Use	Default	Fixed	annotation	MID	MessageIdType	required				RelatedMID	MessageIdType	optional			
Name	Type	Use	Default	Fixed	annotation														
MID	MessageIdType	required																	
RelatedMID	MessageIdType	optional																	
source	<code><xs:element name="T010.0_CancelRegistration" type="CancelRegistrationType"/></code>																		

element **MessagesType/T010.1_CancelRegistrations**

diagram	
namespace	urn:bridgeall-com:cmaservice:data:v3
properties	isRef 0 content complex
children	T010.1_CancelRegistration
source	<pre> <xs:element name="T010.1_CancelRegistrations"> <xs:complexType> <xs:sequence maxOccurs="unbounded"> <xs:element name="T010.1_CancelRegistration" type="CancelRegistrationOutType"/> </xs:sequence> </xs:complexType> </xs:element> </pre>

element **MessagesType/T010.1_CancelRegistrations/T010.1_CancelRegistration**

diagram																			
namespace	urn:bridgeall-com:cmaservice:data:v3																		
type	CancelRegistrationOutType																		
properties	isRef 0 content complex																		
children	D2001_SPID D4005_CancellationCode D4003_Comment																		
attributes	<table border="1"> <thead> <tr> <th>Name</th> <th>Type</th> <th>Use</th> <th>Default</th> <th>Fixed</th> <th>annotation</th> </tr> </thead> <tbody> <tr> <td>MID</td> <td>MessageIdType</td> <td>required</td> <td></td> <td></td> <td></td> </tr> <tr> <td>RelatedMID</td> <td>MessageIdType</td> <td>optional</td> <td></td> <td></td> <td></td> </tr> </tbody> </table>	Name	Type	Use	Default	Fixed	annotation	MID	MessageIdType	required				RelatedMID	MessageIdType	optional			
Name	Type	Use	Default	Fixed	annotation														
MID	MessageIdType	required																	
RelatedMID	MessageIdType	optional																	
source	<code><xs:element name="T010.1_CancelRegistration" type="CancelRegistrationOutType"/></code>																		

element **MessagesType/T012.0_MiscSPIDUpdates**

diagram	
namespace	urn:bridgeall-com:cmaservice:data:v3
properties	isRef 0 content complex
children	T012.0_MiscSPIDUpdate
source	<pre> <xs:element name="T012.0_MiscSPIDUpdates"> <xs:complexType> <xs:sequence maxOccurs="unbounded"> <xs:element name="T012.0_MiscSPIDUpdate" type="T012.0_MiscSPIDUpdateType"/> </xs:sequence> </xs:complexType> </xs:element> </pre>

element **MessagesType/T012.0_MiscSPIDUpdates/T012.0_MiscSPIDUpdate**

<p>diagram</p>																			
<p>namespace</p>	<p>urn:bridgeall-com:cmaservice:data:v3</p>																		
<p>type</p>	<p>T012.0_MiscSPIDUpdateType</p>																		
<p>properties</p>	<p>isRef 0 content complex</p>																		
<p>children</p>	<p>D2001_SPID Address D2005_CustomerClassification D4003_Comment D4006_EffectiveFrom D2008_SICCode</p>																		
<p>attributes</p>	<table border="1"> <thead> <tr> <th>Name</th> <th>Type</th> <th>Use</th> <th>Default</th> <th>Fixed</th> <th>annotation</th> </tr> </thead> <tbody> <tr> <td>MID</td> <td>MessageIdType</td> <td>required</td> <td></td> <td></td> <td></td> </tr> <tr> <td>RelatedMID</td> <td>MessageIdType</td> <td>optional</td> <td></td> <td></td> <td></td> </tr> </tbody> </table>	Name	Type	Use	Default	Fixed	annotation	MID	MessageIdType	required				RelatedMID	MessageIdType	optional			
Name	Type	Use	Default	Fixed	annotation														
MID	MessageIdType	required																	
RelatedMID	MessageIdType	optional																	
<p>source</p>	<pre><xs:element name="T012.0_MiscSPIDUpdate" type="T012.0_MiscSPIDUpdateType"/></pre>																		

element **MessagesType/T012.1_ServiceElementUpdates**

<p>diagram</p>	
<p>namespace</p>	<p>urn:bridgeall-com:cmaservice:data:v3</p>
<p>properties</p>	<p>isRef 0 content complex</p>
<p>children</p>	<p>T012.1_ServiceElementUpdate</p>

source	<pre> <xs:element name="T012.1_ServiceElementUpdates"> <xs:complexType> <xs:sequence maxOccurs="unbounded"> <xs:element name="T012.1_ServiceElementUpdate" type="T012.1_ServiceElementUpdateType"/> </xs:sequence> </xs:complexType> </xs:element> </pre>
--------	---

element **MessagesType/T012.1_ServiceElementUpdates/T012.1_ServiceElementUpdate**

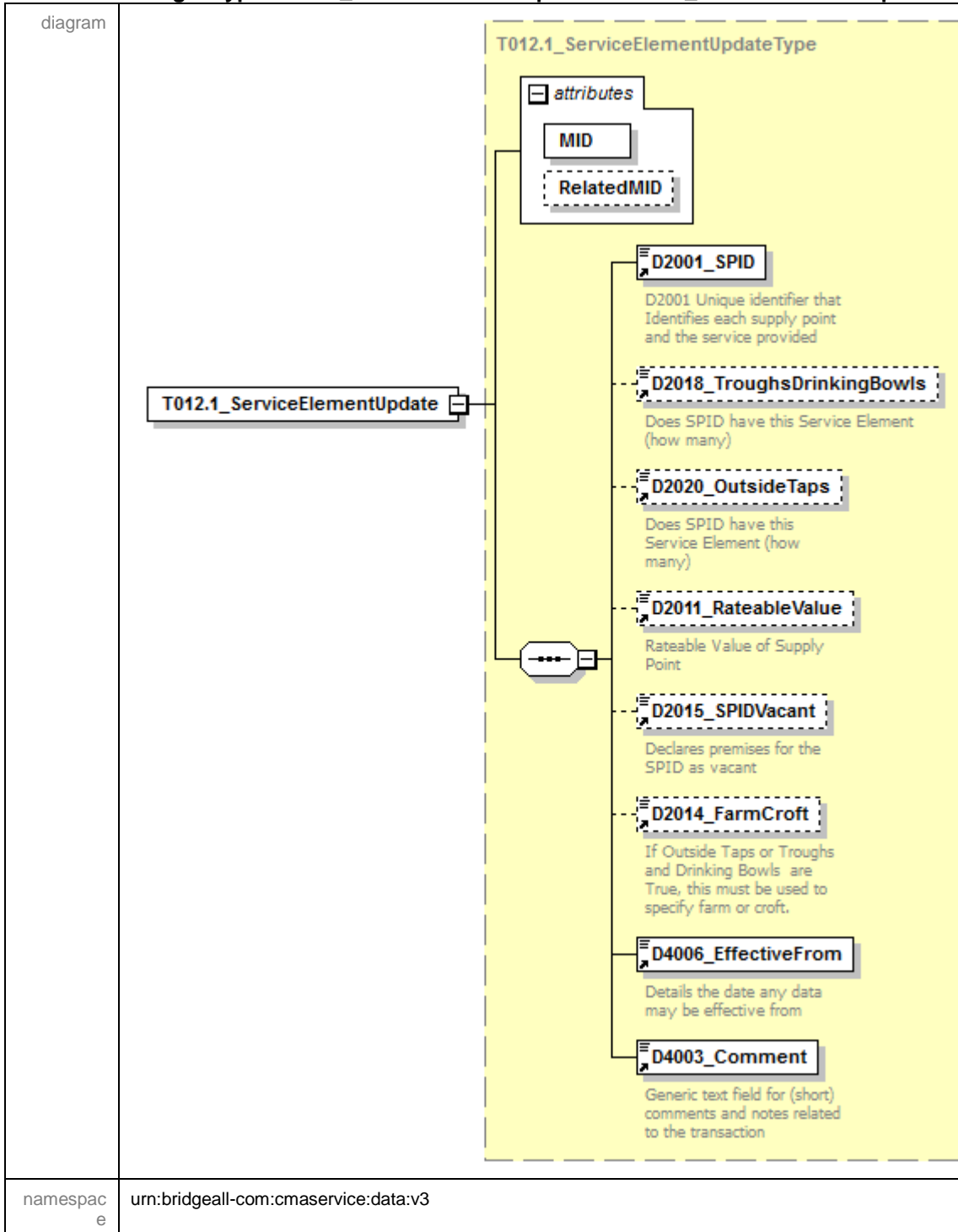

type	T012.1_ServiceElementUpdateType					
properties	isRef	0	content	complex		
children	D2001_SPID D2018_TroughsDrinkingBowls D2020_OutsideTaps D2011_RateableValue D2015_SPIDVacant D2014_FarmCroft D4006_EffectiveFrom D4003_Comment					
attributes	Name	Type	Use	Default	Fixed	annotation
	MID	MessageIdType	required			
	RelatedMID	MessageIdType	optional			
source	<code><xs:element name="T012.1_ServiceElementUpdate" type="T012.1_ServiceElementUpdateType"/></code>					

element **MessagesType/T012.3_SewerageServiceElementUpdates**

diagram	
namespace	urn:bridgeall-com:cmaservice:data:v3
properties	isRef 0 content complex
children	T012.3_SewerageServiceElementUpdate
source	<code><xs:element name="T012.3_SewerageServiceElementUpdates"> <xs:complexType> <xs:sequence maxOccurs="unbounded"> <xs:element name="T012.3_SewerageServiceElementUpdate" type="T012.3_SewerageServiceElementUpdateType"/> </xs:sequence> </xs:complexType> </xs:element></code>

element
MessagesType/T012.3_SewerageServiceElementUpdates/T012.3_SewerageServiceElementUpdate

diagram						
namespace	urn:bridgeall-com:cmaservice:data:v3					
type	T012.3_SewerageServiceElementUpdateType					
properties	isRef	0				
	content	complex				
children	D2001_SPID D4006_EffectiveFrom D2016_PropertyDrainage D2017_RoadDrainage D4003_Comment					
attributes	Name	Type	Use	Default	Fixed	annotation
	MID	MessageIdType	required			
	RelatedMID	MessageIdType	optional			
source	<code><xs:element name="T012.3_SewerageServiceElementUpdate" type="T012.3_SewerageServiceElementUpdateType"/></code>					

element **MessagesType/T012.5_UpdateSAARefereceNumberUPRNs**

diagram						
namespace	urn:bridgeall-com:cmaservice:data:v3					
properties	isRef	0				
	content	complex				

children	T012.5_UpdateSAAReferenceNumberUPRN
source	<pre> <xs:element name="T012.5_UpdateSAAReferenceNumberUPRNs"> <xs:complexType> <xs:sequence maxOccurs="unbounded"> <xs:element name="T012.5_UpdateSAAReferenceNumberUPRN" type="UpdateSAAReferenceNumberUPRNType"/> </xs:sequence> </xs:complexType> </xs:element> </pre>

element

MessagesType/T012.5_UpdateSAAReferenceNumberUPRNs/T012.5_UpdateSAAReferenceNumberUPRN

diagram																			
namespace	urn:bridgeall-com:cmaservice:data:v3																		
type	UpdateSAAReferenceNumberUPRNType																		
properties	isRef 0 content complex																		
children	D2001_SPID UARNDData UPRNDData																		
attributes	<table border="1"> <thead> <tr> <th>Name</th> <th>Type</th> <th>Use</th> <th>Default</th> <th>Fixed</th> <th>annotation</th> </tr> </thead> <tbody> <tr> <td>MID</td> <td>MessageIdType</td> <td>required</td> <td></td> <td></td> <td></td> </tr> <tr> <td>RelatedMID</td> <td>MessageIdType</td> <td>optional</td> <td></td> <td></td> <td></td> </tr> </tbody> </table>	Name	Type	Use	Default	Fixed	annotation	MID	MessageIdType	required				RelatedMID	MessageIdType	optional			
Name	Type	Use	Default	Fixed	annotation														
MID	MessageIdType	required																	
RelatedMID	MessageIdType	optional																	
source	<pre> <xs:element name="T012.5_UpdateSAAReferenceNumberUPRN" type="UpdateSAAReferenceNumberUPRNType"/> </pre>																		

element MessagesType/T013.0_MeterUpdates

diagram	
namespace	urn:bridgeall-com:cmaservice:data:v3
properties	isRef 0 content complex
children	T013.0_MeterUpdate

source	<pre><xs:element name="T013.0_MeterUpdates"> <xs:complexType> <xs:sequence maxOccurs="unbounded"> <xs:element name="T013.0_MeterUpdate" type="MeterUpdateType"/> </xs:sequence> </xs:complexType> </xs:element></pre>
--------	---

element **MessageType/T013.0_MeterUpdates/T013.0_MeterUpdate**

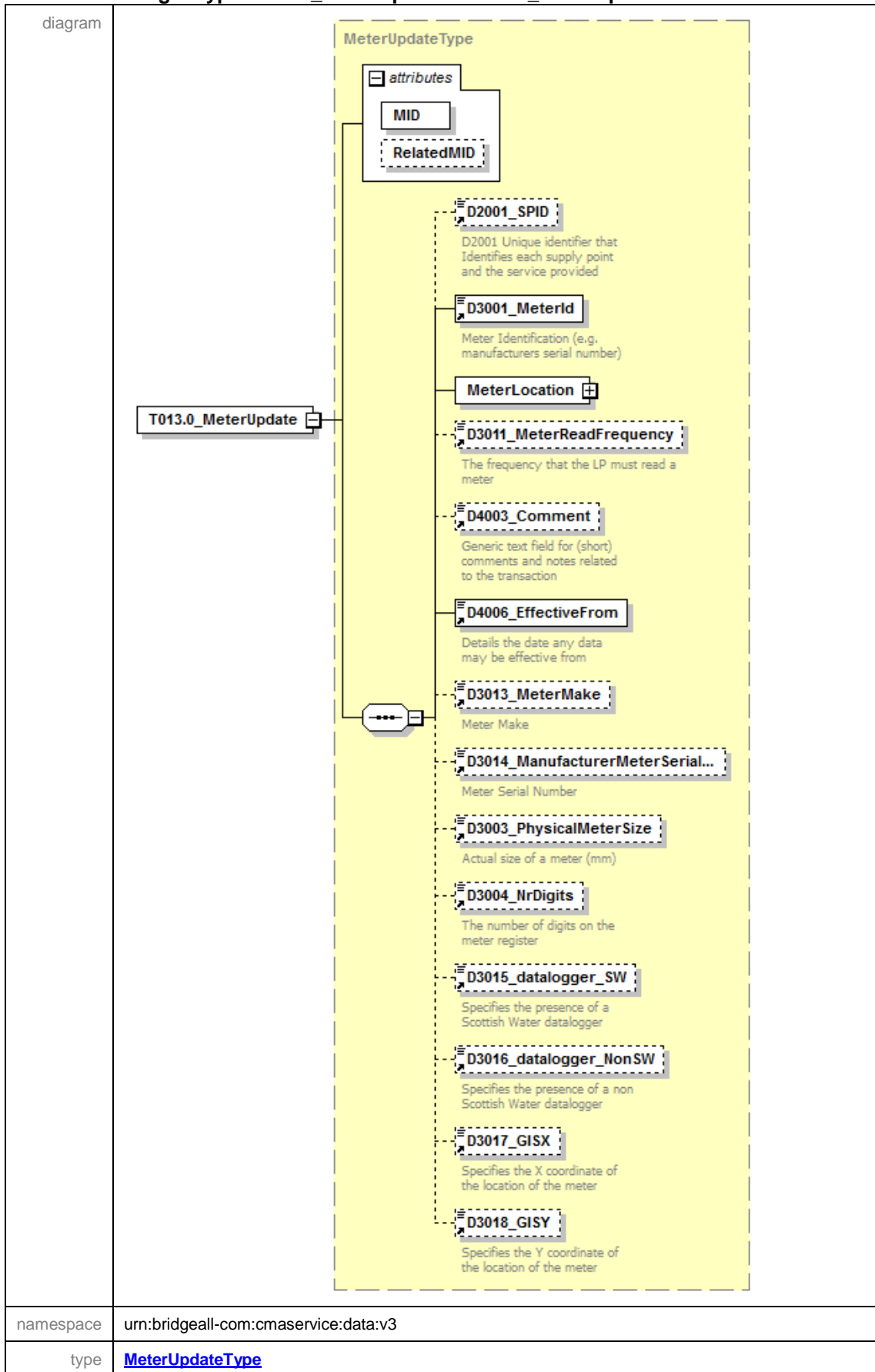

properties	isRef 0 content complex																		
children	D2001 SPID D3001 MeterId MeterLocation D3011 MeterReadFrequency D4003 Comment D4006 EffectiveFrom D3013 MeterMake D3014 ManufacturerMeterSerialNr D3003 PhysicalMeterSize D3004 NrDigits D3015 datalogger SW D3016 datalogger NonSW D3017 GISX D3018 GISY																		
attributes	<table border="1"> <thead> <tr> <th>Name</th> <th>Type</th> <th>Use</th> <th>Default</th> <th>Fixed</th> <th>annotation</th> </tr> </thead> <tbody> <tr> <td>MID</td> <td>MessageIdType</td> <td>required</td> <td></td> <td></td> <td></td> </tr> <tr> <td>RelatedMID</td> <td>MessageIdType</td> <td>optional</td> <td></td> <td></td> <td></td> </tr> </tbody> </table>	Name	Type	Use	Default	Fixed	annotation	MID	MessageIdType	required				RelatedMID	MessageIdType	optional			
Name	Type	Use	Default	Fixed	annotation														
MID	MessageIdType	required																	
RelatedMID	MessageIdType	optional																	
source	<code><xs:element name="T013.0_MeterUpdate" type="MeterUpdateType"/></code>																		

element MessagesType/T013.2_UpdateMeterLocations

diagram	<pre> classDiagram class T013_2_UpdateMeterLocations { T013_2_UpdateMeterLocation 1..∞ } </pre>
namespace	urn:bridgeall-com:cmaservice:data:v3
properties	isRef 0 content complex
children	T013.2 UpdateMeterLocation
source	<pre> <xs:element name="T013.2_UpdateMeterLocations"> <xs:complexType> <xs:sequence maxOccurs="unbounded"> <xs:element name="T013.2_UpdateMeterLocation" type="UpdateMeterLocationType"/> </xs:sequence> </xs:complexType> </xs:element> </pre>

element **MessagesType/T013.2_UpdateMeterLocations/T013.2_UpdateMeterLocation**

diagram																			
namespace	urn:bridgeall-com:cmaservice:data:v3																		
type	UpdateMeterLocationType																		
properties	isRef 0 content complex																		
children	D2001_SPID D3001_MeterId D3019_GISZFreeDescriptor D3025_MeterLocationCode																		
attributes	<table border="1"> <thead> <tr> <th>Name</th> <th>Type</th> <th>Use</th> <th>Default</th> <th>Fixed</th> <th>annotation</th> </tr> </thead> <tbody> <tr> <td>MID</td> <td>MessageIdType</td> <td>required</td> <td></td> <td></td> <td></td> </tr> <tr> <td>RelatedMID</td> <td>MessageIdType</td> <td>optional</td> <td></td> <td></td> <td></td> </tr> </tbody> </table>	Name	Type	Use	Default	Fixed	annotation	MID	MessageIdType	required				RelatedMID	MessageIdType	optional			
Name	Type	Use	Default	Fixed	annotation														
MID	MessageIdType	required																	
RelatedMID	MessageIdType	optional																	
source	<code><xs:element name="T013.2_UpdateMeterLocation" type="UpdateMeterLocationType"/></code>																		

element **MessagesType/T014.0_ChargeableMeterUpdates**

diagram	
namespace	urn:bridgeall-com:cmaservice:data:v3
properties	isRef 0 content complex
children	T014.0_ChargeableMeterUpdate
source	<pre> <xs:element name="T014.0_ChargeableMeterUpdates"> <xs:complexType> <xs:sequence maxOccurs="unbounded"> <xs:element name="T014.0_ChargeableMeterUpdate" type="ChargeableMeterUpdateType"/> </xs:sequence> </xs:complexType> </pre>

```
</xs:element>
```

element
MessagesType/T014.0_ChargeableMeterUpdates/T014.0_ChargeableMeterUpdate

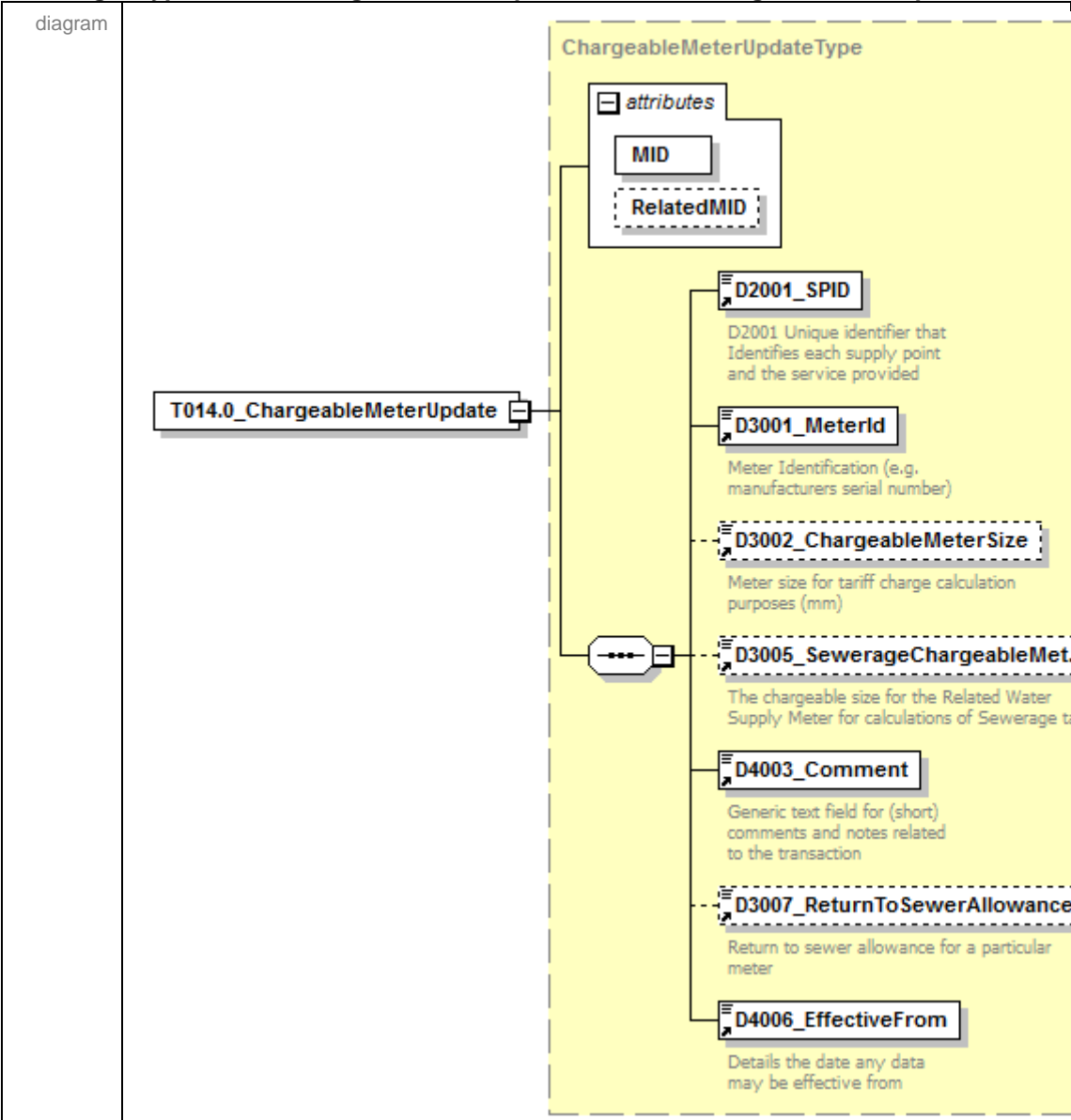

namespace	urn:bridgeall-com:cmaservice:data:v3					
type	ChargeableMeterUpdateType					
properties	isRef	0	content	complex		
children	D2001_SPID D3001_MeterId D3002_ChargeableMeterSize D3005_SewerageChargeableMeterSize D4003_Comment D3007_ReturnToSewerAllowance D4006_EffectiveFrom					
attributes	Name	Type	Use	Default	Fixed	annotation
	MID	MessageIdType	required			
	RelatedMID	MessageIdType	optional			
source	<code><xs:element name="T014.0_ChargeableMeterUpdate" type="ChargeableMeterUpdateType"/></code>					

element **MessagesType/T015.0_DisconnectionDeclarations**

diagram	
namespace	urn:bridgeall-com:cmaservice:data:v3
properties	isRef 0 content complex
children	T015.0_DisconnectionDeclaration
source	<pre><xs:element name="T015.0_DisconnectionDeclarations"> <xs:complexType> <xs:sequence maxOccurs="unbounded"> <xs:element name="T015.0_DisconnectionDeclaration" type="DisconnectionType"/> </xs:sequence> </xs:complexType> </xs:element></pre>

element **MessagesType/T015.0_DisconnectionDeclarations/T015.0_DisconnectionDeclaration**

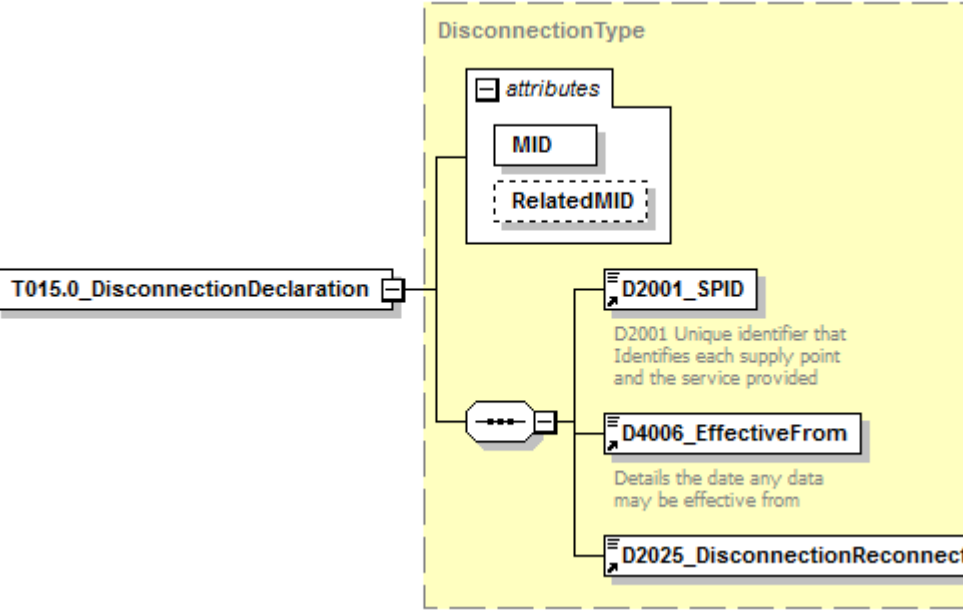
diagram																			
namespace	urn:bridgeall-com:cmaservice:data:v3																		
type	DisconnectionType																		
properties	isRef 0 content complex																		
children	D2001_SPID D4006_EffectiveFrom D2025_DisconnectionReconnection																		
attributes	<table border="1"> <thead> <tr> <th>Name</th> <th>Type</th> <th>Use</th> <th>Default</th> <th>Fixed</th> <th>annotation</th> </tr> </thead> <tbody> <tr> <td>MID</td> <td>MessageIdType</td> <td>required</td> <td></td> <td></td> <td></td> </tr> <tr> <td>RelatedMID</td> <td>MessageIdType</td> <td>optional</td> <td></td> <td></td> <td></td> </tr> </tbody> </table>	Name	Type	Use	Default	Fixed	annotation	MID	MessageIdType	required				RelatedMID	MessageIdType	optional			
Name	Type	Use	Default	Fixed	annotation														
MID	MessageIdType	required																	
RelatedMID	MessageIdType	optional																	
source	<pre><xs:element name="T015.0_DisconnectionDeclaration" type="DisconnectionType"/></pre>																		

element **MessagesType/T016.0_UnmeasureableDeclarations**

diagram	
namespace	urn:bridgeall-com:cmaservice:data:v3
properties	isRef 0 content complex
children	T016.0_UnmeasureableDeclaration
source	<pre><xs:element name="T016.0_UnmeasureableDeclarations"> <xs:complexType> <xs:sequence maxOccurs="unbounded"> <xs:element name="T016.0_UnmeasureableDeclaration" type="T016.0_UnmeasureableDeclarationType"/> </xs:sequence> </xs:complexType> </xs:element></pre>

element **MessagesType/T016.0_UnmeasureableDeclarations/T016.0_UnmeasureableDeclaration**

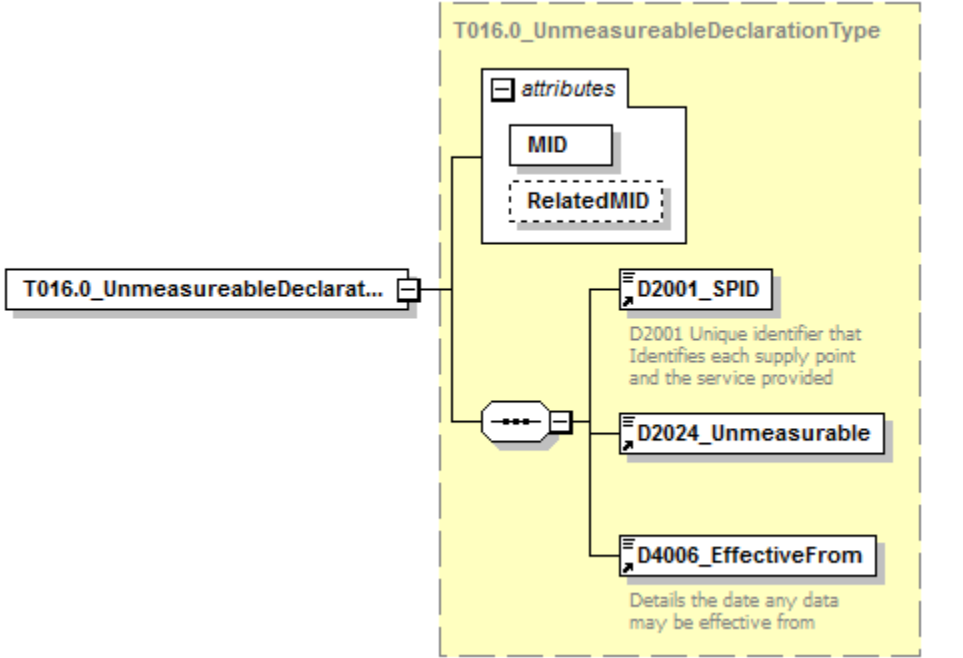
diagram																			
namespace	urn:bridgeall-com:cmaservice:data:v3																		
type	T016.0_UnmeasureableDeclarationType																		
properties	isRef 0 content complex																		
children	D2001_SPID D2024_Unmeasurable D4006_EffectiveFrom																		
attributes	<table border="1"> <thead> <tr> <th>Name</th> <th>Type</th> <th>Use</th> <th>Default</th> <th>Fixed</th> <th>annotation</th> </tr> </thead> <tbody> <tr> <td>MID</td> <td>MessageIdType</td> <td>required</td> <td></td> <td></td> <td></td> </tr> <tr> <td>RelatedMID</td> <td>MessageIdType</td> <td>optional</td> <td></td> <td></td> <td></td> </tr> </tbody> </table>	Name	Type	Use	Default	Fixed	annotation	MID	MessageIdType	required				RelatedMID	MessageIdType	optional			
Name	Type	Use	Default	Fixed	annotation														
MID	MessageIdType	required																	
RelatedMID	MessageIdType	optional																	
source	<pre><xs:element name="T016.0_UnmeasureableDeclaration"</pre>																		

	<code>type="T016.0_UnmeasureableDeclarationType"/></code>
--	--

element MessagesType/T017.0_MeterSwaps

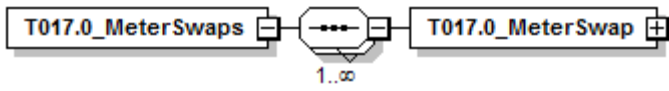
diagram	
namespace	urn:bridgeall-com:cmaservice:data:v3
properties	isRef 0 content complex
children	T017.0_MeterSwap
source	<pre><xs:element name="T017.0_MeterSwaps"> <xs:complexType> <xs:sequence maxOccurs="unbounded"> <xs:element name="T017.0_MeterSwap" type="MeterSwapType"/> </xs:sequence> </xs:complexType> </xs:element></pre>

element MessagesType/T017.0_MeterSwaps/T017.0_MeterSwap

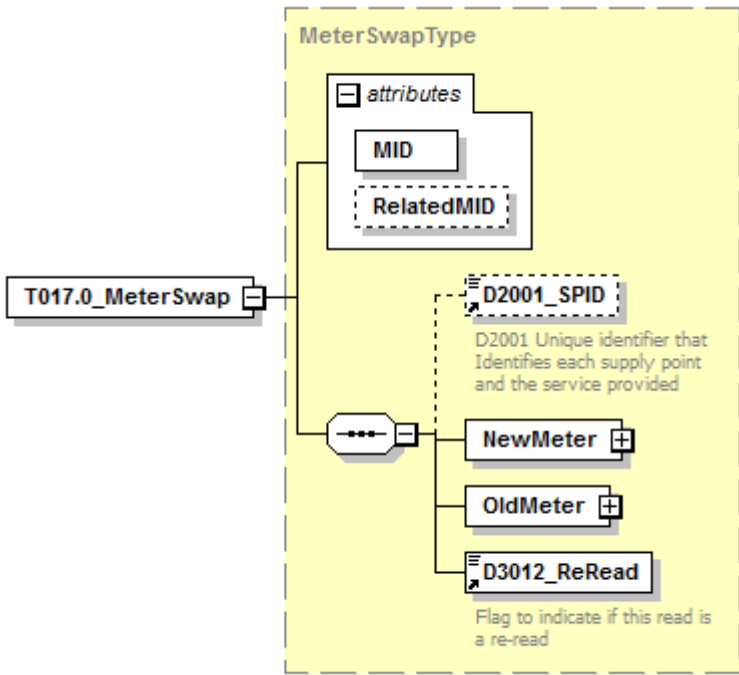
diagram						
namespace	urn:bridgeall-com:cmaservice:data:v3					
type	MeterSwapType					
properties	isRef 0 content complex					
children	D2001_SPID NewMeter OldMeter D3012_ReRead					
attributes	Name	Type	Use	Default	Fixed	annotation
	MID	MessageIdType	required			
	RelatedMID	MessageIdType	optional			
source	<pre><xs:element name="T017.0_MeterSwap" type="MeterSwapType"/></pre>					

element **MessagesType/T021.0_NewDPIDs**

diagram	
namespace	urn:bridgeall-com:cmaservice:data:v3
properties	isRef 0 content complex
children	T021.0_NewDPID
source	<pre> <xs:element name="T021.0_NewDPIDs"> <xs:complexType> <xs:sequence maxOccurs="unbounded"> <xs:element name="T021.0_NewDPID" type="DPIDNotificationType"/> </xs:sequence> </xs:complexType> </xs:element> </pre>

element **MessageType/T021.0_NewDPIDs/T021.0_NewDPID**

<p>diagram</p>	<p>The diagram illustrates the structure of the DPIDNotificationType element. It is contained within a dashed yellow box. At the top, there is an attributes section with two elements: MID and RelatedMID. Below this, a vertical list of data elements is shown, each with a description:</p> <ul style="list-style-type: none"> D2001_SPID: D2001 Unique identifier that Identifies each supply point and the service provided D6001_DPID: Discharge Point ID D4006_EffectiveFrom: Details the date any data may be effective from D6003_CDV: TE Availability data: Chargeable Daily Volume m3 D6004_sBODL: TE Availability data: Chargeable Settled Biochemical Oxygen Demand load (kg/day) D6005_TSSL: TE Availability data: Chargeable Total Suspended Solids load (kg/day) D6006_Ot: TE Operating Data: Fixed Strength Chemical Oxygen Demand D6007_St: TE Operating Data: Fixed Strength Solids Demand D6009_Non-domesticAllowance: Annual volume associated with the foul sewerage for the Discharge Point (m3) D6010_SDTIndicator: Seasonal Discharge Tariff Indicator - set as True to apply higher seasonal tariff Address: (indicated with a plus sign icon) D6002_TEYVe: Trade Effluent Estimated Yearly Volume for a Discharge Point D6011_TETreatment: TETreatment indicator D6012_PcentAllowance: DPID Percentage Allowance D6013_FixedAllowance: DPID Fixed Allowance <p>A box labeled T021.0_NewDPID is connected to the DPIDNotificationType structure.</p>
<p>namespace</p>	<p>urn:bridgeall-com:cmaservice:data:v3</p>
<p>type</p>	<p>DPIDNotificationType</p>

properties	isRef 0 content complex																		
children	D2001_SPID D6001_DPID D4006_EffectiveFrom D6003_CDV D6004_sBODL D6005_TSSL D6006_Ot D6007_St D6009_Non-domesticAllowance D6010_SDTIndicator Address D6002_TeYVe D6011_TETreatment D6012_PcentAllowance D6013_FixedAllowance																		
attributes	<table border="1"> <thead> <tr> <th>Name</th> <th>Type</th> <th>Use</th> <th>Default</th> <th>Fixed</th> <th>annotation</th> </tr> </thead> <tbody> <tr> <td>MID</td> <td>MessageIdType</td> <td>required</td> <td></td> <td></td> <td></td> </tr> <tr> <td>RelatedMID</td> <td>MessageIdType</td> <td>optional</td> <td></td> <td></td> <td></td> </tr> </tbody> </table>	Name	Type	Use	Default	Fixed	annotation	MID	MessageIdType	required				RelatedMID	MessageIdType	optional			
Name	Type	Use	Default	Fixed	annotation														
MID	MessageIdType	required																	
RelatedMID	MessageIdType	optional																	
source	<code><xs:element name="T021.0_NewDPID" type="DPIDNotificationType"/></code>																		

element **MessagesType/T022.0_TEUpdates**

diagram	
namespace	urn:bridgeall-com:cmaservice:data:v3
properties	isRef 0 content complex
children	T022.0_TEUpdate
source	<pre> <xs:element name="T022.0_TEUpdates"> <xs:complexType> <xs:sequence maxOccurs="unbounded"> <xs:element name="T022.0_TEUpdate" type="TEUpdateType"/> </xs:sequence> </xs:complexType> </xs:element> </pre>

element **MessageType/T022.0_TEUpdates/T022.0_TEUpdate**

diagram																			
namespace	urn:bridgeall-com:cmaservice:data:v3																		
type	TEUpdateType																		
properties	isRef 0 content complex																		
children	D2001_SPID D6001_DPID D4006_EffectiveFrom D6006_Ot D6007_St																		
attributes	<table border="1"> <thead> <tr> <th>Name</th> <th>Type</th> <th>Use</th> <th>Default</th> <th>Fixed</th> <th>annotation</th> </tr> </thead> <tbody> <tr> <td>MID</td> <td>MessageIdType</td> <td>required</td> <td></td> <td></td> <td></td> </tr> <tr> <td>RelatedMID</td> <td>MessageIdType</td> <td>optional</td> <td></td> <td></td> <td></td> </tr> </tbody> </table>	Name	Type	Use	Default	Fixed	annotation	MID	MessageIdType	required				RelatedMID	MessageIdType	optional			
Name	Type	Use	Default	Fixed	annotation														
MID	MessageIdType	required																	
RelatedMID	MessageIdType	optional																	
source	<code><xs:element name="T022.0_TEUpdate" type="TEUpdateType"/></code>																		

element **MessageType/T023.0_MeterAssociations**

diagram	
namespace	urn:bridgeall-com:cmaservice:data:v3
properties	isRef 0 content complex
children	T023.0_MeterAssociation
source	<pre> <xs:element name="T023.0_MeterAssociations"> <xs:complexType> <xs:sequence maxOccurs="unbounded"> <xs:element name="T023.0_MeterAssociation" </pre>

```

type="MeterAssociationType"/>
</xs:sequence>
</xs:complexType>
</xs:element>

```

element **MessagesType/T023.0_MeterAssociations/T023.0_MeterAssociation**

diagram																			
namespace	urn:bridgeall-com:cmaservice:data:v3																		
type	MeterAssociationType																		
properties	isRef 0 content complex																		
children	D2001_SPID DPID D3001_MeterId D4006_EffectiveFrom D3024_MDVol																		
attributes	<table border="1"> <thead> <tr> <th>Name</th> <th>Type</th> <th>Use</th> <th>Default</th> <th>Fixed</th> <th>annotation</th> </tr> </thead> <tbody> <tr> <td>MID</td> <td>MessageldType</td> <td>required</td> <td></td> <td></td> <td></td> </tr> <tr> <td>RelatedMID</td> <td>MessageldType</td> <td>optional</td> <td></td> <td></td> <td></td> </tr> </tbody> </table>	Name	Type	Use	Default	Fixed	annotation	MID	MessageldType	required				RelatedMID	MessageldType	optional			
Name	Type	Use	Default	Fixed	annotation														
MID	MessageldType	required																	
RelatedMID	MessageldType	optional																	
source	<xs:element name="T023.0_MeterAssociation" type="MeterAssociationType"/>																		

element **MessagesType/T024.0_MeterDisAssociations**

diagram	
namespace	urn:bridgeall-com:cmaservice:data:v3
properties	isRef 0

	content complex
children	T024.0_MeterDisAssociation
source	<pre> <xs:element name="T024.0_MeterDisAssociations"> <xs:complexType> <xs:sequence maxOccurs="unbounded"> <xs:element name="T024.0_MeterDisAssociation" type="MeterDisAssociationType"/> </xs:sequence> </xs:complexType> </xs:element> </pre>

element **MessagesType/T024.0_MeterDisAssociations/T024.0_MeterDisAssociation**

diagram																			
namespace	urn:bridgeall-com:cmaservice:data:v3																		
type	MeterDisAssociationType																		
properties	isRef 0 content complex																		
children	D2001_SPID D6001_DPID D3001_MeterId D4006_EffectiveFrom																		
attributes	<table border="1"> <thead> <tr> <th>Name</th> <th>Type</th> <th>Use</th> <th>Default</th> <th>Fixed</th> <th>annotation</th> </tr> </thead> <tbody> <tr> <td>MID</td> <td>MessageIdType</td> <td>required</td> <td></td> <td></td> <td></td> </tr> <tr> <td>RelatedMID</td> <td>MessageIdType</td> <td>optional</td> <td></td> <td></td> <td></td> </tr> </tbody> </table>	Name	Type	Use	Default	Fixed	annotation	MID	MessageIdType	required				RelatedMID	MessageIdType	optional			
Name	Type	Use	Default	Fixed	annotation														
MID	MessageIdType	required																	
RelatedMID	MessageIdType	optional																	
source	<pre> <xs:element name="T024.0_MeterDisAssociation" type="MeterDisAssociationType"/> </pre>																		

element **MessagesType/T026.0_DiscontinueDPIDs**

diagram	
---------	--

namespace	urn:bridgeall-com:cmaservice:data:v3
properties	isRef 0 content complex
children	T026.0_DiscontinueDPID
source	<pre> <xs:element name="T026.0_DiscontinueDPIDs"> <xs:complexType> <xs:sequence maxOccurs="unbounded"> <xs:element name="T026.0_DiscontinueDPID" type="DiscontinueDPIDType"/> </xs:sequence> </xs:complexType> </xs:element> </pre>

element **MessagesType/T026.0_DiscontinueDPIDs/T026.0_DiscontinueDPID**

diagram																			
namespace	urn:bridgeall-com:cmaservice:data:v3																		
type	DiscontinueDPIDType																		
properties	isRef 0 content complex																		
children	D2001_SPID D6001_DPID D4006_EffectiveFrom																		
attributes	<table border="1"> <thead> <tr> <th>Name</th> <th>Type</th> <th>Use</th> <th>Default</th> <th>Fixed</th> <th>annotation</th> </tr> </thead> <tbody> <tr> <td>MID</td> <td>MessageIdType</td> <td>required</td> <td></td> <td></td> <td></td> </tr> <tr> <td>RelatedMID</td> <td>MessageIdType</td> <td>optional</td> <td></td> <td></td> <td></td> </tr> </tbody> </table>	Name	Type	Use	Default	Fixed	annotation	MID	MessageIdType	required				RelatedMID	MessageIdType	optional			
Name	Type	Use	Default	Fixed	annotation														
MID	MessageIdType	required																	
RelatedMID	MessageIdType	optional																	
source	<code><xs:element name="T026.0_DiscontinueDPID" type="DiscontinueDPIDType"/></code>																		

element **MessagesType/T027.0_DPIDUpdates**

diagram	
namespace	urn:bridgeall-com:cmaservice:data:v3

properties	isRef 0 content complex
children	T027.0 DPIDUpdate
source	<pre> <xs:element name="T027.0_DPIDUpdates"> <xs:complexType> <xs:sequence maxOccurs="unbounded"> <xs:element name="T027.0_DPIDUpdate" type="DPIDUpdateType"/> </xs:sequence> </xs:complexType> </xs:element> </pre>

element **MessagesType/T027.0_DPIDUpdates/T027.0_DPIDUpdate**

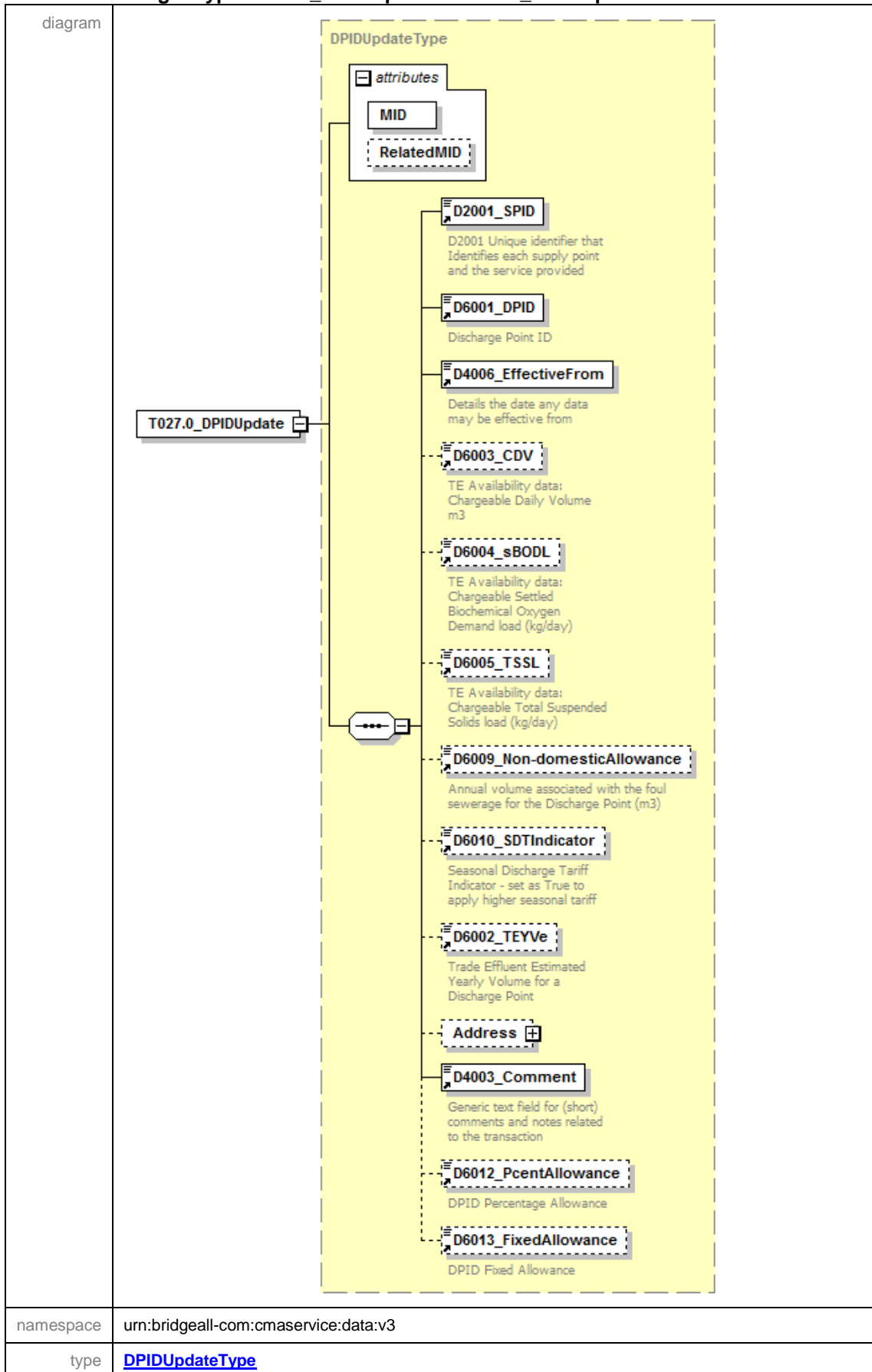

properties	isRef 0 content complex																		
children	D2001_SPID D6001_DPID D4006_EffectiveFrom D6003_CDV D6004_sBODL D6005_TSSL D6009_Non-domesticAllowance D6010_SDIndicator D6002_TYVe Address D4003_Comment D6012_PcentAllowance D6013_FixedAllowance																		
attributes	<table border="1"> <thead> <tr> <th>Name</th> <th>Type</th> <th>Use</th> <th>Default</th> <th>Fixed</th> <th>annotation</th> </tr> </thead> <tbody> <tr> <td>MID</td> <td>MessageIdType</td> <td>required</td> <td></td> <td></td> <td></td> </tr> <tr> <td>RelatedMID</td> <td>MessageIdType</td> <td>optional</td> <td></td> <td></td> <td></td> </tr> </tbody> </table>	Name	Type	Use	Default	Fixed	annotation	MID	MessageIdType	required				RelatedMID	MessageIdType	optional			
Name	Type	Use	Default	Fixed	annotation														
MID	MessageIdType	required																	
RelatedMID	MessageIdType	optional																	
source	<code><xs:element name="T027.0_DPIDUpdate" type="DPIDUpdateType"/></code>																		

element **MessagesType/T028.1_Schedule3Updates**

diagram	
namespace	urn:bridgeall-com:cmaservice:data:v3
properties	isRef 0 content complex
children	T028.1_Schedule3Update
source	<pre> <xs:element name="T028.1_Schedule3Updates"> <xs:complexType> <xs:sequence maxOccurs="unbounded"> <xs:element name="T028.1_Schedule3Update" type="Schedule3UpdateType"/> </xs:sequence> </xs:complexType> </xs:element> </pre>

element **MessagesType/T028.1_Schedule3Updates/T028.1_Schedule3Update**

diagram																			
namespace	urn:bridgeall-com:cmaservice:data:v3																		
type	Schedule3UpdateType																		
properties	isRef 0 content complex																		
children	D2001_SPID D2003_Schedule3 D4006_EffectiveFrom D6001_DPID																		
attributes	<table border="1"> <thead> <tr> <th>Name</th> <th>Type</th> <th>Use</th> <th>Default</th> <th>Fixed</th> <th>annotation</th> </tr> </thead> <tbody> <tr> <td>MID</td> <td>MessageIdType</td> <td>required</td> <td></td> <td></td> <td></td> </tr> <tr> <td>RelatedMID</td> <td>MessageIdType</td> <td>optional</td> <td></td> <td></td> <td></td> </tr> </tbody> </table>	Name	Type	Use	Default	Fixed	annotation	MID	MessageIdType	required				RelatedMID	MessageIdType	optional			
Name	Type	Use	Default	Fixed	annotation														
MID	MessageIdType	required																	
RelatedMID	MessageIdType	optional																	
source	<code><xs:element name="T028.1_Schedule3Update" type="Schedule3UpdateType"/></code>																		

element **MessagesType/T029.1_SpecialArrangementsUpdates**

diagram	
namespace	urn:bridgeall-com:cmaservice:data:v3
properties	isRef 0 content complex
children	T029.1_SpecialArrangementsUpdate
source	<pre> <xs:element name="T029.1_SpecialArrangementsUpdates"> <xs:complexType> <xs:sequence maxOccurs="unbounded"> <xs:element name="T029.1_SpecialArrangementsUpdate" type="SpecialArrangementsUpdateType"/> </xs:sequence> </xs:complexType> </pre>

</xs:element>

element
MessagesType/T029.1_SpecialArrangementsUpdates/T029.1_SpecialArrangementsUpdate

diagram																			
namespace	urn:bridgeall-com:cmaservice:data:v3																		
type	SpecialArrangementsUpdateType																		
properties	isRef 0 content complex																		
children	D2001_SPID D4006_EffectiveFrom D2003_Schedule3 D2006_29e D2007_LargeVolAgreement																		
attributes	<table border="1"> <thead> <tr> <th>Name</th> <th>Type</th> <th>Use</th> <th>Default</th> <th>Fixed</th> <th>annotation</th> </tr> </thead> <tbody> <tr> <td>MID</td> <td>MessageIdType</td> <td>required</td> <td></td> <td></td> <td></td> </tr> <tr> <td>RelatedMID</td> <td>MessageIdType</td> <td>optional</td> <td></td> <td></td> <td></td> </tr> </tbody> </table>	Name	Type	Use	Default	Fixed	annotation	MID	MessageIdType	required				RelatedMID	MessageIdType	optional			
Name	Type	Use	Default	Fixed	annotation														
MID	MessageIdType	required																	
RelatedMID	MessageIdType	optional																	
source	<xs:element name="T029.1_SpecialArrangementsUpdate" type="SpecialArrangementsUpdateType"/>																		

element **MessagesType/T029.3_PremisesSpecialArrangementsUpdates**

diagram	
namespace	urn:bridgeall-com:cmaservice:data:v3

e	
properties	isRef 0 content complex
children	T029.3_PremisesSpecialArrangementsUpdate
source	<pre><xs:element name="T029.3_PremisesSpecialArrangementsUpdates"> <xs:complexType> <xs:sequence maxOccurs="unbounded"> <xs:element name="T029.3_PremisesSpecialArrangementsUpdate" type="PremisesSpecialArrangementsUpdateType"/> </xs:sequence> </xs:complexType> </xs:element></pre>

element
MessagesType/T029.3_PremisesSpecialArrangementsUpdates/T029.3_PremisesSpecialArrangementsUpdate

diagram																			
namespace	urn:bridgeall-com:cmaservice:data:v3																		
type	PremisesSpecialArrangementsUpdateType																		
properties	isRef 0 content complex																		
children	D2001_SPID D4006_EffectiveFrom D2004_ExemptCustomerFlag D2041_PcentExemption																		
attributes	<table border="1"> <thead> <tr> <th>Name</th> <th>Type</th> <th>Use</th> <th>Default</th> <th>Fixed</th> <th>annotation</th> </tr> </thead> <tbody> <tr> <td>MID</td> <td>MessageIdType</td> <td>required</td> <td></td> <td></td> <td></td> </tr> <tr> <td>RelatedMID</td> <td>MessageIdType</td> <td>optional</td> <td></td> <td></td> <td></td> </tr> </tbody> </table>	Name	Type	Use	Default	Fixed	annotation	MID	MessageIdType	required				RelatedMID	MessageIdType	optional			
Name	Type	Use	Default	Fixed	annotation														
MID	MessageIdType	required																	
RelatedMID	MessageIdType	optional																	
source	<pre><xs:element name="T029.3_PremisesSpecialArrangementsUpdate" type="PremisesSpecialArrangementsUpdateType"/></pre>																		

element **MessagesType/T032.0_CreateUpdateCustomerName**

diagram	
namespace	urn:bridgeall-com:cmaservice:data:v3
properties	isRef 0 content complex
children	T032.0_CreateUpdateCustomerName
source	<pre><xs:element name="T032.0_CreateUpdateCustomerName"> <xs:complexType> <xs:sequence maxOccurs="unbounded"> <xs:element name="T032.0_CreateUpdateCustomerName" type="T032.0_CreateUpdateCustomerNameType"/> </xs:sequence> </xs:complexType> </xs:element></pre>

element **MessagesType/T032.0_CreateUpdateCustomerName/T032.0_CreateUpdateCustomerNameType**

diagram																			
namespace	urn:bridgeall-com:cmaservice:data:v3																		
type	T032.0_CreateUpdateCustomerNameType																		
properties	isRef 0 content complex																		
children	D2001_SPID D2027_CustomerName D2028_CustomerNameType																		
attributes	<table border="1"> <thead> <tr> <th>Name</th> <th>Type</th> <th>Use</th> <th>Default</th> <th>Fixed</th> <th>annotation</th> </tr> </thead> <tbody> <tr> <td>MID</td> <td>MessageIdType</td> <td>required</td> <td></td> <td></td> <td></td> </tr> <tr> <td>RelatedMID</td> <td>MessageIdType</td> <td>optional</td> <td></td> <td></td> <td></td> </tr> </tbody> </table>	Name	Type	Use	Default	Fixed	annotation	MID	MessageIdType	required				RelatedMID	MessageIdType	optional			
Name	Type	Use	Default	Fixed	annotation														
MID	MessageIdType	required																	
RelatedMID	MessageIdType	optional																	

source	<code><xs:element name="T032.0_CreateUpdateCustomerName" type="T032.0_CreateUpdateCustomerNameType"/></code>
--------	--

element **MessagesType/T033.0_MeteredBuildings**

diagram	
namespace	urn:bridgeall-com:cmaservice:data:v3
properties	isRef 0 content complex
children	T033.0_MeteredBuilding
source	<code><xs:element name="T033.0_MeteredBuildings"> <xs:complexType> <xs:sequence maxOccurs="unbounded"> <xs:element name="T033.0_MeteredBuilding" type="T033.0_MeteredBuilding"/> </xs:sequence> </xs:complexType> </xs:element></code>

element **MessagesType/T033.0_MeteredBuildings/T033.0_MeteredBuilding**

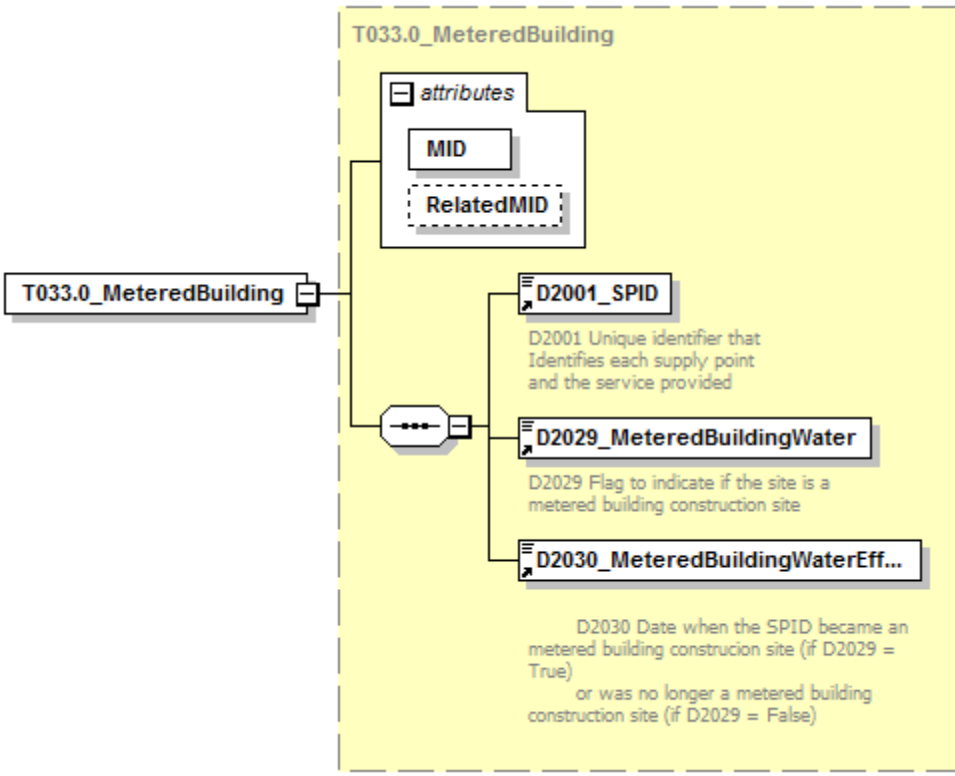
diagram	
namespace	urn:bridgeall-com:cmaservice:data:v3
type	T033.0_MeteredBuilding
properties	isRef 0 content complex

children	D2001_SPID D2029_MeteredBuildingWater D2030_MeteredBuildingWaterEffectiveDate					
attributes	Name	Type	Use	Default	Fixed	annotation
	MID	MessageIdType	required			
	RelatedMID	MessageIdType	optional			
source	<xs:element name="T033.0_MeteredBuilding" type="T033.0_MeteredBuilding"/>					

element **MessagesType/T034.0_VacSchemeApplications**

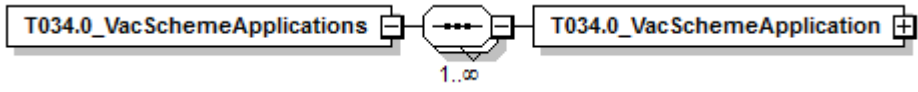
diagram	
namespace	urn:bridgeall-com:cmaservice:data:v3
properties	isRef 0 content complex
children	T034.0_VacSchemeApplication
source	<pre><xs:element name="T034.0_VacSchemeApplications"> <xs:complexType> <xs:sequence maxOccurs="unbounded"> <xs:element name="T034.0_VacSchemeApplication" type="T034.0_VacSchemeApplication"/> </xs:sequence> </xs:complexType> </xs:element></pre>

element **MessagesType/T034.0_VacSchemeApplications/T034.0_VacSchemeApplication**

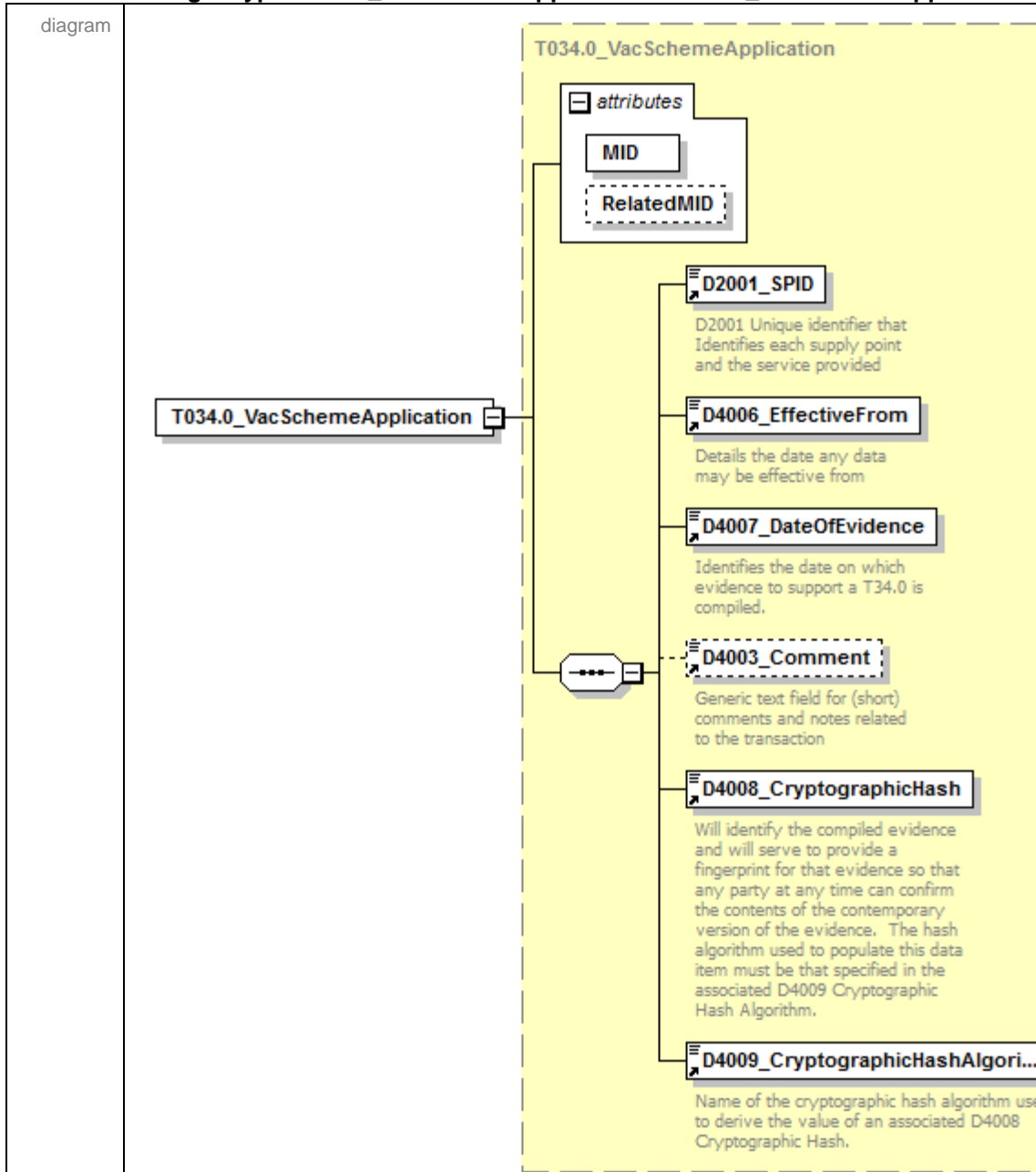

namespace	urn:bridgeall-com:cmaservice:data:v3					
type	T034.0_VacSchemeApplication					
properties	isRef	0	content	complex		
children	D2001_SPID D4006_EffectiveFrom D4007_DateOfEvidence D4003_Comment D4008_CryptographicHash D4009_CryptographicHashAlgorithm					
attributes	Name	Type	Use	Default	Fixed	annotation
	MID	MessageIDType	required			
	RelatedMID	MessageIDType	optional			
source	<pre><xs:element name="T034.0_VacSchemeApplication" type="T034.0_VacSchemeApplication"/></pre>					

element **MessagesType/T034.4_VacSchemeApplicationConfirmationOrCancellations**

diagram	
namespace	urn:bridgeall-com:cmaservice:data:v3
properties	isRef 0 content complex
children	T034.4_VacSchemeApplicationConfirmationOrCancellation
source	<pre> <xs:element name="T034.4_VacSchemeApplicationConfirmationOrCancellations"> <xs:complexType> <xs:sequence maxOccurs="unbounded"> <xs:element name="T034.4_VacSchemeApplicationConfirmationOrCancellation" type="T034.4_VacSchemeApplicationConfirmationOrCancellation"/> </xs:sequence> </xs:complexType> </xs:element> </pre>

element

MessageType/T034.4_VacSchemeApplicationConfirmationOrCancellations/T034.4_VacSchemeApplicationConfirmationOrCancellation

<p>diagram</p>																			
<p>namespace</p>	<p>urn:bridgeall-com:cmaservice:data:v3</p>																		
<p>type</p>	<p>T034.4_VacSchemeApplicationConfirmationOrCancellation</p>																		
<p>properties</p>	<p>isRef 0 content complex</p>																		
<p>children</p>	<p>D2001_SPID D4006_EffectiveFrom D4007_DateOfEvidence D2031_VacancyChangeFlag D2032_LPChallengedVacancyApplicationFlag D4003_Comment</p>																		
<p>attributes</p>	<table border="1"> <thead> <tr> <th>Name</th> <th>Type</th> <th>Use</th> <th>Default</th> <th>Fixed</th> <th>annotation</th> </tr> </thead> <tbody> <tr> <td>MID</td> <td>MessageIdType</td> <td>required</td> <td></td> <td></td> <td></td> </tr> <tr> <td>RelatedMID</td> <td>MessageIdType</td> <td>optional</td> <td></td> <td></td> <td></td> </tr> </tbody> </table>	Name	Type	Use	Default	Fixed	annotation	MID	MessageIdType	required				RelatedMID	MessageIdType	optional			
Name	Type	Use	Default	Fixed	annotation														
MID	MessageIdType	required																	
RelatedMID	MessageIdType	optional																	
<p>source</p>	<pre><xs:element name="T034.4_VacSchemeApplicationConfirmationOrCancellation" type="T034.4_VacSchemeApplicationConfirmationOrCancellation"/></pre>																		

element **MessagesType/T036.0_MeterNetworkAssociations**

diagram	
namespace	urn:bridgeall-com:cmaservice:data:v3
properties	isRef 0 content complex
children	T036.0_MeterNetworkAssociation
source	<pre> <xs:element name="T036.0_MeterNetworkAssociations"> <xs:complexType> <xs:sequence maxOccurs="unbounded"> <xs:element name="T036.0_MeterNetworkAssociation" type="MeterNetworkAssociationType"/> </xs:sequence> </xs:complexType> </xs:element> </pre>

element **MessagesType/T036.0_MeterNetworkAssociations/T036.0_MeterNetworkAssociation**

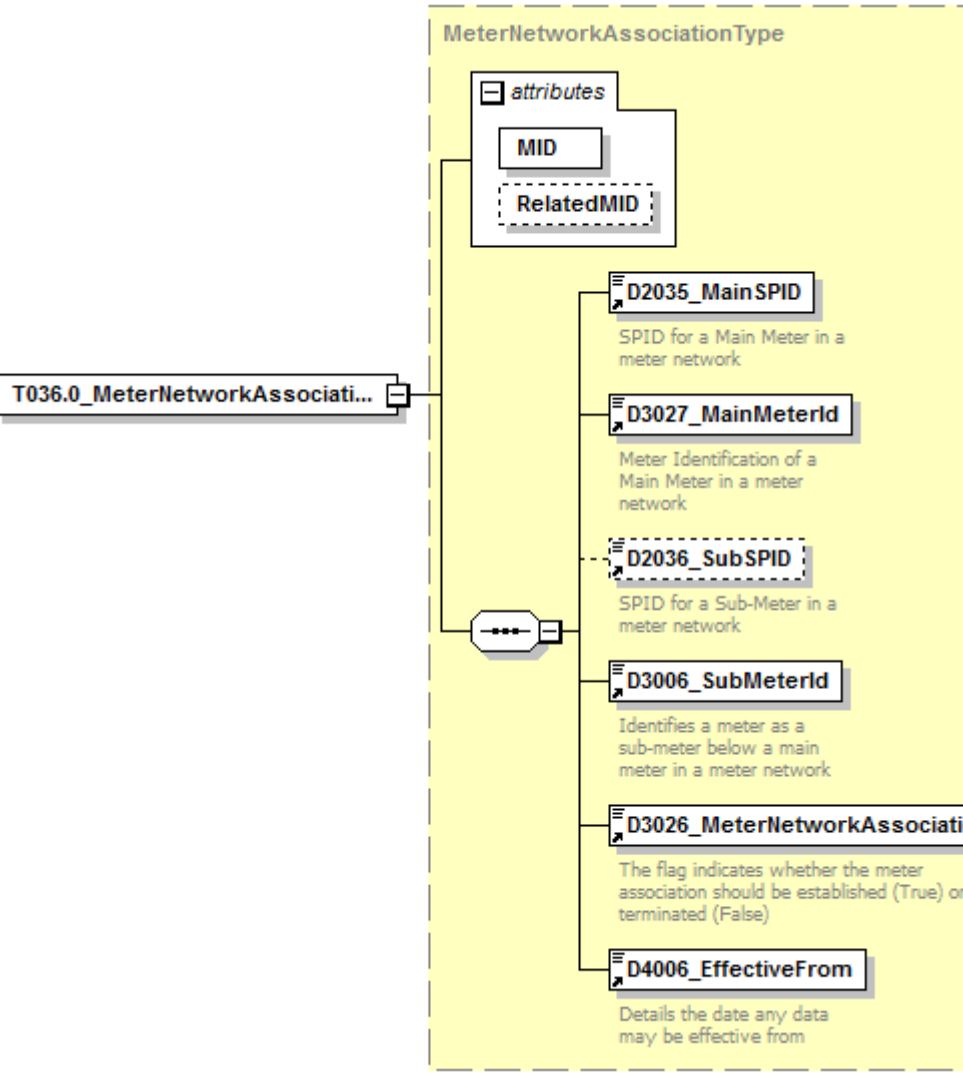
diagram	
---------	---

namespace	urn:bridgeall-com:cmaservice:data:v3					
type	MeterNetworkAssociationType					
properties	isRef	0				
	content	complex				
children	D2035 MainSPID D3027 MainMeterId D2036 SubSPID D3006 SubMeterId D3026 MeterNetworkAssociation D4006 EffectiveFrom					
attributes	Name	Type	Use	Default	Fixed	annotation
	MID	MessageIdType	required			
	RelatedMID	MessageIdType	optional			
source	<xs:element name="T036.0_MeterNetworkAssociation" type="MeterNetworkAssociationType"/>					

complexType MeterAssociationType

diagram						
namespace	urn:bridgeall-com:cmaservice:data:v3					
type	extension of MessageBody					
properties	base	MessageBody				
children	D2001 SPID D6001 DPID D3001 MeterId D4006 EffectiveFrom D3024 MDVol					
used by	elements	MessagesType/T023.0 MeterAssociations/T023.0 MeterAssociation ResponseMessagesType/T023.1 MeterAssociationNotification				
attributes	Name	Type	Use	Default	Fixed	annotation
	MID	MessageIdType	required			
	RelatedMID	MessageIdType	optional			

annotation	documentation
source	<pre> <xs:complexType name="MeterAssociationType"> <xs:annotation> <xs:documentation> </xs:documentation> </xs:annotation> <xs:complexContent> <xs:extension base="MessageBody"> <xs:sequence> <xs:element ref="D2001_SPID"/> <xs:element ref="D6001_DPID"/> <xs:element ref="D3001_MeterId"/> <xs:element ref="D4006_EffectiveFrom"/> <xs:element ref="D3024_MDVol"/> </xs:sequence> </xs:extension> </xs:complexContent> </xs:complexType> </pre>

complexType **MeterDisAssociationType**

diagram													
namespace	urn:bridgeall-com:cmaservice:data:v3												
type	extension of MessageBody												
properties	base MessageBody												
children	D2001_SPID D6001_DPID D3001_MeterId D4006_EffectiveFrom												
used by	elements MessagesType/T024.0_MeterDisAssociations/T024.0_MeterDisAssociationResponseMessagesType/T024.1_MeterDisAssociationNotification												
attributes	<table border="1"> <thead> <tr> <th>Name</th> <th>Type</th> <th>Use</th> <th>Default</th> <th>Fixed</th> <th>annotation</th> </tr> </thead> <tbody> <tr> <td>MID</td> <td>MessageIdType</td> <td>required</td> <td></td> <td></td> <td></td> </tr> </tbody> </table>	Name	Type	Use	Default	Fixed	annotation	MID	MessageIdType	required			
Name	Type	Use	Default	Fixed	annotation								
MID	MessageIdType	required											

	RelatedMID MessageIdType optional
annotation	documentation
source	<pre> <xs:complexType name="MeterDisAssociationType"> <xs:annotation> <xs:documentation> </xs:documentation> </xs:annotation> <xs:complexContent> <xs:extension base="MessageBody"> <xs:sequence> <xs:element ref="D2001_SPID"/> <xs:element ref="D6001_DPID"/> <xs:element ref="D3001_MeterId"/> <xs:element ref="D4006_EffectiveFrom"/> </xs:sequence> </xs:extension> </xs:complexContent> </xs:complexType> </pre>

complexType **MeterNetworkAssociationType**

diagram																			
namespace	urn:bridgeall-com:cmaservice:data:v3																		
type	extension of MessageBody																		
properties	base MessageBody																		
children	D2035_MainSPID D3027_MainMeterId D2036_SubSPID D3006_SubMeterId D3026_MeterNetworkAssociation D4006_EffectiveFrom																		
used by	elements MessagesType/T036.0_MeterNetworkAssociations/T036.0_MeterNetworkAssociationResponseMessagesType/T036.1_MeterNetworkAssociationNotification																		
attributes	<table border="1"> <thead> <tr> <th>Name</th> <th>Type</th> <th>Use</th> <th>Default</th> <th>Fixed</th> <th>annotation</th> </tr> </thead> <tbody> <tr> <td>MID</td> <td>MessageIdType</td> <td>required</td> <td></td> <td></td> <td></td> </tr> <tr> <td>RelatedMID</td> <td>MessageIdType</td> <td>optional</td> <td></td> <td></td> <td></td> </tr> </tbody> </table>	Name	Type	Use	Default	Fixed	annotation	MID	MessageIdType	required				RelatedMID	MessageIdType	optional			
Name	Type	Use	Default	Fixed	annotation														
MID	MessageIdType	required																	
RelatedMID	MessageIdType	optional																	
annotation	documentation																		
source	<pre><xs:complexType name="MeterNetworkAssociationType"> <xs:annotation> <xs:documentation> </xs:documentation> </xs:annotation> <xs:complexContent> <xs:extension base="MessageBody"></pre>																		

```
<xs:sequence>
  <xs:element ref="D2035_MainSPID"/>
  <xs:element ref="D3027_MainMeterId"/>
  <xs:element ref="D2036_SubSPID" minOccurs="0"/>
  <xs:element ref="D3006_SubMeterId"/>
  <xs:element ref="D3026_MeterNetworkAssociation"/>
  <xs:element ref="D4006_EffectiveFrom"/>
</xs:sequence>
</xs:extension>
</xs:complexContent>
</xs:complexType>
```

complexType **MeterReadNotificationType**

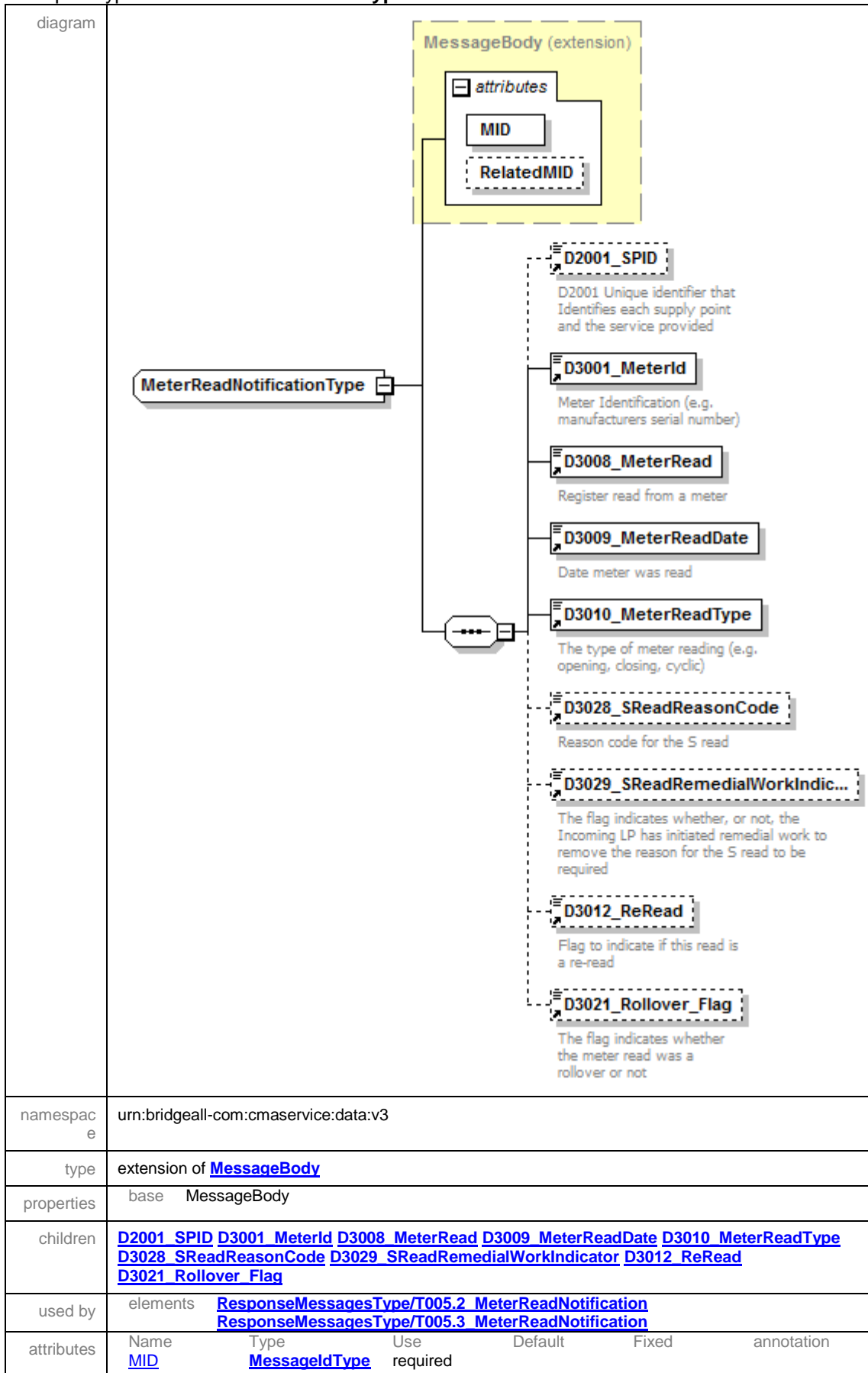

	RelatedMID MessageIdType optional
annotation	documentation
source	<pre> <xs:complexType name="MeterReadNotificationType"> <xs:annotation> <xs:documentation> </xs:documentation> </xs:annotation> <xs:complexContent> <xs:extension base="MessageBody"> <xs:sequence> <xs:element ref="D2001_SPID" minOccurs="0"/> <xs:element ref="D3001_MeterId"/> <xs:element ref="D3008_MeterRead"/> <xs:element ref="D3009_MeterReadDate"/> <xs:element ref="D3010_MeterReadType"/> <xs:element ref="D3028_SReadReasonCode" minOccurs="0"/> <xs:element ref="D3029_SReadRemedialWorkIndicator" minOccurs="0"/> <xs:element ref="D3012_ReRead" minOccurs="0"/> <xs:element ref="D3021_Rollover_Flag" minOccurs="0"/> </xs:sequence> </xs:extension> </xs:complexContent> </xs:complexType> </pre>

complexType **MeterReadType**

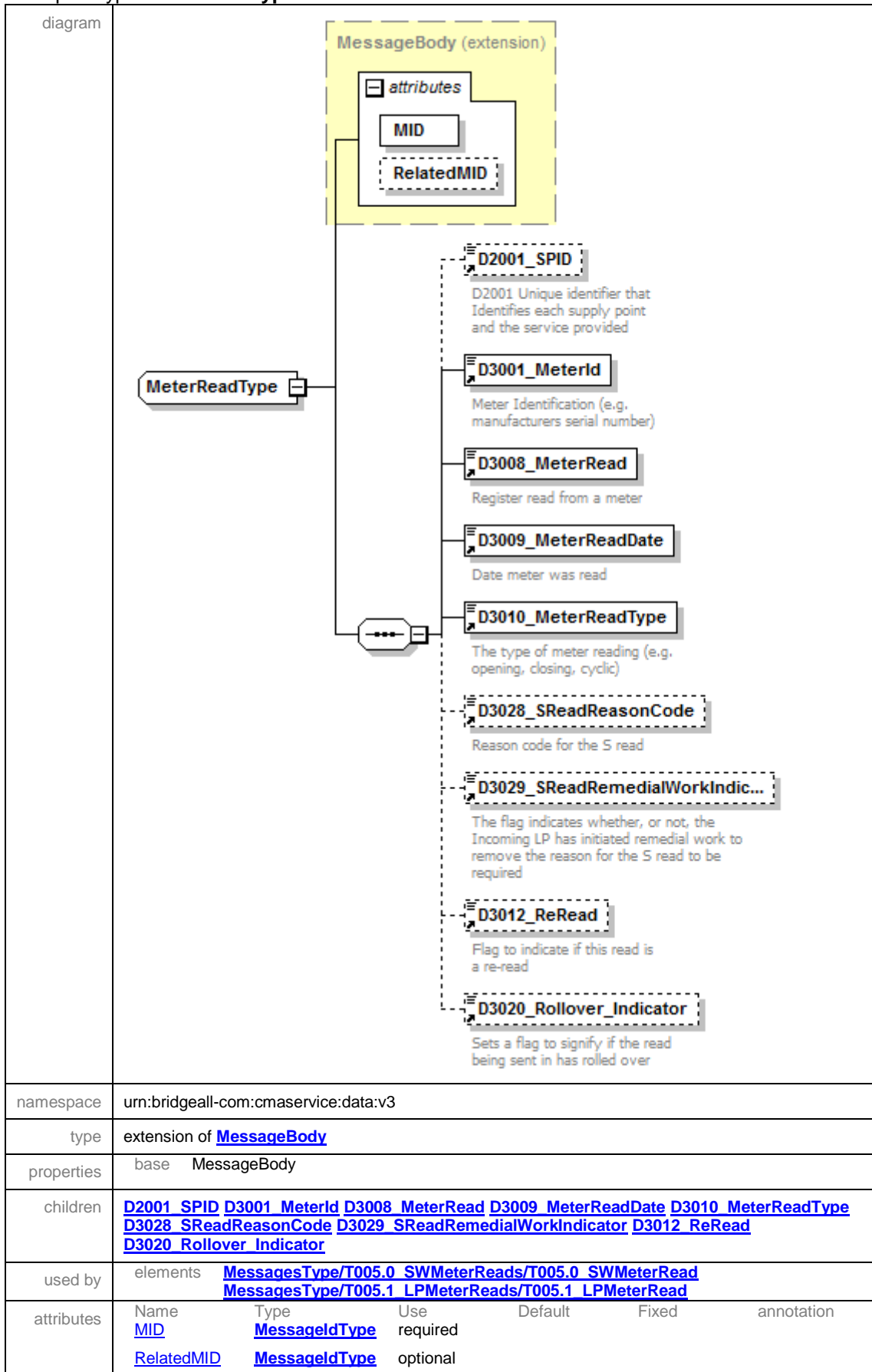

annotation	documentation
source	<pre> <xs:complexType name="MeterReadType"> <xs:annotation> <xs:documentation> </xs:documentation> </xs:annotation> <xs:complexContent> <xs:extension base="MessageBody"> <xs:sequence> <xs:element ref="D2001_SPID" minOccurs="0"/> <xs:element ref="D3001_MeterId"/> <xs:element ref="D3008_MeterRead"/> <xs:element ref="D3009_MeterReadDate"/> <xs:element ref="D3010_MeterReadType"/> <xs:element ref="D3028_SReadReasonCode" minOccurs="0"/> <xs:element ref="D3029_SReadRemedialWorkIndicator" minOccurs="0"/> <xs:element ref="D3012_ReRead" minOccurs="0"/> <xs:element ref="D3020_Rollover_Indicator" minOccurs="0"/> </xs:sequence> </xs:extension> </xs:complexContent> </xs:complexType> </pre>

complexType MeterSWAPDetailsNotificationType

diagram	<p> D3001_MeterId Meter Identification (e.g. manufacturers serial number) </p> <p> D3008_MeterRead Register read from a meter </p> <p> D3009_MeterReadDate Date meter was read </p> <p> D3010_MeterReadType The type of meter reading (e.g. opening, closing, cyclic) </p> <p> D3021_Rollover_Flag The flag indicates whether the meter read was a rollover or not </p>
namespace	urn:bridgeall-com:cmaservice:data:v3
children	D3001_MeterId D3008_MeterRead D3009_MeterReadDate D3010_MeterReadType D3021_Rollover_Flag
used by	elements MeterSwapNotificationType/NewMeter MeterSwapNotificationType/OldMeter
source	<pre> <xs:complexType name="MeterSWAPDetailsNotificationType"> <xs:sequence> <xs:element ref="D3001_MeterId"/> <xs:element ref="D3008_MeterRead"/> <xs:element ref="D3009_MeterReadDate"/> <xs:element ref="D3010_MeterReadType"/> </xs:sequence> </xs:complexType> </pre>

	<pre><xs:element ref="D3021_Rollover_Flag" minOccurs="0"/> </xs:sequence> </xs:complexType></pre>
--	---

complexType **MeterSWAPDetailsType**

diagram	
namespace	urn:bridgeall-com:cmaservice:data:v3
children	D3001_MeterId D3008_MeterRead D3009_MeterReadDate D3010_MeterReadType D3020_Rollover_Indicator
used by	elements MeterSwapType/NewMeter MeterSwapType/OldMeter
source	<pre><xs:complexType name="MeterSWAPDetailsType"> <xs:sequence> <xs:element ref="D3001_MeterId"/> <xs:element ref="D3008_MeterRead"/> <xs:element ref="D3009_MeterReadDate"/> <xs:element ref="D3010_MeterReadType"/> <xs:element ref="D3020_Rollover_Indicator" minOccurs="0"/> </xs:sequence> </xs:complexType></pre>

complexType MeterSwapNotificationType

diagram																			
namespace	urn:bridgeall-com:cmaservice:data:v3																		
type	extension of MessageBody																		
properties	base MessageBody																		
children	D2001_SPID NewMeter OldMeter D3012_ReRead																		
used by	element ResponseMessagesType/T017.1 MeterSwapNotification																		
attributes	<table border="1"> <thead> <tr> <th>Name</th> <th>Type</th> <th>Use</th> <th>Default</th> <th>Fixed</th> <th>annotation</th> </tr> </thead> <tbody> <tr> <td>MID</td> <td>MessageIdType</td> <td>required</td> <td></td> <td></td> <td></td> </tr> <tr> <td>RelatedMID</td> <td>MessageIdType</td> <td>optional</td> <td></td> <td></td> <td></td> </tr> </tbody> </table>	Name	Type	Use	Default	Fixed	annotation	MID	MessageIdType	required				RelatedMID	MessageIdType	optional			
Name	Type	Use	Default	Fixed	annotation														
MID	MessageIdType	required																	
RelatedMID	MessageIdType	optional																	
annotation	documentation																		
source	<pre> <xs:complexType name="MeterSwapNotificationType"> <xs:annotation> <xs:documentation> </xs:documentation> </xs:annotation> <xs:complexContent> <xs:extension base="MessageBody"> <xs:sequence> <xs:element ref="D2001_SPID" minOccurs="0"/> <xs:element name="NewMeter" type="MeterSWAPDetailsNotificationType"/> <xs:element name="OldMeter" type="MeterSWAPDetailsNotificationType"/> <xs:element ref="D3012_ReRead"/> </xs:sequence> </xs:extension> </xs:complexContent> </xs:complexType> </pre>																		

element **MeterSwapNotificationType/NewMeter**

diagram	<p>MeterSWAPDetailsNotificationType</p> <ul style="list-style-type: none"> D3001_MeterId Meter Identification (e.g. manufacturers serial number) D3008_MeterRead Register read from a meter D3009_MeterReadDate Date meter was read D3010_MeterReadType The type of meter reading (e.g. opening, closing, cyclic) D3021_Rollover_Flag The flag indicates whether the meter read was a rollover or not
namespace	urn:bridgeall-com:cmaservice:data:v3
type	MeterSWAPDetailsNotificationType
properties	isRef 0 content complex
children	D3001_MeterId D3008_MeterRead D3009_MeterReadDate D3010_MeterReadType D3021_Rollover_Flag
source	<code><xs:element name="NewMeter" type="MeterSWAPDetailsNotificationType"/></code>

element **MeterSwapNotificationType/OldMeter**

diagram	<p>MeterSWAPDetailsNotificationType</p> <ul style="list-style-type: none"> D3001_MeterId Meter Identification (e.g. manufacturers serial number) D3008_MeterRead Register read from a meter D3009_MeterReadDate Date meter was read D3010_MeterReadType The type of meter reading (e.g. opening, closing, cyclic) D3021_Rollover_Flag The flag indicates whether the meter read was a rollover or not
namespace	urn:bridgeall-com:cmaservice:data:v3

type	MeterSWAPDetailsNotificationType
properties	isRef 0 content complex
children	D3001_MeterId D3008_MeterRead D3009_MeterReadDate D3010_MeterReadType D3021_Rollover_Flag
source	<xs:element name="OldMeter" type="MeterSWAPDetailsNotificationType"/>

complexType MeterSwapType

diagram																			
namespace	urn:bridgeall-com:cmaservice:data:v3																		
type	extension of MessageBody																		
properties	base MessageBody																		
children	D2001_SPID NewMeter OldMeter D3012_ReRead																		
used by	element MessagesType/T017.0 MeterSwaps/T017.0 MeterSwap																		
attributes	<table border="1"> <thead> <tr> <th>Name</th> <th>Type</th> <th>Use</th> <th>Default</th> <th>Fixed</th> <th>annotation</th> </tr> </thead> <tbody> <tr> <td>MID</td> <td>MessageIdType</td> <td>required</td> <td></td> <td></td> <td></td> </tr> <tr> <td>RelatedMID</td> <td>MessageIdType</td> <td>optional</td> <td></td> <td></td> <td></td> </tr> </tbody> </table>	Name	Type	Use	Default	Fixed	annotation	MID	MessageIdType	required				RelatedMID	MessageIdType	optional			
Name	Type	Use	Default	Fixed	annotation														
MID	MessageIdType	required																	
RelatedMID	MessageIdType	optional																	
annotation	documentation																		
source	<pre><xs:complexType name="MeterSwapType"> <xs:annotation> <xs:documentation> </xs:documentation> </xs:annotation> <xs:complexContent> <xs:extension base="MessageBody"> <xs:sequence> <xs:element ref="D2001_SPID" minOccurs="0"/> <xs:element name="NewMeter" type="MeterSWAPDetailsType"/> <xs:element name="OldMeter" type="MeterSWAPDetailsType"/> <xs:element ref="D3012_ReRead"/> </xs:sequence> </xs:extension> </xs:complexContent> </xs:complexType></pre>																		

	<pre> </xs:sequence> </xs:extension> </xs:complexContent> </xs:complexType> </pre>
--	--

element **MeterSwapType/NewMeter**

diagram	<p>The diagram illustrates the structure of the NewMeter element. It is a complex type that contains five child elements:</p> <ul style="list-style-type: none"> D3001_MeterId: Meter Identification (e.g. manufacturers serial number) D3008_MeterRead: Register read from a meter D3009_MeterReadDate: Date meter was read D3010_MeterReadType: The type of meter reading (e.g. opening, closing, cyclic) D3020_Rollover_Indicator: Sets a flag to signify if the read being sent in has rolled over (shown as optional in the diagram) <p>The entire structure is enclosed in a dashed box labeled MeterSWAPDetails Type.</p>
namespace	urn:bridgeall-com:cmaservice:data:v3
type	MeterSWAPDetailsType
properties	isRef 0 content complex
children	D3001_MeterId D3008_MeterRead D3009_MeterReadDate D3010_MeterReadType D3020_Rollover_Indicator
source	<code><xs:element name="NewMeter" type="MeterSWAPDetailsType"/></code>

element **MeterSwapType/OldMeter**

<p>diagram</p>	<p>The diagram illustrates the structure of the OldMeter element. It is a container for a MeterSWAPDetailsType complex type. The MeterSWAPDetailsType contains five child elements:</p> <ul style="list-style-type: none"> D3001_MeterId: Meter Identification (e.g. manufacturers serial number) D3008_MeterRead: Register read from a meter D3009_MeterReadDate: Date meter was read D3010_MeterReadType: The type of meter reading (e.g. opening, closing, cyclic) D3020_Rollover_Indicator: Sets a flag to signify if the read being sent in has rolled over
<p>namespace</p>	<p>urn:bridgeall-com:cmaservice:data:v3</p>
<p>type</p>	<p>MeterSWAPDetailsType</p>
<p>properties</p>	<p>isRef 0 content complex</p>
<p>children</p>	<p>D3001_MeterId D3008_MeterRead D3009_MeterReadDate D3010_MeterReadType D3020_Rollover_Indicator</p>
<p>source</p>	<p><code><xs:element name="OldMeter" type="MeterSWAPDetailsType"/></code></p>

complexType MeterUpdateNotificationType

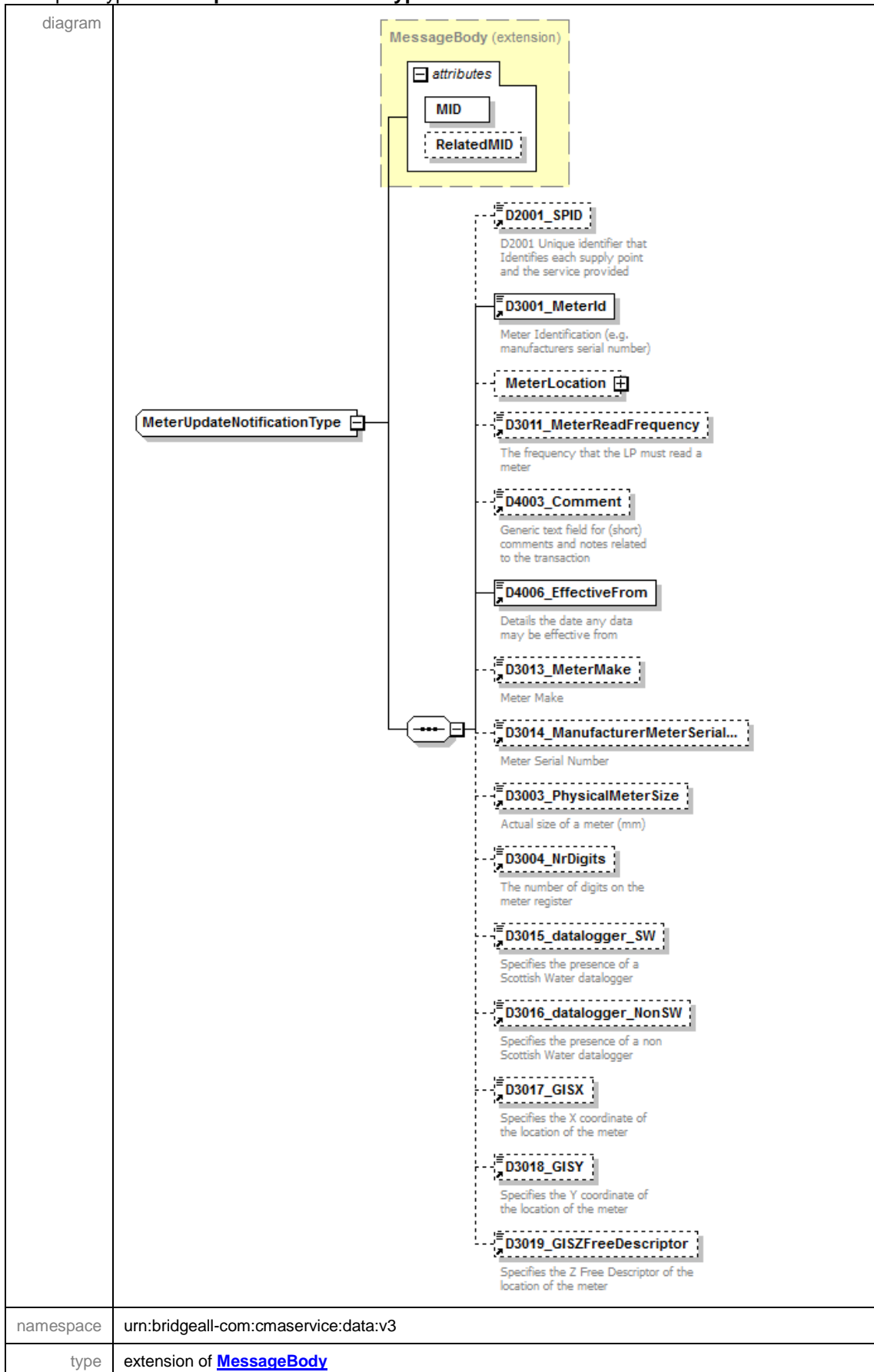

properties	base MessageBody																		
children	D2001_SPID D3001_MeterId MeterLocation D3011_MeterReadFrequency D4003_Comment D4006_EffectiveFrom D3013_MeterMake D3014_ManufacturerMeterSerialNr D3003_PhysicalMeterSize D3004_NrDigits D3015_datalogger_SW D3016_datalogger_NonSW D3017_GISX D3018_GISY D3019_GISZFreeDescriptor																		
used by	element ResponseMessagesType/T013.1_MeterUpdate																		
attributes	<table border="1"> <thead> <tr> <th>Name</th> <th>Type</th> <th>Use</th> <th>Default</th> <th>Fixed</th> <th>annotation</th> </tr> </thead> <tbody> <tr> <td>MID</td> <td>MessageIdType</td> <td>required</td> <td></td> <td></td> <td></td> </tr> <tr> <td>RelatedMID</td> <td>MessageIdType</td> <td>optional</td> <td></td> <td></td> <td></td> </tr> </tbody> </table>	Name	Type	Use	Default	Fixed	annotation	MID	MessageIdType	required				RelatedMID	MessageIdType	optional			
Name	Type	Use	Default	Fixed	annotation														
MID	MessageIdType	required																	
RelatedMID	MessageIdType	optional																	
annotation	documentation																		
source	<pre> <xs:complexType name="MeterUpdateNotificationType"> <xs:annotation> <xs:documentation> </xs:documentation> </xs:annotation> <xs:complexContent> <xs:extension base="MessageBody"> <xs:sequence> <xs:element ref="D2001_SPID" minOccurs="0"/> <xs:element ref="D3001_MeterId"/> <xs:element name="MeterLocation" type="AddressType" minOccurs="0"/> <xs:element ref="D3011_MeterReadFrequency" minOccurs="0"/> <xs:element ref="D4003_Comment" minOccurs="0"/> <xs:element ref="D4006_EffectiveFrom"/> <xs:element ref="D3013_MeterMake" minOccurs="0"/> <xs:element ref="D3014_ManufacturerMeterSerialNr" minOccurs="0"/> <xs:element ref="D3003_PhysicalMeterSize" minOccurs="0"/> <xs:element ref="D3004_NrDigits" minOccurs="0"/> <xs:element ref="D3015_datalogger_SW" minOccurs="0"/> <xs:element ref="D3016_datalogger_NonSW" minOccurs="0"/> <xs:element ref="D3017_GISX" minOccurs="0"/> <xs:element ref="D3018_GISY" minOccurs="0"/> <xs:element ref="D3019_GISZFreeDescriptor" minOccurs="0"/> </xs:sequence> </xs:extension> </xs:complexContent> </xs:complexType> </pre>																		

element **MeterUpdateNotificationType/MeterLocation**

<p>diagram</p>	
<p>namespace</p>	<p>urn:bridgeall-com:cmaservice:data:v3</p>
<p>type</p>	<p>AddressType</p>
<p>properties</p>	<p>isRef 0 minOcc 0 maxOcc 1 content complex</p>
<p>children</p>	<p>D5001_FreeDescriptor D5002_SubBuildingName D5003_BuildingName D5004_BuildingNumber D5005_DependentThoroughfareName D5006_DependentThoroughfareDescriptor D5007_ThoroughfareName D5008_ThoroughfareDescriptor D5009_DoubleDependentLocality D5010_DependentLocality D5011_PostTown D5012_County D5013_Postcode</p>
<p>source</p>	<p><xs:element name="MeterLocation" type="AddressType" minOccurs="0"/></p>

complexType **MeterUpdateType**

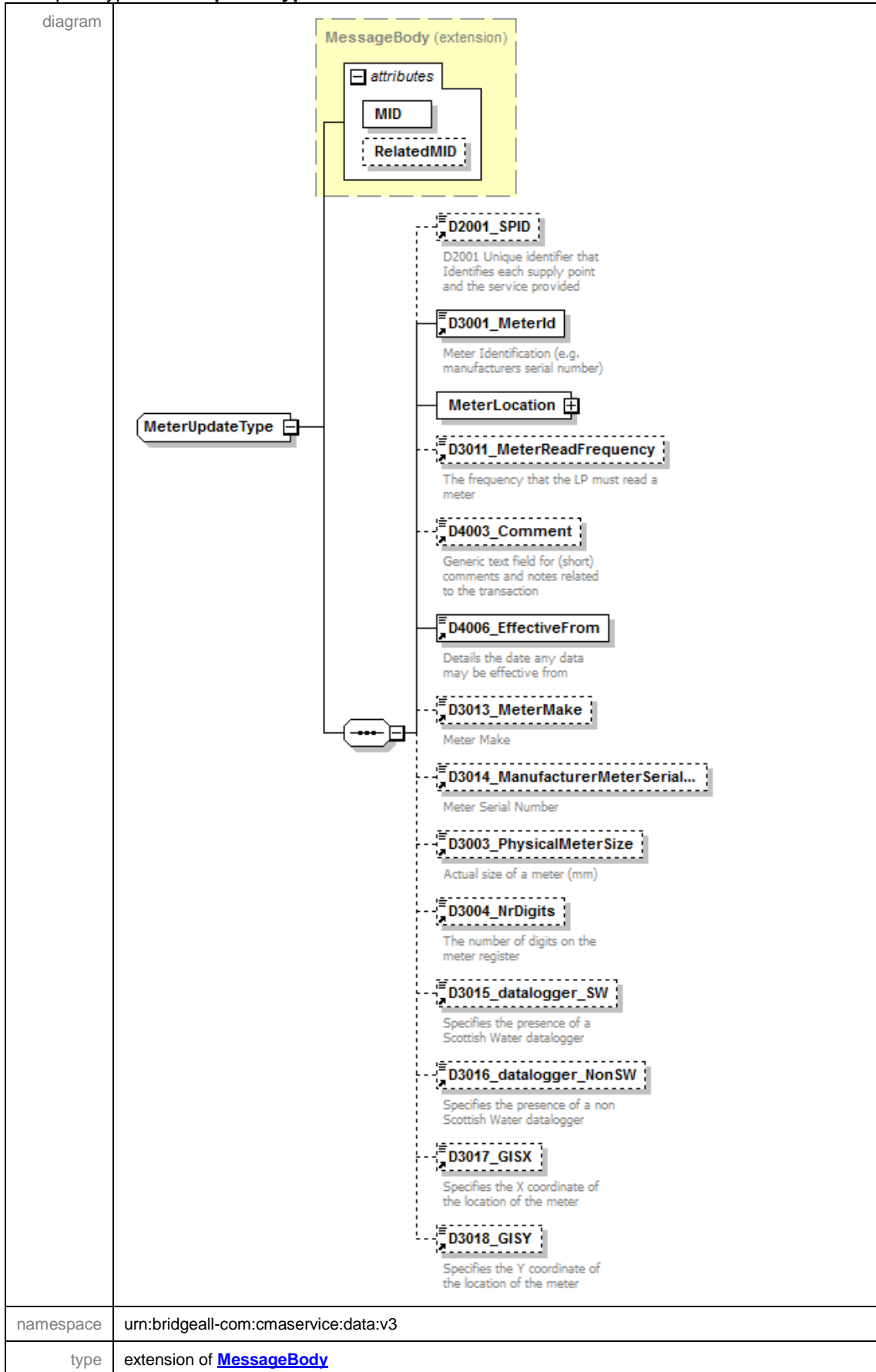

properties	base MessageBody																		
children	D2001_SPID D3001_MeterId MeterLocation D3011_MeterReadFrequency D4003_Comment D4006_EffectiveFrom D3013_MeterMake D3014_ManufacturerMeterSerialNr D3003_PhysicalMeterSize D3004_NrDigits D3015_datalogger_SW D3016_datalogger_NonSW D3017_GISX D3018_GISY																		
used by	element MessagesType/T013.0_MeterUpdates/T013.0_MeterUpdate																		
attributes	<table border="1"> <thead> <tr> <th>Name</th> <th>Type</th> <th>Use</th> <th>Default</th> <th>Fixed</th> <th>annotation</th> </tr> </thead> <tbody> <tr> <td>MID</td> <td>MessageIdType</td> <td>required</td> <td></td> <td></td> <td></td> </tr> <tr> <td>RelatedMID</td> <td>MessageIdType</td> <td>optional</td> <td></td> <td></td> <td></td> </tr> </tbody> </table>	Name	Type	Use	Default	Fixed	annotation	MID	MessageIdType	required				RelatedMID	MessageIdType	optional			
Name	Type	Use	Default	Fixed	annotation														
MID	MessageIdType	required																	
RelatedMID	MessageIdType	optional																	
annotation	documentation																		
source	<pre> <xs:complexType name="MeterUpdateType"> <xs:annotation> <xs:documentation> </xs:documentation> </xs:annotation> <xs:complexContent> <xs:extension base="MessageBody"> <xs:sequence> <xs:element ref="D2001_SPID" minOccurs="0"/> <xs:element ref="D3001_MeterId"/> <xs:element name="MeterLocation" type="AddressType"/> <xs:element ref="D3011_MeterReadFrequency" minOccurs="0"/> <xs:element ref="D4003_Comment" minOccurs="0"/> <xs:element ref="D4006_EffectiveFrom"/> <xs:element ref="D3013_MeterMake" minOccurs="0"/> <xs:element ref="D3014_ManufacturerMeterSerialNr" minOccurs="0"/> <xs:element ref="D3003_PhysicalMeterSize" minOccurs="0"/> <xs:element ref="D3004_NrDigits" minOccurs="0"/> <xs:element ref="D3015_datalogger_SW" minOccurs="0"/> <xs:element ref="D3016_datalogger_NonSW" minOccurs="0"/> <xs:element ref="D3017_GISX" minOccurs="0"/> <xs:element ref="D3018_GISY" minOccurs="0"/> </xs:sequence> </xs:extension> </xs:complexContent> </xs:complexType> </pre>																		

element **MeterUpdateType/MeterLocation**

<p>diagram</p>	
<p>namespace</p>	<p>urn:bridgeall-com:cmaservice:data:v3</p>
<p>type</p>	<p>AddressType</p>
<p>properties</p>	<p>isRef 0 content complex</p>
<p>children</p>	<p>D5001_FreeDescriptor D5002_SubBuildingName D5003_BuildingName D5004_BuildingNumber D5005_DependentThoroughfareName D5006_DependentThoroughfareDescriptor D5007_ThoroughfareName D5008_ThoroughfareDescriptor D5009_DoubleDependentLocality D5010_DependentLocality D5011_PostTown D5012_County D5013_Postcode</p>
<p>source</p>	<p><xs:element name="MeterLocation" type="AddressType"/></p>

complexType NewLPSPIDNotificationType

diagram	<p>The diagram illustrates the structure of the NewLPSPIDNotificationType complex type. It is an extension of the MessageBody type. The MessageBody extension contains an attributes container with two attributes: MID (required) and RelatedMID (optional). The NewLPSPIDNotificationType contains a sequence of elements: D2001_SPID (required), Address (required), UARNDData (optional), UPRNDData (optional), D2009_SWConnectionRef (required), D2023_NewConnectionType (required), and D2034_AllocationMethod (required). Each element has a brief description: D2001_SPID is a unique identifier for supply points and services; Address is the connection address; UARNDData and UPRNDData are unique identifiers for wholesalers; D2009_SWConnectionRef is a unique reference for new connections; D2023_NewConnectionType is the connection type; and D2034_AllocationMethod is the allocation method.</p>																		
namespace	urn:bridgeall-com:cmaservice:data:v3																		
type	extension of MessageBody																		
properties	base MessageBody																		
children	D2001_SPID Address UARNDData UPRNDData D2009_SWConnectionRef D2023_NewConnectionType D2034_AllocationMethod																		
used by	element ResponseMessagesType/T002.0 NewSPIDNotification																		
attributes	<table border="1"> <thead> <tr> <th>Name</th> <th>Type</th> <th>Use</th> <th>Default</th> <th>Fixed</th> <th>annotation</th> </tr> </thead> <tbody> <tr> <td>MID</td> <td>MessageIdType</td> <td>required</td> <td></td> <td></td> <td></td> </tr> <tr> <td>RelatedMID</td> <td>MessageIdType</td> <td>optional</td> <td></td> <td></td> <td></td> </tr> </tbody> </table>	Name	Type	Use	Default	Fixed	annotation	MID	MessageIdType	required				RelatedMID	MessageIdType	optional			
Name	Type	Use	Default	Fixed	annotation														
MID	MessageIdType	required																	
RelatedMID	MessageIdType	optional																	
annotation	documentation																		
source	<pre><xs:complexType name="NewLPSPIDNotificationType"> <xs:annotation> <xs:documentation> </xs:documentation> </xs:annotation> <xs:complexContent> <xs:extension base="MessageBody"> <xs:sequence> <xs:element ref="D2001_SPID"/> <xs:element name="Address" type="AddressType"/> <xs:element name="UARNDData" type="UARNTYPE" minOccurs="0"/> <xs:element name="UPRNDData" type="UPRNTYPE" minOccurs="0"/> </xs:sequence> </xs:extension> </xs:complexContent> </xs:complexType></pre>																		

```

<xs:element ref="D2009_SWConnectionRef"/>
<xs:element ref="D2023_NewConnectionType"/>
<xs:element ref="D2034_AllocationMethod"/>
</xs:sequence>
</xs:extension>
</xs:complexContent>
</xs:complexType>

```

element **NewLPSPIDNotificationType/Address**

diagram	
namespace	urn:bridgeall-com:cmaservice:data:v3
type	AddressType
properties	isRef 0 content complex
children	D5001_FreeDescriptor D5002_SubBuildingName D5003_BuildingName D5004_BuildingNumber D5005_DependentThoroughfareName D5006_DependentThoroughfareDescriptor D5007_ThoroughfareName D5008_ThoroughfareDescriptor D5009_DoubleDependentLocality D5010_DependentLocality D5011_PostTown D5012_County D5013_Postcode
source	<xs:element name="Address" type="AddressType"/>

element **NewLPSPIDNotificationType/UARNDData**

diagram	<p>The diagram illustrates the structure of the UARNDData element. It is represented as a dashed box on the left, connected by a line to a central octagonal connector. This connector is linked to a larger dashed box on the right labeled 'UARNType'. Inside the 'UARNType' box, two child elements are shown: 'D2037_SAAReferenceNumber' and 'D2038_SAAReferenceNumberAbsenceCode', both enclosed in dashed boxes.</p>
namespace	urn:bridgeall-com:cmaservice:data:v3
type	UARNType
properties	isRef 0 minOcc 0 maxOcc 1 content complex
children	D2037_SAAReferenceNumber D2038_SAAReferenceNumberAbsenceCode
source	<code><xs:element name="UARNDData" type="UARNType" minOccurs="0"/></code>

element **NewLPSPIDNotificationType/UPRNDData**

diagram	<p>The diagram illustrates the structure of the UPRNDData element. It is represented as a dashed box on the left, connected by a line to a central octagonal connector. This connector is linked to a larger dashed box on the right labeled 'UPRNType'. Inside the 'UPRNType' box, two child elements are shown: 'D2039_UPRN' and 'D2040_UPRNAbsenceCode', both enclosed in dashed boxes.</p>
namespace	urn:bridgeall-com:cmaservice:data:v3
type	UPRNType
properties	isRef 0 minOcc 0 maxOcc 1 content complex
children	D2039_UPRN D2040_UPRNAbsenceCode
source	<code><xs:element name="UPRNDData" type="UPRNType" minOccurs="0"/></code>

complexType **NewSPIDNotificationType**

<p>diagram</p>																			
<p>namespace</p>	<p>urn:bridgeall-com:cmaservice:data:v3</p>																		
<p>type</p>	<p>extension of MessageBody</p>																		
<p>properties</p>	<p>base MessageBody</p>																		
<p>children</p>	<p>D2001_SPID Address UARNDData UPRNDData D2009_SWConnectionRef D2023_NewConnectionType D2034_AllocationMethod D4001_OrgId</p>																		
<p>used by</p>	<p>element ResponseMessagesType/T002.1 NewSPIDNotification</p>																		
<p>attributes</p>	<table border="1"> <thead> <tr> <th>Name</th> <th>Type</th> <th>Use</th> <th>Default</th> <th>Fixed</th> <th>annotation</th> </tr> </thead> <tbody> <tr> <td>MID</td> <td>MessageIdType</td> <td>required</td> <td></td> <td></td> <td></td> </tr> <tr> <td>RelatedMID</td> <td>MessageIdType</td> <td>optional</td> <td></td> <td></td> <td></td> </tr> </tbody> </table>	Name	Type	Use	Default	Fixed	annotation	MID	MessageIdType	required				RelatedMID	MessageIdType	optional			
Name	Type	Use	Default	Fixed	annotation														
MID	MessageIdType	required																	
RelatedMID	MessageIdType	optional																	
<p>annotation</p>	<p>documentation</p>																		
<p>source</p>	<pre><xs:complexType name="NewSPIDNotificationType"> <xs:annotation> <xs:documentation> </xs:documentation> </xs:annotation> <xs:complexContent></pre>																		

```

<xs:extension base="MessageBody">
  <xs:sequence>
    <xs:element ref="D2001_SPID"/>
    <xs:element name="Address" type="AddressType"/>
    <xs:element name="UARNDData" type="UARNTYPE" minOccurs="0"/>
    <xs:element name="UPRNDData" type="UPRNTYPE" minOccurs="0"/>
    <xs:element ref="D2009_SWConnectionRef"/>
    <xs:element ref="D2023_NewConnectionType"/>
    <xs:element ref="D2034_AllocationMethod"/>
    <xs:element ref="D4001_OrgId"/>
  </xs:sequence>
</xs:extension>
</xs:complexContent>
</xs:complexType>

```

element **NewSPIDNotificationType/Address**

diagram	
namespace	urn:bridgeall-com:cmaservice:data:v3
type	AddressType
properties	isRef 0 content complex
children	D5001_FreeDescriptor D5002_SubBuildingName D5003_BuildingName D5004_BuildingNumber D5005_DependentThoroughfareName D5006_DependentThoroughfareDescriptor D5007_ThoroughfareName D5008_ThoroughfareDescriptor D5009_DoubleDependentLocality D5010_DependentLocality D5011_PostTown D5012_County D5013_Postcode
source	<xs:element name="Address" type="AddressType"/>

element **NewSPIDNotificationType/UARNDData**

diagram	<p>The diagram illustrates the structure of the UARNDData element. It is a dashed box containing a solid box labeled UARNTType. Inside UARNTType, there are two dashed boxes representing child elements: D2037_SAAReferenceNumber and D2038_SAAReferenceNumberAbsenceCode. The UARNDData element is connected to the UARNTType element via a line with a small square at the end, indicating a containment relationship.</p>
namespace	urn:bridgeall-com:cmaservice:data:v3
type	UARNTType
properties	isRef 0 minOcc 0 maxOcc 1 content complex
children	D2037_SAAReferenceNumber D2038_SAAReferenceNumberAbsenceCode
source	<code><xs:element name="UARNDData" type="UARNTType" minOccurs="0"/></code>

element **NewSPIDNotificationType/UPRNDData**

diagram	<p>The diagram illustrates the structure of the UPRNDData element. It is a dashed box containing a solid box labeled UPRNTType. Inside UPRNTType, there are two dashed boxes representing child elements: D2039_UPRN and D2040_UPRNAbsenceCode. The UPRNDData element is connected to the UPRNTType element via a line with a small square at the end, indicating a containment relationship.</p>
namespace	urn:bridgeall-com:cmaservice:data:v3
type	UPRNTType
properties	isRef 0 minOcc 0 maxOcc 1 content complex
children	D2039_UPRN D2040_UPRNAbsenceCode
source	<code><xs:element name="UPRNDData" type="UPRNTType" minOccurs="0"/></code>

complexType NewSPIDRequestType

diagram																			
namespace	urn:bridgeall-com:cmaservice:data:v3																		
type	extension of MessageBody																		
properties	base MessageBody																		
children	D2001_SPID D2009_SWConnectionRef D4001_OrgId D2002_ServiceCategory SPIDLocation D2023_NewConnectionType UARNDData UPRNDData																		
used by	element MessagesType/T001.0 NewSPIDRequests/T001.0 NewSPIDRequest																		
attributes	<table border="1"> <thead> <tr> <th>Name</th> <th>Type</th> <th>Use</th> <th>Default</th> <th>Fixed</th> <th>annotation</th> </tr> </thead> <tbody> <tr> <td>MID</td> <td>MessageIdType</td> <td>required</td> <td></td> <td></td> <td></td> </tr> <tr> <td>RelatedMID</td> <td>MessageIdType</td> <td>optional</td> <td></td> <td></td> <td></td> </tr> </tbody> </table>	Name	Type	Use	Default	Fixed	annotation	MID	MessageIdType	required				RelatedMID	MessageIdType	optional			
Name	Type	Use	Default	Fixed	annotation														
MID	MessageIdType	required																	
RelatedMID	MessageIdType	optional																	
annotation	documentation																		
source	<pre><xs:complexType name="NewSPIDRequestType"> <xs:annotation> <xs:documentation> </xs:documentation> </xs:annotation> <xs:complexContent> <xs:extension base="MessageBody"> <xs:sequence></pre>																		

	<pre> <xs:element ref="D2001_SPID" minOccurs="0"/> <xs:element ref="D2009_SWConnectionRef"/> <xs:element ref="D4001_OrgId" minOccurs="0"/> <xs:element name="D2002_ServiceCategory" type="ServiceCategoryType"/> <xs:element name="SPIDLocation" type="AddressType"/> <xs:element ref="D2023_NewConnectionType"/> <xs:element name="UARNDData" type="UARNTYPE" minOccurs="0"/> <xs:element name="UPRNDData" type="UPRNType" minOccurs="0"/> </xs:sequence> </xs:extension> </xs:complexContent> </xs:complexType> </pre>
--	--

element NewSPIDRequestType/D2002_ServiceCategory

diagram										
namespace	urn:bridgeall-com:cmaservice:data:v3									
type	ServiceCategoryType									
properties	isRef 0 content simple									
facets	<table border="1"> <thead> <tr> <th>Kind</th> <th>Value</th> <th>annotation</th> </tr> </thead> <tbody> <tr> <td>enumeration</td> <td>01</td> <td></td> </tr> <tr> <td>enumeration</td> <td>02</td> <td></td> </tr> </tbody> </table>	Kind	Value	annotation	enumeration	01		enumeration	02	
Kind	Value	annotation								
enumeration	01									
enumeration	02									
source	<pre><xs:element name="D2002_ServiceCategory" type="ServiceCategoryType"/></pre>									

element **NewSPIDRequestType/SPIDLocation**

<p>diagram</p>	
<p>namespace</p>	<p>urn:bridgeall-com:cmaservice:data:v3</p>
<p>type</p>	<p>AddressType</p>
<p>properties</p>	<p>isRef 0 content complex</p>
<p>children</p>	<p>D5001_FreeDescriptor D5002_SubBuildingName D5003_BuildingName D5004_BuildingNumber D5005_DependentThoroughfareName D5006_DependentThoroughfareDescriptor D5007_ThoroughfareName D5008_ThoroughfareDescriptor D5009_DoubleDependentLocality D5010_DependentLocality D5011_PostTown D5012_County D5013_Postcode</p>
<p>source</p>	<p><xs:element name="SPIDLocation" type="AddressType"/></p>

element **NewSPIDRequestType/UARNData**

<p>diagram</p>	
<p>namespace</p>	<p>urn:bridgeall-com:cmaservice:data:v3</p>
<p>type</p>	<p>UARNTYPE</p>
<p>properties</p>	<p>isRef 0 minOcc 0 maxOcc 1</p>

	content complex
children	D2037_SAARefereceNumber D2038_SAARefereceNumberAbsenceCode
source	<xs:element name="UARNDData" type="UARNTType" minOccurs="0"/>

element NewSPIDRequestType/UPRNDData

diagram	
namespace	urn:bridgeall-com:cmaservice:data:v3
type	UPRNTType
properties	isRef 0 minOcc 0 maxOcc 1 content complex
children	D2039_UPRN D2040_UPRNBabsenceCode
source	<xs:element name="UPRNDData" type="UPRNTType" minOccurs="0"/>

complexType NotificationType

diagram	
namespace	urn:bridgeall-com:cmaservice:data:v3
type	extension of MessageBody
properties	base MessageBody
children	D1008_DataItemRef D4004_ReturnCode D2001_SPID
used by	elements ResponseMessagesType/T009.0_Notification ResponseMessagesType/T009.1_Notification MessagesType/T009.2_Notifications/T009.2_Notification MessagesType/T009.3_Notifications/T009.3_Notification

attributes	Name MID RelatedMID	Type MessageIdType MessageIdType	Use required optional	Default	Fixed	annotation
annotation	documentation					
source	<pre> <xs:complexType name="NotificationType"> <xs:annotation> <xs:documentation> </xs:documentation> </xs:annotation> <xs:complexContent> <xs:extension base="MessageBody"> <xs:sequence> <xs:element ref="D1008_DataItemRef" minOccurs="0"/> <xs:element ref="D4004_ReturnCode"/> <xs:element ref="D2001_SPID" minOccurs="0"/> </xs:sequence> </xs:extension> </xs:complexContent> </xs:complexType> </pre>					

complexType NotifyRSDType

diagram						
namespace	urn:bridgeall-com:cmaservice:data:v3					
type	extension of MessageBody					
properties	base MessageBody					
children	D2001_SPID D4001_Orqld D4002_RegistrationStartDate					
used by	element ResponseMessagesType/T008.2_NotifyRSD					
attributes	Name MID	Type MessageIdType	Use required	Default	Fixed	annotation

	RelatedMID MessageIdType optional
source	<pre> <xs:complexType name="NotifyRSdtype"> <xs:annotation> <xs:documentation/> </xs:annotation> <xs:complexContent> <xs:extension base="MessageBody"> <xs:sequence> <xs:element ref="D2001_SPID"/> <xs:element ref="D4001_OrgId"/> <xs:element ref="D4002_RegistrationStartDate"/> </xs:sequence> </xs:extension> </xs:complexContent> </xs:complexType> </pre>

complexType **PartialRegistrationApplicationType**

diagram						
namespace	urn:bridgeall-com:cmaservice:data:v3					
type	extension of MessageBody					
properties	base MessageBody					
children	D2001_SPID					
used by	element	MessagesType/T003.0 PartialRegistrationApplications/T003.0 PartialRegistrationApplication				
attributes	Name	Type	Use	Default	Fixed	annotation
	MID	MessageIdType	required			
	RelatedMID	MessageIdType	optional			
annotation	documentation T003.0					
source	<pre> <xs:complexType name="PartialRegistrationApplicationType"> <xs:annotation> <xs:documentation>T003.0</xs:documentation> </xs:annotation> <xs:complexContent> <xs:extension base="MessageBody"> <xs:sequence> <xs:element ref="D2001_SPID"/> </xs:sequence> </xs:extension> </xs:complexContent> </pre>					

	<code></xs:complexType></code>
--	--------------------------------------

complexType PostcodeType

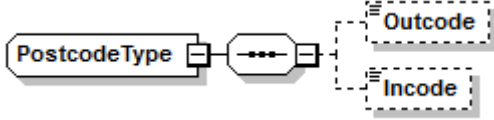
diagram	
namespace	urn:bridgeall-com:cmaservice:data:v3
children	Outcode Incode
used by	element AddressType/D5013 Postcode
source	<pre> <xs:complexType name="PostcodeType"> <xs:sequence> <xs:element name="Outcode" minOccurs="0"> <xs:simpleType> <xs:restriction base="xs:string"> <xs:maxLength value="4"/> <xs:whiteSpace value="preserve"/> <xs:pattern value="([A-Z][0-9])*"/> </xs:restriction> </xs:simpleType> </xs:element> <xs:element name="Incode" minOccurs="0"> <xs:simpleType> <xs:restriction base="xs:string"> <xs:maxLength value="3"/> <xs:whiteSpace value="preserve"/> <xs:pattern value="([A-Z][0-9])*"/> </xs:restriction> </xs:simpleType> </xs:element> </xs:sequence> </xs:complexType> </pre>

element PostcodeType/Outcode

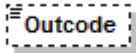
diagram													
namespace	urn:bridgeall-com:cmaservice:data:v3												
type	restriction of xs:string												
properties	<table border="0"> <tr><td>isRef</td><td>0</td></tr> <tr><td>minOcc</td><td>0</td></tr> <tr><td>maxOcc</td><td>1</td></tr> <tr><td>content</td><td>simple</td></tr> </table>	isRef	0	minOcc	0	maxOcc	1	content	simple				
isRef	0												
minOcc	0												
maxOcc	1												
content	simple												
facets	<table border="0"> <tr><td>Kind</td><td>Value</td><td>annotation</td></tr> <tr><td>maxLength</td><td>4</td><td></td></tr> <tr><td>whiteSpace</td><td>preserve</td><td></td></tr> <tr><td>pattern</td><td>(([A-Z][0-9])*)</td><td></td></tr> </table>	Kind	Value	annotation	maxLength	4		whiteSpace	preserve		pattern	(([A-Z][0-9])*)	
Kind	Value	annotation											
maxLength	4												
whiteSpace	preserve												
pattern	(([A-Z][0-9])*)												
source	<pre> <xs:element name="Outcode" minOccurs="0"> <xs:simpleType> <xs:restriction base="xs:string"> <xs:maxLength value="4"/> <xs:whiteSpace value="preserve"/> </xs:restriction> </xs:simpleType> </xs:element> </pre>												

	<pre> <xs:pattern value="([A-Z][0-9])*"/> </xs:restriction> </xs:simpleType> </xs:element> </pre>
--	---

element PostcodeType/Incode

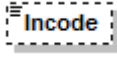
diagram													
namespace	urn:bridgeall-com:cmaservice:data:v3												
type	restriction of xs:string												
properties	<table> <tr><td>isRef</td><td>0</td></tr> <tr><td>minOcc</td><td>0</td></tr> <tr><td>maxOcc</td><td>1</td></tr> <tr><td>content</td><td>simple</td></tr> </table>	isRef	0	minOcc	0	maxOcc	1	content	simple				
isRef	0												
minOcc	0												
maxOcc	1												
content	simple												
facets	<table> <tr><td>Kind</td><td>Value</td><td>annotation</td></tr> <tr><td>maxLength</td><td>3</td><td></td></tr> <tr><td>whiteSpace</td><td>preserve</td><td></td></tr> <tr><td>pattern</td><td>(([A-Z][0-9])*</td><td></td></tr> </table>	Kind	Value	annotation	maxLength	3		whiteSpace	preserve		pattern	(([A-Z][0-9])*	
Kind	Value	annotation											
maxLength	3												
whiteSpace	preserve												
pattern	(([A-Z][0-9])*												
source	<pre> <xs:element name="Incode" minOccurs="0"> <xs:simpleType> <xs:restriction base="xs:string"> <xs:maxLength value="3"/> <xs:whiteSpace value="preserve"/> <xs:pattern value="([A-Z][0-9])*"/> </xs:restriction> </xs:simpleType> </xs:element> </pre>												

complexType **PremisesSpecialArrangementsUpdateNotificationType**

<p>diagram</p>																			
<p>namespace</p>	<p>urn:bridgeall-com:cmaservice:data:v3</p>																		
<p>type</p>	<p>extension of MessageBody</p>																		
<p>properties</p>	<p>base MessageBody</p>																		
<p>children</p>	<p>D2001_SPID D4006_EffectiveFrom D2004_ExemptCustomerFlag D2041_PcentExemption</p>																		
<p>used by</p>	<p>element ResponseMessagesType/T029.4_PremisesSpecialArrangementsUpdateNotification</p>																		
<p>attributes</p>	<table border="1"> <thead> <tr> <th>Name</th> <th>Type</th> <th>Use</th> <th>Default</th> <th>Fixed</th> <th>annotation</th> </tr> </thead> <tbody> <tr> <td>MID</td> <td>MessageIdType</td> <td>required</td> <td></td> <td></td> <td></td> </tr> <tr> <td>RelatedMID</td> <td>MessageIdType</td> <td>optional</td> <td></td> <td></td> <td></td> </tr> </tbody> </table>	Name	Type	Use	Default	Fixed	annotation	MID	MessageIdType	required				RelatedMID	MessageIdType	optional			
Name	Type	Use	Default	Fixed	annotation														
MID	MessageIdType	required																	
RelatedMID	MessageIdType	optional																	
<p>annotation</p>	<p>documentation</p>																		
<p>source</p>	<pre> <xs:complexType name="PremisesSpecialArrangementsUpdateNotificationType"> <xs:annotation> <xs:documentation> </xs:documentation> </xs:annotation> <xs:complexContent> <xs:extension base="MessageBody"> <xs:sequence> <xs:element ref="D2001_SPID"/> <xs:element ref="D4006_EffectiveFrom"/> <xs:element ref="D2004_ExemptCustomerFlag" minOccurs="0"/> <xs:element ref="D2041_PcentExemption" minOccurs="0"/> </xs:sequence> </xs:extension> </xs:complexContent> </xs:complexType> </pre>																		

complexType **PremisesSpecialArrangementsUpdateType**

diagram	<p>The diagram shows the structure of the PremisesSpecialArrangementsUpdateType complex type. It is an extension of the MessageBody type. The MessageBody extension contains an attributes container with two elements: MID (required) and RelatedMID (optional). The PremisesSpecialArrangementsUpdateType contains a sequence of four elements: D2001_SPID (required), D4006_EffectiveFrom (required), D2004_ExemptCustomerFlag (optional), and D2041_PcentExemption (optional). Each element has a description: D2001_SPID is a unique identifier for supply points and services; D4006_EffectiveFrom is the date data becomes effective; D2004_ExemptCustomerFlag is a Scottish Executive Exempt Scheme flag; and D2041_PcentExemption is the percentage of the exempt customer flag that is applied.</p>																		
namespace	urn:bridgeall-com:cmaservice:data:v3																		
type	extension of MessageBody																		
properties	base MessageBody																		
children	D2001_SPID D4006_EffectiveFrom D2004_ExemptCustomerFlag D2041_PcentExemption																		
used by	element MessagesType/T029.3 PremisesSpecialArrangementsUpdates/T029.3 PremisesSpecialArrangementsUpdate																		
attributes	<table border="1"> <thead> <tr> <th>Name</th> <th>Type</th> <th>Use</th> <th>Default</th> <th>Fixed</th> <th>annotation</th> </tr> </thead> <tbody> <tr> <td>MID</td> <td>MessageIdType</td> <td>required</td> <td></td> <td></td> <td></td> </tr> <tr> <td>RelatedMID</td> <td>MessageIdType</td> <td>optional</td> <td></td> <td></td> <td></td> </tr> </tbody> </table>	Name	Type	Use	Default	Fixed	annotation	MID	MessageIdType	required				RelatedMID	MessageIdType	optional			
Name	Type	Use	Default	Fixed	annotation														
MID	MessageIdType	required																	
RelatedMID	MessageIdType	optional																	
annotation	documentation																		
source	<pre> <xs:complexType name="PremisesSpecialArrangementsUpdateType"> <xs:annotation> <xs:documentation> </xs:documentation> </xs:annotation> <xs:complexContent> <xs:extension base="MessageBody"> <xs:sequence> <xs:element ref="D2001_SPID"/> <xs:element ref="D4006_EffectiveFrom"/> <xs:element ref="D2004_ExemptCustomerFlag" minOccurs="0"/> <xs:element ref="D2041_PcentExemption" minOccurs="0"/> </xs:sequence> </xs:extension> </xs:complexContent> </pre> </pre>																		

</xs:complexType>

complexType **RegistrationStartType**

diagram																			
namespace	urn:bridgeall-com:cmaservice:data:v3																		
type	extension of MessageBody																		
properties	base MessageBody																		
children	D2001_SPID D4002_RegistrationStartDate																		
used by	elements ResponseMessagesType/T008.0 TerminationNotification ResponseMessagesType/T008.1 RegistrationConfirmation																		
attributes	<table border="1"> <thead> <tr> <th>Name</th> <th>Type</th> <th>Use</th> <th>Default</th> <th>Fixed</th> <th>annotation</th> </tr> </thead> <tbody> <tr> <td>MID</td> <td>MessageIdType</td> <td>required</td> <td></td> <td></td> <td></td> </tr> <tr> <td>RelatedMID</td> <td>MessageIdType</td> <td>optional</td> <td></td> <td></td> <td></td> </tr> </tbody> </table>	Name	Type	Use	Default	Fixed	annotation	MID	MessageIdType	required				RelatedMID	MessageIdType	optional			
Name	Type	Use	Default	Fixed	annotation														
MID	MessageIdType	required																	
RelatedMID	MessageIdType	optional																	
source	<pre> <xs:complexType name="RegistrationStartType"> <xs:annotation> <xs:documentation/> </xs:annotation> <xs:complexContent> <xs:extension base="MessageBody"> <xs:sequence> <xs:element ref="D2001_SPID"/> <xs:element ref="D4002_RegistrationStartDate"/> </xs:sequence> </xs:extension> </xs:complexContent> </xs:complexType> </pre>																		

complexType ResponseMessagesType

<p>diagram</p> 	
<p>namespace</p>	<p>urn:bridgeall-com:cmaservice:data:v3</p>
<p>children</p>	<p>T002.0_NewSPIDNotification T002.1_NewSPIDNotification T004.1_NewMeterNotification T005.2_MeterReadNotification T005.3_MeterReadNotification T006.4_WaterSPIDNotification T006.5_SewerageSPIDNotification T007.2_ConnectionCompleteNotification</p>

	<p>T008.0 TerminationNotification T008.1 RegistrationConfirmation T008.2 NotifyRSD T009.0 Notification T009.1 Notification T009.4 Notification T011.0 CancelRegistrationNotification T011.1 CancelRegistrationNotification T012.2 ServiceElementUpdateNotification T012.4 SewerageServiceElementUpdateNotification T012.6 UpdateSAAReferenceNumberUPRNNotification T013.1 MeterUpdate T013.3 UpdateMeterLocationNotification T014.1 MeterUpdateNotification T015.1 DisconnectionNotification T016.1 UnmeasureableNotification T017.1 MeterSwapNotification T019.0 WaterSPIDData T020.0 SewerageSPIDData T021.1 DPIDNotification T022.1 TEUpdateNotification T023.1 MeterAssociationNotification T024.1 MeterDisAssociationNotification T026.1 DiscontinueDPIDNotification T027.1 DPIDUpdateNotification T028.0 Schedule3UpdateNotification T029.0 SpecialArrangementsUpdateNotification T029.4 PremisesSpecialArrangementsUpdateNotification T030.0 DPMeterReadNotification T030.1 DPMeterReadNotification T032.1 CustomerNameUpdated T032.2 CustomerNameUpdatedNotification T033.1 MeteredBuildingUpdate T034.1 VacSchemeGracePeriodNotification T034.2 VacSchemeGraceEndNotification T034.3 VacSchemeApplicationNotification T034.5 VacSchemeApplicationConfirmationOrCancellationNotification T035.0 TradeabilityNotification T035.1 TradeabilityNotification T036.1 MeterNetworkAssociationNotification</p>
used by	element ResponseMessages
source	<pre><xs:complexType name="ResponseMessagesType"> <xs:sequence> <xs:choice maxOccurs="unbounded"> <xs:element name="T002.0_NewSPIDNotification" type="NewLPSPIDNotificationType"/> <xs:element name="T002.1_NewSPIDNotification" type="NewSPIDNotificationType"/> <xs:element name="T004.1_NewMeterNotification" type="T004.1_NewMeterNotificationType"/> <xs:element name="T005.2_MeterReadNotification" type="MeterReadNotificationType"/> <xs:element name="T005.3_MeterReadNotification" type="MeterReadNotificationType"/> <xs:element name="T006.4_WaterSPIDNotification" type="T006.4_WaterSPIDNotificationType"/> <xs:element name="T006.5_SewerageSPIDNotification" type="T006.5_SewerageSPIDNotificationType"/> <xs:element name="T007.2_ConnectionCompleteNotification" type="ConnectionCompleteType"/> <xs:element name="T008.0_TerminationNotification" type="RegistrationStartType"/> <xs:element name="T008.1_RegistrationConfirmation" type="RegistrationStartType"/> <xs:element name="T008.2_NotifyRSD" type="NotifyRSDType"/> <xs:element name="T009.0_Notification" type="NotificationType"/> <xs:element name="T009.1_Notification" type="NotificationType"/> <xs:element name="T009.4_Notification" type="T009.4_NotificationType"/> <xs:element name="T011.0_CancelRegistrationNotification" type="CancelRegistrationNotificationType"/> <xs:element name="T011.1_CancelRegistrationNotification" type="CancelRegistrationNotificationOutType"/> <xs:element name="T012.2_ServiceElementUpdateNotification" type="ServiceElementUpdateNotificationType"/> <xs:element name="T012.4_SewerageServiceElementUpdateNotification" type="SewerageServiceElementUpdateNotificationType"/> <xs:element name="T012.6_UpdateSAAReferenceNumberUPRNNotification" type="UpdateSAAReferenceNumberUPRNNotificationType"/> <xs:element name="T013.1_MeterUpdate" type="MeterUpdateNotificationType"/> <xs:element name="T013.3_UpdateMeterLocationNotification" type="UpdateMeterLocationNotificationType"/> </xs:choice> </xs:sequence> </xs:complexType></pre>

```

<xs:element name="T014.1_MeterUpdateNotification"
type="ChargeableMeterUpdateType"/>
<xs:element name="T015.1_DisconnectionNotification"
type="DisconnectionType"/>
<xs:element name="T016.1_UnmeasureableNotification"
type="T016.0_UnmeasureableDeclarationType"/>
<xs:element name="T017.1_MeterSwapNotification"
type="MeterSwapNotificationType"/>
<xs:element name="T019.0_WaterSPIDData" type="WaterSPIDData"/>
<xs:element name="T020.0_SewerageSPIDData"
type="SewerageSPIDData"/>
<xs:element name="T021.1_DPIDNotification" type="DPIDNotificationType"/>
<xs:element name="T022.1_TEUpdateNotification" type="TEUpdateType"/>
<xs:element name="T023.1_MeterAssociationNotification"
type="MeterAssociationType"/>
<xs:element name="T024.1_MeterDisAssociationNotification"
type="MeterDisAssociationType"/>
<xs:element name="T026.1_DiscontinueDPIDNotification"
type="DiscontinueDPIDType"/>
<xs:element name="T027.1_DPIDUpdateNotification"
type="DPIDUpdateType"/>
<xs:element name="T028.0_Schedule3UpdateNotification"
type="Schedule3UpdateType"/>
<xs:element name="T029.0_SpecialArrangementsUpdateNotification"
type="SpecialArrangementsUpdateNotificationType"/>
<xs:element
name="T029.4_PremisesSpecialArrangementsUpdateNotification"
type="PremisesSpecialArrangementsUpdateNotificationType"/>
<xs:element name="T030.0_DPMeterReadNotification"
type="DPMeterReadType"/>
<xs:element name="T030.1_DPMeterReadNotification"
type="DPMeterReadType"/>
<xs:element name="T032.1_CustomerNameUpdated"
type="T032.1_CustomerNameUpdatedType"/>
<xs:element name="T032.2_CustomerNameUpdatedNotification"
type="CustomerNameUpdatedNotificationType"/>
<xs:element name="T033.1_MeteredBuildingUpdate"
type="T033.1_MeteredBuildingUpdate"/>
<xs:element name="T034.1_VacSchemeGracePeriodNotification"
type="T034.1_VacSchemeGracePeriodNotification"/>
<xs:element name="T034.2_VacSchemeGraceEndNotification"
type="T034.2_VacSchemeGraceEndNotification"/>
<xs:element name="T034.3_VacSchemeApplicationNotification"
type="T034.3_VacSchemeApplicationNotification"/>
<xs:element
name="T034.5_VacSchemeApplicationConfirmationOrCancellationNotification"
type="T034.5_VacSchemeApplicationConfirmationOrCancellationNotification"/>
<xs:element name="T035.0_TradeabilityNotification"
type="T035.0_TradeabilityNotification"/>
<xs:element name="T035.1_TradeabilityNotification"
type="T035.1_TradeabilityNotification"/>
<xs:element name="T036.1_MeterNetworkAssociationNotification"
type="MeterNetworkAssociationType"/>
</xs:choice>
</xs:sequence>
</xs:complexType>

```

element **ResponseMessagesType/T002.0_NewSPIDNotification**

<p>diagram</p>																			
<p>namespace</p>	<p>urn:bridgeall-com:cmaservice:data:v3</p>																		
<p>type</p>	<p>NewLPSPIDNotificationType</p>																		
<p>properties</p>	<p>isRef 0 content complex</p>																		
<p>children</p>	<p>D2001_SPID Address UARNDData UPRNDData D2009_SWConnectionRef D2023_NewConnectionType D2034_AllocationMethod</p>																		
<p>attributes</p>	<table border="1"> <thead> <tr> <th>Name</th> <th>Type</th> <th>Use</th> <th>Default</th> <th>Fixed</th> <th>annotation</th> </tr> </thead> <tbody> <tr> <td>MID</td> <td>MessageIdType</td> <td>required</td> <td></td> <td></td> <td></td> </tr> <tr> <td>RelatedMID</td> <td>MessageIdType</td> <td>optional</td> <td></td> <td></td> <td></td> </tr> </tbody> </table>	Name	Type	Use	Default	Fixed	annotation	MID	MessageIdType	required				RelatedMID	MessageIdType	optional			
Name	Type	Use	Default	Fixed	annotation														
MID	MessageIdType	required																	
RelatedMID	MessageIdType	optional																	
<p>source</p>	<pre><xs:element name="T002.0_NewSPIDNotification" type="NewLPSPIDNotificationType"/></pre>																		

element **ResponseMessagesType/T002.1_NewSPIDNotification**

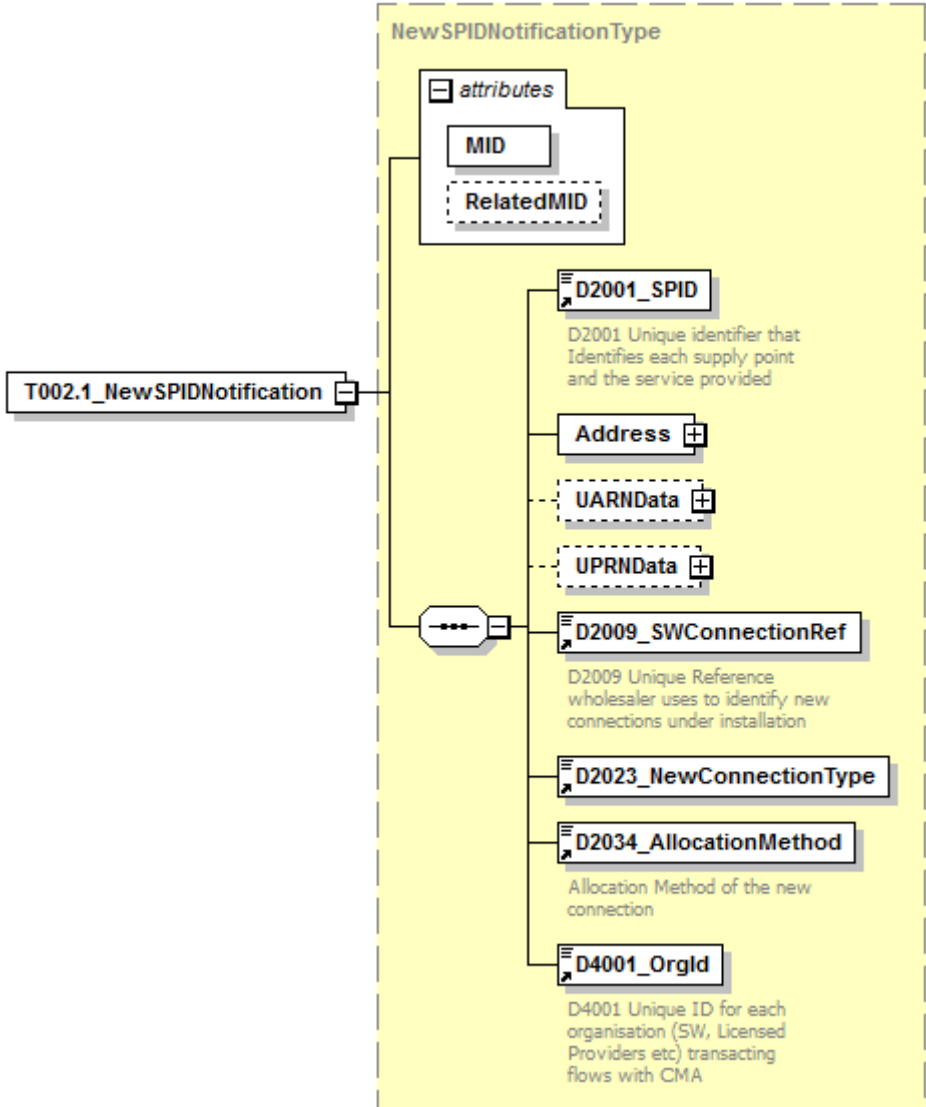
<p>diagram</p>																			
<p>namespace</p>	<p>urn:bridgeall-com:cmaservice:data:v3</p>																		
<p>type</p>	<p>NewSPIDNotificationType</p>																		
<p>properties</p>	<p>isRef 0 content complex</p>																		
<p>children</p>	<p>D2001_SPID Address UARNDData UPRNDData D2009_SWConnectionRef D2023_NewConnectionType D2034_AllocationMethod D4001_OrgId</p>																		
<p>attributes</p>	<table border="1"> <thead> <tr> <th>Name</th> <th>Type</th> <th>Use</th> <th>Default</th> <th>Fixed</th> <th>annotation</th> </tr> </thead> <tbody> <tr> <td>MID</td> <td>MessageIdType</td> <td>required</td> <td></td> <td></td> <td></td> </tr> <tr> <td>RelatedMID</td> <td>MessageIdType</td> <td>optional</td> <td></td> <td></td> <td></td> </tr> </tbody> </table>	Name	Type	Use	Default	Fixed	annotation	MID	MessageIdType	required				RelatedMID	MessageIdType	optional			
Name	Type	Use	Default	Fixed	annotation														
MID	MessageIdType	required																	
RelatedMID	MessageIdType	optional																	
<p>source</p>	<pre><xs:element name="T002.1_NewSPIDNotification" type="NewSPIDNotificationType"/></pre>																		

element **ResponseMessagesType/T004.1_NewMeterNotification**

<p>diagram</p>	<p>The diagram illustrates the structure of the T004.1_NewMeterNotificationType element. It is a complex type containing several attributes and elements. The structure is as follows:</p> <ul style="list-style-type: none"> attributes (group): <ul style="list-style-type: none"> MID (string) RelatedMID (string) D2001_SPID (string): D2001 Unique identifier that Identifies each supply point and the service provided D3001_MeterId (string): Meter Identification (e.g. manufacturers serial number) D3004_NrDigits (integer): The number of digits on the meter register MeterLocation (string) D3003_PhysicalMeterSize (integer): Actual size of a meter (mm) D3002_ChargeableMeterSize (integer): Meter size for tariff charge calculation purposes (mm) D3005_SewerageChargeableMet... (integer): The chargeable size for the Related Water Supply Meter for calculations of Sewerage tariff D3011_MeterReadFrequency (integer): The frequency that the LP must read a meter D3007_ReturnToSewerAllowance (integer): Return to sewer allowance for a particular meter D3013_MeterMake (string): Meter Make D3014_ManufacturerMeterSerial... (string): Meter Serial Number D2010_YVe (integer): Yearly Volumetric Usage Estimate for the SPID D3015_datalogger_SW (boolean): Specifies the presence of a Scottish Water datalogger D3016_datalogger_NonSW (boolean): Specifies the presence of a non Scottish Water datalogger D3017_GISX (integer): Specifies the X coordinate of the location of the meter D3018_GISY (integer): Specifies the Y coordinate of the location of the meter D3019_GISZFreeDescriptor (integer): Specifies the Z Free Descriptor of the location of the meter D3022_MeterTreatment (string): Meter Treatment Indicator D3025_MeterLocationCode (string): Meter Location Code
<p>namespace</p>	<p>urn:bridgeall-com:cmaservice:data:v3</p>
<p>type</p>	<p>T004.1_NewMeterNotificationType</p>

properties	isRef 0 content complex																		
children	D2001_SPID D3001_MeterId D3004_NrDigits MeterLocation D3003_PhysicalMeterSize D3002_ChargeableMeterSize D3005_SewerageChargeableMeterSize D3011_MeterReadFrequency D3007_ReturnToSewerAllowance D3013_MeterMake D3014_ManufacturerMeterSerialNr D2010_YVe D3015_datalogger_SW D3016_datalogger_NonSW D3017_GISX D3018_GISY D3019_GISZFreeDescriptor D3022_MeterTreatment D3025_MeterLocationCode																		
attributes	<table border="1"> <thead> <tr> <th>Name</th> <th>Type</th> <th>Use</th> <th>Default</th> <th>Fixed</th> <th>annotation</th> </tr> </thead> <tbody> <tr> <td>MID</td> <td>MessageIdType</td> <td>required</td> <td></td> <td></td> <td></td> </tr> <tr> <td>RelatedMID</td> <td>MessageIdType</td> <td>optional</td> <td></td> <td></td> <td></td> </tr> </tbody> </table>	Name	Type	Use	Default	Fixed	annotation	MID	MessageIdType	required				RelatedMID	MessageIdType	optional			
Name	Type	Use	Default	Fixed	annotation														
MID	MessageIdType	required																	
RelatedMID	MessageIdType	optional																	
source	<xs:element name="T004.1_NewMeterNotification" type="T004.1_NewMeterNotificationType"/>																		

element **ResponseMessagesType/T005.2_MeterReadNotification**

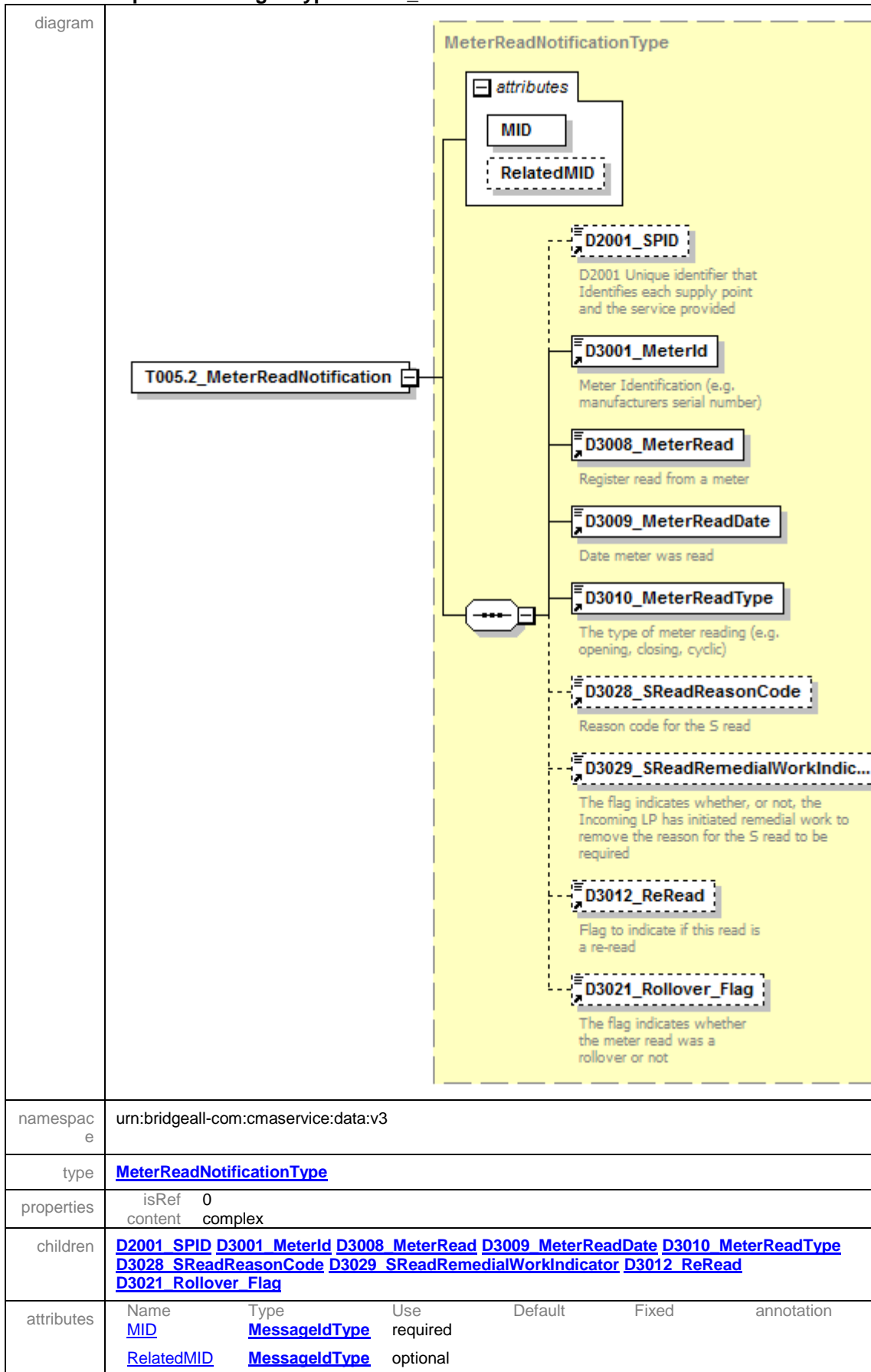

source	<code><xs:element name="T005.2_MeterReadNotification" type="MeterReadNotificationType"/></code>
--------	---

element **ResponseMessagesType/T005.3_MeterReadNotification**

diagram	<p>MeterReadNotificationType</p> <ul style="list-style-type: none"> attributes <ul style="list-style-type: none"> MID RelatedMID D2001_SPID: D2001 Unique identifier that Identifies each supply point and the service provided D3001_MeterId: Meter Identification (e.g. manufacturers serial number) D3008_MeterRead: Register read from a meter D3009_MeterReadDate: Date meter was read D3010_MeterReadType: The type of meter reading (e.g. opening, closing, cyclic) D3028_SReadReasonCode: Reason code for the S read D3029_SReadRemedialWorkIndic...: The flag indicates whether, or not, the Incoming LP has initiated remedial work to remove the reason for the S read to be required D3012_ReRead: Flag to indicate if this read is a re-read D3021_Rollover_Flag: The flag indicates whether the meter read was a rollover or not
namespace	urn:bridgeall-com:cmaservice:data:v3
type	MeterReadNotificationType
properties	isRef 0 content complex
children	D2001_SPID D3001_MeterId D3008_MeterRead D3009_MeterReadDate D3010_MeterReadType

	D3028_SReadReasonCode D3029_SReadRemedialWorkIndicator D3012_ReRead D3021_Rollover_Flag					
attributes	Name	Type	Use	Default	Fixed	annotation
	MID	MessageIdType	required			
	RelatedMID	MessageIdType	optional			
source	<code><xs:element name="T005.3_MeterReadNotification" type="MeterReadNotificationType"/></code>					

element **ResponseMessagesType/T006.4_WaterSPIDNotification**

diagram						
namespace	urn:bridgeall-com:cmaservice:data:v3					
type	T006.4_WaterSPIDNotificationType					
properties	isRef	0				
	content	complex				
children	D2001_SPID D2018_TroughsDrinkingBowls D2020_OutsideTaps D2011_RateableValue D2014_FarmCroft					
attributes	Name	Type	Use	Default	Fixed	annotation
	MID	MessageIdType	required			
	RelatedMID	MessageIdType	optional			
source	<code><xs:element name="T006.4_WaterSPIDNotification" type="T006.4_WaterSPIDNotificationType"/></code>					

element **ResponseMessageType/T006.5_SewerageSPIDNotification**

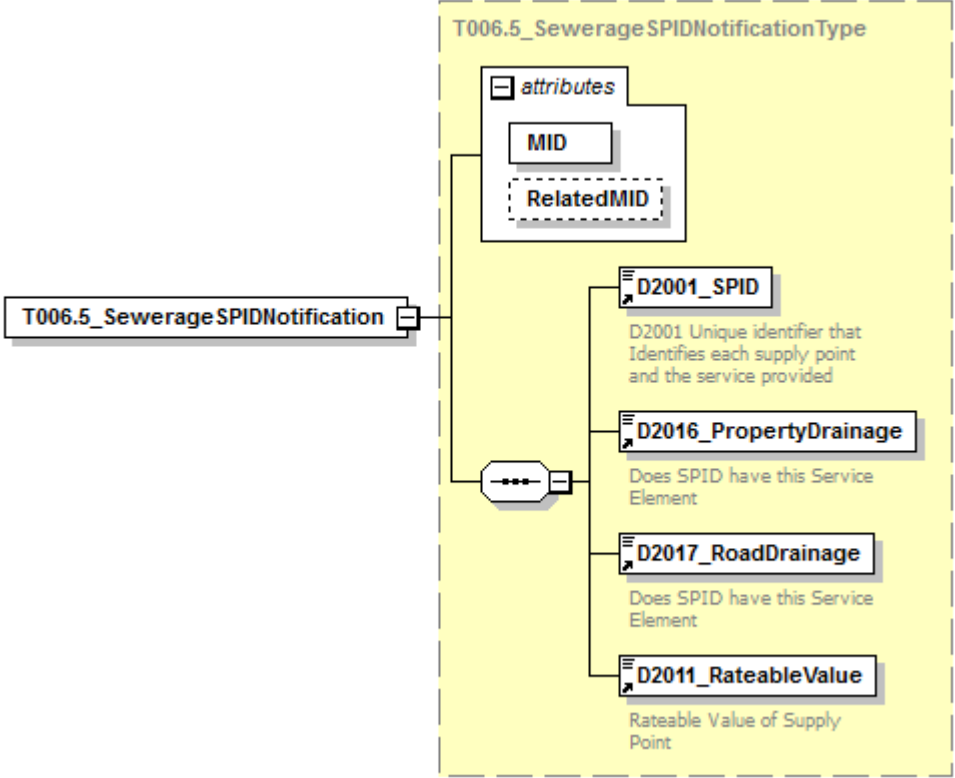
<p>diagram</p>																			
<p>namespace</p>	<p>urn:bridgeall-com:cmaservice:data:v3</p>																		
<p>type</p>	<p>T006.5_SewerageSPIDNotificationType</p>																		
<p>properties</p>	<p>isRef 0 content complex</p>																		
<p>children</p>	<p>D2001_SPID D2016_PropertyDrainage D2017_RoadDrainage D2011_RateableValue</p>																		
<p>attributes</p>	<table border="1"> <thead> <tr> <th>Name</th> <th>Type</th> <th>Use</th> <th>Default</th> <th>Fixed</th> <th>annotation</th> </tr> </thead> <tbody> <tr> <td>MID</td> <td>MessageIdType</td> <td>required</td> <td></td> <td></td> <td></td> </tr> <tr> <td>RelatedMID</td> <td>MessageIdType</td> <td>optional</td> <td></td> <td></td> <td></td> </tr> </tbody> </table>	Name	Type	Use	Default	Fixed	annotation	MID	MessageIdType	required				RelatedMID	MessageIdType	optional			
Name	Type	Use	Default	Fixed	annotation														
MID	MessageIdType	required																	
RelatedMID	MessageIdType	optional																	
<p>source</p>	<pre><xs:element name="T006.5_SewerageSPIDNotification" type="T006.5_SewerageSPIDNotificationType"/></pre>																		

element **ResponseMessagesType/T007.2_ConnectionCompleteNotification**

diagram						
namespace	urn:bridgeall-com:cmaservice:data:v3					
type	ConnectionCompleteType					
properties	isRef	0	content	complex		
children	D2001_SPID D2013_ConnectionDate					
attributes	Name	Type	Use	Default	Fixed	annotation
	MID	MessageIdType	required			
	RelatedMID	MessageIdType	optional			
source	<pre><xs:element name="T007.2_ConnectionCompleteNotification" type="ConnectionCompleteType"/></pre>					

element **ResponseMessagesType/T008.0_TerminationNotification**

diagram						
namespace	urn:bridgeall-com:cmaservice:data:v3					
type	RegistrationStartType					
properties	isRef	0	content	complex		

children	D2001_SPID D4002_RegistrationStartDate					
attributes	Name	Type	Use	Default	Fixed	annotation
	MID	MessageIdType	required			
	RelatedMID	MessageIdType	optional			
source	<code><xs:element name="T008.0_TerminationNotification" type="RegistrationStartType"/></code>					

element **ResponseMessagesType/T008.1_RegistrationConfirmation**

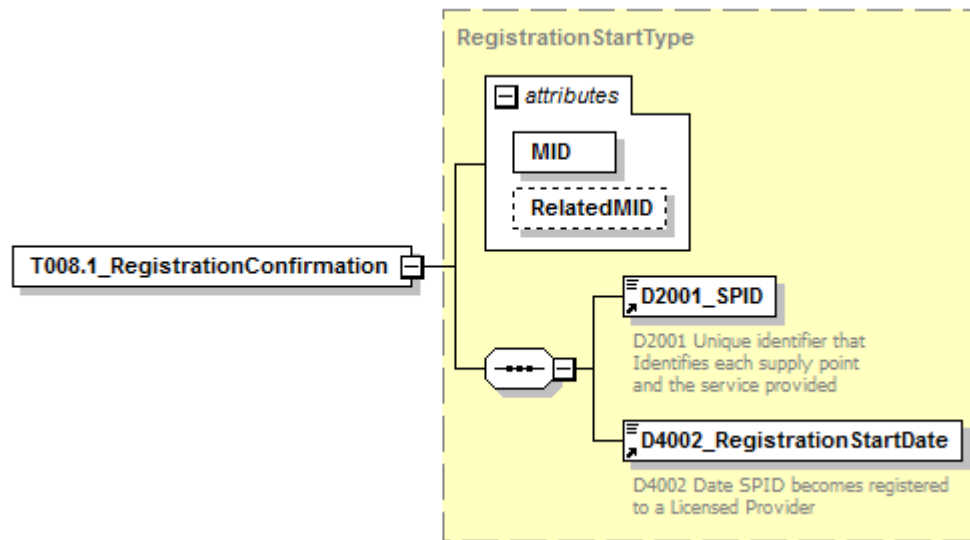
diagram						
namespace	urn:bridgeall-com:cmaservice:data:v3					
type	RegistrationStartType					
properties	isRef	0				
	content	complex				
children	D2001_SPID D4002_RegistrationStartDate					
attributes	Name	Type	Use	Default	Fixed	annotation
	MID	MessageIdType	required			
	RelatedMID	MessageIdType	optional			
source	<code><xs:element name="T008.1_RegistrationConfirmation" type="RegistrationStartType"/></code>					

element **ResponseMessagesType/T008.2_NotifyRSD**

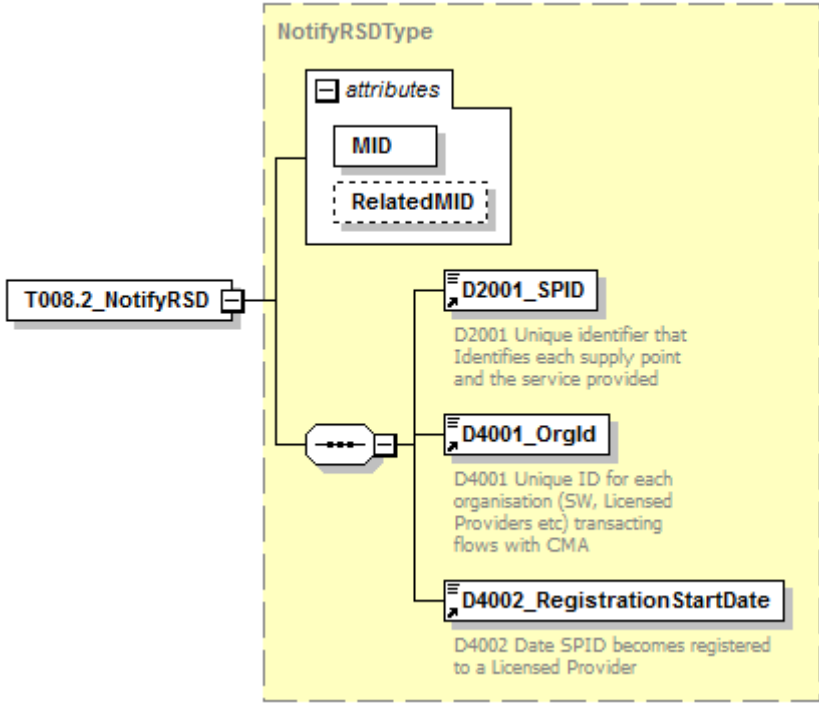
diagram																			
namespace	urn:bridgeall-com:cmaservice:data:v3																		
type	NotifyRSDType																		
properties	isRef 0 content complex																		
children	D2001_SPID D4001_OrgId D4002_RegistrationStartDate																		
attributes	<table border="1"> <thead> <tr> <th>Name</th> <th>Type</th> <th>Use</th> <th>Default</th> <th>Fixed</th> <th>annotation</th> </tr> </thead> <tbody> <tr> <td>MID</td> <td>MessageIdType</td> <td>required</td> <td></td> <td></td> <td></td> </tr> <tr> <td>RelatedMID</td> <td>MessageIdType</td> <td>optional</td> <td></td> <td></td> <td></td> </tr> </tbody> </table>	Name	Type	Use	Default	Fixed	annotation	MID	MessageIdType	required				RelatedMID	MessageIdType	optional			
Name	Type	Use	Default	Fixed	annotation														
MID	MessageIdType	required																	
RelatedMID	MessageIdType	optional																	
source	<xs:element name="T008.2_NotifyRSD" type="NotifyRSDType"/>																		

element **ResponseMessagesType/T009.0_Notification**

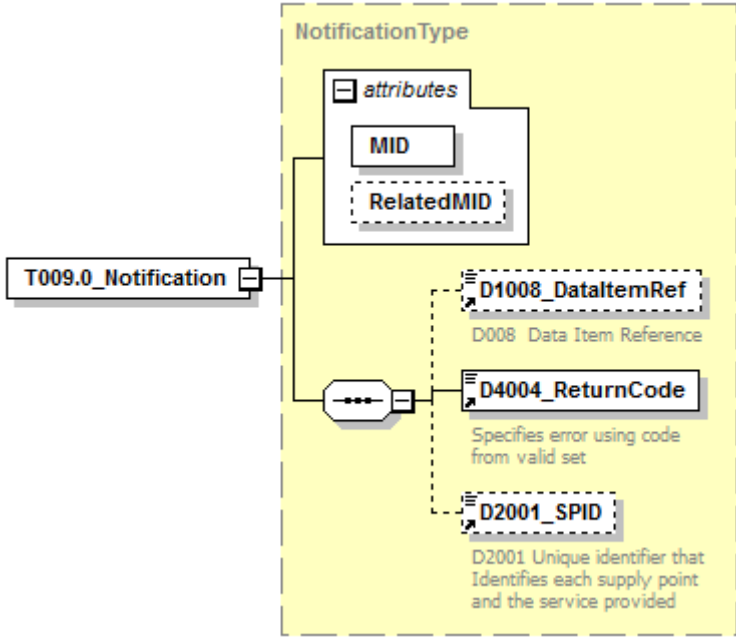
diagram						
namespace	urn:bridgeall-com:cmaservice:data:v3					
type	NotificationType					
properties	isRef	0				
	content	complex				
children	D1008_DataItemRef D4004_ReturnCode D2001_SPID					
attributes	Name	Type	Use	Default	Fixed	annotation
	MID	MessageIdType	required			
	RelatedMID	MessageIdType	optional			
source	<code><xs:element name="T009.0_Notification" type="NotificationType"/></code>					

element **ResponseMessagesType/T009.1_Notification**

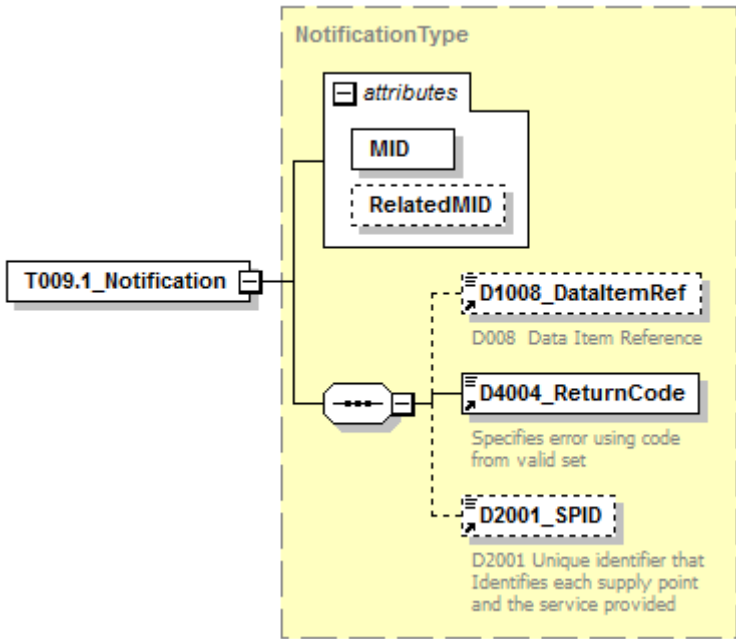
diagram						
---------	--	--	--	--	--	--

namespace	urn:bridgeall-com:cmaservice:data:v3					
type	NotificationType					
properties	isRef	0				
	content	complex				
children	D1008 DataItemRef D4004 ReturnCode D2001 SPID					
attributes	Name	Type	Use	Default	Fixed	annotation
	MID	MessageIDType	required			
	RelatedMID	MessageIDType	optional			
source	<xs:element name="T009.1_Notification" type="NotificationType"/>					

element **ResponseMessagesType/T009.4_Notification**

diagram						
namespace	urn:bridgeall-com:cmaservice:data:v3					
type	T009.4_NotificationType					
properties	isRef	0				
	content	complex				
children	D1009 DuplicateMessageID D4004 ReturnCode					
attributes	Name	Type	Use	Default	Fixed	annotation
	MID	MessageIDType	required			
	RelatedMID	MessageIDType	optional			
source	<xs:element name="T009.4_Notification" type="T009.4_NotificationType"/>					

element **ResponseMessageType/T011.0_CancelRegistrationNotification**

diagram						
namespace	urn:bridgeall-com:cmaservice:data:v3					
type	CancelRegistrationNotificationType					
properties	isRef	0				
	content	complex				
children	D2001_SPID D4003_Comment D4005_CancellationCode					
attributes	Name	Type	Use	Default	Fixed	annotation
	MID	MessageIdType	required			
	RelatedMID	MessageIdType	optional			
source	<code><xs:element name="T011.0_CancelRegistrationNotification" type="CancelRegistrationNotificationType"/></code>					

element **ResponseMessageType/T011.1_CancelRegistrationNotification**

diagram						
namespace	urn:bridgeall-com:cmaservice:data:v3					
type	CancelRegistrationNotificationOutType					

properties	isRef 0 content complex																		
children	D2001_SPID																		
attributes	<table border="1"> <thead> <tr> <th>Name</th> <th>Type</th> <th>Use</th> <th>Default</th> <th>Fixed</th> <th>annotation</th> </tr> </thead> <tbody> <tr> <td>MID</td> <td>MessageIdType</td> <td>required</td> <td></td> <td></td> <td></td> </tr> <tr> <td>RelatedMID</td> <td>MessageIdType</td> <td>optional</td> <td></td> <td></td> <td></td> </tr> </tbody> </table>	Name	Type	Use	Default	Fixed	annotation	MID	MessageIdType	required				RelatedMID	MessageIdType	optional			
Name	Type	Use	Default	Fixed	annotation														
MID	MessageIdType	required																	
RelatedMID	MessageIdType	optional																	
source	<code><xs:element name="T011.1_CancelRegistrationNotification" type="CancelRegistrationNotificationOutType"/></code>																		

element **ResponseMessages/T012.2_ServiceElementUpdateNotification**

diagram																			
namespace	urn:bridgeall-com:cmaservice:data:v3																		
type	ServiceElementUpdateNotificationType																		
properties	isRef 0 content complex																		
children	D2001_SPID D2015_SPIDVacant D4006_EffectiveFrom D4003_Comment																		
attributes	<table border="1"> <thead> <tr> <th>Name</th> <th>Type</th> <th>Use</th> <th>Default</th> <th>Fixed</th> <th>annotation</th> </tr> </thead> <tbody> <tr> <td>MID</td> <td>MessageIdType</td> <td>required</td> <td></td> <td></td> <td></td> </tr> <tr> <td>RelatedMID</td> <td>MessageIdType</td> <td>optional</td> <td></td> <td></td> <td></td> </tr> </tbody> </table>	Name	Type	Use	Default	Fixed	annotation	MID	MessageIdType	required				RelatedMID	MessageIdType	optional			
Name	Type	Use	Default	Fixed	annotation														
MID	MessageIdType	required																	
RelatedMID	MessageIdType	optional																	
source	<code><xs:element name="T012.2_ServiceElementUpdateNotification" type="ServiceElementUpdateNotificationType"/></code>																		

element **ResponseMessagesType/T012.4_SewerageServiceElementUpdateNotification**

<p>diagram</p>																			
<p>namespace</p>	<p>urn:bridgeall-com:cmaservice:data:v3</p>																		
<p>type</p>	<p>SewerageServiceElementUpdateNotificationType</p>																		
<p>properties</p>	<p>isRef 0 content complex</p>																		
<p>children</p>	<p>D2001_SPID D4006_EffectiveFrom D2016_PropertyDrainage D2017_RoadDrainage D4003_Comment</p>																		
<p>attributes</p>	<table border="1"> <thead> <tr> <th>Name</th> <th>Type</th> <th>Use</th> <th>Default</th> <th>Fixed</th> <th>annotation</th> </tr> </thead> <tbody> <tr> <td>MID</td> <td>MessageIdType</td> <td>required</td> <td></td> <td></td> <td></td> </tr> <tr> <td>RelatedMID</td> <td>MessageIdType</td> <td>optional</td> <td></td> <td></td> <td></td> </tr> </tbody> </table>	Name	Type	Use	Default	Fixed	annotation	MID	MessageIdType	required				RelatedMID	MessageIdType	optional			
Name	Type	Use	Default	Fixed	annotation														
MID	MessageIdType	required																	
RelatedMID	MessageIdType	optional																	
<p>source</p>	<pre><xs:element name="T012.4_SewerageServiceElementUpdateNotification" type="SewerageServiceElementUpdateNotificationType"/></pre>																		

element

ResponseMessageType/T012.6_UpdateSAARefereceNumberUPRNNotification

<p>diagram</p>																			
<p>namespa ce</p>	<p>urn:bridgeall-com:cmaservice:data:v3</p>																		
<p>type</p>	<p>UpdateSAARefereceNumberUPRNNotificationType</p>																		
<p>properties</p>	<p>isRef 0 content complex</p>																		
<p>children</p>	<p>D2001_SPID UARNDData UPRNData</p>																		
<p>attributes</p>	<table border="1"> <thead> <tr> <th>Name</th> <th>Type</th> <th>Use</th> <th>Default</th> <th>Fixed</th> <th>annotation</th> </tr> </thead> <tbody> <tr> <td>MID</td> <td>MessageIdType</td> <td>required</td> <td></td> <td></td> <td></td> </tr> <tr> <td>RelatedMID</td> <td>MessageIdType</td> <td>optional</td> <td></td> <td></td> <td></td> </tr> </tbody> </table>	Name	Type	Use	Default	Fixed	annotation	MID	MessageIdType	required				RelatedMID	MessageIdType	optional			
Name	Type	Use	Default	Fixed	annotation														
MID	MessageIdType	required																	
RelatedMID	MessageIdType	optional																	
<p>source</p>	<pre><xs:element name="T012.6_UpdateSAARefereceNumberUPRNNotification" type="UpdateSAARefereceNumberUPRNNotificationType"/></pre>																		

element **ResponseMessagesType/T013.1_MeterUpdate**

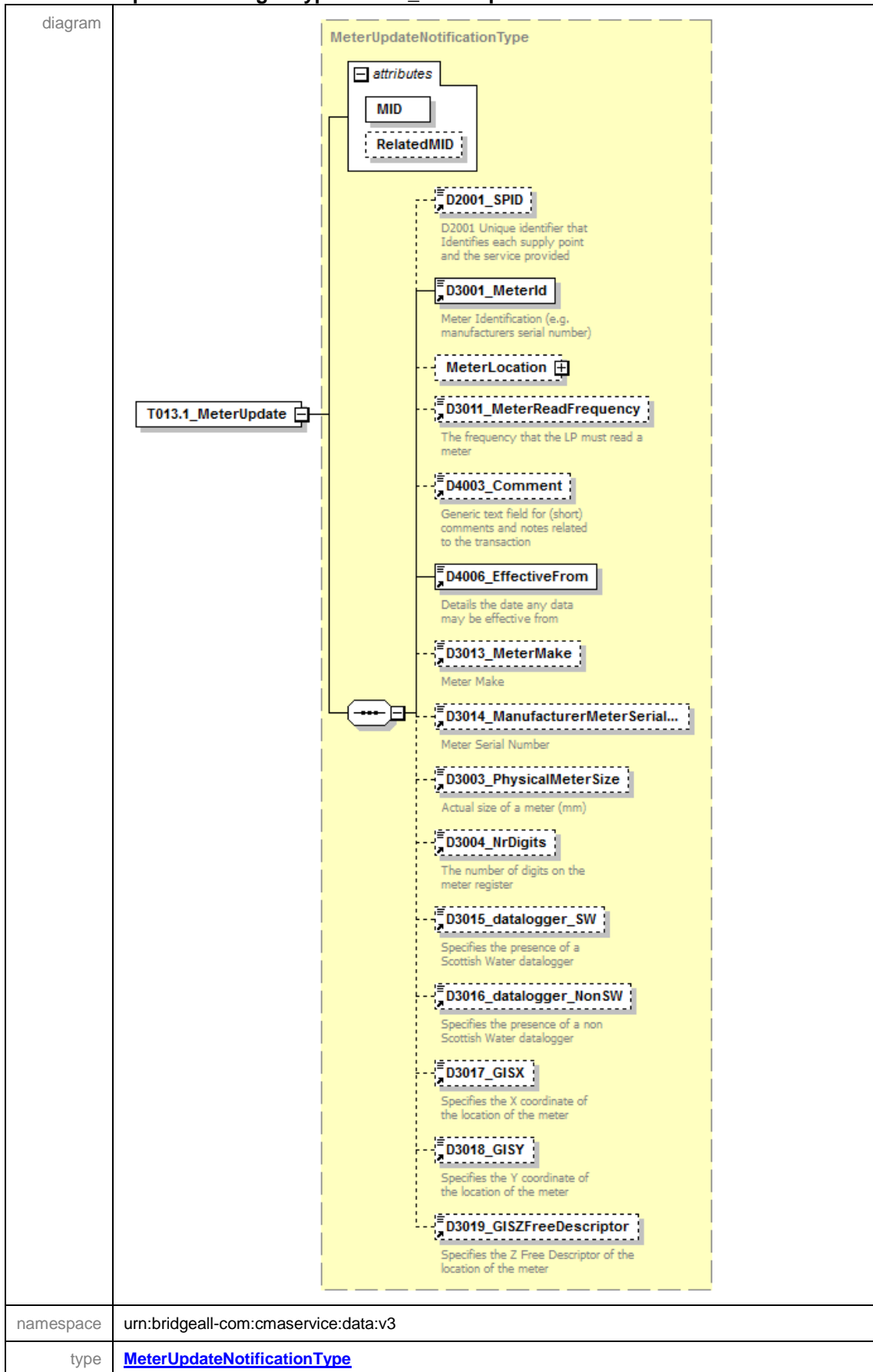

properties	isRef 0 content complex																		
children	D2001_SPID D3001_MeterId MeterLocation D3011_MeterReadFrequency D4003_Comment D4006_EffectiveFrom D3013_MeterMake D3014_ManufacturerMeterSerialNr D3003_PhysicalMeterSize D3004_NrDigits D3015_datalogger_SW D3016_datalogger_NonSW D3017_GISX D3018_GISY D3019_GISZFreeDescriptor																		
attributes	<table border="1"> <thead> <tr> <th>Name</th> <th>Type</th> <th>Use</th> <th>Default</th> <th>Fixed</th> <th>annotation</th> </tr> </thead> <tbody> <tr> <td>MID</td> <td>MessageIdType</td> <td>required</td> <td></td> <td></td> <td></td> </tr> <tr> <td>RelatedMID</td> <td>MessageIdType</td> <td>optional</td> <td></td> <td></td> <td></td> </tr> </tbody> </table>	Name	Type	Use	Default	Fixed	annotation	MID	MessageIdType	required				RelatedMID	MessageIdType	optional			
Name	Type	Use	Default	Fixed	annotation														
MID	MessageIdType	required																	
RelatedMID	MessageIdType	optional																	
source	<code><xs:element name="T013.1_MeterUpdate" type="MeterUpdateNotificationType"/></code>																		

element ResponseMessagesType/T013.3_UpdateMeterLocationNotification

diagram																			
namespace	urn:bridgeall-com:cmaservice:data:v3																		
type	UpdateMeterLocationNotificationType																		
properties	isRef 0 content complex																		
children	D2001_SPID D3001_MeterId D3019_GISZFreeDescriptor D3025_MeterLocationCode																		
attributes	<table border="1"> <thead> <tr> <th>Name</th> <th>Type</th> <th>Use</th> <th>Default</th> <th>Fixed</th> <th>annotation</th> </tr> </thead> <tbody> <tr> <td>MID</td> <td>MessageIdType</td> <td>required</td> <td></td> <td></td> <td></td> </tr> <tr> <td>RelatedMID</td> <td>MessageIdType</td> <td>optional</td> <td></td> <td></td> <td></td> </tr> </tbody> </table>	Name	Type	Use	Default	Fixed	annotation	MID	MessageIdType	required				RelatedMID	MessageIdType	optional			
Name	Type	Use	Default	Fixed	annotation														
MID	MessageIdType	required																	
RelatedMID	MessageIdType	optional																	
source	<code><xs:element name="T013.3_UpdateMeterLocationNotification" type="UpdateMeterLocationNotificationType"/></code>																		

element **ResponseMessageType/T014.1_MeterUpdateNotification**

<p>diagram</p>																			
<p>namespace</p>	<p>urn:bridgeall-com:cmaservice:data:v3</p>																		
<p>type</p>	<p>ChargeableMeterUpdateType</p>																		
<p>properties</p>	<p>isRef 0 content complex</p>																		
<p>children</p>	<p>D2001_SPID D3001_MeterId D3002_ChargeableMeterSize D3005_SewerageChargeableMeterSize D4003_Comment D3007_ReturnToSewerAllowance D4006_EffectiveFrom</p>																		
<p>attributes</p>	<table border="1"> <thead> <tr> <th>Name</th> <th>Type</th> <th>Use</th> <th>Default</th> <th>Fixed</th> <th>annotation</th> </tr> </thead> <tbody> <tr> <td>MID</td> <td>MessageIdType</td> <td>required</td> <td></td> <td></td> <td></td> </tr> <tr> <td>RelatedMID</td> <td>MessageIdType</td> <td>optional</td> <td></td> <td></td> <td></td> </tr> </tbody> </table>	Name	Type	Use	Default	Fixed	annotation	MID	MessageIdType	required				RelatedMID	MessageIdType	optional			
Name	Type	Use	Default	Fixed	annotation														
MID	MessageIdType	required																	
RelatedMID	MessageIdType	optional																	
<p>source</p>	<pre><xs:element name="T014.1_MeterUpdateNotification" type="ChargeableMeterUpdateType"/></pre>																		

element **ResponseMessagesType/T015.1_DisconnectionNotification**

diagram																			
namespace	urn:bridgeall-com:cmaservice:data:v3																		
type	DisconnectionType																		
properties	isRef 0 content complex																		
children	D2001_SPID D4006_EffectiveFrom D2025_DisconnectionReconnection																		
attributes	<table border="1"> <thead> <tr> <th>Name</th> <th>Type</th> <th>Use</th> <th>Default</th> <th>Fixed</th> <th>annotation</th> </tr> </thead> <tbody> <tr> <td>MID</td> <td>MessageIdType</td> <td>required</td> <td></td> <td></td> <td></td> </tr> <tr> <td>RelatedMID</td> <td>MessageIdType</td> <td>optional</td> <td></td> <td></td> <td></td> </tr> </tbody> </table>	Name	Type	Use	Default	Fixed	annotation	MID	MessageIdType	required				RelatedMID	MessageIdType	optional			
Name	Type	Use	Default	Fixed	annotation														
MID	MessageIdType	required																	
RelatedMID	MessageIdType	optional																	
source	<pre><xs:element name="T015.1_DisconnectionNotification" type="DisconnectionType"/></pre>																		

element **ResponseMessagesType/T016.1_UnmeasureableNotification**

<p>diagram</p>																			
<p>namespace</p>	<p>urn:bridgeall-com:cmaservice:data:v3</p>																		
<p>type</p>	<p>T016.0_UnmeasureableDeclarationType</p>																		
<p>properties</p>	<p>isRef 0 content complex</p>																		
<p>children</p>	<p>D2001_SPID D2024_Unmeasurable D4006_EffectiveFrom</p>																		
<p>attributes</p>	<table border="1"> <thead> <tr> <th>Name</th> <th>Type</th> <th>Use</th> <th>Default</th> <th>Fixed</th> <th>annotation</th> </tr> </thead> <tbody> <tr> <td>MID</td> <td>MessageIdType</td> <td>required</td> <td></td> <td></td> <td></td> </tr> <tr> <td>RelatedMID</td> <td>MessageIdType</td> <td>optional</td> <td></td> <td></td> <td></td> </tr> </tbody> </table>	Name	Type	Use	Default	Fixed	annotation	MID	MessageIdType	required				RelatedMID	MessageIdType	optional			
Name	Type	Use	Default	Fixed	annotation														
MID	MessageIdType	required																	
RelatedMID	MessageIdType	optional																	
<p>source</p>	<pre><xs:element name="T016.1_UnmeasureableNotification" type="T016.0_UnmeasureableDeclarationType"/></pre>																		

element **ResponseMessagesType/T017.1_MeterSwapNotification**

diagram	<p>The diagram illustrates the structure of the T017.1_MeterSwapNotification element. It is a complex type containing an attributes group and a complex content group. The attributes group includes MID (required) and RelatedMID (optional). The complex content group includes D2001_SPID (required), NewMeter (required), OldMeter (required), and D3012_ReRead (optional). The D2001_SPID element is described as a unique identifier for supply points and services. The D3012_ReRead element is a flag indicating if a read is a re-read.</p>																		
namespace	urn:bridgeall-com:cmaservice:data:v3																		
type	MeterSwapNotificationType																		
properties	isRef 0 content complex																		
children	D2001_SPID NewMeter OldMeter D3012_ReRead																		
attributes	<table border="1"> <thead> <tr> <th>Name</th> <th>Type</th> <th>Use</th> <th>Default</th> <th>Fixed</th> <th>annotation</th> </tr> </thead> <tbody> <tr> <td>MID</td> <td>MessageIdType</td> <td>required</td> <td></td> <td></td> <td></td> </tr> <tr> <td>RelatedMID</td> <td>MessageIdType</td> <td>optional</td> <td></td> <td></td> <td></td> </tr> </tbody> </table>	Name	Type	Use	Default	Fixed	annotation	MID	MessageIdType	required				RelatedMID	MessageIdType	optional			
Name	Type	Use	Default	Fixed	annotation														
MID	MessageIdType	required																	
RelatedMID	MessageIdType	optional																	
source	<pre><xs:element name="T017.1_MeterSwapNotification" type="MeterSwapNotificationType"/></pre>																		

element **ResponseMessagesType/T019.0_WaterSPIDData**

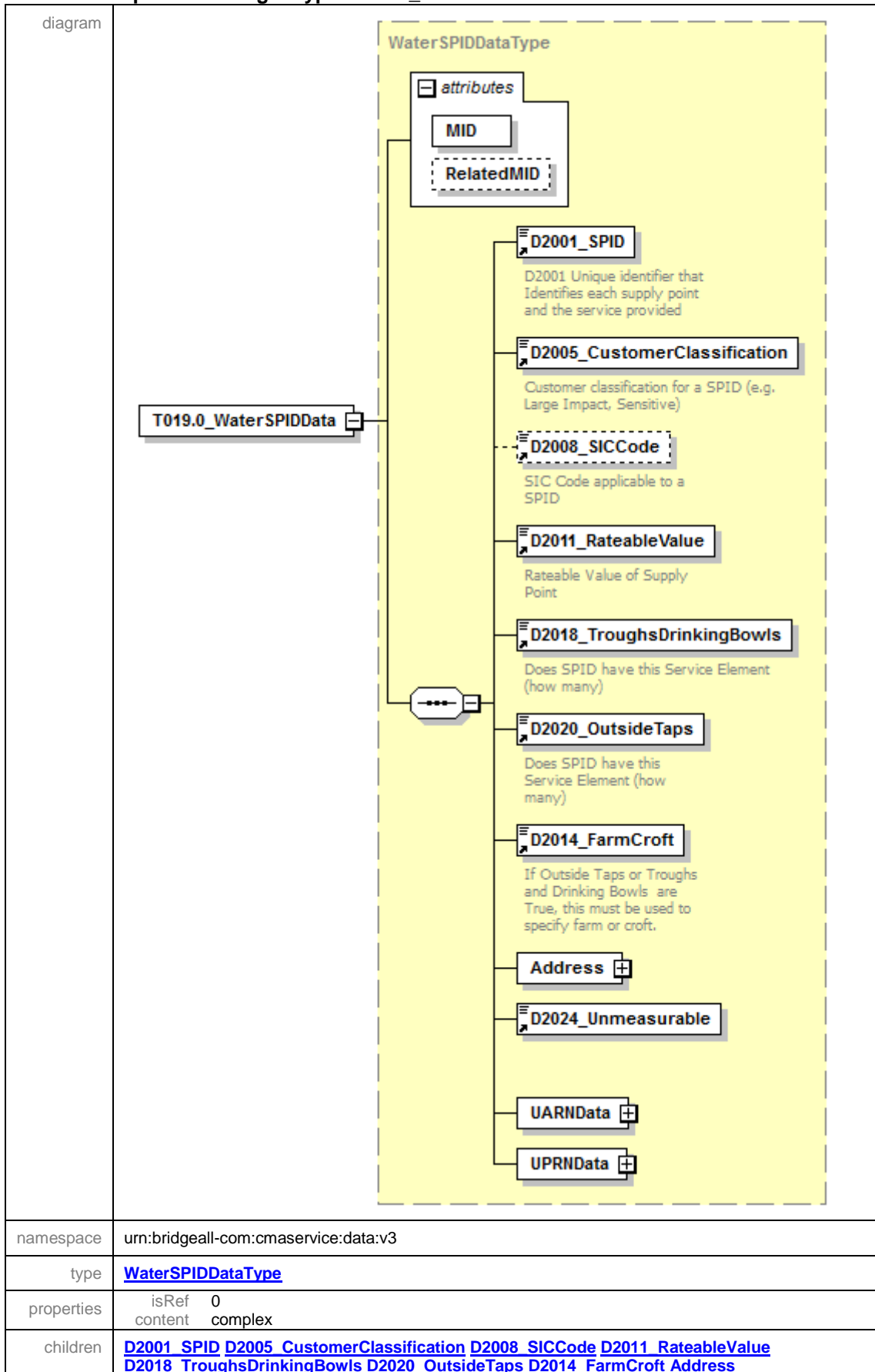

	D2024 Unmeasurable UARNDData UPRNDData					
attributes	Name	Type	Use	Default	Fixed	annotation
	MID	MessageIdType	required			
	RelatedMID	MessageIdType	optional			
source	<code><xs:element name="T019.0_WaterSPIDData" type="WaterSPIDDataType"/></code>					

element **ResponseMessagesType/T020.0_SewerageSPIDData**

diagram	<p>The diagram illustrates the structure of the T020.0_SewerageSPIDData element. It is a complex type containing the following components:</p> <ul style="list-style-type: none"> attributes (group): <ul style="list-style-type: none"> MID: Required attribute of type MessageIdType. RelatedMID: Optional attribute of type MessageIdType. D2001_SPID: Unique identifier for each supply point and the service provided. D2005_CustomerClassification: Customer classification for a SPID (e.g., Large Impact, Sensitive). D2008_SICCode: SIC Code applicable to a SPID. D2011_RateableValue: Rateable Value of Supply Point. D2012_SurfaceArea: Surface Area of SP for Settlement Calculations. D2016_PropertyDrainage: Does SPID have this Service Element. D2017_RoadDrainage: Does SPID have this Service Element. Address: Text element. UARNDData: Text element. UPRNDData: Text element.
namespace	urn:bridgeall-com:cmaservice:data:v3
type	SewerageSPIDDataType

properties	isRef 0 content complex																		
children	D2001_SPID D2005_CustomerClassification D2008_SICCode D2011_RateableValue D2012_SurfaceArea D2016_PropertyDrainage D2017_RoadDrainage Address UARNDData UPRNDData																		
attributes	<table border="1"> <thead> <tr> <th>Name</th> <th>Type</th> <th>Use</th> <th>Default</th> <th>Fixed</th> <th>annotation</th> </tr> </thead> <tbody> <tr> <td>MID</td> <td>MessageIdType</td> <td>required</td> <td></td> <td></td> <td></td> </tr> <tr> <td>RelatedMID</td> <td>MessageIdType</td> <td>optional</td> <td></td> <td></td> <td></td> </tr> </tbody> </table>	Name	Type	Use	Default	Fixed	annotation	MID	MessageIdType	required				RelatedMID	MessageIdType	optional			
Name	Type	Use	Default	Fixed	annotation														
MID	MessageIdType	required																	
RelatedMID	MessageIdType	optional																	
source	<code><xs:element name="T020.0_SewerageSPIDData" type="SewerageSPIDDataType"/></code>																		

element **ResponseMessagesType/T021.1_DPIDNotification**

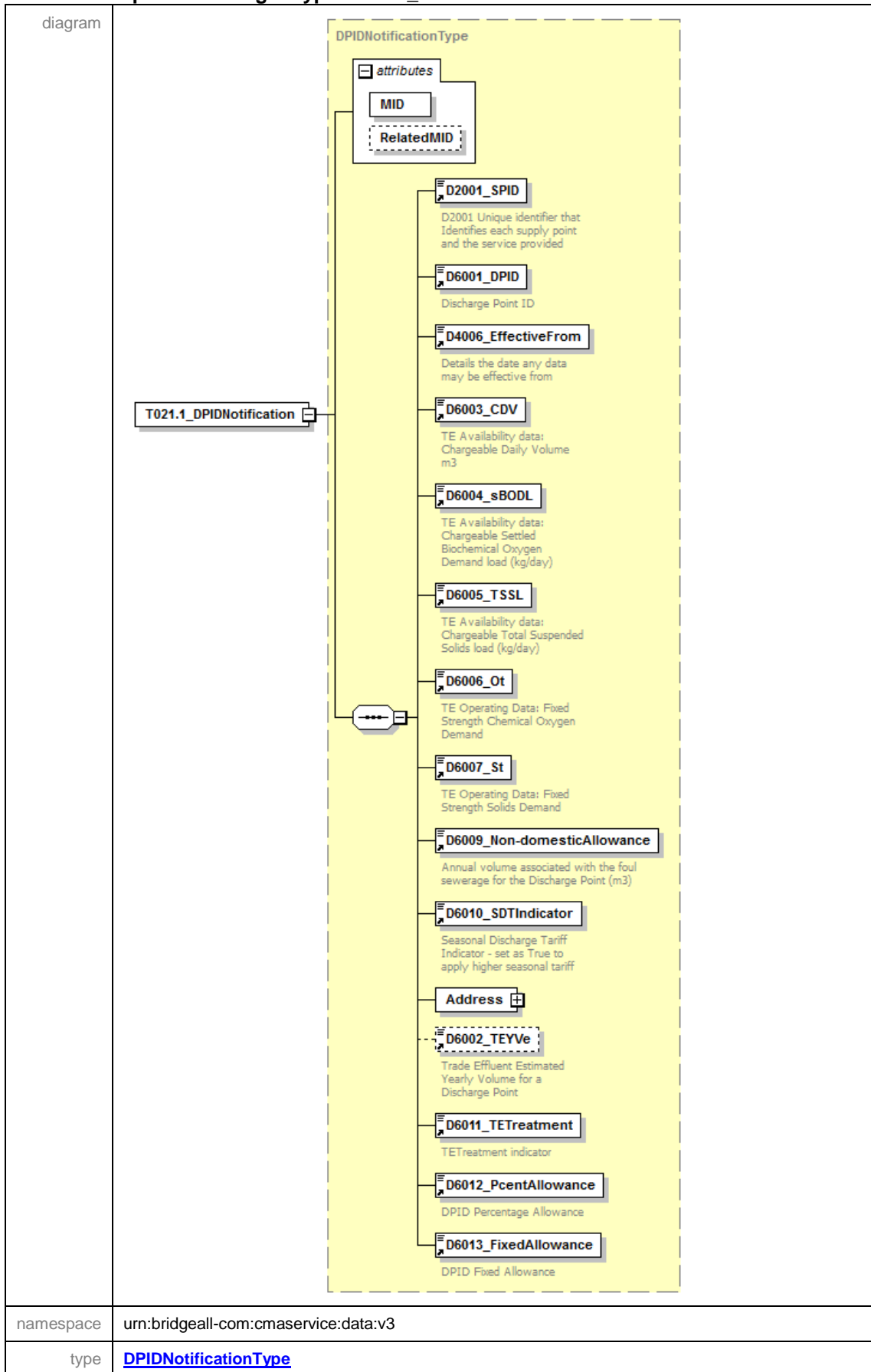

properties	isRef 0 content complex																		
children	D2001_SPID D6001_DPID D4006_EffectiveFrom D6003_CDV D6004_sBODL D6005_TSSL D6006_Ot D6007_St D6009_Non-domesticAllowance D6010_SDTIndicator Address D6002_TEYVe D6011_TETreatment D6012_PcentAllowance D6013_FixedAllowance																		
attributes	<table border="1"> <thead> <tr> <th>Name</th> <th>Type</th> <th>Use</th> <th>Default</th> <th>Fixed</th> <th>annotation</th> </tr> </thead> <tbody> <tr> <td>MID</td> <td>MessageIdType</td> <td>required</td> <td></td> <td></td> <td></td> </tr> <tr> <td>RelatedMID</td> <td>MessageIdType</td> <td>optional</td> <td></td> <td></td> <td></td> </tr> </tbody> </table>	Name	Type	Use	Default	Fixed	annotation	MID	MessageIdType	required				RelatedMID	MessageIdType	optional			
Name	Type	Use	Default	Fixed	annotation														
MID	MessageIdType	required																	
RelatedMID	MessageIdType	optional																	
source	<code><xs:element name="T021.1_DPIDNotification" type="DPIDNotificationType"/></code>																		

element ResponseMessagesType/T022.1_TEUpdateNotification

diagram																			
namespace	urn:bridgeall-com:cmaservice:data:v3																		
type	TEUpdateType																		
properties	isRef 0 content complex																		
children	D2001_SPID D6001_DPID D4006_EffectiveFrom D6006_Ot D6007_St																		
attributes	<table border="1"> <thead> <tr> <th>Name</th> <th>Type</th> <th>Use</th> <th>Default</th> <th>Fixed</th> <th>annotation</th> </tr> </thead> <tbody> <tr> <td>MID</td> <td>MessageIdType</td> <td>required</td> <td></td> <td></td> <td></td> </tr> <tr> <td>RelatedMID</td> <td>MessageIdType</td> <td>optional</td> <td></td> <td></td> <td></td> </tr> </tbody> </table>	Name	Type	Use	Default	Fixed	annotation	MID	MessageIdType	required				RelatedMID	MessageIdType	optional			
Name	Type	Use	Default	Fixed	annotation														
MID	MessageIdType	required																	
RelatedMID	MessageIdType	optional																	
source	<code><xs:element name="T022.1_TEUpdateNotification" type="TEUpdateType"/></code>																		

element **ResponseMessagesType/T023.1_MeterAssociationNotification**

<p>diagram</p>	<p>The diagram illustrates the structure of the T023.1_MeterAssociationNotification element. It is a complex type containing an attributes group and five data elements:</p> <ul style="list-style-type: none"> attributes (group): Contains MID (required) and RelatedMID (optional). D2001_SPID: D2001 Unique identifier that Identifies each supply point and the service provided. D6001_DPID: Discharge Point ID. D3001_MeterId: Meter Identification (e.g. manufacturers serial number). D4006_EffectiveFrom: Details the date any data may be effective from. D3024_MDVol: The Meter-DPID Volume for a particular DP-MeterAssociation. 																		
<p>namespace</p>	<p>urn:bridgeall-com:cmaservice:data:v3</p>																		
<p>type</p>	<p>MeterAssociationType</p>																		
<p>properties</p>	<p>isRef 0 content complex</p>																		
<p>children</p>	<p>D2001_SPID D6001_DPID D3001_MeterId D4006_EffectiveFrom D3024_MDVol</p>																		
<p>attributes</p>	<table border="1"> <thead> <tr> <th>Name</th> <th>Type</th> <th>Use</th> <th>Default</th> <th>Fixed</th> <th>annotation</th> </tr> </thead> <tbody> <tr> <td>MID</td> <td>MessageIdType</td> <td>required</td> <td></td> <td></td> <td></td> </tr> <tr> <td>RelatedMID</td> <td>MessageIdType</td> <td>optional</td> <td></td> <td></td> <td></td> </tr> </tbody> </table>	Name	Type	Use	Default	Fixed	annotation	MID	MessageIdType	required				RelatedMID	MessageIdType	optional			
Name	Type	Use	Default	Fixed	annotation														
MID	MessageIdType	required																	
RelatedMID	MessageIdType	optional																	
<p>source</p>	<pre><xs:element name="T023.1_MeterAssociationNotification" type="MeterAssociationType"/></pre>																		

element **ResponseMessagesType/T024.1_MeterDisAssociationNotification**

<p>diagram</p>																			
<p>namespace</p>	<p>urn:bridgeall-com:cmaservice:data:v3</p>																		
<p>type</p>	<p>MeterDisAssociationType</p>																		
<p>properties</p>	<p>isRef 0 content complex</p>																		
<p>children</p>	<p>D2001_SPID D6001_DPID D3001_MeterId D4006_EffectiveFrom</p>																		
<p>attributes</p>	<table border="1"> <thead> <tr> <th>Name</th> <th>Type</th> <th>Use</th> <th>Default</th> <th>Fixed</th> <th>annotation</th> </tr> </thead> <tbody> <tr> <td>MID</td> <td>MessageIdType</td> <td>required</td> <td></td> <td></td> <td></td> </tr> <tr> <td>RelatedMID</td> <td>MessageIdType</td> <td>optional</td> <td></td> <td></td> <td></td> </tr> </tbody> </table>	Name	Type	Use	Default	Fixed	annotation	MID	MessageIdType	required				RelatedMID	MessageIdType	optional			
Name	Type	Use	Default	Fixed	annotation														
MID	MessageIdType	required																	
RelatedMID	MessageIdType	optional																	
<p>source</p>	<pre><xs:element name="T024.1_MeterDisAssociationNotification" type="MeterDisAssociationType"/></pre>																		

element **ResponseMessagesType/T026.1_DiscontinueDPIDNotification**

<p>diagram</p>																			
<p>namespace</p>	<p>urn:bridgeall-com:cmaservice:data:v3</p>																		
<p>type</p>	<p>DiscontinueDPIDType</p>																		
<p>properties</p>	<p>isRef 0 content complex</p>																		
<p>children</p>	<p>D2001_SPID D6001_DPID D4006_EffectiveFrom</p>																		
<p>attributes</p>	<table border="1"> <thead> <tr> <th>Name</th> <th>Type</th> <th>Use</th> <th>Default</th> <th>Fixed</th> <th>annotation</th> </tr> </thead> <tbody> <tr> <td>MID</td> <td>MessageIDType</td> <td>required</td> <td></td> <td></td> <td></td> </tr> <tr> <td>RelatedMID</td> <td>MessageIDType</td> <td>optional</td> <td></td> <td></td> <td></td> </tr> </tbody> </table>	Name	Type	Use	Default	Fixed	annotation	MID	MessageIDType	required				RelatedMID	MessageIDType	optional			
Name	Type	Use	Default	Fixed	annotation														
MID	MessageIDType	required																	
RelatedMID	MessageIDType	optional																	
<p>source</p>	<pre><xs:element name="T026.1_DiscontinueDPIDNotification" type="DiscontinueDPIDType"/></pre>																		

element **ResponseMessagesType/T027.1_DPIDUpdateNotification**

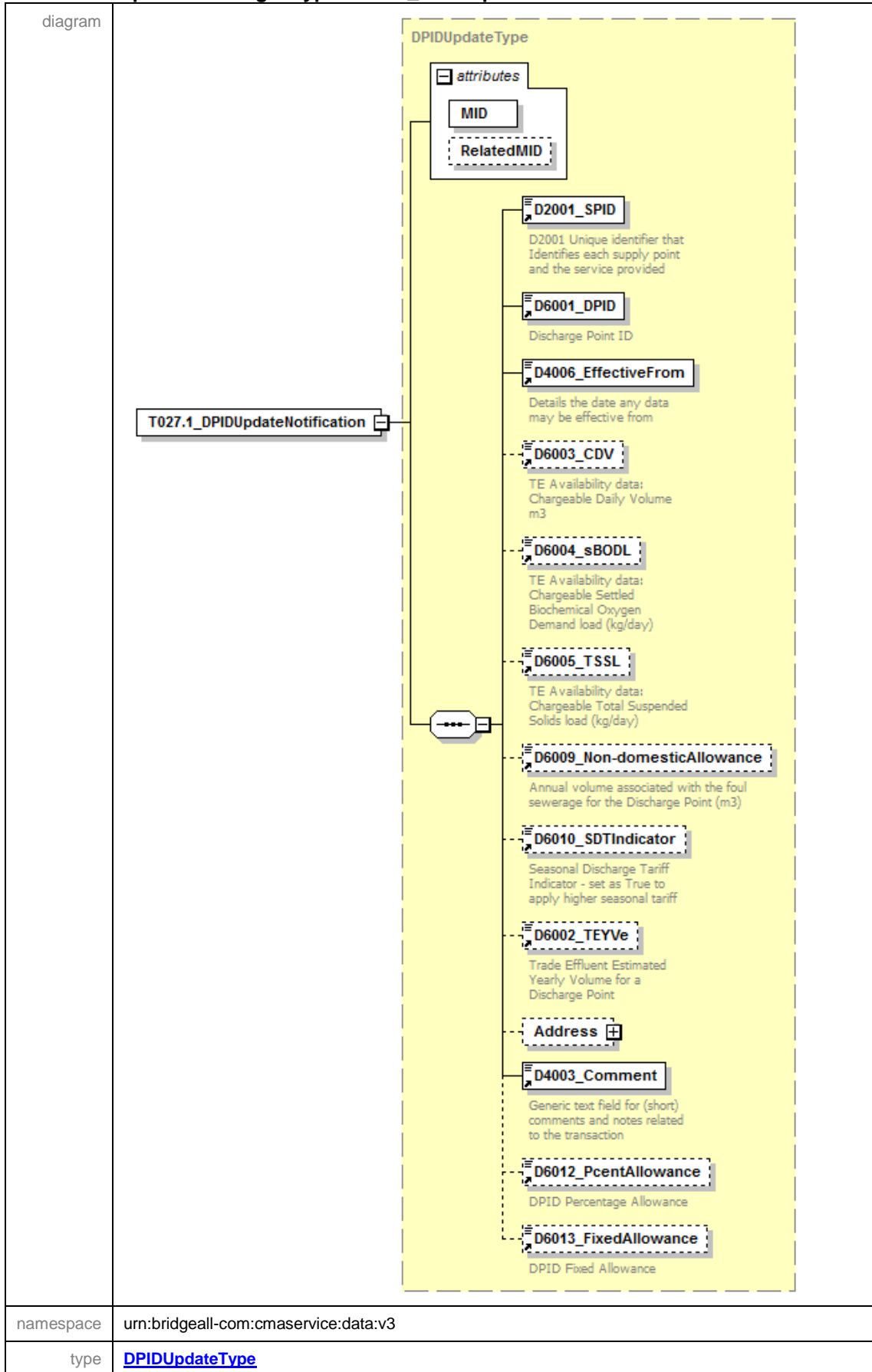

properties	isRef 0 content complex																		
children	D2001_SPID D6001_DPID D4006_EffectiveFrom D6003_CDV D6004_sBODL D6005_TSSL D6009_Non-domesticAllowance D6010_SDTIndicator D6002_TeyVe Address D4003_Comment D6012_PcentAllowance D6013_FixedAllowance																		
attributes	<table border="1"> <thead> <tr> <th>Name</th> <th>Type</th> <th>Use</th> <th>Default</th> <th>Fixed</th> <th>annotation</th> </tr> </thead> <tbody> <tr> <td>MID</td> <td>MessageIdType</td> <td>required</td> <td></td> <td></td> <td></td> </tr> <tr> <td>RelatedMID</td> <td>MessageIdType</td> <td>optional</td> <td></td> <td></td> <td></td> </tr> </tbody> </table>	Name	Type	Use	Default	Fixed	annotation	MID	MessageIdType	required				RelatedMID	MessageIdType	optional			
Name	Type	Use	Default	Fixed	annotation														
MID	MessageIdType	required																	
RelatedMID	MessageIdType	optional																	
source	<code><xs:element name="T027.1_DPIDUpdateNotification" type="DPIDUpdateType"/></code>																		

element **ResponseMessagesType/T028.0_Schedule3UpdateNotification**

diagram																			
namespace	urn:bridgeall-com:cmaservice:data:v3																		
type	Schedule3UpdateType																		
properties	isRef 0 content complex																		
children	D2001_SPID D2003_Schedule3 D4006_EffectiveFrom D6001_DPID																		
attributes	<table border="1"> <thead> <tr> <th>Name</th> <th>Type</th> <th>Use</th> <th>Default</th> <th>Fixed</th> <th>annotation</th> </tr> </thead> <tbody> <tr> <td>MID</td> <td>MessageIdType</td> <td>required</td> <td></td> <td></td> <td></td> </tr> <tr> <td>RelatedMID</td> <td>MessageIdType</td> <td>optional</td> <td></td> <td></td> <td></td> </tr> </tbody> </table>	Name	Type	Use	Default	Fixed	annotation	MID	MessageIdType	required				RelatedMID	MessageIdType	optional			
Name	Type	Use	Default	Fixed	annotation														
MID	MessageIdType	required																	
RelatedMID	MessageIdType	optional																	
source	<code><xs:element name="T028.0_Schedule3UpdateNotification" type="Schedule3UpdateType"/></code>																		

element **ResponseMessagesType/T029.0_SpecialArrangementsUpdateNotification**

<p>diagram</p>	<div style="border: 1px dashed black; padding: 5px;"> <p>SpecialArrangementsUpdateNotificationType</p> <ul style="list-style-type: none"> attributes <ul style="list-style-type: none"> MID RelatedMID D2001_SPID D2001 Unique identifier that Identifies each supply point and the service provided D4006_EffectiveFrom Details the date any data may be effective from D2003_Schedule3 Schedule 3 percentage discount applied to service element D2004_ExemptCustomerFlag Scottish Executive Exempt Scheme flag D2041_PcentExemption The percentage of the D2004_ExemptCustomerFlag that is applied D2006_29e 29e percentage discount applied per SPID D2007_LargeVolAgreement Large-User Volume Agreement (LUV A) for SPID </div>																		
<p>namespace</p>	<p>urn:bridgeall-com:cmaservice:data:v3</p>																		
<p>type</p>	<p>SpecialArrangementsUpdateNotificationType</p>																		
<p>properties</p>	<p>isRef 0 content complex</p>																		
<p>children</p>	<p>D2001_SPID D4006_EffectiveFrom D2003_Schedule3 D2004_ExemptCustomerFlag D2041_PcentExemption D2006_29e D2007_LargeVolAgreement</p>																		
<p>attributes</p>	<table border="1"> <thead> <tr> <th>Name</th> <th>Type</th> <th>Use</th> <th>Default</th> <th>Fixed</th> <th>annotation</th> </tr> </thead> <tbody> <tr> <td>MID</td> <td>MessageIdType</td> <td>required</td> <td></td> <td></td> <td></td> </tr> <tr> <td>RelatedMID</td> <td>MessageIdType</td> <td>optional</td> <td></td> <td></td> <td></td> </tr> </tbody> </table>	Name	Type	Use	Default	Fixed	annotation	MID	MessageIdType	required				RelatedMID	MessageIdType	optional			
Name	Type	Use	Default	Fixed	annotation														
MID	MessageIdType	required																	
RelatedMID	MessageIdType	optional																	
<p>source</p>	<pre><xs:element name="T029.0_SpecialArrangementsUpdateNotification" type="SpecialArrangementsUpdateNotificationType"/></pre>																		

element

ResponseMessageType/T029.4_PremisesSpecialArrangementsUpdateNotification

<p>diagram</p>																			
<p>namespace</p>	<p>urn:bridgeall-com:cmaservice:data:v3</p>																		
<p>type</p>	<p>PremisesSpecialArrangementsUpdateNotificationType</p>																		
<p>properties</p>	<p>isRef 0 content complex</p>																		
<p>children</p>	<p>D2001_SPID D4006_EffectiveFrom D2004_ExemptCustomerFlag D2041_PcentExemption</p>																		
<p>attributes</p>	<table border="1"> <thead> <tr> <th>Name</th> <th>Type</th> <th>Use</th> <th>Default</th> <th>Fixed</th> <th>annotation</th> </tr> </thead> <tbody> <tr> <td>MID</td> <td>MessageIdType</td> <td>required</td> <td></td> <td></td> <td></td> </tr> <tr> <td>RelatedMID</td> <td>MessageIdType</td> <td>optional</td> <td></td> <td></td> <td></td> </tr> </tbody> </table>	Name	Type	Use	Default	Fixed	annotation	MID	MessageIdType	required				RelatedMID	MessageIdType	optional			
Name	Type	Use	Default	Fixed	annotation														
MID	MessageIdType	required																	
RelatedMID	MessageIdType	optional																	
<p>source</p>	<pre><xs:element name="T029.4_PremisesSpecialArrangementsUpdateNotification" type="PremisesSpecialArrangementsUpdateNotificationType"/></pre>																		

element **ResponseMessagesType/T030.0_DPMeterReadNotification**

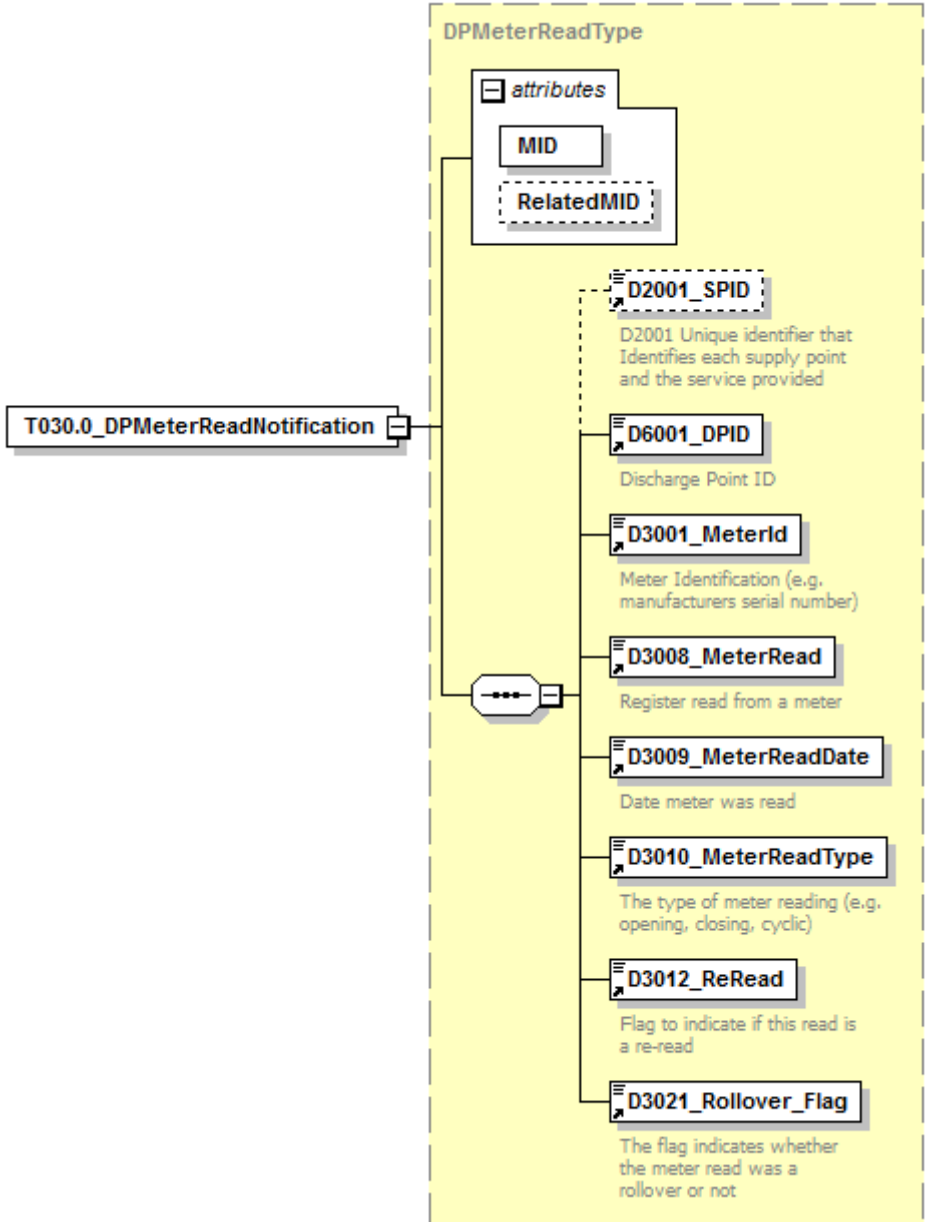
<p>diagram</p>																			
<p>namespace</p>	<p>urn:bridgeall-com:cmaservice:data:v3</p>																		
<p>type</p>	<p>DPMeterReadType</p>																		
<p>properties</p>	<p>isRef 0 content complex</p>																		
<p>children</p>	<p>D2001_SPID D6001_DPID D3001_MeterId D3008_MeterRead D3009_MeterReadDate D3010_MeterReadType D3012_ReRead D3021_Rollover_Flag</p>																		
<p>attributes</p>	<table border="1"> <thead> <tr> <th>Name</th> <th>Type</th> <th>Use</th> <th>Default</th> <th>Fixed</th> <th>annotation</th> </tr> </thead> <tbody> <tr> <td>MID</td> <td>MessageIdType</td> <td>required</td> <td></td> <td></td> <td></td> </tr> <tr> <td>RelatedMID</td> <td>MessageIdType</td> <td>optional</td> <td></td> <td></td> <td></td> </tr> </tbody> </table>	Name	Type	Use	Default	Fixed	annotation	MID	MessageIdType	required				RelatedMID	MessageIdType	optional			
Name	Type	Use	Default	Fixed	annotation														
MID	MessageIdType	required																	
RelatedMID	MessageIdType	optional																	
<p>source</p>	<pre><xs:element name="T030.0_DPMeterReadNotification" type="DPMeterReadType"/></pre>																		

element **ResponseMessagesType/T030.1_DPMeterReadNotification**

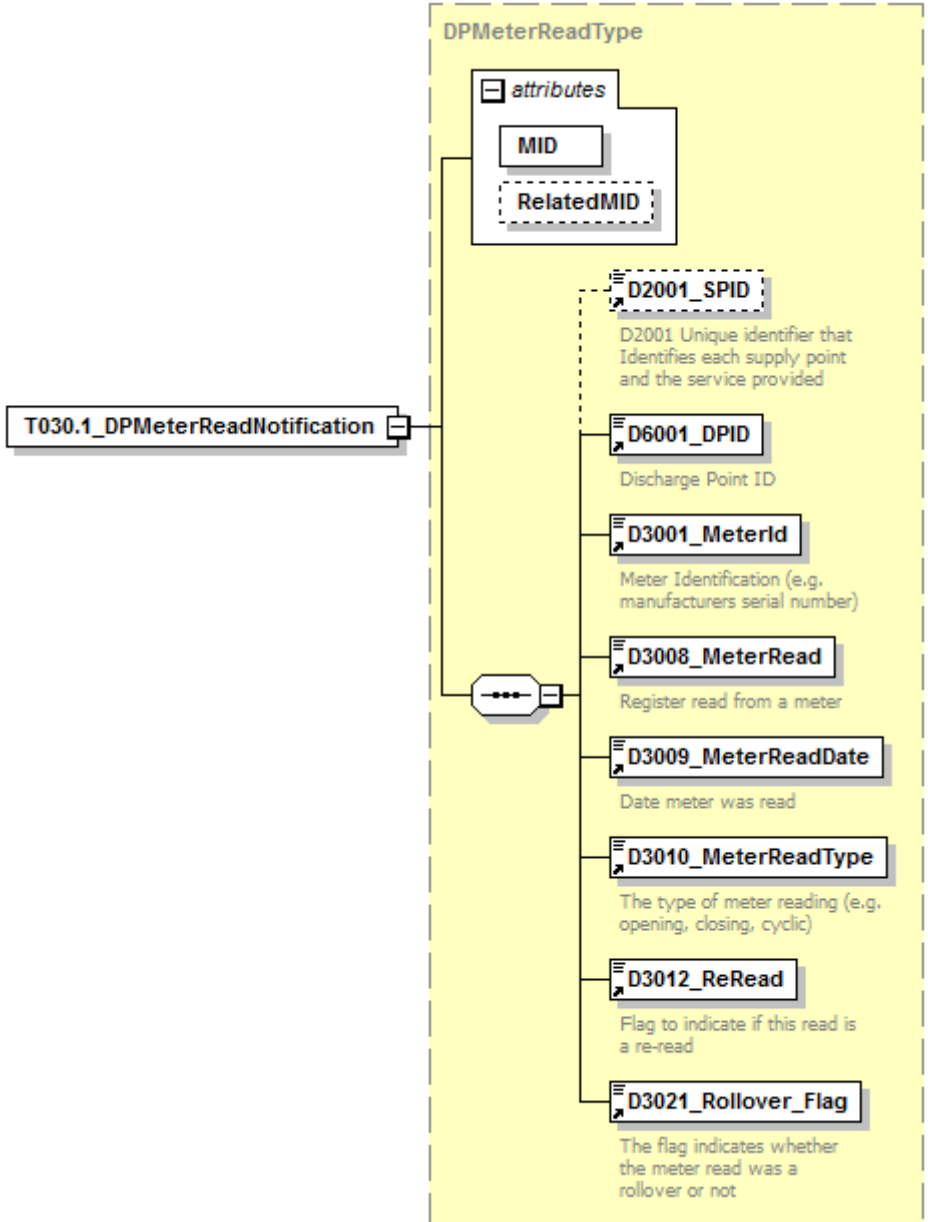
<p>diagram</p>																			
<p>namespace</p>	<p>urn:bridgeall-com:cmaservice:data:v3</p>																		
<p>type</p>	<p>DPMeterReadType</p>																		
<p>properties</p>	<p>isRef 0 content complex</p>																		
<p>children</p>	<p>D2001_SPID D6001_DPID D3001_MeterId D3008_MeterRead D3009_MeterReadDate D3010_MeterReadType D3012_ReRead D3021_Rollover_Flag</p>																		
<p>attributes</p>	<table border="1"> <thead> <tr> <th>Name</th> <th>Type</th> <th>Use</th> <th>Default</th> <th>Fixed</th> <th>annotation</th> </tr> </thead> <tbody> <tr> <td>MID</td> <td>MessageIdType</td> <td>required</td> <td></td> <td></td> <td></td> </tr> <tr> <td>RelatedMID</td> <td>MessageIdType</td> <td>optional</td> <td></td> <td></td> <td></td> </tr> </tbody> </table>	Name	Type	Use	Default	Fixed	annotation	MID	MessageIdType	required				RelatedMID	MessageIdType	optional			
Name	Type	Use	Default	Fixed	annotation														
MID	MessageIdType	required																	
RelatedMID	MessageIdType	optional																	
<p>source</p>	<pre><xs:element name="T030.1_DPMeterReadNotification" type="DPMeterReadType"/></pre>																		

element **ResponseMessagesType/T032.1_CustomerNameUpdated**

<p>diagram</p>																			
<p>namespace</p>	<p>urn:bridgeall-com:cmaservice:data:v3</p>																		
<p>type</p>	<p>T032.1_CustomerNameUpdatedType</p>																		
<p>properties</p>	<p>isRef 0 content complex</p>																		
<p>children</p>	<p>D2001_SPID D2027_CustomerName D2028_CustomerNameType</p>																		
<p>attributes</p>	<table border="1"> <thead> <tr> <th>Name</th> <th>Type</th> <th>Use</th> <th>Default</th> <th>Fixed</th> <th>annotation</th> </tr> </thead> <tbody> <tr> <td>MID</td> <td>MessageIdType</td> <td>required</td> <td></td> <td></td> <td></td> </tr> <tr> <td>RelatedMID</td> <td>MessageIdType</td> <td>optional</td> <td></td> <td></td> <td></td> </tr> </tbody> </table>	Name	Type	Use	Default	Fixed	annotation	MID	MessageIdType	required				RelatedMID	MessageIdType	optional			
Name	Type	Use	Default	Fixed	annotation														
MID	MessageIdType	required																	
RelatedMID	MessageIdType	optional																	
<p>source</p>	<pre><xs:element name="T032.1_CustomerNameUpdated" type="T032.1_CustomerNameUpdatedType"/></pre>																		

element **ResponseMessagesType/T032.2_CustomerNameUpdatedNotification**

<p>diagram</p>																			
<p>namespace</p>	<p>urn:bridgeall-com:cmaservice:data:v3</p>																		
<p>type</p>	<p>CustomerNameUpdatedNotificationType</p>																		
<p>properties</p>	<p>isRef 0 content complex</p>																		
<p>children</p>	<p>D2001_SPID D2027_CustomerName D2028_CustomerNameType D4001_OrgId</p>																		
<p>attributes</p>	<table border="1"> <thead> <tr> <th>Name</th> <th>Type</th> <th>Use</th> <th>Default</th> <th>Fixed</th> <th>annotation</th> </tr> </thead> <tbody> <tr> <td>MID</td> <td>MessageIdType</td> <td>required</td> <td></td> <td></td> <td></td> </tr> <tr> <td>RelatedMID</td> <td>MessageIdType</td> <td>optional</td> <td></td> <td></td> <td></td> </tr> </tbody> </table>	Name	Type	Use	Default	Fixed	annotation	MID	MessageIdType	required				RelatedMID	MessageIdType	optional			
Name	Type	Use	Default	Fixed	annotation														
MID	MessageIdType	required																	
RelatedMID	MessageIdType	optional																	
<p>source</p>	<pre><xs:element name="T032.2_CustomerNameUpdatedNotification" type="CustomerNameUpdatedNotificationType"/></pre>																		

element **ResponseMessageType/T033.1_MeteredBuildingUpdate**

<p>diagram</p>																			
<p>namespace</p>	<p>urn:bridgeall-com:cmaservice:data:v3</p>																		
<p>type</p>	<p>T033.1_MeteredBuildingUpdate</p>																		
<p>properties</p>	<p>isRef 0 content complex</p>																		
<p>children</p>	<p>D2001_SPID D2029_MeteredBuildingWater D2030_MeteredBuildingWaterEffectiveDate</p>																		
<p>attributes</p>	<table border="1"> <thead> <tr> <th>Name</th> <th>Type</th> <th>Use</th> <th>Default</th> <th>Fixed</th> <th>annotation</th> </tr> </thead> <tbody> <tr> <td>MID</td> <td>MessageIdType</td> <td>required</td> <td></td> <td></td> <td></td> </tr> <tr> <td>RelatedMID</td> <td>MessageIdType</td> <td>optional</td> <td></td> <td></td> <td></td> </tr> </tbody> </table>	Name	Type	Use	Default	Fixed	annotation	MID	MessageIdType	required				RelatedMID	MessageIdType	optional			
Name	Type	Use	Default	Fixed	annotation														
MID	MessageIdType	required																	
RelatedMID	MessageIdType	optional																	
<p>source</p>	<pre><xs:element name="T033.1_MeteredBuildingUpdate" type="T033.1_MeteredBuildingUpdate"/></pre>																		

element **ResponseMessagesType/T034.1_VacSchemeGracePeriodNotification**

<p>diagram</p>																			
<p>namespace</p>	<p>urn:bridgeall-com:cmaservice:data:v3</p>																		
<p>type</p>	<p>T034.1_VacSchemeGracePeriodNotification</p>																		
<p>properties</p>	<p>isRef 0 content complex</p>																		
<p>children</p>	<p>D2001_SPID D4006_EffectiveFrom D4007_DateOfEvidence D4003_Comment D4010_VacancyChangeGracePeriod</p>																		
<p>attributes</p>	<table border="1"> <thead> <tr> <th>Name</th> <th>Type</th> <th>Use</th> <th>Default</th> <th>Fixed</th> <th>annotation</th> </tr> </thead> <tbody> <tr> <td>MID</td> <td>MessageIdType</td> <td>required</td> <td></td> <td></td> <td></td> </tr> <tr> <td>RelatedMID</td> <td>MessageIdType</td> <td>optional</td> <td></td> <td></td> <td></td> </tr> </tbody> </table>	Name	Type	Use	Default	Fixed	annotation	MID	MessageIdType	required				RelatedMID	MessageIdType	optional			
Name	Type	Use	Default	Fixed	annotation														
MID	MessageIdType	required																	
RelatedMID	MessageIdType	optional																	
<p>source</p>	<pre><xs:element name="T034.1_VacSchemeGracePeriodNotification" type="T034.1_VacSchemeGracePeriodNotification"/></pre>																		

element **ResponseMessagesType/T034.2_VacSchemeGraceEndNotification**

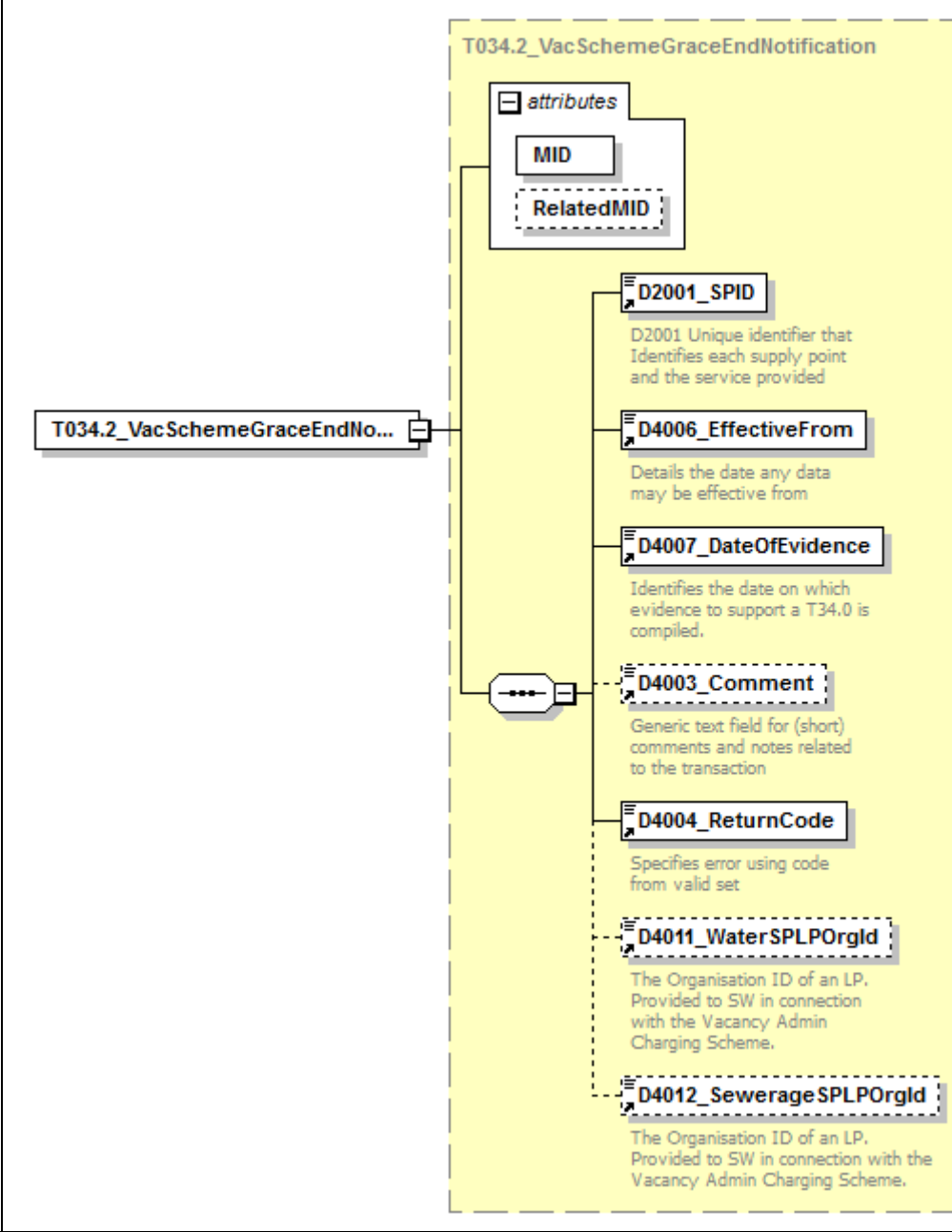
<p>diagram</p> 	<p>T034.2_VacSchemeGraceEndNotification</p> <ul style="list-style-type: none"> attributes <ul style="list-style-type: none"> MID RelatedMID D2001_SPID D2001 Unique identifier that Identifies each supply point and the service provided D4006_EffectiveFrom Details the date any data may be effective from D4007_DateOfEvidence Identifies the date on which evidence to support a T34.0 is compiled. D4003_Comment Generic text field for (short) comments and notes related to the transaction D4004_ReturnCode Specifies error using code from valid set D4011_WaterSPLPOrgId The Organisation ID of an LP. Provided to SW in connection with the Vacancy Admin Charging Scheme. D4012_SewerageSPLPOrgId The Organisation ID of an LP. Provided to SW in connection with the Vacancy Admin Charging Scheme. 																		
<p>namespace</p>	<p>urn:bridgeall-com:cmaservice:data:v3</p>																		
<p>type</p>	<p>T034.2_VacSchemeGraceEndNotification</p>																		
<p>properties</p>	<p>isRef 0 content complex</p>																		
<p>children</p>	<p>D2001_SPID D4006_EffectiveFrom D4007_DateOfEvidence D4003_Comment D4004_ReturnCode D4011_WaterSPLPOrgId D4012_SewerageSPLPOrgId</p>																		
<p>attributes</p>	<table border="1"> <thead> <tr> <th>Name</th> <th>Type</th> <th>Use</th> <th>Default</th> <th>Fixed</th> <th>annotation</th> </tr> </thead> <tbody> <tr> <td>MID</td> <td>MessageIdType</td> <td>required</td> <td></td> <td></td> <td></td> </tr> <tr> <td>RelatedMID</td> <td>MessageIdType</td> <td>optional</td> <td></td> <td></td> <td></td> </tr> </tbody> </table>	Name	Type	Use	Default	Fixed	annotation	MID	MessageIdType	required				RelatedMID	MessageIdType	optional			
Name	Type	Use	Default	Fixed	annotation														
MID	MessageIdType	required																	
RelatedMID	MessageIdType	optional																	
<p>source</p>	<pre><xs:element name="T034.2_VacSchemeGraceEndNotification" type="T034.2_VacSchemeGraceEndNotification"/></pre>																		

element **ResponseMessagesType/T034.3_VacSchemeApplicationNotification**

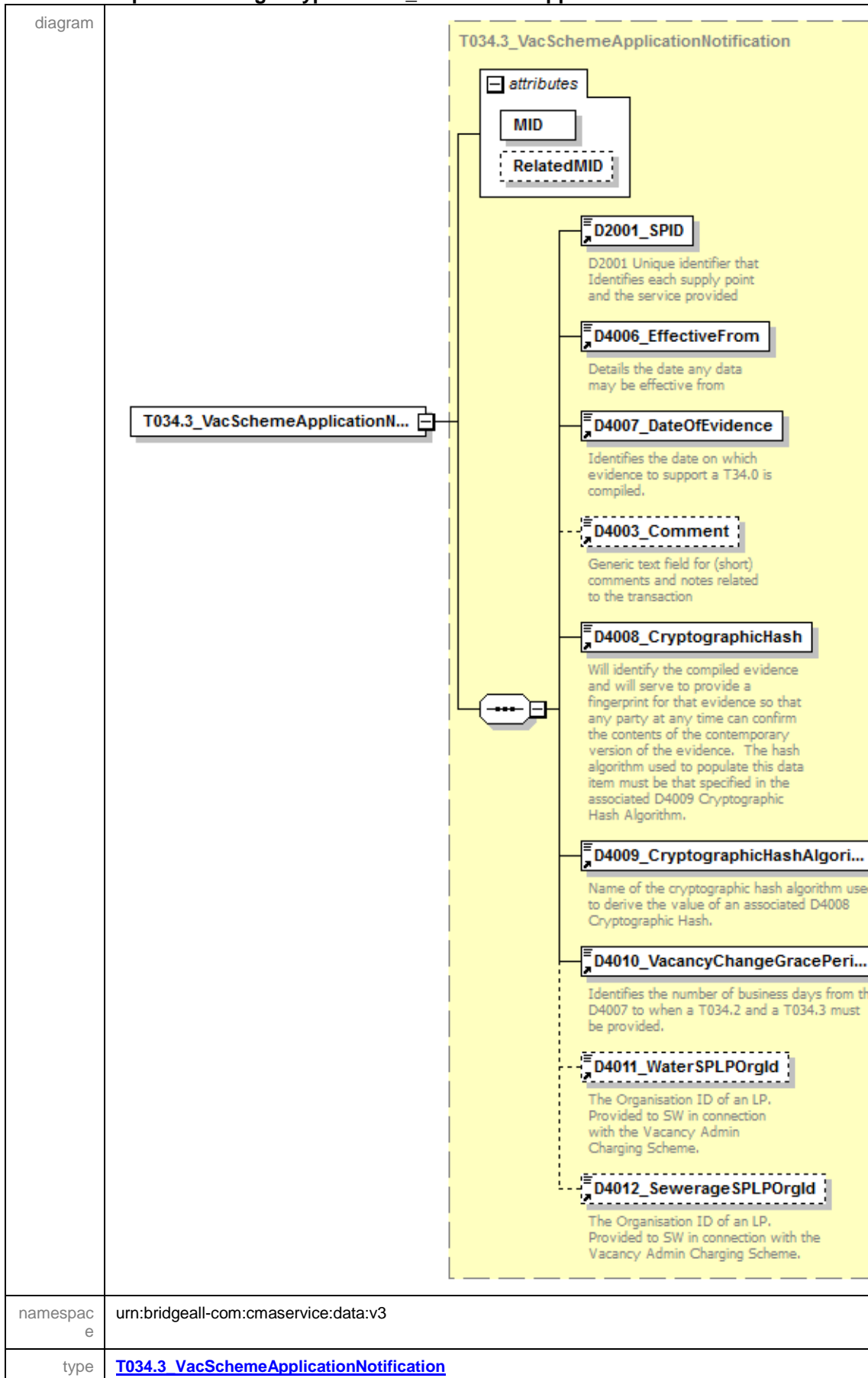

properties	isRef 0 content complex																		
children	D2001_SPID D4006_EffectiveFrom D4007_DateOfEvidence D4003_Comment D4008_CryptographicHash D4009_CryptographicHashAlgorithm D4010_VacancyChangeGracePeriod D4011_WaterSPLPOrgId D4012_SewerageSPLPOrgId																		
attributes	<table border="1"> <thead> <tr> <th>Name</th> <th>Type</th> <th>Use</th> <th>Default</th> <th>Fixed</th> <th>annotation</th> </tr> </thead> <tbody> <tr> <td>MID</td> <td>MessageIdType</td> <td>required</td> <td></td> <td></td> <td></td> </tr> <tr> <td>RelatedMID</td> <td>MessageIdType</td> <td>optional</td> <td></td> <td></td> <td></td> </tr> </tbody> </table>	Name	Type	Use	Default	Fixed	annotation	MID	MessageIdType	required				RelatedMID	MessageIdType	optional			
Name	Type	Use	Default	Fixed	annotation														
MID	MessageIdType	required																	
RelatedMID	MessageIdType	optional																	
source	<xs:element name="T034.3_VacSchemeApplicationNotification" type="T034.3_VacSchemeApplicationNotification"/>																		

element
ResponseMessagesType/T034.5_VacSchemeApplicationConfirmationOrCancellationNotification

diagram	<p>The diagram illustrates the structure of the T034.5_VacSchemeApplicationConfirmationOrCancellationNotification element. It is a complex element with the following components:</p> <ul style="list-style-type: none"> Attributes: <ul style="list-style-type: none"> MID: Required, type <code>MessageIdType</code>. RelatedMID: Optional, type <code>MessageIdType</code>. Content Elements: <ul style="list-style-type: none"> D2001_SPID: Unique identifier that identifies each supply point and the service provided. D4006_EffectiveFrom: Details the date any data may be effective from. D4007_DateOfEvidence: Identifies the date on which evidence to support a T34.0 is compiled. D2031_VacancyChangeFlag: Declares that a vacancy change application should proceed (if set to True), or should be cancelled (if set to False). D2032_LPChallengedVacancyAp...: Declares that an LP has raised a challenge against an SW vacancy change application. D4003_Comment: Generic text field for (short) comments and notes related to the transaction.
namespace	urn:bridgeall-com:cmaservice:data:v3
type	T034.5_VacSchemeApplicationConfirmationOrCancellationNotification
properties	isRef 0 content complex
children	D2001_SPID D4006_EffectiveFrom D4007_DateOfEvidence D2031_VacancyChangeFlag

	D2032_LPChallengedVacancyApplicationFlag D4003 Comment					
attributes	Name	Type	Use	Default	Fixed	annotation
	MID	MessageIdType	required			
	RelatedMID	MessageIdType	optional			
source	<pre><xs:element name="T034.5_VacSchemeApplicationConfirmationOrCancellationNotification" type="T034.5_VacSchemeApplicationConfirmationOrCancellationNotification"/></pre>					

element **ResponseMessagesType/T035.0_TradeabilityNotification**

diagram																			
namespace	urn:bridgeall-com:cmaservice:data:v3																		
type	T035.0_TradeabilityNotification																		
properties	isRef 0 content complex																		
children	D2001_SPID D2013_ConnectionDate																		
attributes	<table border="1"> <thead> <tr> <th>Name</th> <th>Type</th> <th>Use</th> <th>Default</th> <th>Fixed</th> <th>annotation</th> </tr> </thead> <tbody> <tr> <td>MID</td> <td>MessageIdType</td> <td>required</td> <td></td> <td></td> <td></td> </tr> <tr> <td>RelatedMID</td> <td>MessageIdType</td> <td>optional</td> <td></td> <td></td> <td></td> </tr> </tbody> </table>	Name	Type	Use	Default	Fixed	annotation	MID	MessageIdType	required				RelatedMID	MessageIdType	optional			
Name	Type	Use	Default	Fixed	annotation														
MID	MessageIdType	required																	
RelatedMID	MessageIdType	optional																	
source	<pre><xs:element name="T035.0_TradeabilityNotification" type="T035.0_TradeabilityNotification"/></pre>																		

element **ResponseMessageType/T035.1_TradeabilityNotification**

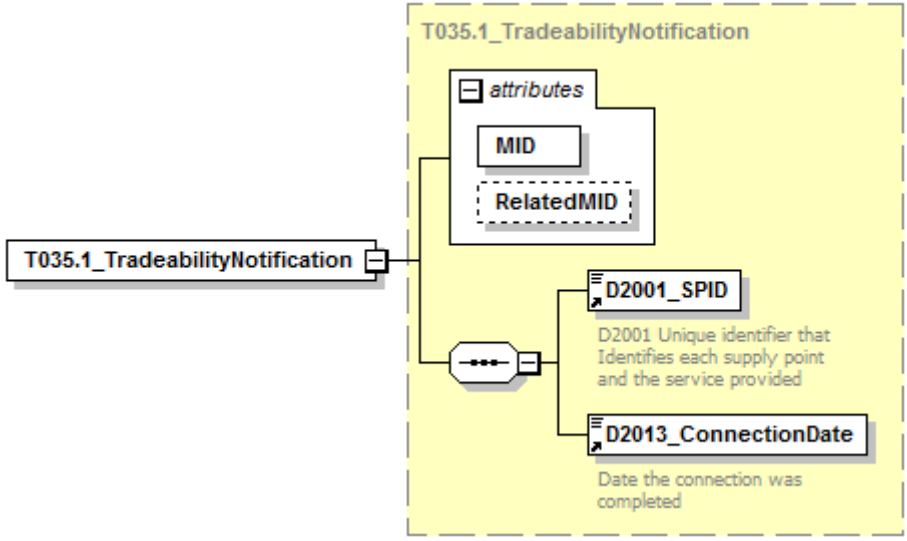
diagram																			
namespace	urn:bridgeall-com:cmaservice:data:v3																		
type	T035.1_TradeabilityNotification																		
properties	isRef 0 content complex																		
children	D2001_SPID D2013_ConnectionDate																		
attributes	<table border="1"> <thead> <tr> <th>Name</th> <th>Type</th> <th>Use</th> <th>Default</th> <th>Fixed</th> <th>annotation</th> </tr> </thead> <tbody> <tr> <td>MID</td> <td>MessageIdType</td> <td>required</td> <td></td> <td></td> <td></td> </tr> <tr> <td>RelatedMID</td> <td>MessageIdType</td> <td>optional</td> <td></td> <td></td> <td></td> </tr> </tbody> </table>	Name	Type	Use	Default	Fixed	annotation	MID	MessageIdType	required				RelatedMID	MessageIdType	optional			
Name	Type	Use	Default	Fixed	annotation														
MID	MessageIdType	required																	
RelatedMID	MessageIdType	optional																	
source	<pre><xs:element name="T035.1_TradeabilityNotification" type="T035.1_TradeabilityNotification"/></pre>																		

element **ResponseMessagesType/T036.1_MeterNetworkAssociationNotification**

<p>diagram</p>																			
<p>namespace</p>	<p>urn:bridgeall-com:cmaservice:data:v3</p>																		
<p>type</p>	<p>MeterNetworkAssociationType</p>																		
<p>properties</p>	<p>isRef 0 content complex</p>																		
<p>children</p>	<p>D2035_MainSPID D3027_MainMeterId D2036_SubSPID D3006_SubMeterId D3026_MeterNetworkAssociati... D4006_EffectiveFrom</p>																		
<p>attributes</p>	<table border="1"> <thead> <tr> <th>Name</th> <th>Type</th> <th>Use</th> <th>Default</th> <th>Fixed</th> <th>annotation</th> </tr> </thead> <tbody> <tr> <td>MID</td> <td>MessageIdType</td> <td>required</td> <td></td> <td></td> <td></td> </tr> <tr> <td>RelatedMID</td> <td>MessageIdType</td> <td>optional</td> <td></td> <td></td> <td></td> </tr> </tbody> </table>	Name	Type	Use	Default	Fixed	annotation	MID	MessageIdType	required				RelatedMID	MessageIdType	optional			
Name	Type	Use	Default	Fixed	annotation														
MID	MessageIdType	required																	
RelatedMID	MessageIdType	optional																	
<p>source</p>	<pre><xs:element name="T036.1_MeterNetworkAssociationNotification" type="MeterNetworkAssociationType"/></pre>																		

complexType **Schedule3UpdateType**

diagram																			
namespace	urn:bridgeall-com:cmaservice:data:v3																		
type	extension of MessageBody																		
properties	base MessageBody																		
children	D2001_SPID D2003_Schedule3 D4006_EffectiveFrom D6001_DPID																		
used by	elements ResponseMessagesType/T028.0_Schedule3UpdateNotification MessagesType/T028.1_Schedule3Updates/T028.1_Schedule3Update																		
attributes	<table border="1"> <thead> <tr> <th>Name</th> <th>Type</th> <th>Use</th> <th>Default</th> <th>Fixed</th> <th>annotation</th> </tr> </thead> <tbody> <tr> <td>MID</td> <td>MessageIdType</td> <td>required</td> <td></td> <td></td> <td></td> </tr> <tr> <td>RelatedMID</td> <td>MessageIdType</td> <td>optional</td> <td></td> <td></td> <td></td> </tr> </tbody> </table>	Name	Type	Use	Default	Fixed	annotation	MID	MessageIdType	required				RelatedMID	MessageIdType	optional			
Name	Type	Use	Default	Fixed	annotation														
MID	MessageIdType	required																	
RelatedMID	MessageIdType	optional																	
annotation	documentation																		
source	<pre> <xs:complexType name="Schedule3UpdateType"> <xs:annotation> <xs:documentation> </xs:documentation> </xs:annotation> <xs:complexContent> <xs:extension base="MessageBody"> <xs:sequence> <xs:element ref="D2001_SPID"/> <xs:element ref="D2003_Schedule3"/> <xs:element ref="D4006_EffectiveFrom"/> <xs:element ref="D6001_DPID"/> </xs:sequence> </xs:extension> </xs:complexContent> </xs:complexType> </pre>																		

complexType **ServiceElementUpdateNotificationType**

<p>diagram</p>																			
<p>namespace</p>	<p>urn:bridgeall-com:cmaservice:data:v3</p>																		
<p>type</p>	<p>extension of MessageBody</p>																		
<p>properties</p>	<p>base MessageBody</p>																		
<p>children</p>	<p>D2001_SPID D2015_SPIDVacant D4006_EffectiveFrom D4003_Comment</p>																		
<p>used by</p>	<p>element ResponseMessagesType/T012.2_ServiceElementUpdateNotification</p>																		
<p>attributes</p>	<table border="1"> <thead> <tr> <th>Name</th> <th>Type</th> <th>Use</th> <th>Default</th> <th>Fixed</th> <th>annotation</th> </tr> </thead> <tbody> <tr> <td>MID</td> <td>MessageIdType</td> <td>required</td> <td></td> <td></td> <td></td> </tr> <tr> <td>RelatedMID</td> <td>MessageIdType</td> <td>optional</td> <td></td> <td></td> <td></td> </tr> </tbody> </table>	Name	Type	Use	Default	Fixed	annotation	MID	MessageIdType	required				RelatedMID	MessageIdType	optional			
Name	Type	Use	Default	Fixed	annotation														
MID	MessageIdType	required																	
RelatedMID	MessageIdType	optional																	
<p>annotation</p>	<p>documentation</p>																		
<p>source</p>	<pre> <xs:complexType name="ServiceElementUpdateNotificationType"> <xs:annotation> <xs:documentation> </xs:documentation> </xs:annotation> <xs:complexContent> <xs:extension base="MessageBody"> <xs:sequence> <xs:element ref="D2001_SPID"/> <xs:element ref="D2015_SPIDVacant" minOccurs="0"/> <xs:element ref="D4006_EffectiveFrom"/> <xs:element ref="D4003_Comment"/> </xs:sequence> </xs:extension> </xs:complexContent> </xs:complexType> </pre>																		

complexType **SewerageServiceElementUpdateNotificationType**

diagram	<p>The diagram illustrates the structure of the SewerageServiceElementUpdateNotificationType complex type. It is an extension of the MessageBody type. The MessageBody extension contains two attributes: MID (required) and RelatedMID (optional). The main complex type contains five elements: D2001_SPID (required), D4006_EffectiveFrom (optional), D2016_PropertyDrainage (optional), D2017_RoadDrainage (optional), and D4003_Comment (optional). Each element has a descriptive text box next to it.</p>					
namespace	urn:bridgeall-com:cmaservice:data:v3					
type	extension of MessageBody					
properties	base MessageBody					
children	D2001_SPID D4006_EffectiveFrom D2016_PropertyDrainage D2017_RoadDrainage D4003_Comment					
used by	element ResponseMessagesType/T012.4_SewerageServiceElementUpdateNotification					
attributes	Name	Type	Use	Default	Fixed	annotation
	MID	MessageIdType	required			
	RelatedMID	MessageIdType	optional			
annotation	documentation					
source	<pre> <xs:complexType name="SewerageServiceElementUpdateNotificationType"> <xs:annotation> <xs:documentation> </xs:documentation> </xs:annotation> <xs:complexContent> <xs:extension base="MessageBody"> <xs:sequence> <xs:element ref="D2001_SPID"/> </xs:sequence> </xs:extension> </xs:complexContent> </xs:complexType> </pre>					

```

<xs:element ref="D4006_EffectiveFrom"/>
<xs:element ref="D2016_PropertyDrainage" minOccurs="0"/>
<xs:element ref="D2017_RoadDrainage" minOccurs="0"/>
<xs:element ref="D4003_Comment"/>
</xs:sequence>
</xs:extension>
</xs:complexContent>
</xs:complexType>

```

complexType **SewerageSPIDDataType**

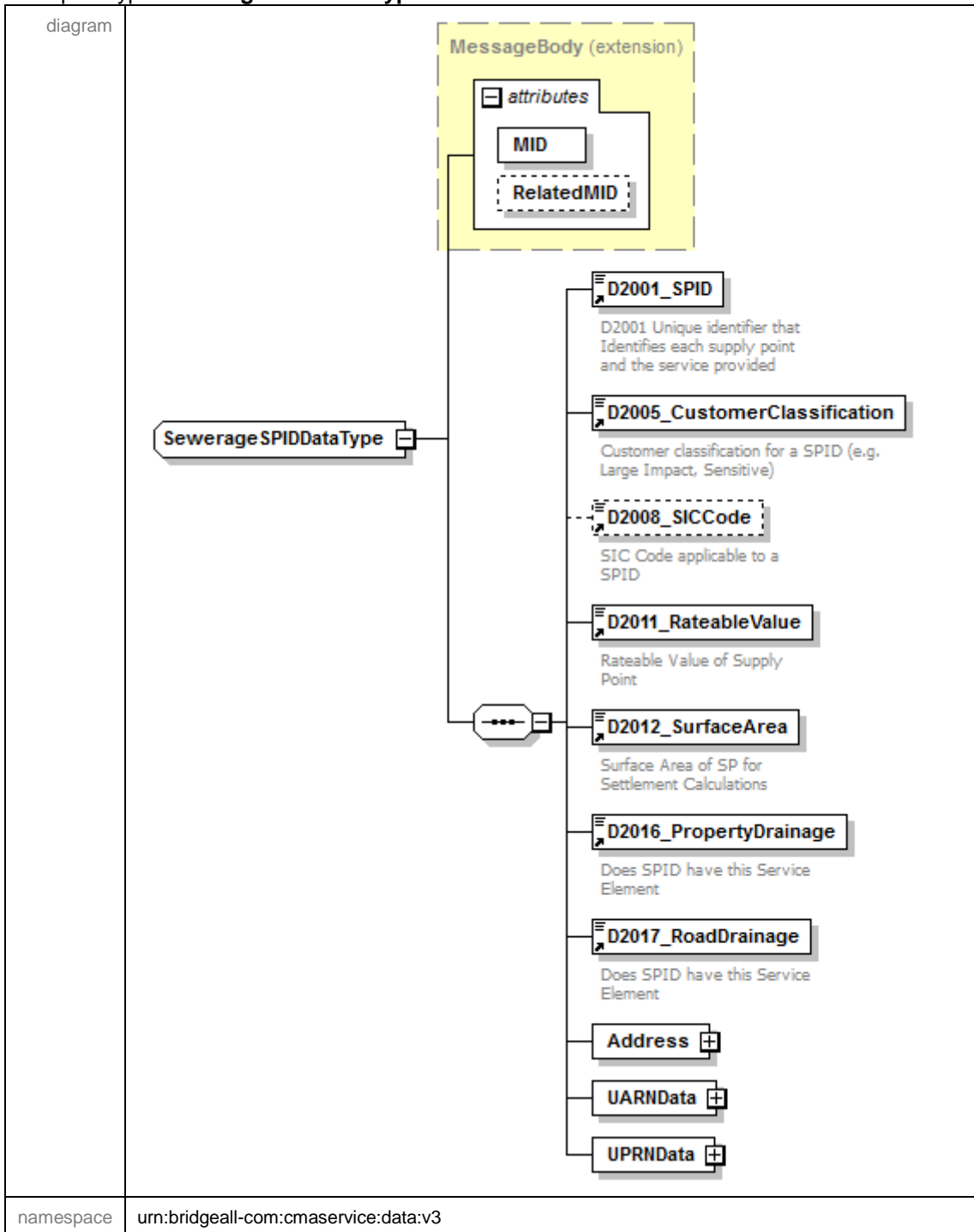

type	extension of MessageBody					
properties	base MessageBody					
children	D2001_SPID D2005_CustomerClassification D2008_SICCode D2011_RateableValue D2012_SurfaceArea D2016_PropertyDrainage D2017_RoadDrainage Address UARNDData UPRNDData					
used by	element ResponseMessagesType/T020.0_SewerageSPIDData					
attributes	Name	Type	Use	Default	Fixed	annotation
	MID	MessageIdType	required			
	RelatedMID	MessageIdType	optional			
annotation	documentation					
source	<pre> <xs:complexType name="SewerageSPIDDataType"> <xs:annotation> <xs:documentation> </xs:documentation> </xs:annotation> <xs:complexContent> <xs:extension base="MessageBody"> <xs:sequence> <xs:element ref="D2001_SPID"/> <xs:element ref="D2005_CustomerClassification"/> <xs:element ref="D2008_SICCode" minOccurs="0"/> <xs:element ref="D2011_RateableValue"/> <xs:element ref="D2012_SurfaceArea"/> <xs:element ref="D2016_PropertyDrainage"/> <xs:element ref="D2017_RoadDrainage"/> <xs:element name="Address" type="AddressType"/> <xs:element name="UARNDData" type="UARNTYPE"/> <xs:element name="UPRNDData" type="UPRNTYPE"/> </xs:sequence> </xs:extension> </xs:complexContent> </xs:complexType> </pre>					

element **SewerageSPIDData/Address**

<p>diagram</p>	
<p>namespace</p>	<p>urn:bridgeall-com:cmaservice:data:v3</p>
<p>type</p>	<p>AddressType</p>
<p>properties</p>	<p>isRef 0 content complex</p>
<p>children</p>	<p>D5001_FreeDescriptor D5002_SubBuildingName D5003_BuildingName D5004_BuildingNumber D5005_DependentThoroughfareName D5006_DependentThoroughfareDescriptor D5007_ThoroughfareName D5008_ThoroughfareDescriptor D5009_DoubleDependentLocality D5010_DependentLocality D5011_PostTown D5012_County D5013_Postcode</p>
<p>source</p>	<p><xs:element name="Address" type="AddressType"/></p>

element **SewerageSPIDData/UARNDData**

<p>diagram</p>	
<p>namespace</p>	<p>urn:bridgeall-com:cmaservice:data:v3</p>
<p>type</p>	<p>UARNTType</p>
<p>properties</p>	<p>isRef 0 content complex</p>

children	D2037 SAAReferenceNumber D2038 SAAReferenceNumberAbsenceCode
source	<code><xs:element name="UARNDData" type="UARNTYPE"/></code>

element **SewerageSPIDData/UPRNDData**

diagram	<p>The diagram illustrates the structure of the UPRNDData element. On the left, a box labeled 'UPRNDData' is connected to a central circle containing three dots. This circle is connected to a larger yellow dashed box labeled 'UPRNTYPE'. Inside the 'UPRNTYPE' box, there are two sub-elements: 'D2039_UPRN' and 'D2040_UPRNAbsenceCode', each enclosed in a dashed box.</p>
namespace	urn:bridgeall-com:cmaservice:data:v3
type	UPRNTYPE
properties	isRef 0 content complex
children	D2039 UPRN D2040 UPRNAbsenceCode
source	<code><xs:element name="UPRNDData" type="UPRNTYPE"/></code>

complexType **SpecialArrangementsUpdateNotificationType**

<p>diagram</p>																			
<p>namespace</p>	<p>urn:bridgeall-com:cmaservice:data:v3</p>																		
<p>type</p>	<p>extension of MessageBody</p>																		
<p>properties</p>	<p>base MessageBody</p>																		
<p>children</p>	<p>D2001_SPID D4006_EffectiveFrom D2003_Schedule3 D2004_ExemptCustomerFlag D2041_PcentExemption D2006_29e D2007_LargeVolAgreement</p>																		
<p>used by</p>	<p>element ResponseMessagesType/T029.0_SpecialArrangementsUpdateNotification</p>																		
<p>attributes</p>	<table border="1"> <thead> <tr> <th>Name</th> <th>Type</th> <th>Use</th> <th>Default</th> <th>Fixed</th> <th>annotation</th> </tr> </thead> <tbody> <tr> <td>MID</td> <td>MessageIdType</td> <td>required</td> <td></td> <td></td> <td></td> </tr> <tr> <td>RelatedMID</td> <td>MessageIdType</td> <td>optional</td> <td></td> <td></td> <td></td> </tr> </tbody> </table>	Name	Type	Use	Default	Fixed	annotation	MID	MessageIdType	required				RelatedMID	MessageIdType	optional			
Name	Type	Use	Default	Fixed	annotation														
MID	MessageIdType	required																	
RelatedMID	MessageIdType	optional																	
<p>annotation</p>	<p>documentation</p>																		
<p>source</p>	<pre><xs:complexType name="SpecialArrangementsUpdateNotificationType"> <xs:annotation> <xs:documentation> </xs:documentation> </xs:complexType></pre>																		

```

</xs:annotation>
<xs:complexContent>
  <xs:extension base="MessageBody">
    <xs:sequence>
      <xs:element ref="D2001_SPID"/>
      <xs:element ref="D4006_EffectiveFrom"/>
      <xs:element ref="D2003_Schedule3" minOccurs="0"/>
      <xs:element ref="D2004_ExemptCustomerFlag" minOccurs="0"/>
      <xs:element ref="D2041_PcentExemption" minOccurs="0"/>
      <xs:element ref="D2006_29e" minOccurs="0"/>
      <xs:element ref="D2007_LargeVolAgreement" minOccurs="0"/>
    </xs:sequence>
  </xs:extension>
</xs:complexContent>
</xs:complexType>

```

complexType **SpecialArrangementsUpdateType**

diagram	
namespace	urn:bridgeall-com:cmaservice:data:v3
type	extension of MessageBody
properties	base MessageBody
children	D2001_SPID D4006_EffectiveFrom D2003_Schedule3 D2006_29e D2007_LargeVolAgreement
used by	element MessagesType/T029.1_SpecialArrangementsUpdates/T029.1_SpecialArrangementsUpdate

attributes	Name MID RelatedMID	Type MessageIdType MessageIdType	Use required optional	Default	Fixed	annotation
annotation	documentation					
source	<pre> <xs:complexType name="SpecialArrangementsUpdateType"> <xs:annotation> <xs:documentation> </xs:documentation> </xs:annotation> <xs:complexContent> <xs:extension base="MessageBody"> <xs:sequence> <xs:element ref="D2001_SPID"/> <xs:element ref="D4006_EffectiveFrom"/> <xs:element ref="D2003_Schedule3" minOccurs="0"/> <xs:element ref="D2006_29e" minOccurs="0"/> <xs:element ref="D2007_LargeVolAgreement" minOccurs="0"/> </xs:sequence> </xs:extension> </xs:complexContent> </xs:complexType> </pre>					

complexType T003.1_RegistrationApplicationType

diagram						
namespace	urn:bridgeall-com:cmaservice:data:v3					
type	extension of MessageBody					
properties	base MessageBody					
children	D2001_SPID D4002_RegistrationStartDate					
used by	element MessagesType/T003.1_RegistrationApplications/T003.1_RegistrationApplication					
attributes	Name MID RelatedMID	Type MessageIdType MessageIdType	Use required optional	Default	Fixed	annotation
annotation	documentation					

source	<pre><xs:complexType name="T003.1_RegistrationApplicationType"> <xs:annotation> <xs:documentation> </xs:documentation> </xs:annotation> <xs:complexContent> <xs:extension base="MessageBody"> <xs:sequence> <xs:element ref="D2001_SPID"/> <xs:element ref="D4002_RegistrationStartDate"/> </xs:sequence> </xs:extension> </xs:complexContent> </xs:complexType></pre>

complexType T004.0_NewMeterType

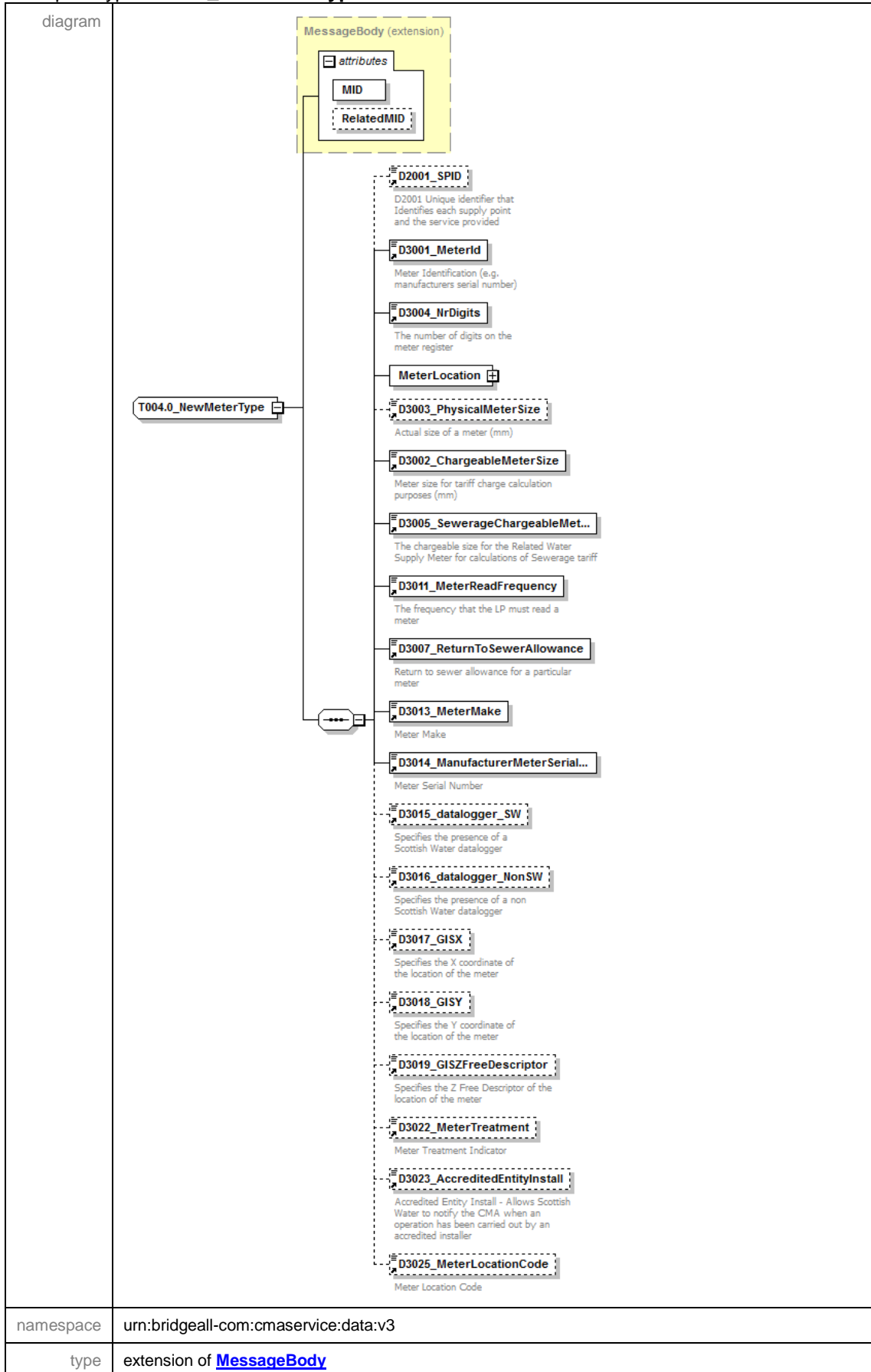

properties	base MessageBody					
children	D2001_SPID D3001_MeterId D3004_NrDigits MeterLocation D3003_PhysicalMeterSize D3002_ChargeableMeterSize D3005_SewerageChargeableMeterSize D3011_MeterReadFrequency D3007_ReturnToSewerAllowance D3013_MeterMake D3014_ManufacturerMeterSerialNr D3015_datalogger_SW D3016_datalogger_NonSW D3017_GISX D3018_GISY D3019_GISZFreeDescriptor D3022_MeterTreatment D3023_AccreditedEntityInstall D3025_MeterLocationCode					
used by	element MessagesType/T004.0_NewMeters/T004.0_NewMeter					
attributes	Name	Type	Use	Default	Fixed	annotation
	MID	MessageIdType	required			
	RelatedMID	MessageIdType	optional			
annotation	documentation					
source	<pre> <xs:complexType name="T004.0_NewMeterType"> <xs:annotation> <xs:documentation> </xs:documentation> </xs:annotation> <xs:complexContent> <xs:extension base="MessageBody"> <xs:sequence> <xs:element ref="D2001_SPID" minOccurs="0"/> <xs:element ref="D3001_MeterId"/> <xs:element ref="D3004_NrDigits"/> <xs:element name="MeterLocation" type="AddressType"/> <xs:element ref="D3003_PhysicalMeterSize" minOccurs="0"/> <xs:element ref="D3002_ChargeableMeterSize"/> <xs:element ref="D3005_SewerageChargeableMeterSize"/> <xs:element ref="D3011_MeterReadFrequency"/> <xs:element ref="D3007_ReturnToSewerAllowance"/> <xs:element ref="D3013_MeterMake"/> <xs:element ref="D3014_ManufacturerMeterSerialNr"/> <xs:element ref="D3015_datalogger_SW" minOccurs="0"/> <xs:element ref="D3016_datalogger_NonSW" minOccurs="0"/> <xs:element ref="D3017_GISX" minOccurs="0"/> <xs:element ref="D3018_GISY" minOccurs="0"/> <xs:element ref="D3019_GISZFreeDescriptor" minOccurs="0"/> <xs:element ref="D3022_MeterTreatment" minOccurs="0"/> <xs:element ref="D3023_AccreditedEntityInstall" minOccurs="0"/> <xs:element ref="D3025_MeterLocationCode" minOccurs="0"/> </xs:sequence> </xs:extension> </xs:complexContent> </xs:complexType> </pre>					

element **T004.0_NewMeterType/MeterLocation**

<p>diagram</p>	
<p>namespace</p>	<p>urn:bridgeall-com:cmaservice:data:v3</p>
<p>type</p>	<p>AddressType</p>
<p>properties</p>	<p>isRef 0 content complex</p>
<p>children</p>	<p>D5001_FreeDescriptor D5002_SubBuildingName D5003_BuildingName D5004_BuildingNumber D5005_DependentThoroughfareName D5006_DependentThoroughfareDescriptor D5007_ThoroughfareName D5008_ThoroughfareDescriptor D5009_DoubleDependentLocality D5010_DependentLocality D5011_PostTown D5012_County D5013_Postcode</p>
<p>source</p>	<p><xs:element name="MeterLocation" type="AddressType"/></p>

complexType **T004.1_NewMeterNotificationType**

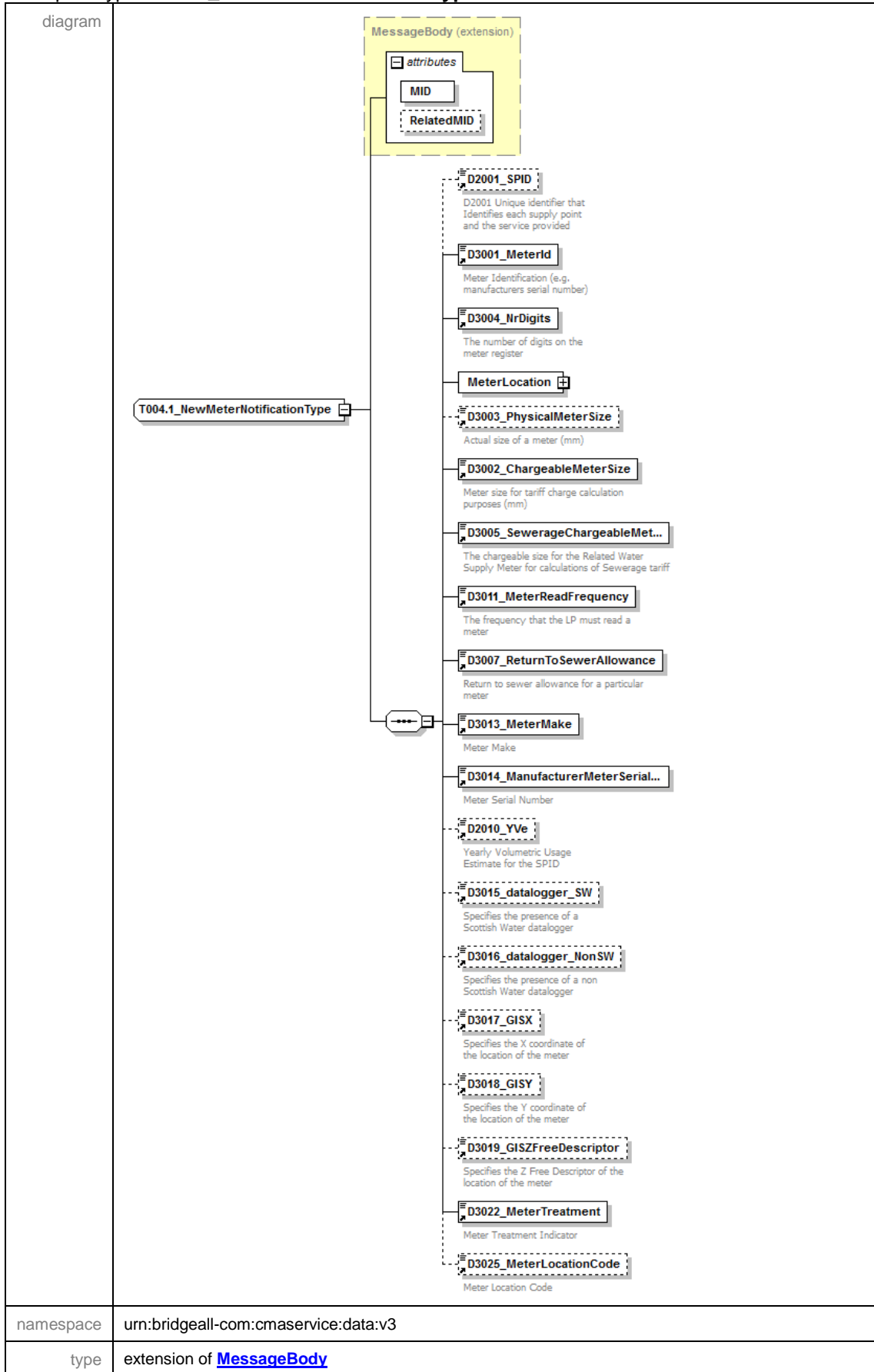

properties	base MessageBody					
children	D2001_SPID D3001_MeterId D3004_NrDigits MeterLocation D3003_PhysicalMeterSize D3002_ChargeableMeterSize D3005_SewerageChargeableMeterSize D3011_MeterReadFrequency D3007_ReturnToSewerAllowance D3013_MeterMake D3014_ManufacturerMeterSerialNr D2010_YVe D3015_datalogger_SW D3016_datalogger_NonSW D3017_GISX D3018_GISY D3019_GISZFreeDescriptor D3022_MeterTreatment D3025_MeterLocationCode					
used by	element ResponseMessagesType/T004.1_NewMeterNotification					
attributes	Name	Type	Use	Default	Fixed	annotation
	MID	MessageIdType	required			
	RelatedMID	MessageIdType	optional			
annotation	documentation					
source	<pre> <xs:complexType name="T004.1_NewMeterNotificationType"> <xs:annotation> <xs:documentation> </xs:documentation> </xs:annotation> <xs:complexContent> <xs:extension base="MessageBody"> <xs:sequence> <xs:element ref="D2001_SPID" minOccurs="0"/> <xs:element ref="D3001_MeterId"/> <xs:element ref="D3004_NrDigits"/> <xs:element name="MeterLocation" type="AddressType"/> <xs:element ref="D3003_PhysicalMeterSize" minOccurs="0"/> <xs:element ref="D3002_ChargeableMeterSize"/> <xs:element ref="D3005_SewerageChargeableMeterSize"/> <xs:element ref="D3011_MeterReadFrequency"/> <xs:element ref="D3007_ReturnToSewerAllowance"/> <xs:element ref="D3013_MeterMake"/> <xs:element ref="D3014_ManufacturerMeterSerialNr"/> <xs:element ref="D2010_YVe" minOccurs="0"/> <xs:element ref="D3015_datalogger_SW" minOccurs="0"/> <xs:element ref="D3016_datalogger_NonSW" minOccurs="0"/> <xs:element ref="D3017_GISX" minOccurs="0"/> <xs:element ref="D3018_GISY" minOccurs="0"/> <xs:element ref="D3019_GISZFreeDescriptor" minOccurs="0"/> <xs:element ref="D3022_MeterTreatment"/> <xs:element ref="D3025_MeterLocationCode" minOccurs="0"/> </xs:sequence> </xs:extension> </xs:complexContent> </xs:complexType> </pre>					

element **T004.1_NewMeterNotificationType/MeterLocation**

<p>diagram</p>	
<p>namespace</p>	<p>urn:bridgeall-com:cmaservice:data:v3</p>
<p>type</p>	<p>AddressType</p>
<p>properties</p>	<p>isRef 0 content complex</p>
<p>children</p>	<p>D5001_FreeDescriptor D5002_SubBuildingName D5003_BuildingName D5004_BuildingNumber D5005_DependentThoroughfareName D5006_DependentThoroughfareDescriptor D5007_ThoroughfareName D5008_ThoroughfareDescriptor D5009_DoubleDependentLocality D5010_DependentLocality D5011_PostTown D5012_County D5013_Postcode</p>
<p>source</p>	<p><xs:element name="MeterLocation" type="AddressType"/></p>

complexType **T004.3_VirtualMeterType**

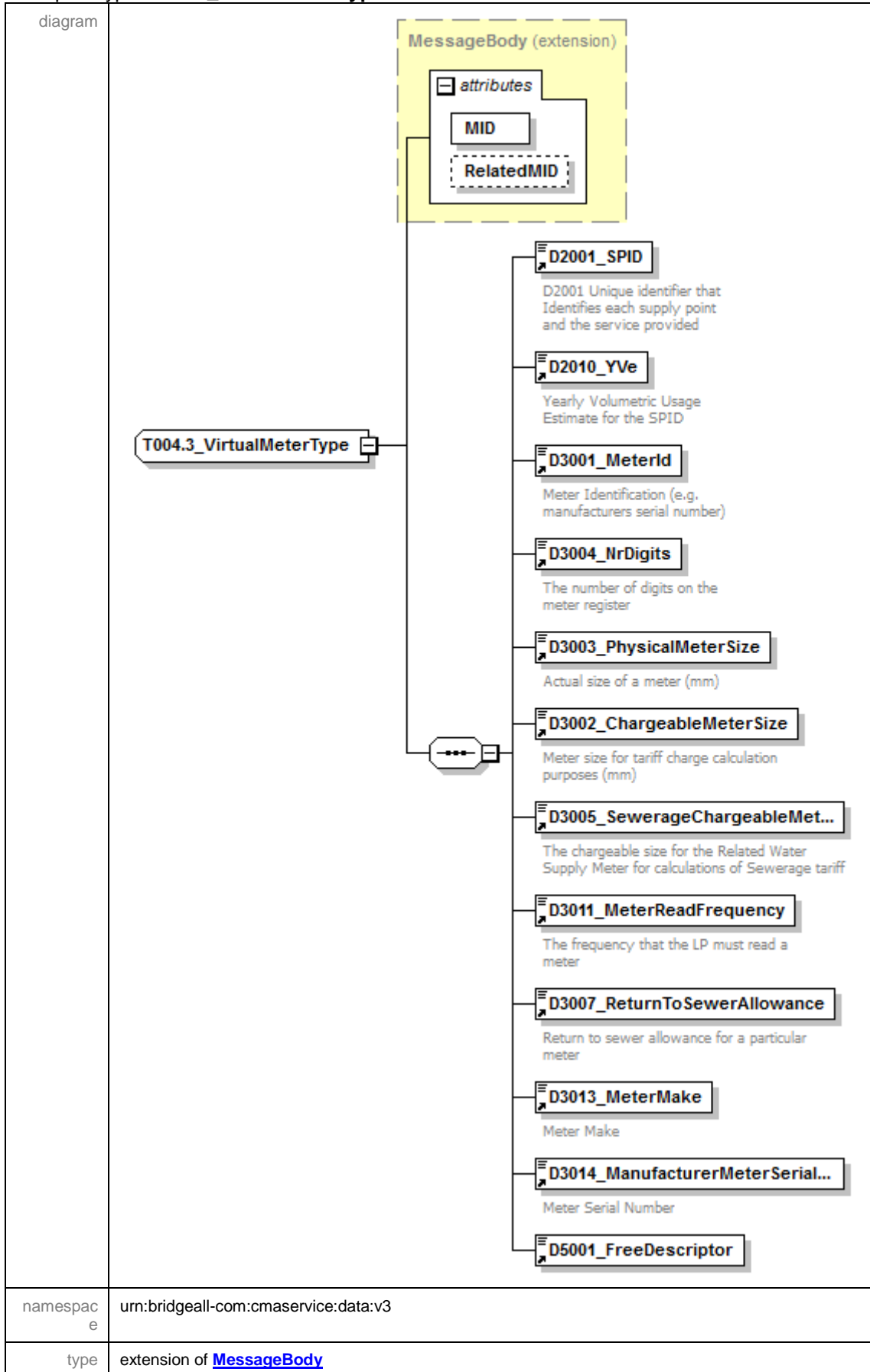

properties	base MessageBody																		
children	D2001_SPID D2010_YVe D3001_MeterId D3004_NrDigits D3003_PhysicalMeterSize D3002_ChargeableMeterSize D3005_SewerageChargeableMeterSize D3011_MeterReadFrequency D3007_ReturnToSewerAllowance D3013_MeterMake D3014_ManufacturerMeterSerialNr D5001_FreeDescriptor																		
used by	element MessagesType/T004.3_VirtualMeters/T004.3_VirtualMeter																		
attributes	<table border="1"> <thead> <tr> <th>Name</th> <th>Type</th> <th>Use</th> <th>Default</th> <th>Fixed</th> <th>annotation</th> </tr> </thead> <tbody> <tr> <td>MID</td> <td>MessageldType</td> <td>required</td> <td></td> <td></td> <td></td> </tr> <tr> <td>RelatedMID</td> <td>MessageldType</td> <td>optional</td> <td></td> <td></td> <td></td> </tr> </tbody> </table>	Name	Type	Use	Default	Fixed	annotation	MID	MessageldType	required				RelatedMID	MessageldType	optional			
Name	Type	Use	Default	Fixed	annotation														
MID	MessageldType	required																	
RelatedMID	MessageldType	optional																	
annotation	documentation																		
source	<pre> <xs:complexType name="T004.3_VirtualMeterType"> <xs:annotation> <xs:documentation> </xs:documentation> </xs:annotation> <xs:complexContent> <xs:extension base="MessageBody"> <xs:sequence> <xs:element ref="D2001_SPID"/> <xs:element ref="D2010_YVe"/> <xs:element ref="D3001_MeterId"/> <xs:element ref="D3004_NrDigits"/> <xs:element ref="D3003_PhysicalMeterSize"/> <xs:element ref="D3002_ChargeableMeterSize"/> <xs:element ref="D3005_SewerageChargeableMeterSize"/> <xs:element ref="D3011_MeterReadFrequency"/> <xs:element ref="D3007_ReturnToSewerAllowance"/> <xs:element ref="D3013_MeterMake"/> <xs:element ref="D3014_ManufacturerMeterSerialNr"/> <xs:element ref="D5001_FreeDescriptor"/> </xs:sequence> </xs:extension> </xs:complexContent> </xs:complexType> </pre>																		

complexType **T006.0_LPWaterSPIDUpdateType**

<p>diagram</p>	<p>The diagram illustrates the structure of the complexType T006.0_LPWaterSPIDUpdateType. It is an extension of the MessageBody type. The MessageBody (extension) contains two attributes: MID and RelatedMID. The complexType itself contains four elements: D2001_SPID, D2005_CustomerClassification, D2008_SICCode, and D2011_RateableValue. The elements D2005_CustomerClassification, D2008_SICCode, and D2011_RateableValue are shown with dashed borders, indicating they are optional or have a default value. The D2001_SPID element is shown with a solid border and a required use.</p>																		
<p>namespace</p>	<p>urn:bridgeall-com:cmaservice:data:v3</p>																		
<p>type</p>	<p>extension of MessageBody</p>																		
<p>properties</p>	<p>base MessageBody</p>																		
<p>children</p>	<p>D2001_SPID D2005_CustomerClassification D2008_SICCode D2011_RateableValue</p>																		
<p>used by</p>	<p>element MessagesType/T006.0_LPWaterSPIDUpdates/T006.0_LPWaterSPIDUpdate</p>																		
<p>attributes</p>	<table border="1"> <thead> <tr> <th>Name</th> <th>Type</th> <th>Use</th> <th>Default</th> <th>Fixed</th> <th>annotation</th> </tr> </thead> <tbody> <tr> <td>MID</td> <td>MessageIdType</td> <td>required</td> <td></td> <td></td> <td></td> </tr> <tr> <td>RelatedMID</td> <td>MessageIdType</td> <td>optional</td> <td></td> <td></td> <td></td> </tr> </tbody> </table>	Name	Type	Use	Default	Fixed	annotation	MID	MessageIdType	required				RelatedMID	MessageIdType	optional			
Name	Type	Use	Default	Fixed	annotation														
MID	MessageIdType	required																	
RelatedMID	MessageIdType	optional																	
<p>annotation</p>	<p>documentation</p>																		
<p>source</p>	<pre><xs:complexType name="T006.0_LPWaterSPIDUpdateType"> <xs:annotation> <xs:documentation> </xs:documentation> </xs:annotation> <xs:complexContent> <xs:extension base="MessageBody"> <xs:sequence> <xs:element ref="D2001_SPID"/> <xs:element ref="D2005_CustomerClassification" minOccurs="0"/> <xs:element ref="D2008_SICCode" minOccurs="0"/> <xs:element ref="D2011_RateableValue" minOccurs="0"/> </xs:sequence> </xs:extension> </xs:complexContent> </xs:complexType></pre>																		

complexType **T006.1_LPSewerageSPIDUpdateType**

diagram	<p>The diagram illustrates the structure of the T006.1_LPSewerageSPIDUpdateType complex type. It is an extension of the MessageBody type. The MessageBody extension is highlighted in yellow and contains an attributes container with two attributes: MID (required) and RelatedMID (optional). The main body of the complex type contains four elements: D2001_SPID (required), D2005_CustomerClassification (optional), D2008_SICCode (optional), and D20011_RateableValue (optional). Each element is accompanied by a brief description of its purpose.</p>																		
namespace	urn:bridgeall-com:cmaservice:data:v3																		
type	extension of MessageBody																		
properties	base MessageBody																		
children	D2001_SPID D2005_CustomerClassification D2008_SICCode D20011_RateableValue																		
used by	element MessagesType/T006.1_LPSewerageSPIDUpdates/T006.1_LPSewerageSPIDUpdate																		
attributes	<table border="1"> <thead> <tr> <th>Name</th> <th>Type</th> <th>Use</th> <th>Default</th> <th>Fixed</th> <th>annotation</th> </tr> </thead> <tbody> <tr> <td>MID</td> <td>MessageIdType</td> <td>required</td> <td></td> <td></td> <td></td> </tr> <tr> <td>RelatedMID</td> <td>MessageIdType</td> <td>optional</td> <td></td> <td></td> <td></td> </tr> </tbody> </table>	Name	Type	Use	Default	Fixed	annotation	MID	MessageIdType	required				RelatedMID	MessageIdType	optional			
Name	Type	Use	Default	Fixed	annotation														
MID	MessageIdType	required																	
RelatedMID	MessageIdType	optional																	
annotation	documentation																		
source	<pre><xs:complexType name="T006.1_LPSewerageSPIDUpdateType"> <xs:annotation> <xs:documentation> </xs:documentation> </xs:annotation> <xs:complexContent> <xs:extension base="MessageBody"> <xs:sequence> <xs:element ref="D2001_SPID"/> <xs:element ref="D2005_CustomerClassification" minOccurs="0"/> <xs:element ref="D2008_SICCode" minOccurs="0"/> <xs:element ref="D20011_RateableValue" minOccurs="0"/> </xs:sequence> </xs:extension> </xs:complexContent> </xs:complexType></pre>																		

complexType **T006.2_WaterSPIDUpdateType**

diagram	<p>The diagram shows the structure of the T006.2_WaterSPIDUpdateType complex type. It is an extension of the MessageBody type. The MessageBody (extension) contains an attributes container with two elements: MID (required) and RelatedMID (optional). The T006.2_WaterSPIDUpdateType contains a sequence of four elements: D2001_SPID (required), D2018_TroughsDrinkingBowls (required), D2020_OutsideTaps (required), and D2014_FarmCroft (required). The D2014_FarmCroft element has a note: "If Outside Taps or Troughs and Drinking Bowls are True, this must be used to specify farm or croft."</p>					
namespace	urn:bridgeall-com:cmaservice:data:v3					
type	extension of MessageBody					
properties	base MessageBody					
children	D2001_SPID D2018_TroughsDrinkingBowls D2020_OutsideTaps D2014_FarmCroft					
used by	element MessagesType/T006.2_WaterSPIDUpdates/T006.2_WaterSPIDUpdate					
attributes	Name	Type	Use	Default	Fixed	annotation
	MID	MessageIdType	required			
	RelatedMID	MessageIdType	optional			
annotation	documentation					
source	<pre> <xs:complexType name="T006.2_WaterSPIDUpdateType"> <xs:annotation> <xs:documentation> </xs:documentation> </xs:annotation> <xs:complexContent> <xs:extension base="MessageBody"> <xs:sequence> <xs:element ref="D2001_SPID"/> <xs:element ref="D2018_TroughsDrinkingBowls"/> <xs:element ref="D2020_OutsideTaps"/> <xs:element ref="D2014_FarmCroft"/> </xs:sequence> </xs:extension> </xs:complexContent> </xs:complexType> </pre>					

```

</xs:sequence>
</xs:extension>
</xs:complexContent>
</xs:complexType>

```

complexType **T006.3_SewerageSPIDUpdateType**

diagram						
namespace	urn:bridgeall-com:cmaservice:data:v3					
type	extension of MessageBody					
properties	base MessageBody					
children	D2001_SPID D2016_PropertyDrainage D2017_RoadDrainage					
used by	element MessagesType/T006.3_SewerageSPIDUpdates/T006.3_SewerageSPIDUpdate					
attributes	Name	Type	Use	Default	Fixed	annotation
	MID	MessageIdType	required			
	RelatedMID	MessageIdType	optional			
annotation	documentation					
source	<pre> <xs:complexType name="T006.3_SewerageSPIDUpdateType"> <xs:annotation> <xs:documentation> </xs:documentation> </xs:annotation> <xs:complexContent> <xs:extension base="MessageBody"> <xs:sequence> <xs:element ref="D2001_SPID"/> <xs:element ref="D2016_PropertyDrainage"/> <xs:element ref="D2017_RoadDrainage"/> </xs:sequence> </xs:extension> </xs:complexContent> </pre>					

</xs:complexType>

complexType T006.4_WaterSPIDNotificationType

diagram						
namespace	urn:bridgeall-com:cmaservice:data:v3					
type	extension of MessageBody					
properties	base MessageBody					
children	D2001_SPID D2018_TroughsDrinkingBowls D2020_OutsideTaps D2011_RateableValue D2014_FarmCroft					
used by	element ResponseMessagesType/T006.4_WaterSPIDNotification					
attributes	Name	Type	Use	Default	Fixed	annotation
	MID	MessageIdType	required			
	RelatedMID	MessageIdType	optional			
annotation	documentation					
source	<pre><xs:complexType name="T006.4_WaterSPIDNotificationType"> <xs:annotation> <xs:documentation> </xs:documentation> </xs:annotation> <xs:complexContent></pre>					

```

<xs:extension base="MessageBody">
  <xs:sequence>
    <xs:element ref="D2001_SPID"/>
    <xs:element ref="D2018_TroughsDrinkingBowls"/>
    <xs:element ref="D2020_OutsideTaps"/>
    <xs:element ref="D2011_RateableValue"/>
    <xs:element ref="D2014_FarmCroft"/>
  </xs:sequence>
</xs:extension>
</xs:complexContent>
</xs:complexType>

```

complexType **T006.5_SewerageSPIDNotificationType**

diagram						
namespace	urn:bridgeall-com:cmaservice:data:v3					
type	extension of MessageBody					
properties	base MessageBody					
children	D2001_SPID D2016_PropertyDrainage D2017_RoadDrainage D2011_RateableValue					
used by	element ResponseMessagesType/T006.5_SewerageSPIDNotification					
attributes	Name	Type	Use	Default	Fixed	annotation
	MID	MessageIdType	required			
	RelatedMID	MessageIdType	optional			
annotation	documentation					
source	<xs:complexType name="T006.5_SewerageSPIDNotificationType"> <xs:annotation> <xs:documentation>					

```

</xs:documentation>
</xs:annotation>
<xs:complexContent>
  <xs:extension base="MessageBody">
    <xs:sequence>
      <xs:element ref="D2001_SPID"/>
      <xs:element ref="D2016_PropertyDrainage"/>
      <xs:element ref="D2017_RoadDrainage"/>
      <xs:element ref="D2011_RateableValue"/>
    </xs:sequence>
  </xs:extension>
</xs:complexContent>
</xs:complexType>

```

complexType T007.0_WaterConnectionCompleteType

diagram						
namespace	urn:bridgeall-com:cmaservice:data:v3					
type	extension of MessageBody					
properties	base MessageBody					
children	D2001_SPID D2013_ConnectionDate D2033_AccreditedEntityInstall					
used by	element MessagesType/T007.0_WaterConnectionCompletes/T007.0_WaterConnectionComplete					
attributes	Name	Type	Use	Default	Fixed	annotation
	MID	MessageIdType	required			
	RelatedMID	MessageIdType	optional			
annotation	documentation					
source	<pre> <xs:complexType name="T007.0_WaterConnectionCompleteType"> <xs:annotation> <xs:documentation> </xs:documentation> </pre>					

```

</xs:annotation>
<xs:complexContent>
  <xs:extension base="MessageBody">
    <xs:sequence>
      <xs:element ref="D2001_SPID"/>
      <xs:element ref="D2013_ConnectionDate"/>
      <xs:element ref="D2033_AccreditedEntityInstall" minOccurs="0"/>
    </xs:sequence>
  </xs:extension>
</xs:complexContent>
</xs:complexType>

```

complexType **T009.4_NotificationType**

diagram						
namespace	urn:bridgeall-com:cmaservice:data:v3					
type	extension of MessageBody					
properties	base MessageBody					
children	D1009_DuplicateMessageID D4004_ReturnCode					
used by	element ResponseMessagesType/T009.4_Notification					
attributes	Name	Type	Use	Default	Fixed	annotation
	MID	MessageIdType	required			
	RelatedMID	MessageIdType	optional			
annotation	documentation					
source	<pre> <xs:complexType name="T009.4_NotificationType"> <xs:annotation> <xs:documentation> </xs:documentation> </xs:annotation> <xs:complexContent> <xs:extension base="MessageBody"> <xs:sequence> <xs:element ref="D1009_DuplicateMessageID"/> <xs:element ref="D4004_ReturnCode"/> </xs:sequence> </xs:extension> </xs:complexContent> </pre>					

</xs:complexType>

complexType T012.0_MiscSPIDUpdateType

diagram						
namespace	urn:bridgeall-com:cmaservice:data:v3					
type	extension of MessageBody					
properties	base MessageBody					
children	D2001_SPID Address D2005_CustomerClassification D4003_Comment D4006_EffectiveFrom D2008_SICCode					
used by	element MessagesType/T012.0_MiscSPIDUpdates/T012.0_MiscSPIDUpdate					
attributes	Name	Type	Use	Default	Fixed	annotation
	MID	MessageIdType	required			
	RelatedMID	MessageIdType	optional			
annotation	documentation					
source	<pre><xs:complexType name="T012.0_MiscSPIDUpdateType"> <xs:annotation> <xs:documentation> </xs:documentation> </xs:annotation> </xs:complexType></pre>					

	<pre> <xs:extension base="MessageBody"> <xs:sequence> <xs:element ref="D2001_SPID"/> <xs:element name="Address" type="AddressType" minOccurs="0"/> <xs:element ref="D2005_CustomerClassification" minOccurs="0"/> <xs:element ref="D4003_Comment"/> <xs:element ref="D4006_EffectiveFrom"/> <xs:element ref="D2008_SICCode" minOccurs="0"/> </xs:sequence> </xs:extension> </xs:complexContent> </xs:complexType> </pre>
--	--

element **T012.0_MiscSPIDUpdateType/Address**

diagram									
namespace	urn:bridgeall-com:cmaservice:data:v3								
type	AddressType								
properties	<table border="0"> <tr><td>isRef</td><td>0</td></tr> <tr><td>minOcc</td><td>0</td></tr> <tr><td>maxOcc</td><td>1</td></tr> <tr><td>content</td><td>complex</td></tr> </table>	isRef	0	minOcc	0	maxOcc	1	content	complex
isRef	0								
minOcc	0								
maxOcc	1								
content	complex								
children	D5001_FreeDescriptor D5002_SubBuildingName D5003_BuildingName D5004_BuildingNumber D5005_DependentThoroughfareName D5006_DependentThoroughfareDescriptor D5007_ThoroughfareName D5008_ThoroughfareDescriptor D5009_DoubleDependentLocality D5010_DependentLocality D5011_PostTown D5012_County D5013_Postcode								
source	<code><xs:element name="Address" type="AddressType" minOccurs="0"/></code>								

complexType T012.1_ServiceElementUpdateType

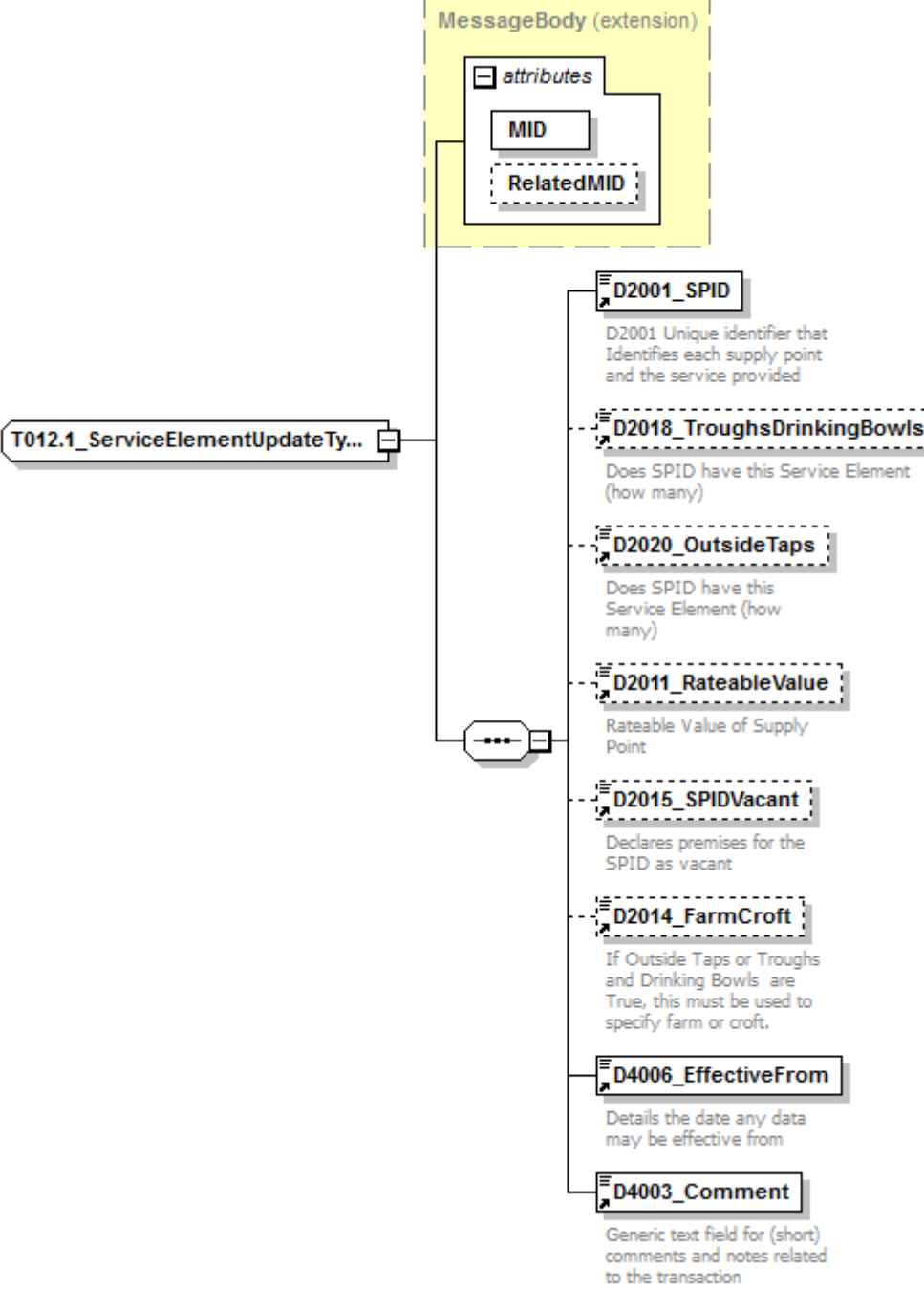
<p>diagram</p>													
<p>namespace</p>	<p>urn:bridgeall-com:cmaservice:data:v3</p>												
<p>type</p>	<p>extension of MessageBody</p>												
<p>properties</p>	<p>base MessageBody</p>												
<p>children</p>	<p>D2001_SPID D2018_TroughsDrinkingBowls D2020_OutsideTaps D2011_RateableValue D2015_SPIDVacant D2014_FarmCroft D4006_EffectiveFrom D4003_Comment</p>												
<p>used by</p>	<p>element MessagesType/T012.1_ServiceElementUpdates/T012.1_ServiceElementUpdate</p>												
<p>attributes</p>	<table border="1"> <thead> <tr> <th>Name</th> <th>Type</th> <th>Use</th> <th>Default</th> <th>Fixed</th> <th>annotation</th> </tr> </thead> <tbody> <tr> <td>MID</td> <td>MessageIdType</td> <td>required</td> <td></td> <td></td> <td></td> </tr> </tbody> </table>	Name	Type	Use	Default	Fixed	annotation	MID	MessageIdType	required			
Name	Type	Use	Default	Fixed	annotation								
MID	MessageIdType	required											

	RelatedMID MessageIdType optional
annotation	documentation
source	<pre> <xs:complexType name="T012.1_ServiceElementUpdateType"> <xs:annotation> <xs:documentation> </xs:documentation> </xs:annotation> <xs:complexContent> <xs:extension base="MessageBody"> <xs:sequence> <xs:element ref="D2001_SPID"/> <xs:element ref="D2018_TroughsDrinkingBowls" minOccurs="0"/> <xs:element ref="D2020_OutsideTaps" minOccurs="0"/> <xs:element ref="D2011_RateableValue" minOccurs="0"/> <xs:element ref="D2015_SPIDVacant" minOccurs="0"/> <xs:element ref="D2014_FarmCroft" minOccurs="0"/> <xs:element ref="D4006_EffectiveFrom"/> <xs:element ref="D4003_Comment"/> </xs:sequence> </xs:extension> </xs:complexContent> </xs:complexType> </pre>

complexType T012.3_SewerageServiceElementUpdateType

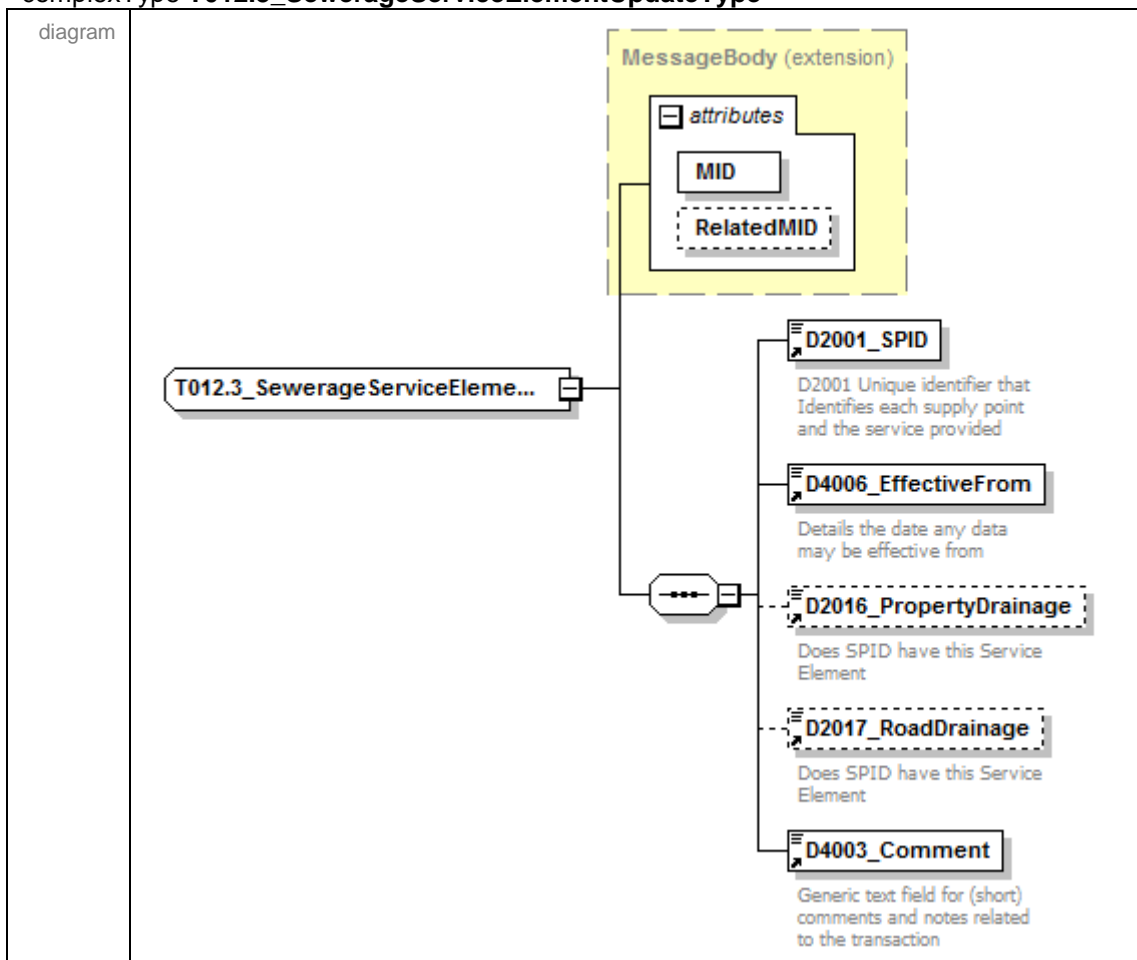

namespace	urn:bridgeall-com:cmaservice:data:v3					
type	extension of MessageBody					
properties	base MessageBody					
children	D2001_SPID D4006_EffectiveFrom D2016_PropertyDrainage D2017_RoadDrainage D4003_Comment					
used by	element MessagesType/T012.3_SewerageServiceElementUpdates/T012.3_SewerageServiceElementUpdate					
attributes	Name	Type	Use	Default	Fixed	annotation
	MID	MessageldType	required			
	RelatedMID	MessageldType	optional			
annotation	documentation					
source	<pre> <xs:complexType name="T012.3_SewerageServiceElementUpdateType"> <xs:annotation> <xs:documentation> </xs:documentation> </xs:annotation> <xs:complexContent> <xs:extension base="MessageBody"> <xs:sequence> <xs:element ref="D2001_SPID"/> <xs:element ref="D4006_EffectiveFrom"/> <xs:element ref="D2016_PropertyDrainage" minOccurs="0"/> <xs:element ref="D2017_RoadDrainage" minOccurs="0"/> <xs:element ref="D4003_Comment"/> </xs:sequence> </xs:extension> </xs:complexContent> </xs:complexType> </pre>					

complexType T016.0_UnmeasureableDeclarationType

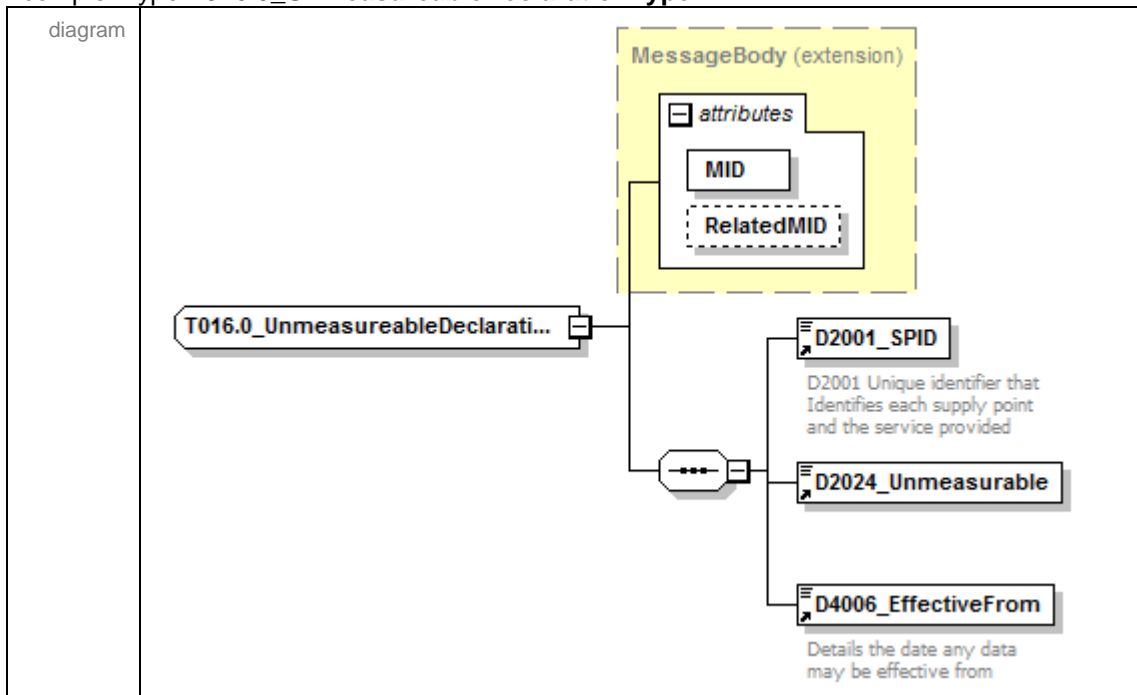

namespace	urn:bridgeall-com:cmaservice:data:v3					
type	extension of MessageBody					
properties	base MessageBody					
children	D2001_SPID D2024_Unmeasurable D4006_EffectiveFrom					
used by	elements MessagesType/T016.0_UnmeasurableDeclarations/T016.0_UnmeasurableDeclaration ResponseMessagesType/T016.1_UnmeasurableNotification					
attributes	Name	Type	Use	Default	Fixed	annotation
	MID	MessageIdType	required			
	RelatedMID	MessageIdType	optional			
annotation	documentation					
source	<pre> <xs:complexType name="T016.0_UnmeasurableDeclarationType"> <xs:annotation> <xs:documentation> </xs:documentation> </xs:annotation> <xs:complexContent> <xs:extension base="MessageBody"> <xs:sequence> <xs:element ref="D2001_SPID"/> <xs:element ref="D2024_Unmeasurable"/> <xs:element ref="D4006_EffectiveFrom"/> </xs:sequence> </xs:extension> </xs:complexContent> </xs:complexType> </pre>					

complexType T032.0_CreateUpdateCustomerNameType

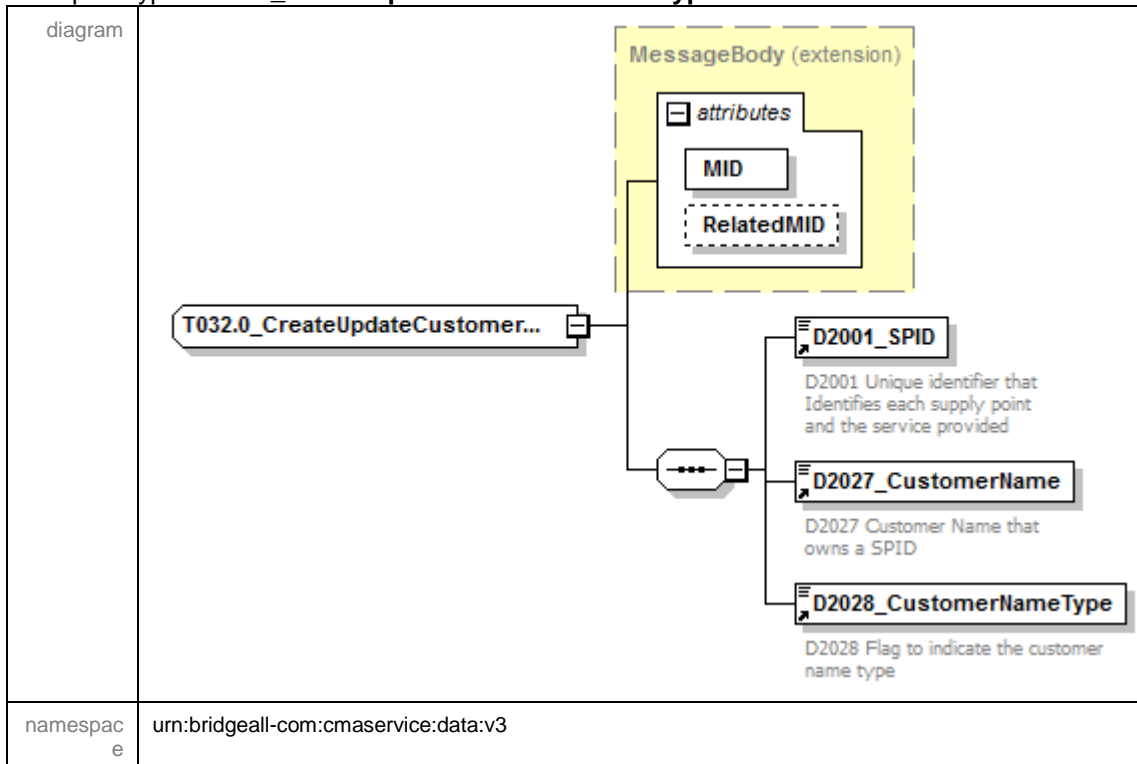

type	extension of MessageBody					
properties	base MessageBody					
children	D2001_SPID D2027_CustomerName D2028_CustomerNameType					
used by	element MessagesType/T032.0_CreateUpdateCustomerName/T032.0_CreateUpdateCustomerName					
attributes	Name	Type	Use	Default	Fixed	annotation
	MID	MessageIdType	required			
	RelatedMID	MessageIdType	optional			
annotation	documentation					
source	<pre> <xs:complexType name="T032.0_CreateUpdateCustomerNameType"> <xs:annotation> <xs:documentation> </xs:documentation> </xs:annotation> <xs:complexContent> <xs:extension base="MessageBody"> <xs:sequence> <xs:element ref="D2001_SPID"/> <xs:element ref="D2027_CustomerName"/> <xs:element ref="D2028_CustomerNameType"/> </xs:sequence> </xs:extension> </xs:complexContent> </xs:complexType> </pre>					

complexType T032.1_CustomerNameUpdatedType

diagram	
namespace	urn:bridgeall-com:cmaservice:data:v3
type	extension of MessageBody
properties	base MessageBody

children	D2001_SPID D2027_CustomerName D2028_CustomerNameType																		
used by	element ResponseMessagesType/T032.1_CustomerNameUpdated																		
attributes	<table border="1"> <thead> <tr> <th>Name</th> <th>Type</th> <th>Use</th> <th>Default</th> <th>Fixed</th> <th>annotation</th> </tr> </thead> <tbody> <tr> <td>MID</td> <td>MessageIdType</td> <td>required</td> <td></td> <td></td> <td></td> </tr> <tr> <td>RelatedMID</td> <td>MessageIdType</td> <td>optional</td> <td></td> <td></td> <td></td> </tr> </tbody> </table>	Name	Type	Use	Default	Fixed	annotation	MID	MessageIdType	required				RelatedMID	MessageIdType	optional			
Name	Type	Use	Default	Fixed	annotation														
MID	MessageIdType	required																	
RelatedMID	MessageIdType	optional																	
annotation	documentation																		
source	<pre><xs:complexType name="T032.1_CustomerNameUpdatedType"> <xs:annotation> <xs:documentation> </xs:documentation> </xs:annotation> <xs:complexContent> <xs:extension base="MessageBody"> <xs:sequence> <xs:element ref="D2001_SPID"/> <xs:element ref="D2027_CustomerName"/> <xs:element ref="D2028_CustomerNameType"/> </xs:sequence> </xs:extension> </xs:complexContent> </xs:complexType></pre>																		

complexType T033.0_MeteredBuilding

diagram	
namespace	urn:bridgeall-com:cmaservice:data:v3
type	extension of MessageBody
properties	base MessageBody

children	D2001_SPID D2029_MeteredBuildingWater D2030_MeteredBuildingWaterEffectiveDate					
used by	element	MessagesType/T033.0_MeteredBuildings/T033.0_MeteredBuilding				
attributes	Name	Type	Use	Default	Fixed	annotation
	MID	MessageIdType	required			
	RelatedMID	MessageIdType	optional			
annotation	documentation					
source	<pre> <xs:complexType name="T033.0_MeteredBuilding"> <xs:annotation> <xs:documentation> </xs:documentation> </xs:annotation> <xs:complexContent> <xs:extension base="MessageBody"> <xs:sequence> <xs:element ref="D2001_SPID"/> <xs:element ref="D2029_MeteredBuildingWater"/> <xs:element ref="D2030_MeteredBuildingWaterEffectiveDate"/> </xs:sequence> </xs:extension> </xs:complexContent> </xs:complexType> </pre>					

complexType T033.1_MeteredBuildingUpdate

diagram	<p>The diagram illustrates the structure of the <code>T033.1_MeteredBuildingUpdate</code> complex type. It is an extension of the <code>MessageBody</code> type. The <code>MessageBody</code> type has two attributes: <code>MID</code> (required) and <code>RelatedMID</code> (optional). The <code>T033.1_MeteredBuildingUpdate</code> type contains three child elements: <code>D2001_SPID</code>, <code>D2029_MeteredBuildingWater</code>, and <code>D2030_MeteredBuildingWaterEff...</code>.</p> <p>D2001_SPID D2001 Unique identifier that Identifies each supply point and the service provided</p> <p>D2029_MeteredBuildingWater D2029 Flag to indicate if the site is a metered building construction site</p> <p>D2030_MeteredBuildingWaterEff... D2030 Date when the SPID became a metered building construction site (if D2029 = True) or was no longer a metered building construction site (if D2029 = False)</p>
namespace	urn:bridgeall-com:cmaservice:data:v3
type	extension of MessageBody
properties	base <code>MessageBody</code>

children	D2001_SPID D2029_MeteredBuildingWater D2030_MeteredBuildingWaterEffectiveDate					
used by	element ResponseMessagesType/T033.1_MeteredBuildingUpdate					
attributes	Name	Type	Use	Default	Fixed	annotation
	MID	MessageIdType	required			
	RelatedMID	MessageIdType	optional			
annotation	documentation					
source	<pre> <xs:complexType name="T033.1_MeteredBuildingUpdate"> <xs:annotation> <xs:documentation> </xs:documentation> </xs:annotation> <xs:complexContent> <xs:extension base="MessageBody"> <xs:sequence> <xs:element ref="D2001_SPID"/> <xs:element ref="D2029_MeteredBuildingWater"/> <xs:element ref="D2030_MeteredBuildingWaterEffectiveDate"/> </xs:sequence> </xs:extension> </xs:complexContent> </xs:complexType> </pre>					

complexType **T034.0_VacSchemeApplication**

<p>diagram</p>	<p>T034.0_VacSchemeApplication</p> <p>MessageBody (extension)</p> <ul style="list-style-type: none"> attributes <ul style="list-style-type: none"> MID RelatedMID D2001_SPID D2001 Unique identifier that Identifies each supply point and the service provided D4006_EffectiveFrom Details the date any data may be effective from D4007_DateOfEvidence Identifies the date on which evidence to support a T34.0 is compiled. D4003_Comment Generic text field for (short) comments and notes related to the transaction D4008_CryptographicHash Will identify the compiled evidence and will serve to provide a fingerprint for that evidence so that any party at any time can confirm the contents of the contemporary version of the evidence. The hash algorithm used to populate this data item must be that specified in the associated D4009 Cryptographic Hash Algorithm. D4009_CryptographicHashAlgori... Name of the cryptographic hash algorithm use to derive the value of an associated D4008 Cryptographic Hash. 																		
<p>namespace</p>	<p>urn:bridgeall-com:cmaservice:data:v3</p>																		
<p>type</p>	<p>extension of MessageBody</p>																		
<p>properties</p>	<p>base MessageBody</p>																		
<p>children</p>	<p>D2001_SPID D4006_EffectiveFrom D4007_DateOfEvidence D4003_Comment D4008_CryptographicHash D4009_CryptographicHashAlgorithm</p>																		
<p>used by</p>	<p>element MessagesType/T034.0_VacSchemeApplications/T034.0_VacSchemeApplication</p>																		
<p>attributes</p>	<table border="1"> <thead> <tr> <th>Name</th> <th>Type</th> <th>Use</th> <th>Default</th> <th>Fixed</th> <th>annotation</th> </tr> </thead> <tbody> <tr> <td>MID</td> <td>MessageIdType</td> <td>required</td> <td></td> <td></td> <td></td> </tr> <tr> <td>RelatedMID</td> <td>MessageIdType</td> <td>optional</td> <td></td> <td></td> <td></td> </tr> </tbody> </table>	Name	Type	Use	Default	Fixed	annotation	MID	MessageIdType	required				RelatedMID	MessageIdType	optional			
Name	Type	Use	Default	Fixed	annotation														
MID	MessageIdType	required																	
RelatedMID	MessageIdType	optional																	
<p>annotation</p>	<p>documentation</p>																		

source	<pre> <xs:complexType name="T034.0_VacSchemeApplication"> <xs:annotation> <xs:documentation> </xs:documentation> </xs:annotation> <xs:complexContent> <xs:extension base="MessageBody"> <xs:sequence> <xs:element ref="D2001_SPID"/> <xs:element ref="D4006_EffectiveFrom"/> <xs:element ref="D4007_DateOfEvidence"/> <xs:element ref="D4003_Comment" minOccurs="0"/> <xs:element ref="D4008_CryptographicHash"/> <xs:element ref="D4009_CryptographicHashAlgorithm"/> </xs:sequence> </xs:extension> </xs:complexContent> </xs:complexType> </pre>
--------	---

complexType **T034.1_VacSchemeGracePeriodNotification**

diagram	<p>The diagram illustrates the structure of the complex type T034.1_VacSchemeGracePeriodNotification. It is shown as an extension of the MessageBody type. The MessageBody extension is highlighted in yellow and contains two attributes: MID and RelatedMID. The main complex type contains a sequence of elements: D2001_SPID, D4006_EffectiveFrom, D4007_DateOfEvidence, D4003_Comment (indicated as optional with a dashed border), and D4010_VacancyChangeGracePe.</p> <ul style="list-style-type: none"> D2001_SPID: D2001 Unique identifier that Identifies each supply point and the service provided D4006_EffectiveFrom: Details the date any data may be effective from D4007_DateOfEvidence: Identifies the date on which evidence to support a T34.0 is compiled. D4003_Comment: Generic text field for (short) comments and notes related to the transaction D4010_VacancyChangeGracePe: Identifies the number of business days from D4007 to when a T034.2 and a T034.3 m be provided.
namespace	urn:bridgeall-com:cmaservice:data:v3
type	extension of MessageBody

properties	base MessageBody					
children	D2001_SPID D4006_EffectiveFrom D4007_DateOfEvidence D4003_Comment D4010_VacancyChangeGracePeriod					
used by	element ResponseMessagesType/T034.1_VacSchemeGracePeriodNotification					
attributes	Name	Type	Use	Default	Fixed	annotation
	MID	MessageIdType	required			
	RelatedMID	MessageIdType	optional			
annotation	documentation					
source	<pre> <xs:complexType name="T034.1_VacSchemeGracePeriodNotification"> <xs:annotation> <xs:documentation> </xs:documentation> </xs:annotation> <xs:complexContent> <xs:extension base="MessageBody"> <xs:sequence> <xs:element ref="D2001_SPID"/> <xs:element ref="D4006_EffectiveFrom"/> <xs:element ref="D4007_DateOfEvidence"/> <xs:element ref="D4003_Comment" minOccurs="0"/> <xs:element ref="D4010_VacancyChangeGracePeriod"/> </xs:sequence> </xs:extension> </xs:complexContent> </xs:complexType> </pre>					

complexType **T034.2_VacSchemeGraceEndNotification**

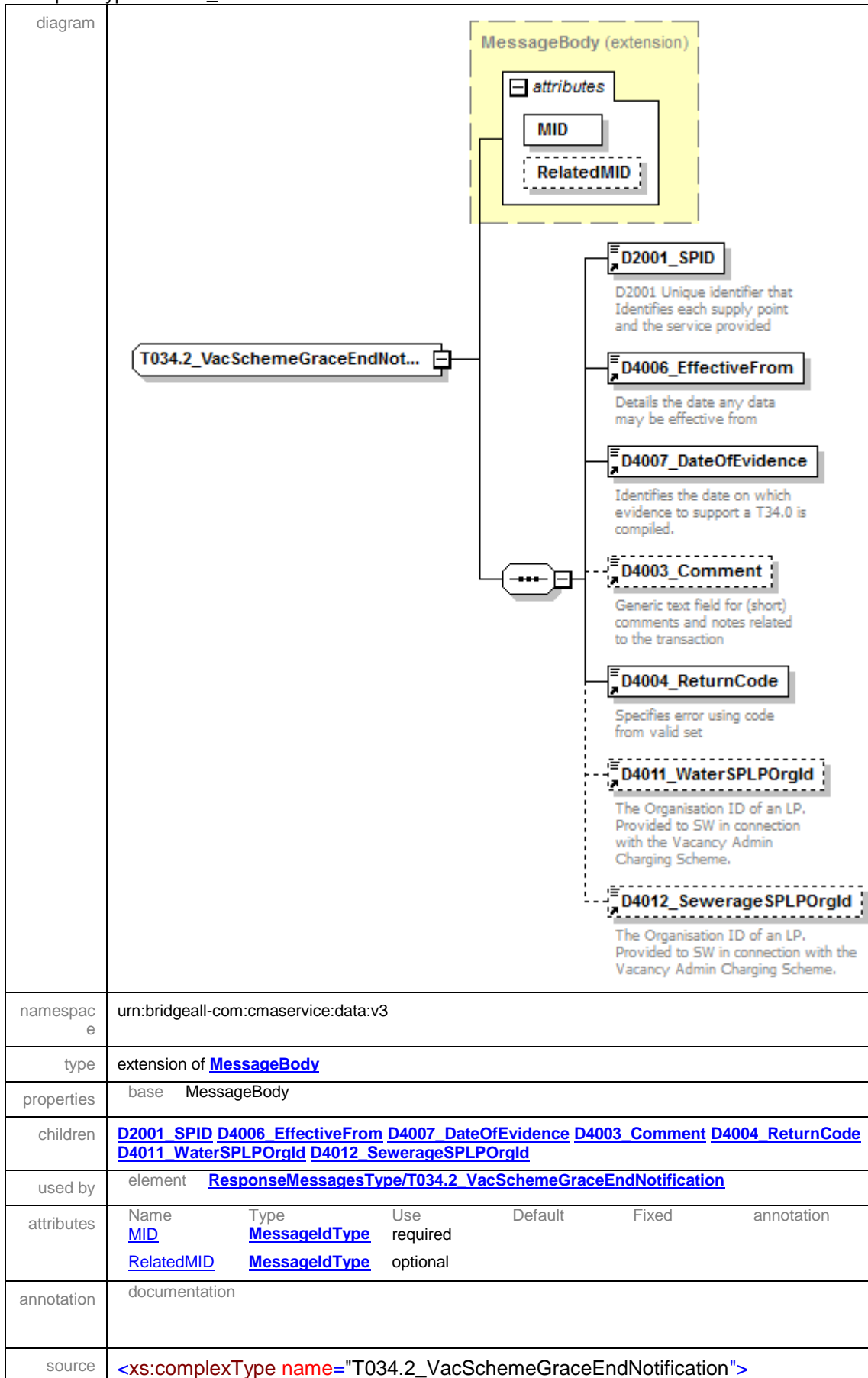

```
<xs:annotation>
  <xs:documentation>
    </xs:documentation>
  </xs:annotation>
<xs:complexContent>
  <xs:extension base="MessageBody">
    <xs:sequence>
      <xs:element ref="D2001_SPID"/>
      <xs:element ref="D4006_EffectiveFrom"/>
      <xs:element ref="D4007_DateOfEvidence"/>
      <xs:element ref="D4003_Comment" minOccurs="0"/>
      <xs:element ref="D4004_ReturnCode"/>
      <xs:element ref="D4011_WaterSPLPOrgId" minOccurs="0"/>
      <xs:element ref="D4012_SewerageSPLPOrgId" minOccurs="0"/>
    </xs:sequence>
  </xs:extension>
</xs:complexContent>
</xs:complexType>
```

complexType **T034.3_VacSchemeApplicationNotification**

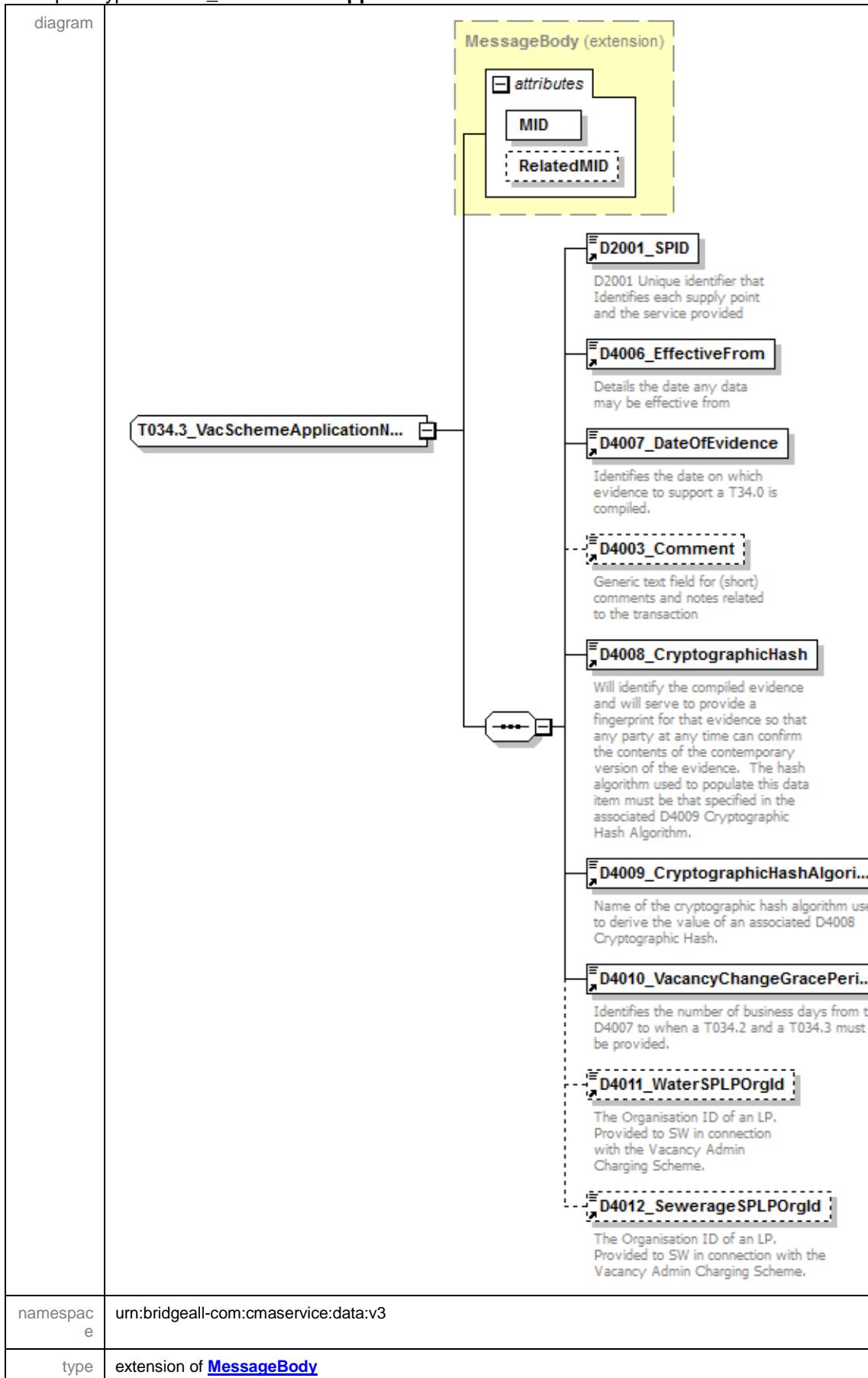

properties	base MessageBody					
children	D2001_SPID D4006_EffectiveFrom D4007_DateOfEvidence D4003_Comment D4008_CryptographicHash D4009_CryptographicHashAlgorithm D4010_VacancyChangeGracePeriod D4011_WaterSPLPOrgld D4012_SewerageSPLPOrgld					
used by	element ResponseMessagesType/T034.3_VacSchemeApplicationNotification					
attributes	Name	Type	Use	Default	Fixed	annotation
	MID	MessageIdType	required			
	RelatedMID	MessageIdType	optional			
annotation	documentation					
source	<pre> <xs:complexType name="T034.3_VacSchemeApplicationNotification"> <xs:annotation> <xs:documentation> </xs:documentation> </xs:annotation> <xs:complexContent> <xs:extension base="MessageBody"> <xs:sequence> <xs:element ref="D2001_SPID"/> <xs:element ref="D4006_EffectiveFrom"/> <xs:element ref="D4007_DateOfEvidence"/> <xs:element ref="D4003_Comment" minOccurs="0"/> <xs:element ref="D4008_CryptographicHash"/> <xs:element ref="D4009_CryptographicHashAlgorithm"/> <xs:element ref="D4010_VacancyChangeGracePeriod"/> <xs:element ref="D4011_WaterSPLPOrgld" minOccurs="0"/> <xs:element ref="D4012_SewerageSPLPOrgld" minOccurs="0"/> </xs:sequence> </xs:extension> </xs:complexContent> </xs:complexType> </pre>					

complexType **T034.4_VacSchemeApplicationConfirmationOrCancellation**

diagram						
namespace	urn:bridgeall-com:cmaservice:data:v3					
type	extension of MessageBody					
properties	base MessageBody					
children	D2001_SPID D4006_EffectiveFrom D4007_DateOfEvidence D2031_VacancyChangeFlag D2032_LPChallengedVacancyApplicationFlag D4003_Comment					
used by	MessagesType/T034.4_VacSchemeApplicationConfirmationOrCancellations/T034.4_VacSchemeApplicationConfirmationOrCancellation					
attributes	Name	Type	Use	Default	Fixed	annotation
	MID	MessageIdType	required			
	RelatedMID	MessageIdType	optional			
annotation	documentation					

source	<pre><xs:complexType name="T034.4_VacSchemeApplicationConfirmationOrCancellation"> <xs:annotation> <xs:documentation> </xs:documentation> </xs:annotation> <xs:complexContent> <xs:extension base="MessageBody"> <xs:sequence> <xs:element ref="D2001_SPID"/> <xs:element ref="D4006_EffectiveFrom"/> <xs:element ref="D4007_DateOfEvidence"/> <xs:element ref="D2031_VacancyChangeFlag"/> <xs:element ref="D2032_LPChallengedVacancyApplicationFlag"/> <xs:element ref="D4003_Comment" minOccurs="0"/> </xs:sequence> </xs:extension> </xs:complexContent> </xs:complexType></pre>
--------	---

complexType **T034.5_VacSchemeApplicationConfirmationOrCancellationNotification**

<p>diagram</p>	<p>The diagram illustrates the structure of the complex type T034.5_VacSchemeApplicationConfirmationOrCancellationNotification. It is an extension of MessageBody. The MessageBody (extension) contains an attributes container with two elements: MID (required) and RelatedMID (optional). The main type contains several data elements: D2001_SPID (required), D4006_EffectiveFrom (required), D4007_DateOfEvidence (required), D2031_VacancyChangeFlag (required), D2032_LPChallengedVacancyApplicationFlag (required), and D4003_Comment (optional).</p>																		
<p>namespace</p>	<p>urn:bridgeall-com:cmaservice:data:v3</p>																		
<p>type</p>	<p>extension of MessageBody</p>																		
<p>properties</p>	<p>base MessageBody</p>																		
<p>children</p>	<p>D2001_SPID D4006_EffectiveFrom D4007_DateOfEvidence D2031_VacancyChangeFlag D2032_LPChallengedVacancyApplicationFlag D4003_Comment</p>																		
<p>used by</p>	<p>element ResponseMessagesType/T034.5_VacSchemeApplicationConfirmationOrCancellationNotification</p>																		
<p>attributes</p>	<table border="1"> <thead> <tr> <th>Name</th> <th>Type</th> <th>Use</th> <th>Default</th> <th>Fixed</th> <th>annotation</th> </tr> </thead> <tbody> <tr> <td>MID</td> <td>MessageIdType</td> <td>required</td> <td></td> <td></td> <td></td> </tr> <tr> <td>RelatedMID</td> <td>MessageIdType</td> <td>optional</td> <td></td> <td></td> <td></td> </tr> </tbody> </table>	Name	Type	Use	Default	Fixed	annotation	MID	MessageIdType	required				RelatedMID	MessageIdType	optional			
Name	Type	Use	Default	Fixed	annotation														
MID	MessageIdType	required																	
RelatedMID	MessageIdType	optional																	
<p>annotation</p>	<p>documentation</p>																		
<p>source</p>	<p><xs:complexType name="T034.5_VacSchemeApplicationConfirmationOrCancellationNotification"></p>																		

```

<xs:annotation>
  <xs:documentation>
    </xs:documentation>
  </xs:annotation>
<xs:complexContent>
  <xs:extension base="MessageBody">
    <xs:sequence>
      <xs:element ref="D2001_SPID"/>
      <xs:element ref="D4006_EffectiveFrom"/>
      <xs:element ref="D4007_DateOfEvidence"/>
      <xs:element ref="D2031_VacancyChangeFlag"/>
      <xs:element ref="D2032_LPChallengedVacancyApplicationFlag"/>
      <xs:element ref="D4003_Comment" minOccurs="0"/>
    </xs:sequence>
  </xs:extension>
</xs:complexContent>
</xs:complexType>

```

complexType T035.0_TradeabilityNotification

diagram						
namespace	urn:bridgeall-com:cmaservice:data:v3					
type	extension of MessageBody					
properties	base MessageBody					
children	D2001_SPID D2013_ConnectionDate					
used by	element ResponseMessagesType/T035.0_TradeabilityNotification					
attributes	Name	Type	Use	Default	Fixed	annotation
	MID	MessageIdType	required			
	RelatedMID	MessageIdType	optional			
annotation	documentation					
source	<pre> <xs:complexType name="T035.0_TradeabilityNotification"> <xs:annotation> <xs:documentation> </xs:documentation> </xs:annotation> <xs:complexContent> </pre>					

```

<xs:extension base="MessageBody">
  <xs:sequence>
    <xs:element ref="D2001_SPID"/>
    <xs:element ref="D2013_ConnectionDate"/>
  </xs:sequence>
</xs:extension>
</xs:complexContent>
</xs:complexType>

```

complexType T035.1_TradeabilityNotification

diagram						
namespace	urn:bridgeall-com:cmaservice:data:v3					
type	extension of MessageBody					
properties	base MessageBody					
children	D2001_SPID D2013_ConnectionDate					
used by	element ResponseMessagesType/T035.1_TradeabilityNotification					
attributes	Name	Type	Use	Default	Fixed	annotation
	MID	MessageIdType	required			
	RelatedMID	MessageIdType	optional			
annotation	documentation					
source	<pre> <xs:complexType name="T035.1_TradeabilityNotification"> <xs:annotation> <xs:documentation> </xs:documentation> </xs:annotation> <xs:complexContent> <xs:extension base="MessageBody"> <xs:sequence> <xs:element ref="D2001_SPID"/> <xs:element ref="D2013_ConnectionDate"/> </xs:sequence> </xs:extension> </xs:complexContent> </xs:complexType> </pre>					

complexType TEUpdateType

diagram	<p>The diagram shows the structure of the TEUpdateType complex type. It is an extension of the MessageBody type. The MessageBody extension contains an attributes container with MID and RelatedMID. The TEUpdateType type contains the following elements:</p> <ul style="list-style-type: none"> D2001_SPID: D2001 Unique identifier that Identifies each supply point and the service provided (required). D6001_DPID: Discharge Point ID (required). D4006_EffectiveFrom: Details the date any data may be effective from (required). D6006_Ot: TE Operating Data: Fixed Strength Chemical Oxygen Demand (optional, minOccurs="0"). D6007_St: TE Operating Data: Fixed Strength Solids Demand (optional, minOccurs="0"). 																		
namespace	urn:bridgeall-com:cmaservice:data:v3																		
type	extension of MessageBody																		
properties	base MessageBody																		
children	D2001_SPID D6001_DPID D4006_EffectiveFrom D6006_Ot D6007_St																		
used by	elements MessagesType/T022.0_TEUpdates/T022.0_TEUpdateResponseMessagesType/T022.1_TEUpdateNotification																		
attributes	<table border="1"> <thead> <tr> <th>Name</th> <th>Type</th> <th>Use</th> <th>Default</th> <th>Fixed</th> <th>annotation</th> </tr> </thead> <tbody> <tr> <td>MID</td> <td>MessageIdType</td> <td>required</td> <td></td> <td></td> <td></td> </tr> <tr> <td>RelatedMID</td> <td>MessageIdType</td> <td>optional</td> <td></td> <td></td> <td></td> </tr> </tbody> </table>	Name	Type	Use	Default	Fixed	annotation	MID	MessageIdType	required				RelatedMID	MessageIdType	optional			
Name	Type	Use	Default	Fixed	annotation														
MID	MessageIdType	required																	
RelatedMID	MessageIdType	optional																	
annotation	documentation																		
source	<pre> <xs:complexType name="TEUpdateType"> <xs:annotation> <xs:documentation> </xs:documentation> </xs:annotation> <xs:complexContent> <xs:extension base="MessageBody"> <xs:sequence> <xs:element ref="D2001_SPID"/> <xs:element ref="D6001_DPID"/> <xs:element ref="D4006_EffectiveFrom"/> <xs:element ref="D6006_Ot" minOccurs="0"/> <xs:element ref="D6007_St" minOccurs="0"/> </xs:sequence> </xs:extension> </xs:complexContent> </xs:complexType> </pre>																		

	<pre> </xs:sequence> </xs:extension> </xs:complexContent> </xs:complexType> </pre>
--	--

complexType TransactionHeaderType

diagram	
namespace	urn:bridgeall-com:cmaservice:data:v3
children	D1005_SenderOrgId D1006_RecipientOrgId D1007_TransactionTimestamp D1003_FlowReference
used by	elements Submission/Header Response/ResponseHeader
source	<pre> <xs:complexType name="TransactionHeaderType"> <xs:sequence> <xs:element ref="D1005_SenderOrgId"/> <xs:element ref="D1006_RecipientOrgId"/> <xs:element ref="D1007_TransactionTimestamp"/> <xs:element ref="D1003_FlowReference" minOccurs="0"/> </xs:sequence> </xs:complexType> </pre>

complexType UARNTType

diagram	
namespace	urn:bridgeall-com:cmaservice:data:v3
children	D2037_SAARefereceNumber D2038_SAARefereceNumberAb...
used by	elements NewSPIDRequestType/UARNDData NewSPIDNotificationType/UARNDData NewLPSPIDNotificationType/UARNDData UpdateSAARefereceNumberUPRNTtype/UARNDData UpdateSAARefereceNumberUPRNNotificationType/UARNDData WaterSPIDDataTpe/UARNDData SewerageSPIDDataTpe/UARNDData
source	<pre> <xs:complexType name="UARNTType"> <xs:sequence> <xs:element name="D2037_SAARefereceNumber" minOccurs="0"> <xs:simpleType> <xs:restriction base="xs:string"> <xs:maxLength value="80"/> </xs:restriction> </xs:simpleType> </xs:element> </xs:sequence> </xs:complexType> </pre>

	<pre> <xs:whiteSpace value="preserve"/> <xs:pattern value="([A-Z][0-9][!#\$%'\(\)*\+, \-\.\/:;=\?][&#34;][&#62;])*"/> </xs:restriction> </xs:simpleType> </xs:element> <xs:element name="D2038_SAARefereceNumberAbsenceCode" type="UARNAbsenceCodeType" minOccurs="0"/> </xs:sequence> </xs:complexType> </pre>
--	---

element **UARNTType/D2037_SAARefereceNumber**

diagram													
namespace	urn:bridgeall-com:cmaservice:data:v3												
type	restriction of xs:string												
properties	<table> <tr><td>isRef</td><td>0</td></tr> <tr><td>minOcc</td><td>0</td></tr> <tr><td>maxOcc</td><td>1</td></tr> <tr><td>content</td><td>simple</td></tr> </table>	isRef	0	minOcc	0	maxOcc	1	content	simple				
isRef	0												
minOcc	0												
maxOcc	1												
content	simple												
facets	<table> <tr><td>Kind</td><td>Value</td><td>annotation</td></tr> <tr><td>maxLength</td><td>80</td><td></td></tr> <tr><td>whiteSpace</td><td>preserve</td><td></td></tr> <tr><td>pattern</td><td colspan="2">([A-Z][0-9][!#\$%'\(\)*\+, \-\.\/:;=\?][&#34;][&#62;])*</td></tr> </table>	Kind	Value	annotation	maxLength	80		whiteSpace	preserve		pattern	([A-Z][0-9][!#\$%'\(\)*\+, \-\.\/:;=\?]["][>])*	
Kind	Value	annotation											
maxLength	80												
whiteSpace	preserve												
pattern	([A-Z][0-9][!#\$%'\(\)*\+, \-\.\/:;=\?]["][>])*												
source	<pre> <xs:element name="D2037_SAARefereceNumber" minOccurs="0"> <xs:simpleType> <xs:restriction base="xs:string"> <xs:maxLength value="80"/> <xs:whiteSpace value="preserve"/> <xs:pattern value="([A-Z][0-9][!#\$%'\(\)*\+, \-\.\/:;=\?][&#34;][&#62;])*"/> </xs:restriction> </xs:simpleType> </xs:element> </pre>												

element **UARNTType/D2038_SAARefereceNumberAbsenceCode**

diagram																												
namespace	urn:bridgeall-com:cmaservice:data:v3																											
type	UARNAbsenceCodeType																											
properties	<table> <tr><td>isRef</td><td>0</td></tr> <tr><td>minOcc</td><td>0</td></tr> <tr><td>maxOcc</td><td>1</td></tr> <tr><td>content</td><td>simple</td></tr> </table>	isRef	0	minOcc	0	maxOcc	1	content	simple																			
isRef	0																											
minOcc	0																											
maxOcc	1																											
content	simple																											
facets	<table> <tr><td>Kind</td><td>Value</td><td>annotation</td></tr> <tr><td>enumeration</td><td>ME</td><td></td></tr> <tr><td>enumeration</td><td>AG</td><td></td></tr> <tr><td>enumeration</td><td>SR</td><td></td></tr> <tr><td>enumeration</td><td>RC</td><td></td></tr> <tr><td>enumeration</td><td>MT</td><td></td></tr> <tr><td>enumeration</td><td>CU</td><td></td></tr> <tr><td>enumeration</td><td>IP</td><td></td></tr> <tr><td>enumeration</td><td>BW</td><td></td></tr> </table>	Kind	Value	annotation	enumeration	ME		enumeration	AG		enumeration	SR		enumeration	RC		enumeration	MT		enumeration	CU		enumeration	IP		enumeration	BW	
Kind	Value	annotation																										
enumeration	ME																											
enumeration	AG																											
enumeration	SR																											
enumeration	RC																											
enumeration	MT																											
enumeration	CU																											
enumeration	IP																											
enumeration	BW																											

	enumeration OT enumeration NR enumeration CP
source	<pre><xs:element name="D2038_SAAReferenceNumberAbsenceCode" type="UARNAbsenceCodeType" minOccurs="0"/></pre>

complexType UpdateMeterLocationNotificationType

diagram																			
namespace	urn:bridgeall-com:cmaservice:data:v3																		
type	extension of MessageBody																		
properties	base MessageBody																		
children	D2001_SPID D3001_MeterId D3019_GISZFreeDescriptor D3025_MeterLocationCode																		
used by	element ResponseMessagesType/T013.3_UpdateMeterLocationNotification																		
attributes	<table border="1"> <thead> <tr> <th>Name</th> <th>Type</th> <th>Use</th> <th>Default</th> <th>Fixed</th> <th>annotation</th> </tr> </thead> <tbody> <tr> <td>MID</td> <td>MessageIdType</td> <td>required</td> <td></td> <td></td> <td></td> </tr> <tr> <td>RelatedMID</td> <td>MessageIdType</td> <td>optional</td> <td></td> <td></td> <td></td> </tr> </tbody> </table>	Name	Type	Use	Default	Fixed	annotation	MID	MessageIdType	required				RelatedMID	MessageIdType	optional			
Name	Type	Use	Default	Fixed	annotation														
MID	MessageIdType	required																	
RelatedMID	MessageIdType	optional																	
annotation	documentation																		
source	<pre><xs:complexType name="UpdateMeterLocationNotificationType"> <xs:annotation> <xs:documentation> </xs:documentation> </xs:annotation> <xs:complexContent> <xs:extension base="MessageBody"> <xs:sequence> <xs:element ref="D2001_SPID" minOccurs="0"/> </xs:sequence> </xs:extension> </xs:complexContent> </xs:complexType></pre>																		

	<pre> <xs:element ref="D3001_MeterId"/> <xs:element ref="D3019_GISZFreeDescriptor" minOccurs="0"/> <xs:element ref="D3025_MeterLocationCode" minOccurs="0"/> </xs:sequence> </xs:extension> </xs:complexContent> </xs:complexType> </pre>
--	---

complexType **UpdateMeterLocationType**

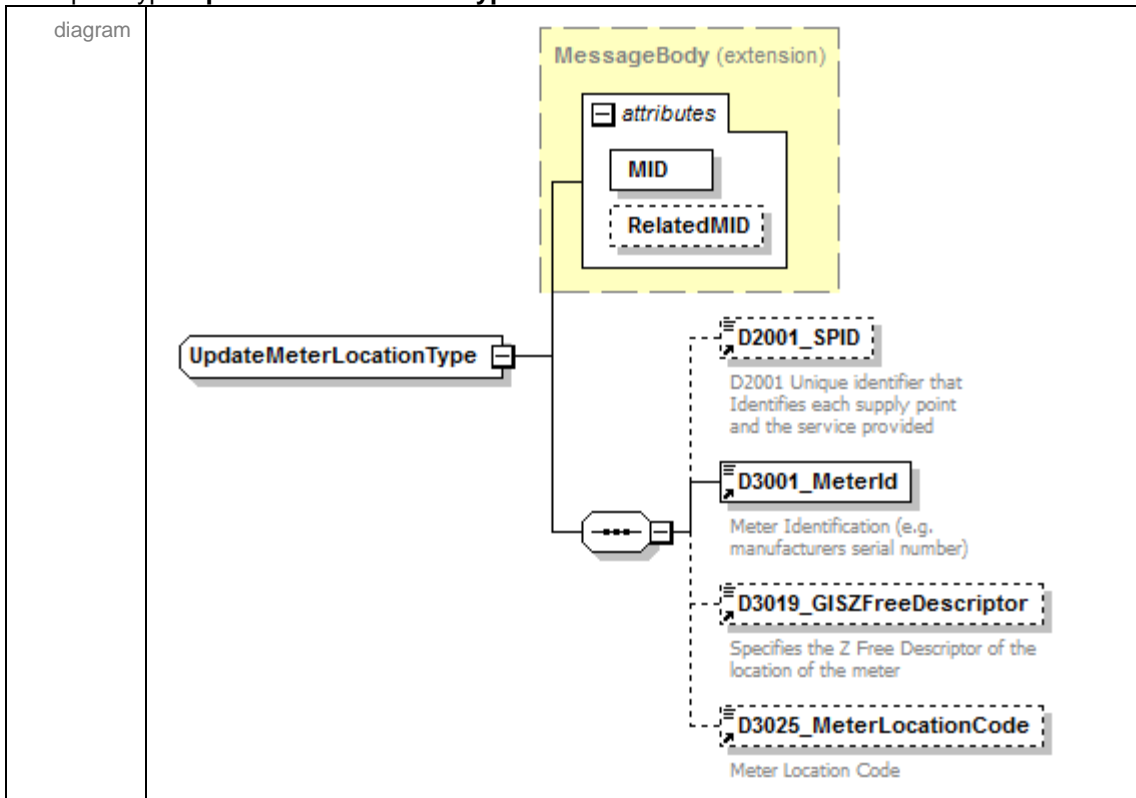

namespace	urn:bridgeall-com:cmaservice:data:v3					
type	extension of MessageBody					
properties	base MessageBody					
children	D2001_SPID D3001_MeterId D3019_GISZFreeDescriptor D3025_MeterLocationCode					
used by	element MessagesType/T013.2 UpdateMeterLocations/T013.2 UpdateMeterLocation					
attributes	Name	Type	Use	Default	Fixed	annotation
	MID	MessageIdType	required			
	RelatedMID	MessageIdType	optional			
annotation	documentation					

source	<pre> <xs:complexType name="UpdateMeterLocationType"> <xs:annotation> <xs:documentation> </xs:documentation> </xs:annotation> <xs:complexContent> <xs:extension base="MessageBody"> <xs:sequence> <xs:element ref="D2001_SPID" minOccurs="0"/> </pre>
--------	---

```

<xs:element ref="D3001_MeterId"/>
<xs:element ref="D3019_GISZFreeDescriptor" minOccurs="0"/>
<xs:element ref="D3025_MeterLocationCode" minOccurs="0"/>
</xs:sequence>
</xs:extension>
</xs:complexContent>
</xs:complexType>

```

complexType **UpdateSAARefereceNumberUPRNNotificationType**

diagram						
namespace	urn:bridgeall-com:cmaservice:data:v3					
type	extension of MessageBody					
properties	base MessageBody					
children	D2001_SPID UARNDData UPRNDData					
used by	element ResponseMessagesType/T012.6_UpdateSAARefereceNumberUPRNNotification					
attributes	Name	Type	Use	Default	Fixed	annotation
	MID	MessageIdType	required			
	RelatedMID	MessageIdType	optional			
annotation	documentation					
source	<pre> <xs:complexType name="UpdateSAARefereceNumberUPRNNotificationType"> <xs:annotation> <xs:documentation> </xs:documentation> </xs:annotation> <xs:complexContent> <xs:extension base="MessageBody"> <xs:sequence> <xs:element ref="D2001_SPID"/> <xs:element name="UARNDData" type="UARNTYPE" minOccurs="0"/> <xs:element name="UPRNDData" type="UPRNTYPE" minOccurs="0"/> </xs:sequence> </xs:extension> </xs:complexContent> </xs:complexType> </pre>					

element **UpdateSAAResponseNumberUPRNNotificationType/UARNDData**

diagram	<p>The diagram illustrates the structure of the UARNDData element. It is represented as a dashed box on the left, connected by a line to a central octagonal connector. This connector is linked to a larger dashed box on the right labeled 'UARNTYPE'. Inside the 'UARNTYPE' box, there are two smaller dashed boxes representing child elements: 'D2037_SAAResponseNumber' and 'D2038_SAAResponseNumberAbsenceCode'.</p>
namespace	urn:bridgeall-com:cmaservice:data:v3
type	UARNTYPE
properties	isRef 0 minOcc 0 maxOcc 1 content complex
children	D2037 SAAResponseNumber D2038 SAAResponseNumberAbsenceCode
source	<code><xs:element name="UARNDData" type="UARNTYPE" minOccurs="0"/></code>

element **UpdateSAAResponseNumberUPRNNotificationType/UPRNDData**

diagram	<p>The diagram illustrates the structure of the UPRNDData element. It is represented as a dashed box on the left, connected by a line to a central octagonal connector. This connector is linked to a larger dashed box on the right labeled 'UPRNTYPE'. Inside the 'UPRNTYPE' box, there are two smaller dashed boxes representing child elements: 'D2039_UPRN' and 'D2040_UPRNAbsenceCode'.</p>
namespace	urn:bridgeall-com:cmaservice:data:v3
type	UPRNTYPE
properties	isRef 0 minOcc 0 maxOcc 1 content complex
children	D2039 UPRN D2040 UPRNAbsenceCode
source	<code><xs:element name="UPRNDData" type="UPRNTYPE" minOccurs="0"/></code>

complexType UpdateSAARefereceNumberUPRNTYPE

diagram						
namespace	urn:bridgeall-com:cmaservice:data:v3					
type	extension of MessageBody					
properties	base MessageBody					
children	D2001_SPID UARNDData UPRNDData					
used by	element MessagesType/T012.5 UpdateSAARefereceNumberUPRNs/T012.5 UpdateSAARefereceNumberUPRN					
attributes	Name	Type	Use	Default	Fixed	annotation
	MID	MessageIdType	required			
	RelatedMID	MessageIdType	optional			
annotation	documentation					
source	<pre> <xs:complexType name="UpdateSAARefereceNumberUPRNTYPE"> <xs:annotation> <xs:documentation> </xs:documentation> </xs:annotation> <xs:complexContent> <xs:extension base="MessageBody"> <xs:sequence> <xs:element ref="D2001_SPID"/> <xs:element name="UARNDData" type="UARNTYPE" minOccurs="0"/> <xs:element name="UPRNDData" type="UPRNTYPE" minOccurs="0"/> </xs:sequence> </xs:extension> </xs:complexContent> </xs:complexType> </pre>					

element **UpdateSAAReferenceNumberUPRNTYPE/UARNDData**

diagram	
namespace	urn:bridgeall-com:cmaservice:data:v3
type	UARNTYPE
properties	isRef 0 minOcc 0 maxOcc 1 content complex
children	D2037_SAAReferenceNumber D2038_SAAReferenceNumberAbsenceCode
source	<code><xs:element name="UARNDData" type="UARNTYPE" minOccurs="0"/></code>

element **UpdateSAAReferenceNumberUPRNTYPE/UPRNDData**

diagram	
namespace	urn:bridgeall-com:cmaservice:data:v3
type	UPRNTYPE
properties	isRef 0 minOcc 0 maxOcc 1 content complex
children	D2039_UPRN D2040_UPRNAbseceCode
source	<code><xs:element name="UPRNDData" type="UPRNTYPE" minOccurs="0"/></code>

complexType **UPRNTYPE**

diagram	
namespace	urn:bridgeall-com:cmaservice:data:v3
children	D2039_UPRN D2040_UPRNAbseceCode
used by	elements NewSPIDRequestType/UPRNDData NewSPIDNotificationType/UPRNDData NewLPSPIDNotificationType/UPRNDData UpdateSAAReferenceNumberUPRNTYPE/UPRNDData UpdateSAAReferenceNumberUPRNNotificationType/UPRNDData WaterSPIDDataType/UPRNDData SewerageSPIDDataType/UPRNDData
source	<code><xs:complexType name="UPRNTYPE"> <xs:sequence> <xs:element name="D2039_UPRN" minOccurs="0"> <xs:simpleType></code>

	<pre> <xs:restriction base="xs:decimal"> <xs:totalDigits value="12"/> <xs:fractionDigits value="0"/> <xs:minInclusive value="0"/> <xs:maxInclusive value="999999999999"/> </xs:restriction> </xs:simpleType> </xs:element> <xs:element name="D2040_UPRNAbsenceCode" type="UPRNAbsenceCodeType" minOccurs="0"/> </xs:sequence> </xs:complexType> </pre>
--	--

element UPRNType/D2039_UPRN

diagram																
namespace	urn:bridgeall-com:cmaservice:data:v3															
type	restriction of xs:decimal															
properties	<table border="0"> <tr><td>isRef</td><td>0</td></tr> <tr><td>minOcc</td><td>0</td></tr> <tr><td>maxOcc</td><td>1</td></tr> <tr><td>content</td><td>simple</td></tr> </table>	isRef	0	minOcc	0	maxOcc	1	content	simple							
isRef	0															
minOcc	0															
maxOcc	1															
content	simple															
facets	<table border="0"> <tr><td>Kind</td><td>Value</td><td>annotation</td></tr> <tr><td>minInclusive</td><td>0</td><td></td></tr> <tr><td>maxInclusive</td><td>999999999999</td><td></td></tr> <tr><td>totalDigits</td><td>12</td><td></td></tr> <tr><td>fractionDigits</td><td>0</td><td></td></tr> </table>	Kind	Value	annotation	minInclusive	0		maxInclusive	999999999999		totalDigits	12		fractionDigits	0	
Kind	Value	annotation														
minInclusive	0															
maxInclusive	999999999999															
totalDigits	12															
fractionDigits	0															
source	<pre> <xs:element name="D2039_UPRN" minOccurs="0"> <xs:simpleType> <xs:restriction base="xs:decimal"> <xs:totalDigits value="12"/> <xs:fractionDigits value="0"/> <xs:minInclusive value="0"/> <xs:maxInclusive value="999999999999"/> </xs:restriction> </xs:simpleType> </xs:element> </pre>															

element UPRNType/D2040_UPRNAbsenceCode

diagram																
namespace	urn:bridgeall-com:cmaservice:data:v3															
type	UPRNAbsenceCodeType															
properties	<table border="0"> <tr><td>isRef</td><td>0</td></tr> <tr><td>minOcc</td><td>0</td></tr> <tr><td>maxOcc</td><td>1</td></tr> <tr><td>content</td><td>simple</td></tr> </table>	isRef	0	minOcc	0	maxOcc	1	content	simple							
isRef	0															
minOcc	0															
maxOcc	1															
content	simple															
facets	<table border="0"> <tr><td>Kind</td><td>Value</td><td>annotation</td></tr> <tr><td>enumeration</td><td>ME</td><td></td></tr> <tr><td>enumeration</td><td>AG</td><td></td></tr> <tr><td>enumeration</td><td>SR</td><td></td></tr> <tr><td>enumeration</td><td>RC</td><td></td></tr> </table>	Kind	Value	annotation	enumeration	ME		enumeration	AG		enumeration	SR		enumeration	RC	
Kind	Value	annotation														
enumeration	ME															
enumeration	AG															
enumeration	SR															
enumeration	RC															

	enumeration MT enumeration CU enumeration IP enumeration BW enumeration OT enumeration PL
source	<xs:element name="D2040_UPRNAbsenceCode" type="UPRNAbsenceCodeType" minOccurs="0"/>

complexType **WaterSPIDDataType**

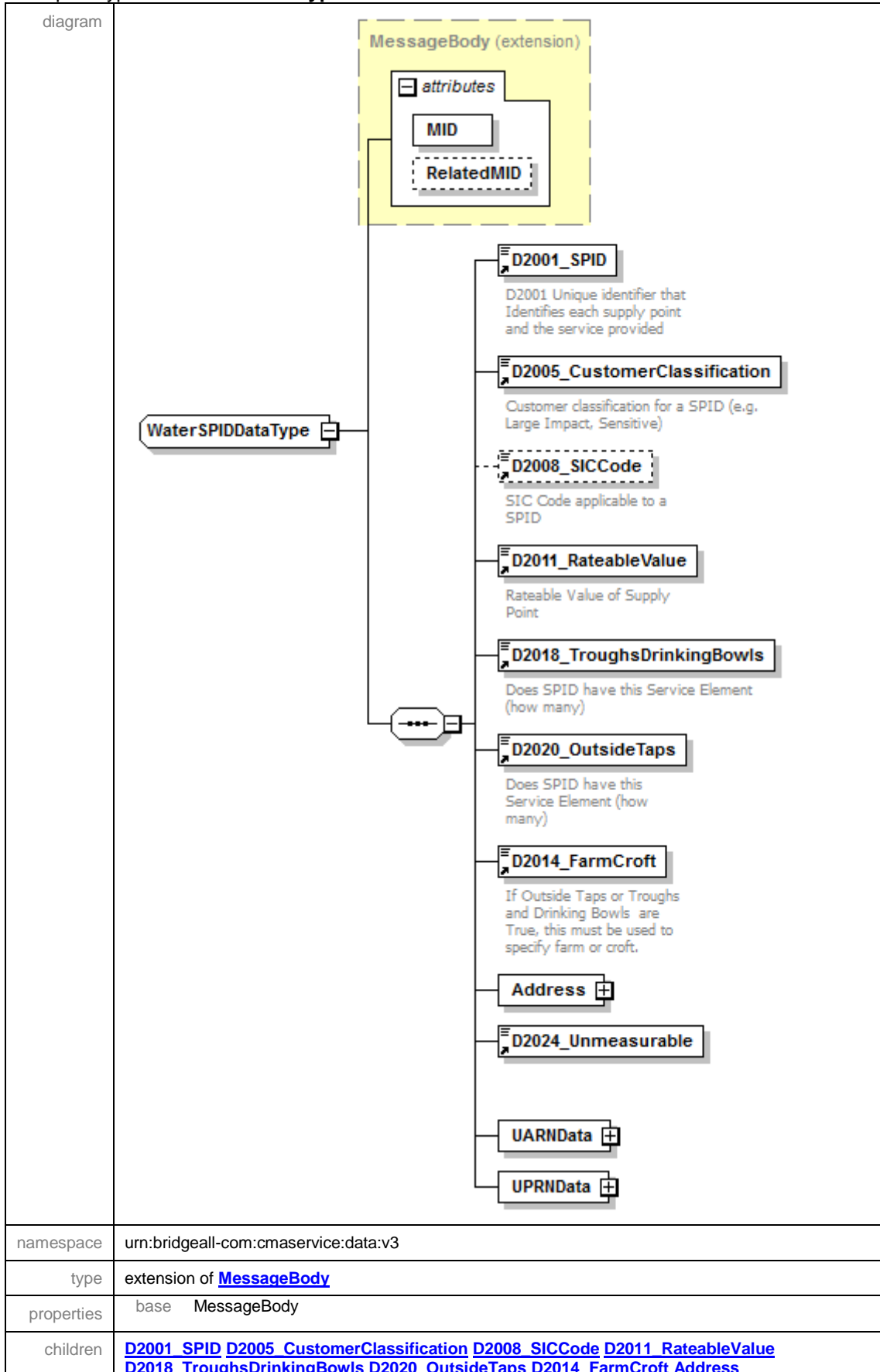

	D2024_Unmeasurable_UARNData_UPRNData					
used by	element ResponseMessagesType/T019.0_WaterSPIDData					
attributes	Name	Type	Use	Default	Fixed	annotation
	MID	MessageIdType	required			
	RelatedMID	MessageIdType	optional			
annotation	documentation					
source	<pre> <xs:complexType name="WaterSPIDDataType"> <xs:annotation> <xs:documentation> </xs:documentation> </xs:annotation> <xs:complexContent> <xs:extension base="MessageBody"> <xs:sequence> <xs:element ref="D2001_SPID"/> <xs:element ref="D2005_CustomerClassification"/> <xs:element ref="D2008_SICCode" minOccurs="0"/> <xs:element ref="D2011_RateableValue"/> <xs:element ref="D2018_TroughsDrinkingBowls"/> <xs:element ref="D2020_OutsideTaps"/> <xs:element ref="D2014_FarmCroft"/> <xs:element name="Address" type="AddressType"/> <xs:element ref="D2024_Unmeasurable"/> <xs:element name="UARNData" type="UARNType"/> <xs:element name="UPRNData" type="UPRNType"/> </xs:sequence> </xs:extension> </xs:complexContent> </xs:complexType> </pre>					

element **WaterSPIDData/Address**

<p>diagram</p>	
<p>namespace</p>	<p>urn:bridgeall-com:cmaservice:data:v3</p>
<p>type</p>	<p>AddressType</p>
<p>properties</p>	<p>isRef 0 content complex</p>
<p>children</p>	<p>D5001_FreeDescriptor D5002_SubBuildingName D5003_BuildingName D5004_BuildingNumber D5005_DependentThoroughfareName D5006_DependentThoroughfareDescriptor D5007_ThoroughfareName D5008_ThoroughfareDescriptor D5009_DoubleDependentLocality D5010_DependentLocality D5011_PostTown D5012_County D5013_Postcode</p>
<p>source</p>	<p><xs:element name="Address" type="AddressType"/></p>

element **WaterSPIDData/UARNData**

<p>diagram</p>	
<p>namespace</p>	<p>urn:bridgeall-com:cmaservice:data:v3</p>
<p>type</p>	<p>UARNTYPE</p>
<p>properties</p>	<p>isRef 0 content complex</p>

children	D2037 SAAResponseNumber D2038 SAAResponseNumberAbsenceCode
source	<code><xs:element name="UARNDData" type="UARNTType"/></code>

element **WaterSPIDData**/UPRNDData

diagram	<p>The diagram illustrates the structure of the UPRNDData element. It is a container element that contains a single child element named UPRNTType. The UPRNTType element is further detailed as containing two child elements: D2039_UPRN and D2040_UPRNBabsenceCode.</p>
namespace	urn:bridgeall-com:cmaservice:data:v3
type	UPRNTType
properties	isRef 0 content complex
children	D2039 UPRN D2040 UPRNBabsenceCode
source	<code><xs:element name="UPRNDData" type="UPRNTType"/></code>

simpleType **AllocationMethodType**

namespace	urn:bridgeall-com:cmaservice:data:v3												
type	restriction of xs:string												
properties	base xs:string												
used by	element D2034 AllocationMethod												
facets	<table border="0"> <thead> <tr> <th>Kind</th> <th>Value</th> <th>annotation</th> </tr> </thead> <tbody> <tr> <td>enumeration</td> <td>Associated SPID</td> <td></td> </tr> <tr> <td>enumeration</td> <td>Rotation</td> <td></td> </tr> <tr> <td>enumeration</td> <td>N/A</td> <td></td> </tr> </tbody> </table>	Kind	Value	annotation	enumeration	Associated SPID		enumeration	Rotation		enumeration	N/A	
Kind	Value	annotation											
enumeration	Associated SPID												
enumeration	Rotation												
enumeration	N/A												
annotation	<p>documentation</p> <table border="0"> <tbody> <tr> <td>Enumeration of AllocationMethodType</td> <td></td> </tr> <tr> <td>Associated SPID</td> <td>0</td> </tr> <tr> <td>Rotation</td> <td>1</td> </tr> <tr> <td>N/A</td> <td>2</td> </tr> </tbody> </table>	Enumeration of AllocationMethodType		Associated SPID	0	Rotation	1	N/A	2				
Enumeration of AllocationMethodType													
Associated SPID	0												
Rotation	1												
N/A	2												
source	<pre> <xs:simpleType name="AllocationMethodType"> <xs:annotation> <xs:documentation> Enumeration of AllocationMethodType Associated SPID 0 Rotation 1 N/A 2 </xs:documentation> </xs:annotation> <xs:restriction base="xs:string"> <xs:enumeration value="Associated SPID"/> <xs:enumeration value="Rotation"/> <xs:enumeration value="N/A"/> </xs:restriction> </xs:simpleType> </pre>												

simpleType CancellationCodeType

namespace	urn:bridgeall-com:cmaservice:data:v3																		
type	restriction of xs:string																		
properties	base xs:string																		
used by	element D4005 CancellationCode																		
facets	<table border="1"> <thead> <tr> <th>Kind</th> <th>Value</th> <th>annotation</th> </tr> </thead> <tbody> <tr> <td>enumeration</td> <td>S</td> <td></td> </tr> <tr> <td>enumeration</td> <td>N</td> <td></td> </tr> <tr> <td>enumeration</td> <td>D</td> <td></td> </tr> <tr> <td>enumeration</td> <td>C</td> <td></td> </tr> <tr> <td>enumeration</td> <td>F</td> <td></td> </tr> </tbody> </table>	Kind	Value	annotation	enumeration	S		enumeration	N		enumeration	D		enumeration	C		enumeration	F	
Kind	Value	annotation																	
enumeration	S																		
enumeration	N																		
enumeration	D																		
enumeration	C																		
enumeration	F																		
annotation	documentation S SPID error (incoming LP) N No contract (incoming LP) D Outstanding debt (outgoing LP) C Contract in term (outgoing LP) F Self Supplier (outgoing LP)																		
source	<pre> <xs:simpleType name="CancellationCodeType"> <xs:annotation> <xs:documentation> S SPID error (incoming LP) N No contract (incoming LP) D Outstanding debt (outgoing LP) C Contract in term (outgoing LP) F Self Supplier (outgoing LP) </xs:documentation> </xs:annotation> <xs:restriction base="xs:string"> <xs:enumeration value="S"/> <xs:enumeration value="N"/> <xs:enumeration value="D"/> <xs:enumeration value="C"/> <xs:enumeration value="F"/> </xs:restriction> </xs:simpleType> </pre>																		

simpleType CryptographicHashAlgorithm

namespace	urn:bridgeall-com:cmaservice:data:v3						
type	restriction of xs:string						
properties	base xs:string						
used by	element D4009 CryptographicHashAlgorithm						
facets	<table border="1"> <thead> <tr> <th>Kind</th> <th>Value</th> <th>annotation</th> </tr> </thead> <tbody> <tr> <td>enumeration</td> <td>SHA256</td> <td></td> </tr> </tbody> </table>	Kind	Value	annotation	enumeration	SHA256	
Kind	Value	annotation					
enumeration	SHA256						
annotation	documentation Enumeration of Cryptographic Hash Algorithms SHA256						
source	<pre> <xs:simpleType name="CryptographicHashAlgorithm"> <xs:annotation> <xs:documentation> </pre>						

	<p>Enumeration of Cryptographic Hash Algorithms SHA256</p> <pre> </xs:documentation> </xs:annotation> <xs:restriction base="xs:string"> <xs:enumeration value="SHA256"/> </xs:restriction> </xs:simpleType> </pre>
--	--

simpleType **CustomerClassificationType**

namespace	urn:bridgeall-com:cmaservice:data:v3												
type	restriction of xs:string												
properties	base xs:string												
used by	element D2005_CustomerClassification												
facets	<table border="0"> <tr> <td>Kind</td> <td>Value</td> <td>annotation</td> </tr> <tr> <td>enumeration</td> <td>LIC</td> <td></td> </tr> <tr> <td>enumeration</td> <td>SST</td> <td></td> </tr> <tr> <td>enumeration</td> <td>NA</td> <td></td> </tr> </table>	Kind	Value	annotation	enumeration	LIC		enumeration	SST		enumeration	NA	
Kind	Value	annotation											
enumeration	LIC												
enumeration	SST												
enumeration	NA												
annotation	<p>documentation</p> <p>Enumeration of Customer Classification types LIC Large Impact Customer SST Sensitive Customer NA Not Applicable</p>												
source	<pre> <xs:simpleType name="CustomerClassificationType"> <xs:annotation> <xs:documentation> Enumeration of Customer Classification types LIC Large Impact Customer SST Sensitive Customer NA Not Applicable </xs:documentation> </xs:annotation> <xs:restriction base="xs:string"> <xs:enumeration value="LIC"/> <xs:enumeration value="SST"/> <xs:enumeration value="NA"/> </xs:restriction> </xs:simpleType> </pre>												

simpleType **CustomerNameType**

namespace	urn:bridgeall-com:cmaservice:data:v3									
type	restriction of xs:string									
properties	base xs:string									
used by	element D2028_CustomerNameType									
facets	<table border="0"> <tr> <td>Kind</td> <td>Value</td> <td>annotation</td> </tr> <tr> <td>enumeration</td> <td>Customer</td> <td></td> </tr> <tr> <td>enumeration</td> <td>Developer</td> <td></td> </tr> </table>	Kind	Value	annotation	enumeration	Customer		enumeration	Developer	
Kind	Value	annotation								
enumeration	Customer									
enumeration	Developer									
annotation	<p>documentation</p> <p>Enumeration of Customer Name types Customer</p>									

	Developer
source	<pre> <xs:simpleType name="CustomerNameType"> <xs:annotation> <xs:documentation> Enumeration of Customer Name types Customer Developer </xs:documentation> </xs:annotation> <xs:restriction base="xs:string"> <xs:enumeration value="Customer"/> <xs:enumeration value="Developer"/> </xs:restriction> </xs:simpleType> </pre>

simpleType decimal18

namespace	urn:bridgeall-com:cmaservice:data:v3															
type	restriction of xs:decimal															
properties	base xs:decimal															
used by	elements D6002 TEYVe D6003 CDV D6004 sBODL D6005 TSSL D6006 Ot D6007 St															
facets	<table border="1"> <thead> <tr> <th>Kind</th> <th>Value</th> <th>annotation</th> </tr> </thead> <tbody> <tr> <td>minInclusive</td> <td>0</td> <td></td> </tr> <tr> <td>maxInclusive</td> <td>9999999999</td> <td></td> </tr> <tr> <td>totalDigits</td> <td>18</td> <td></td> </tr> <tr> <td>fractionDigits</td> <td>8</td> <td></td> </tr> </tbody> </table>	Kind	Value	annotation	minInclusive	0		maxInclusive	9999999999		totalDigits	18		fractionDigits	8	
Kind	Value	annotation														
minInclusive	0															
maxInclusive	9999999999															
totalDigits	18															
fractionDigits	8															
source	<pre> <xs:simpleType name="decimal18"> <xs:restriction base="xs:decimal"> <xs:totalDigits value="18"/> <xs:fractionDigits value="8"/> <xs:minInclusive value="0"/> <xs:maxInclusive value="9999999999"/> </xs:restriction> </xs:simpleType> </pre>															

simpleType DisconnectionReconnectionType

namespace	urn:bridgeall-com:cmaservice:data:v3															
type	restriction of xs:string															
properties	base xs:string															
used by	element D2025 DisconnectionReconnection															
facets	<table border="1"> <thead> <tr> <th>Kind</th> <th>Value</th> <th>annotation</th> </tr> </thead> <tbody> <tr> <td>enumeration</td> <td>REC</td> <td></td> </tr> <tr> <td>enumeration</td> <td>TDISC</td> <td></td> </tr> <tr> <td>enumeration</td> <td>PDISC</td> <td></td> </tr> <tr> <td>enumeration</td> <td>DEREG</td> <td></td> </tr> </tbody> </table>	Kind	Value	annotation	enumeration	REC		enumeration	TDISC		enumeration	PDISC		enumeration	DEREG	
Kind	Value	annotation														
enumeration	REC															
enumeration	TDISC															
enumeration	PDISC															
enumeration	DEREG															
annotation	<p>documentation</p> <p>Disconnection - Reconnection Type REC Reconnection TDISC Temporary Disconnection PDISC Permanent Disconnection</p>															

	DEREG Deregistration
source	<pre> <xs:simpleType name="DisconnectionReconnectionType"> <xs:annotation> <xs:documentation> Disconnection - Reconnection Type REC Reconnection TDISC Temporary Disconnection PDISC Permanent Disconnection DEREK Deregistration </xs:documentation> </xs:annotation> <xs:restriction base="xs:string"> <xs:enumeration value="REC"/> <xs:enumeration value="TDISC"/> <xs:enumeration value="PDISC"/> <xs:enumeration value="DEREG"/> </xs:restriction> </xs:simpleType> </pre>

simpleType FarmCroftType

namespace	urn:bridgeall-com:cmaservice:data:v3												
type	restriction of xs:string												
properties	base xs:string												
used by	element D2014 FarmCroft												
facets	<table border="1"> <thead> <tr> <th>Kind</th> <th>Value</th> <th>annotation</th> </tr> </thead> <tbody> <tr> <td>enumeration</td> <td>FARM</td> <td></td> </tr> <tr> <td>enumeration</td> <td>CROFT</td> <td></td> </tr> <tr> <td>enumeration</td> <td>NA</td> <td></td> </tr> </tbody> </table>	Kind	Value	annotation	enumeration	FARM		enumeration	CROFT		enumeration	NA	
Kind	Value	annotation											
enumeration	FARM												
enumeration	CROFT												
enumeration	NA												
annotation	<p>documentation</p> <table border="1"> <thead> <tr> <th>Enumeration of</th> <th>Farm</th> </tr> </thead> <tbody> <tr> <td>FARM</td> <td>Farm</td> </tr> <tr> <td>CROFT</td> <td>Croft or Small Holding</td> </tr> <tr> <td>NA</td> <td>Not applicable</td> </tr> </tbody> </table>	Enumeration of	Farm	FARM	Farm	CROFT	Croft or Small Holding	NA	Not applicable				
Enumeration of	Farm												
FARM	Farm												
CROFT	Croft or Small Holding												
NA	Not applicable												
source	<pre> <xs:simpleType name="FarmCroftType"> <xs:annotation> <xs:documentation> Enumeration of FARM Farm CROFT Croft or Small Holding NA Not applicable </xs:documentation> </xs:annotation> <xs:restriction base="xs:string"> <xs:enumeration value="FARM"/> <xs:enumeration value="CROFT"/> <xs:enumeration value="NA"/> </xs:restriction> </xs:simpleType> </pre>												

simpleType **MessageIdType**

namespace	urn:bridgeall-com:cmaservice:data:v3												
type	restriction of xs:string												
properties	base xs:string												
used by	attributes MessageBody/@MID MessageBody/@RelatedMID												
facets	<table border="1"> <thead> <tr> <th>Kind</th> <th>Value</th> <th>annotation</th> </tr> </thead> <tbody> <tr> <td>minLength</td> <td>16</td> <td></td> </tr> <tr> <td>maxLength</td> <td>16</td> <td></td> </tr> <tr> <td>pattern</td> <td>([a-z][A-Z][0-9])*</td> <td></td> </tr> </tbody> </table>	Kind	Value	annotation	minLength	16		maxLength	16		pattern	([a-z][A-Z][0-9])*	
Kind	Value	annotation											
minLength	16												
maxLength	16												
pattern	([a-z][A-Z][0-9])*												
source	<pre><xs:simpleType name="MessageIdType"> <xs:restriction base="xs:string"> <xs:maxLength value="16"/> <xs:minLength value="16"/> <xs:pattern value="([a-z][A-Z][0-9])*"/> </xs:restriction> </xs:simpleType></pre>												

simpleType **MeterLocationCodeType**

namespace	urn:bridgeall-com:cmaservice:data:v3															
type	restriction of xs:string															
properties	base xs:string															
used by	element D3025 MeterLocationCode															
facets	<table border="1"> <thead> <tr> <th>Kind</th> <th>Value</th> <th>annotation</th> </tr> </thead> <tbody> <tr> <td>enumeration</td> <td>M1</td> <td></td> </tr> <tr> <td>enumeration</td> <td>M2</td> <td></td> </tr> <tr> <td>enumeration</td> <td>M3</td> <td></td> </tr> <tr> <td>enumeration</td> <td>M4</td> <td></td> </tr> </tbody> </table>	Kind	Value	annotation	enumeration	M1		enumeration	M2		enumeration	M3		enumeration	M4	
Kind	Value	annotation														
enumeration	M1															
enumeration	M2															
enumeration	M3															
enumeration	M4															
annotation	<p>documentation</p> <table border="1"> <thead> <tr> <th>Meter Location Code</th> <th></th> <th></th> </tr> </thead> <tbody> <tr> <td>M1</td> <td>0</td> <td>Outside the property boundary</td> </tr> <tr> <td>M2</td> <td>1</td> <td>Just inside the property boundary</td> </tr> <tr> <td>M3</td> <td>2</td> <td>Further inside the property boundary</td> </tr> <tr> <td>M4</td> <td>3</td> <td>Inside the building</td> </tr> </tbody> </table>	Meter Location Code			M1	0	Outside the property boundary	M2	1	Just inside the property boundary	M3	2	Further inside the property boundary	M4	3	Inside the building
Meter Location Code																
M1	0	Outside the property boundary														
M2	1	Just inside the property boundary														
M3	2	Further inside the property boundary														
M4	3	Inside the building														
source	<pre><xs:simpleType name="MeterLocationCodeType"> <xs:annotation> <xs:documentation> Meter Location Code M1 0 Outside the property boundary M2 1 Just inside the property boundary M3 2 Further inside the property boundary M4 3 Inside the building </xs:documentation> </xs:annotation> <xs:restriction base="xs:string"> <xs:enumeration value="M1"/> <xs:enumeration value="M2"/> <xs:enumeration value="M3"/> <xs:enumeration value="M4"/> </xs:restriction> </xs:simpleType></pre>															

simpleType MeterTreatmentType

namespace	urn:bridgeall-com:cmaservice:data:v3																					
type	restriction of xs:string																					
properties	base xs:string																					
used by	element D3022 MeterTreatment																					
facets	<table border="1"> <thead> <tr> <th>Kind</th> <th>Value</th> <th>annotation</th> </tr> </thead> <tbody> <tr> <td>enumeration</td> <td>SWWater</td> <td></td> </tr> <tr> <td>enumeration</td> <td>PrivateWater</td> <td></td> </tr> <tr> <td>enumeration</td> <td>PrivateEffluent</td> <td></td> </tr> <tr> <td>enumeration</td> <td>TankeredEffluent</td> <td></td> </tr> <tr> <td>enumeration</td> <td>LogicalWater</td> <td></td> </tr> <tr> <td>enumeration</td> <td>PseudoWater</td> <td></td> </tr> </tbody> </table>	Kind	Value	annotation	enumeration	SWWater		enumeration	PrivateWater		enumeration	PrivateEffluent		enumeration	TankeredEffluent		enumeration	LogicalWater		enumeration	PseudoWater	
Kind	Value	annotation																				
enumeration	SWWater																					
enumeration	PrivateWater																					
enumeration	PrivateEffluent																					
enumeration	TankeredEffluent																					
enumeration	LogicalWater																					
enumeration	PseudoWater																					
annotation	<p>documentation</p> <table border="1"> <tbody> <tr> <td colspan="3">Enumeration of Meter Treatment indicator</td> </tr> <tr> <td>SWWater</td> <td></td> <td>0</td> </tr> <tr> <td>PrivateWater</td> <td>1</td> <td></td> </tr> <tr> <td>PrivateEffluent</td> <td>2</td> <td></td> </tr> <tr> <td>TankeredEffluent</td> <td>3</td> <td></td> </tr> <tr> <td>LogicalWater</td> <td>4</td> <td></td> </tr> <tr> <td>PseudoWater</td> <td>5</td> <td></td> </tr> </tbody> </table>	Enumeration of Meter Treatment indicator			SWWater		0	PrivateWater	1		PrivateEffluent	2		TankeredEffluent	3		LogicalWater	4		PseudoWater	5	
Enumeration of Meter Treatment indicator																						
SWWater		0																				
PrivateWater	1																					
PrivateEffluent	2																					
TankeredEffluent	3																					
LogicalWater	4																					
PseudoWater	5																					
source	<pre> <xs:simpleType name="MeterTreatmentType"> <xs:annotation> <xs:documentation> Enumeration of Meter Treatment indicator SWWater 0 PrivateWater 1 PrivateEffluent 2 TankeredEffluent 3 LogicalWater 4 PseudoWater 5 </xs:documentation> </xs:annotation> <xs:restriction base="xs:string"> <xs:enumeration value="SWWater"/> <xs:enumeration value="PrivateWater"/> <xs:enumeration value="PrivateEffluent"/> <xs:enumeration value="TankeredEffluent"/> <xs:enumeration value="LogicalWater"/> <xs:enumeration value="PseudoWater"/> </xs:restriction> </xs:simpleType> </pre>																					

simpleType NewConnectionType

namespace	urn:bridgeall-com:cmaservice:data:v3									
type	restriction of xs:string									
properties	base xs:string									
used by	element D2023 NewConnectionType									
facets	<table border="1"> <thead> <tr> <th>Kind</th> <th>Value</th> <th>annotation</th> </tr> </thead> <tbody> <tr> <td>enumeration</td> <td>NEW</td> <td></td> </tr> <tr> <td>enumeration</td> <td>GS</td> <td></td> </tr> </tbody> </table>	Kind	Value	annotation	enumeration	NEW		enumeration	GS	
Kind	Value	annotation								
enumeration	NEW									
enumeration	GS									

	enumeration CU
annotation	documentation New Connection Type NEW New GS Gap Site CU Change of Use
source	<pre> <xs:simpleType name="NewConnectionType"> <xs:annotation> <xs:documentation> New Connection Type NEW New GS Gap Site CU Change of Use </xs:documentation> </xs:annotation> <xs:restriction base="xs:string"> <xs:enumeration value="NEW"/> <xs:enumeration value="GS"/> <xs:enumeration value="CU"/> </xs:restriction> </xs:simpleType> </pre>

simpleType percentage

namespace	urn:bridgeall-com:cmaservice:data:v3															
type	restriction of xs:decimal															
properties	base xs:decimal															
used by	elements D2003 Schedule3 D2006 29e D2041 PcentExemption D3007 ReturnToSewerAllowance D3024 MDVol D6012 PcentAllowance															
facets	<table border="1"> <thead> <tr> <th>Kind</th> <th>Value</th> <th>annotation</th> </tr> </thead> <tbody> <tr> <td>minInclusive</td> <td>0</td> <td></td> </tr> <tr> <td>maxInclusive</td> <td>100</td> <td></td> </tr> <tr> <td>totalDigits</td> <td>5</td> <td></td> </tr> <tr> <td>fractionDigits</td> <td>2</td> <td></td> </tr> </tbody> </table>	Kind	Value	annotation	minInclusive	0		maxInclusive	100		totalDigits	5		fractionDigits	2	
Kind	Value	annotation														
minInclusive	0															
maxInclusive	100															
totalDigits	5															
fractionDigits	2															
source	<pre> <xs:simpleType name="percentage"> <xs:restriction base="xs:decimal"> <xs:totalDigits value="5"/> <xs:fractionDigits value="2"/> <xs:minInclusive value="0"/> <xs:maxInclusive value="100"/> </xs:restriction> </xs:simpleType> </pre>															

simpleType ReadFrequencyType

namespace	urn:bridgeall-com:cmaservice:data:v3									
type	restriction of xs:string									
properties	base xs:string									
used by	element D3011 MeterReadFrequency									
facets	<table border="1"> <thead> <tr> <th>Kind</th> <th>Value</th> <th>annotation</th> </tr> </thead> <tbody> <tr> <td>enumeration</td> <td>B</td> <td></td> </tr> <tr> <td>enumeration</td> <td>M</td> <td></td> </tr> </tbody> </table>	Kind	Value	annotation	enumeration	B		enumeration	M	
Kind	Value	annotation								
enumeration	B									
enumeration	M									

	enumeration N
annotation	documentation Enumeration of Meter Read Frequency B Bi-annually M Monthly N Never
source	<pre> <xs:simpleType name="ReadFrequencyType"> <xs:annotation> <xs:documentation> Enumeration of Meter Read Frequency B Bi-annually M Monthly N Never </xs:documentation> </xs:annotation> <xs:restriction base="xs:string"> <xs:enumeration value="B"/> <xs:enumeration value="M"/> <xs:enumeration value="N"/> </xs:restriction> </xs:simpleType> </pre>

simpleType ReadType

namespace	urn:bridgeall-com:cmaservice:data:v3																																				
type	restriction of xs:string																																				
properties	base xs:string																																				
used by	element D3010 MeterReadType																																				
facets	<table border="0"> <thead> <tr> <th>Kind</th> <th>Value</th> <th>annotation</th> </tr> </thead> <tbody> <tr><td>enumeration</td><td>O</td><td></td></tr> <tr><td>enumeration</td><td>E</td><td></td></tr> <tr><td>enumeration</td><td>I</td><td></td></tr> <tr><td>enumeration</td><td>F</td><td></td></tr> <tr><td>enumeration</td><td>C</td><td></td></tr> <tr><td>enumeration</td><td>U</td><td></td></tr> <tr><td>enumeration</td><td>T</td><td></td></tr> <tr><td>enumeration</td><td>X</td><td></td></tr> <tr><td>enumeration</td><td>Y</td><td></td></tr> <tr><td>enumeration</td><td>R</td><td></td></tr> <tr><td>enumeration</td><td>S</td><td></td></tr> </tbody> </table>	Kind	Value	annotation	enumeration	O		enumeration	E		enumeration	I		enumeration	F		enumeration	C		enumeration	U		enumeration	T		enumeration	X		enumeration	Y		enumeration	R		enumeration	S	
Kind	Value	annotation																																			
enumeration	O																																				
enumeration	E																																				
enumeration	I																																				
enumeration	F																																				
enumeration	C																																				
enumeration	U																																				
enumeration	T																																				
enumeration	X																																				
enumeration	Y																																				
enumeration	R																																				
enumeration	S																																				
annotation	documentation Enumeration of Meter Read Types O Opening Read E End Read I Initial Read F Final Read C Cyclic Read U Customer Read - if Cyclic Read supplied by Customer T Transfer Read X Temporary Disconnection Y Reconnection R AMR/Remote Read S Estimated T Read																																				

source	<pre> <xs:simpleType name="ReadType"> <xs:annotation> <xs:documentation> Enumeration of Meter Read Types O Opening Read E End Read I Initial Read F Final Read C Cyclic Read U Customer Read - if Cyclic Read supplied by Customer T Transfer Read X Temporary Disconnection Y Reconnection R AMR/Remote Read S Estimated T Read </xs:documentation> </xs:annotation> <xs:restriction base="xs:string"> <xs:enumeration value="O"/> <xs:enumeration value="E"/> <xs:enumeration value="I"/> <xs:enumeration value="F"/> <xs:enumeration value="C"/> <xs:enumeration value="U"/> <xs:enumeration value="T"/> <xs:enumeration value="X"/> <xs:enumeration value="Y"/> <xs:enumeration value="R"/> <xs:enumeration value="S"/> </xs:restriction> </xs:simpleType> </pre>
--------	---

simpleType ReturnCodeType

namespace	urn:bridgeall-com:cmaservice:data:v3																																																
type	restriction of xs:string																																																
properties	base xs:string																																																
used by	element D4004 ReturnCode																																																
facets	<table border="1"> <thead> <tr> <th>Kind</th> <th>Value</th> <th>annotation</th> </tr> </thead> <tbody> <tr><td>enumeration</td><td>AA</td><td></td></tr> <tr><td>enumeration</td><td>AB</td><td></td></tr> <tr><td>enumeration</td><td>AC</td><td></td></tr> <tr><td>enumeration</td><td>AD</td><td></td></tr> <tr><td>enumeration</td><td>AE</td><td></td></tr> <tr><td>enumeration</td><td>AF</td><td></td></tr> <tr><td>enumeration</td><td>AG</td><td></td></tr> <tr><td>enumeration</td><td>AH</td><td></td></tr> <tr><td>enumeration</td><td>AI</td><td></td></tr> <tr><td>enumeration</td><td>AJ</td><td></td></tr> <tr><td>enumeration</td><td>AK</td><td></td></tr> <tr><td>enumeration</td><td>AL</td><td></td></tr> <tr><td>enumeration</td><td>AM</td><td></td></tr> <tr><td>enumeration</td><td>AN</td><td></td></tr> <tr><td>enumeration</td><td>AO</td><td></td></tr> </tbody> </table>	Kind	Value	annotation	enumeration	AA		enumeration	AB		enumeration	AC		enumeration	AD		enumeration	AE		enumeration	AF		enumeration	AG		enumeration	AH		enumeration	AI		enumeration	AJ		enumeration	AK		enumeration	AL		enumeration	AM		enumeration	AN		enumeration	AO	
Kind	Value	annotation																																															
enumeration	AA																																																
enumeration	AB																																																
enumeration	AC																																																
enumeration	AD																																																
enumeration	AE																																																
enumeration	AF																																																
enumeration	AG																																																
enumeration	AH																																																
enumeration	AI																																																
enumeration	AJ																																																
enumeration	AK																																																
enumeration	AL																																																
enumeration	AM																																																
enumeration	AN																																																
enumeration	AO																																																

enumeration	AP
enumeration	AQ
enumeration	AR
enumeration	AS
enumeration	AT
enumeration	AU
enumeration	AV
enumeration	AW
enumeration	AX
enumeration	AY
enumeration	AZ
enumeration	BA
enumeration	BB
enumeration	BC
enumeration	BD
enumeration	BE
enumeration	BF
enumeration	BG
enumeration	BH
enumeration	BI
enumeration	BL
enumeration	BN
enumeration	BV
enumeration	BZ
enumeration	OK
enumeration	DA
enumeration	DB
enumeration	DC
enumeration	DD
enumeration	DE
enumeration	DF
enumeration	DG
enumeration	DH
enumeration	DI
enumeration	DJ
enumeration	DK
enumeration	DL
enumeration	DM
enumeration	DN
enumeration	DO
enumeration	DP
enumeration	DQ
enumeration	DR
enumeration	DS
enumeration	DT
enumeration	DU
enumeration	DV
enumeration	DW
enumeration	DX

enumeration	DY
enumeration	DZ
enumeration	EA
enumeration	EB
enumeration	EC
enumeration	ED
enumeration	EE
enumeration	EF
enumeration	EG
enumeration	EH
enumeration	EI
enumeration	EJ
enumeration	EK
enumeration	EL
enumeration	EM
enumeration	EN
enumeration	EO
enumeration	EP
enumeration	EQ
enumeration	ER
enumeration	ES
enumeration	ET
enumeration	EU
enumeration	EV
enumeration	EW
enumeration	EX
enumeration	EY
enumeration	EZ
enumeration	FA
enumeration	FB
enumeration	FC
enumeration	FD
enumeration	FE
enumeration	FF
enumeration	FG
enumeration	FH
enumeration	FI
enumeration	FJ
enumeration	FK
enumeration	FL
enumeration	FM
enumeration	FN
enumeration	FO
enumeration	FP
enumeration	FQ
enumeration	FR
enumeration	FS
enumeration	FT
enumeration	FU

enumeration	FV
enumeration	FW
enumeration	FX
enumeration	FY
enumeration	FZ
enumeration	GA
enumeration	GB
enumeration	GC
enumeration	GD
enumeration	GE
enumeration	GF
enumeration	GG
enumeration	GH
enumeration	GI
enumeration	GJ
enumeration	GK
enumeration	GL
enumeration	GM
enumeration	GN
enumeration	GO
enumeration	GP
enumeration	GQ
enumeration	GR
enumeration	GS
enumeration	GT
enumeration	GU
enumeration	GV
enumeration	GW
enumeration	GX
enumeration	GY
enumeration	GZ
enumeration	HA
enumeration	HB
enumeration	HC
enumeration	HD
enumeration	HE
enumeration	HF
enumeration	HG
enumeration	HH
enumeration	HI
enumeration	HJ
enumeration	HK
enumeration	HL
enumeration	HM
enumeration	HN
enumeration	HO
enumeration	HP
enumeration	HQ
enumeration	HR

enumeration	HS
enumeration	HT
enumeration	HU
enumeration	HV
enumeration	HW
enumeration	HX
enumeration	HY
enumeration	HZ
enumeration	IA
enumeration	IB
enumeration	IC
enumeration	ID
enumeration	IE
enumeration	IF
enumeration	IG
enumeration	IH
enumeration	II
enumeration	IJ
enumeration	IK
enumeration	IL
enumeration	IM
enumeration	IN
enumeration	IO
enumeration	IP
enumeration	IQ
enumeration	IR
enumeration	IS
enumeration	IT
enumeration	IU
enumeration	IV
enumeration	IW
enumeration	IX
enumeration	IY
enumeration	IZ
enumeration	JA
enumeration	JB
enumeration	JC
enumeration	JD
enumeration	JE
enumeration	JF
enumeration	JG
enumeration	JH
enumeration	JI
enumeration	JJ
enumeration	JK
enumeration	JL
enumeration	JM
enumeration	JN
enumeration	JO

	<p>enumeration JP</p> <p>enumeration JQ</p> <p>enumeration JR</p> <p>enumeration JS</p> <p>enumeration JT</p> <p>enumeration JU</p> <p>enumeration JV</p> <p>enumeration JW</p> <p>enumeration JX</p> <p>enumeration JY</p> <p>enumeration JZ</p> <p>enumeration KA</p> <p>enumeration KB</p> <p>enumeration KC</p> <p>enumeration KD</p> <p>enumeration KE</p> <p>enumeration KF</p> <p>enumeration KG</p> <p>enumeration KH</p> <p>enumeration KI</p> <p>enumeration KJ</p> <p>enumeration KK</p> <p>enumeration KL</p> <p>enumeration KM</p> <p>enumeration KN</p> <p>enumeration KO</p> <p>enumeration KP</p> <p>enumeration KQ</p> <p>enumeration KR</p> <p>enumeration KS</p> <p>enumeration XA</p>
annotation	<p>documentation</p> <p>AA Sender must be the valid Licensed Provider.</p> <p>AB SPID must be supplied in the transaction.</p> <p>AC SPID must exist in the CMA CS.</p> <p>AD Meter Read can only be submitted as a re-read if it is an exact duplicate of a rejected Read.</p> <p>AE SPID status must be Tradable.</p> <p>AF SPID status must be New.</p> <p>AG Data Items must be submitted for the WS SPID.</p> <p>AH Meter Read Y must be greater than or equal to Meter Read X.</p> <p>AI Connection Date must be in the past.</p> <p>AJ Meter S Read Remedial Work Indicator must be provided and set to False.</p> <p>AK Registration Start Date must be within the permitted window.</p> <p>AL Licensed Provider nominated by Scottish Water has rejected the registration of the new SPID.</p> <p>AM Transfer Cancellation must be within the Cancellation Window.</p> <p>AN Meter S Read Reason Code is not valid for the provided SPID.</p> <p>AO Taps/Troughs must be qualified as Farm or Croft.</p> <p>AP Meter must be Pending or Active.</p> <p>AQ SPID transfer to other Applicant already in progress.</p> <p>AR SPID already registered to Applicant, or transfer to Applicant already pending.</p> <p>AS Cancellation request not applicable to this Licensed Provider.</p> <p>AT Meter Read Rejected: Read type inappropriate.</p> <p>AU SPID Disconnection date must be today or in the past.</p> <p>AV SPID status must be Partial or Tradable.</p> <p>AW For Future Use.</p> <p>AX For Future Use.</p>

	<p>AY Meter being Swapped must be Active.</p> <p>AZ Meter can only be added to a WS SPID.</p> <p>BA For Future Use.</p> <p>BB Transaction not appropriate for Pseudo Meters.</p> <p>BC Meter not associated to a SPID.</p> <p>BD For Future Use.</p> <p>BE Meter Read must be within its capacity limit.</p> <p>BF Meter Read for this date already exists.</p> <p>BG Licensed Provider not registered to SPID.</p> <p>BH Meter Read must be on or below its daily usage limit.</p> <p>BI Meter Read date for the New Meter must be the same or after the Old Meter Read date.</p> <p>BL Meter Read must be on or above the daily usage minimum.</p> <p>BN Meter Read must create a positive meter advance, not a small negative advance.</p> <p>BV Meter Read must create a positive meter advance, not a large negative advance.</p> <p>BZ Meter Read must create a positive advance, not a zero advance.</p> <p>DA For Future Use.</p> <p>DB For Future Use.</p> <p>DC Transaction must be for a WS SPID.</p> <p>DD Service Category already exists for this connection.</p> <p>DE Old and New Meters incompatible for meter swap. Old Meter is not a domestic meter.</p> <p>DF Effective From date predates previous change.</p> <p>DG For Future Use.</p> <p>DH For Future Use.</p> <p>DI SPID has passed the switching limit.</p> <p>DJ Transaction must contain: Sender, Recipient, Timestamp, SPID.</p> <p>DK Effective From Date cannot be in the future.</p> <p>DL Sender must be wholesaler.</p> <p>DM DPID already exists.</p> <p>DN DPID is discontinued.</p> <p>DO DPID must be associated to the associated Sewerage SPID.</p> <p>DP DPID not associated with a Meter.</p> <p>DQ DPID already discontinued.</p> <p>DR DPID does not exist in the CMA CS.</p> <p>DS For Future Use.</p> <p>DT For Future Use.</p> <p>DU For Future Use.</p> <p>DV Customer Name must conform to the required format.</p> <p>DW For Future Use.</p> <p>DX SPID does not exist or it is a SS SPID that is paired with a WS SPID.</p> <p>DY Meter Is a Pseudo Meter.</p> <p>DZ SPID or Registration Start Date is not valid.</p> <p>EA GIS X, Y coordinates must be in Scotland.</p> <p>EB Comments field must be populated. The comment must be between 1 and 255 characters long.</p> <p>EC GIS X, Y data Incomplete.</p> <p>ED SPID must be a SS SPID.</p> <p>EE Rollover Indicator not consistent with CMA CS determination.</p> <p>EF Rollover Indicator required. CMA CS unable to determine the rollover status.</p> <p>EG SPID cannot be allocated. There are no Licensed Providers available for Gap Site allocation.</p> <p>EH For Future Use.</p> <p>EI Rollover Indicator must not be present on an O or an I read.</p> <p>EJ SPID status must not be; PDISC or DREG.</p> <p>EK For Future Use.</p> <p>EL For Future Use.</p> <p>EM For Future Use.</p> <p>EN SPID status is already TDISC.</p> <p>EO SPID status is must be TDISC.</p> <p>EP SPID must not be subject to a pending transfer for TDISC to proceed.</p> <p>EQ SPID must not be New or Partial.</p> <p>ER SPID must be New or Partial.</p> <p>ES For Future Use.</p> <p>ET SPID must not be; PDISC, DREG or REJ.</p> <p>EU SPID status must not be Unmeasureable.</p> <p>EV For Future Use.</p> <p>EW For Future Use.</p> <p>EX Licensed Provider Org ID does not match Sender Org ID.</p> <p>EY Meter does not exist in the CMA CS.</p> <p>EZ For Future Use.</p> <p>FA Meter already exists in the CMA CS.</p> <p>FB Transaction must include a Meter ID.</p> <p>FC Transaction must include a Meter Make.</p> <p>FD Transaction must include a Manufacturers Meter Serial Number.</p> <p>FE For Future Use.</p>
--	---

	<p>FF Meter Read Frequency must be N. FG Meter Chargeable Size must be 20mm. FH Meter is attached to a SPID and a SPID must be provided. FI For Future Use. FJ SPID status must be Tradable or TDISC. FK SPID should not be included for a Non-Market Meter. FL For Future Use. FM Meter: Both Old and New Meters must be included in the transaction. FN Meter: Old and/or New Meter must exist in the CMA CS. FO Old Meter read type must be E and/or New Meter Read type must be O, or New Meter has a previous reading. FP Meter must be Active. FQ Meter: Old and/or New Meter cannot be a Pseudo meter. FR Meter: Old and New Meters must contain same chargeable size and RTS. FS Meter: New Meter is in a Meter Network and cannot be swapped. FT Meter: New Meter must be Active or Pending. FU Sender must exist in CMA CS. FV Meter Read date must be later than the Effective To date of Unmeasurable Service Elements associated with the SPID. FW Meter Read must not be a duplicate I or a duplicate F read. FX Meter Read must be on a date after the last meter reading. FY For Future Use. FZ For Future Use. GA SPID status must be Partial. GB Meter Effective From date and/or Metered Building Water Flag values must be different to the current values in the CMA CS. GC Meter Effective From date must be on or after 1 April 2011. GD For Future Use. GE Data Items that are required have not been provided for this Meter Treatment type. GF SPID is New or Partial and must be Deregistered. GG Meter(s) at the SPID must be Discontinued. GH DPID(s) at the SPID must be Discontinued. GI Meter Read Date must be today or in the past. GJ SS SPID has been associated to a Tradable WS SPID at some point since the Effective From date. GK SPID has not been Tradable or TDISC continuously since the Effective From date. GL SPID must be continuously vacant from the Effective From date. GM Vacancy Admin Date of Evidence too early compared to the transaction date. GN Sender has transferred SPID since the Effective From date, or SPID transfer is pending. GO SPID must be continuously vacant from the Effective From date. GP SPID already has an existing Open Vacancy Application. GQ Vacancy Admin details do not match any opened T034.0 Vacancy Scheme Application. GR Vacancy Admin application has been previously closed. GS Vacancy Admin Grace Period has not yet elapsed (LP not yet notified). GT Vacancy Admin application rejected due to late T034.4. GU Date of Evidence must be in the past. GV SPID must not be New, Partial or REJ. GW SPID must be New, Partial or REJ. GX SS SPID must be connected via the WS SPID as the WS SPID is New, Partial or REJ. GY WS SPID must be (potentially) chargeable on given connection date. GZ SS SPID must be (potentially) chargeable on given date. HA Meter Read date must be greater than or equal to "2007-04-01". HB SPID has never been declared Unmeasurable or there are no Unmeasurable Service Elements active on or after the Effective From date. HC Meter cannot be swapped with itself. HD Meter Number of Digits cannot be changed. HE Meter Read digit count must be the same as the Meter digit count. HF For Future Use. HG For Future Use. HH For Future Use. HI For Future Use. HJ For Future Use. HK Return To Sewer Allowance must be zero for a Meter Treatment of Private Effluent or Tankered Effluent. HL Chargeable Meter Size must be zero for Meters with a Meter Treatment of; Private Water, Private Effluent, or Tankered Effluent. HM Meter Treatment must be the same for the Old and the New Meters. HN Return to Sewerage Allowance cannot be zero for Meters with Meter Treatment of SWWater, Private Water, or Logical Water that are associated to a DPID on the Effective From date. HO WS SPID must be associated with a Market Meter. HP SPID must be a SS SPID and must have an associated WS SPID. HQ WS SPID Transfer Meter Reads can only be sent by the Incoming LP. HR Sender must be the current LP.</p>
--	--

	<p>HS SS SPID of the DPID must be associated with the WS SPID of the Meter.</p> <p>HT MDVol value on the given Effective Date has already been set for the DPID-Meter Association.</p> <p>HU Return to Sewer should be greater than zero continuously from the Effective From Date.</p> <p>HV DPID has active meter associations.</p> <p>HW Sewerage Chargeable Meter Size must be zero for Private Effluent Meters and Tankered Effluent Meters.</p> <p>HX For Future Use.</p> <p>HY Meter Treatment of the Subtraction Meter must be the same as that of the Main Meter.</p> <p>HZ Meter Read rejected; the LP for the associated WS SPID should provide the Transfer read.</p> <p>IA For Future Use.</p> <p>IB Meter has previously been made active.</p> <p>IC Meter Network; The Sub SPID should not be the same as the Main SPID.</p> <p>ID For Future Use.</p> <p>IE MID Already Exists in the CMA CS.</p> <p>IF Meter is not associated to the provided SPID.</p> <p>IG Meter should have a Meter Treatment of SW Water or Private Water.</p> <p>IH Meter should have at least one meter reading.</p> <p>II Meter Network, Sub Meter is non-domestic but the Sub SPID Is not provided OR the Sub Meter is domestic yet a Sub SPID is provided.</p> <p>IJ Meter Network Association is already active for the requested period.</p> <p>IK Meter Network Association is already inactive for the requested period.</p> <p>IL Meter Network; Sub Meter can only be actively associated to one Main Meter at any given time.</p> <p>IM Meter Network Association does not exist between the Main Meter and the Sub Meter.</p> <p>IN Meter Network Activation date should be prior to the earlier of the Main & Sub End Dates.</p> <p>IO Meter Network Activation date should be after the later of the Main & Sub Start Dates.</p> <p>IP Meter is part of a Meter Network that is active at a date on or after the Final Read Date.</p> <p>IQ WS SPID or Associated SS SPID has more than one Unmeasurable on a given day on or after the Effective From Date.</p> <p>IR Metered period must not overlap with an Unmeasured period.</p> <p>IS SPID has been allocated via the Gap Site allocation process and cannot be rejected.</p> <p>IT Meter S Read Reason Code must be provided.</p> <p>IU Meter S Read Remedial Work Indicator must be provided and set to True.</p> <p>IV Percentage Exemption should only be provided if the Customer Exemption Flag is provided and is set to True.</p> <p>IW Percent Exemption value must be 50% or 100%.</p> <p>IX Sender Org ID does not exist in CMA CS.</p> <p>IY Associated WS SPID must not be Tradable or TDISC.</p> <p>IZ Effective From Date must be greater than the Effective To Date of the last instance of the WS SPID being either Tradable or TDISC.</p> <p>JA Meter IDs and DPIDs cannot include control characters.</p> <p>JB Meter S Read Reason Code and S Read Remedial Work Indicator should only be provided for S reads.</p> <p>JC SPID SAA Ref or SAA Ref Absence Code must be provided.</p> <p>JD SPID UPRN or the UPRN Absence Code must be provided.</p> <p>JE SPID SAA Ref and/or UPRN already exists in the CS against a SPID that is New, Partial, Tradable, TDISC, or Rejected.</p> <p>JF SPID SAA Ref and/or UPRN should match the existing value in the CMA CS.</p> <p>JG SPID SAA Ref is duplicated in SAA data - more information required.</p> <p>JH SPID SAA Ref and UPRN data must be provided.</p> <p>JI RA; Data Item must be specified.</p> <p>JJ RA; Value must be specified.</p> <p>JK RA; EFD must be specified.</p> <p>JL RA; DPID must be specified.</p> <p>JM RA; The specified Data Item is not updateable. Please check that the Data Item is valid for the selected template.</p> <p>JN RA; the provided Value must be consistent with the specified Data Item.</p> <p>JO RA; invalid date provided.</p> <p>JP RA; Physical Meter Size must be between 1 and 9999.</p> <p>JQ RA; record must be for a SS SPID.</p> <p>JR RA; D2024_Unmeasurable is incompatible with existing Metered Service Elements - cannot be effective during a Water Metered Period.</p> <p>JS RA; D2024_Unmeasurable is incompatible with existing Metered Service Elements - cannot be effective during a Foul Water Metered Period (with RTS > 0).</p> <p>JT RA; Effective From date must be after database entry.</p> <p>JU RA; Existing Meter Read Date must be specified.</p> <p>JV RA; at least one updatable field needs to be provided.</p> <p>JW RA; I and F reads for Pseudo Meters must be zero</p> <p>JX RA; invalid Meter Read value provided.</p> <p>JY RA; No Meter Read exists for specified existing read date.</p>
--	---

	<p>JZ RA; the specified Meter Read Type is not updatable via the RA Process.</p> <p>KA RA; this Read Type cannot be deleted.</p> <p>KB RA; Meter Read date must be before a different meter reading.</p> <p>KC RA; Meter Read must be lower than subsequent meter reading.</p> <p>KD RA; Meter Read must be after SPID Connection Date.</p> <p>KE RA; the Final Meter Read should be the last meter reading.</p> <p>KF RA; Meter Read date must be after different meter reading.</p> <p>KG RA; Meter Read must be greater than previous meter reading.</p> <p>KH RA; the Final read must be before the Disconnection/Deregistration Date.</p> <p>KI RA; the Opening Meter Read should be the first meter reading.</p> <p>KJ RA; Meter is not in a SWAP chain.</p> <p>KK RA; the End Meter Read should be the last meter reading.</p> <p>KL RA; SPID updates are only allowed to be made by the owning LP between the specified date ranges.</p> <p>KM RA; the incoming LP is only allowed to amend T and S Reads.</p> <p>KN RA; invalid Rollover value provided.</p> <p>KO SPID is currently Deregistered and so it cannot be Disconnected.</p> <p>KP SPID is currently Disconnected and so it cannot be Deregistered.</p> <p>KQ Rateable Value should be a whole number or one of the following 0.10, 999.90, 9,999.90, 19,999.90 or 99,999.90.</p> <p>KR Meter must be Pending for the read to be accepted.</p> <p>KS Meter must be Active for the read to be accepted.</p> <p>XA Licensed Provider rejects registration for a new SPID.</p>
source	<pre><xs:simpleType name="ReturnCodeType"> <xs:annotation> <xs:documentation></pre> <p>AA Sender must be the valid Licensed Provider.</p> <p>AB SPID must be supplied in the transaction.</p> <p>AC SPID must exist in the CMA CS.</p> <p>AD Meter Read can only be submitted as a re-read if it is an exact duplicate of a rejected Read.</p> <p>AE SPID status must be Tradable.</p> <p>AF SPID status must be New.</p> <p>AG Data Items must be submitted for the WS SPID.</p> <p>AH Meter Read Y must be greater than or equal to Meter Read X.</p> <p>AI Connection Date must be in the past.</p> <p>AJ Meter S Read Remedial Work Indicator must be provided and set to False.</p> <p>AK Registration Start Date must be within the permitted window.</p> <p>AL Licensed Provider nominated by Scottish Water has rejected the registration of the new SPID.</p> <p>AM Transfer Cancellation must be within the Cancellation Window.</p> <p>AN Meter S Read Reason Code is not valid for the provided SPID.</p> <p>AO Taps/Troughs must be qualified as Farm or Croft.</p> <p>AP Meter must be Pending or Active.</p> <p>AQ SPID transfer to other Applicant already in progress.</p> <p>AR SPID already registered to Applicant, or transfer to Applicant already pending.</p> <p>AS Cancellation request not applicable to this Licensed Provider.</p> <p>AT Meter Read Rejected: Read type inappropriate.</p> <p>AU SPID Disconnection date must be today or in the past.</p> <p>AV SPID status must be Partial or Tradable.</p> <p>AW For Future Use.</p> <p>AX For Future Use.</p> <p>AY Meter being Swapped must be Active.</p> <p>AZ Meter can only be added to a WS SPID.</p> <p>BA For Future Use.</p> <p>BB Transaction not appropriate for Pseudo Meters.</p> <p>BC Meter not associated to a SPID.</p> <p>BD For Future Use.</p> <p>BE Meter Read must be within its capacity limit.</p> <p>BF Meter Read for this date already exists.</p>

	<p>BG Licensed Provider not registered to SPID.</p> <p>BH Meter Read must be on or below its daily usage limit.</p> <p>BI Meter Read date for the New Meter must be the same or after the Old Meter Read date.</p> <p>BL Meter Read must be on or above the daily usage minimum.</p> <p>BN Meter Read must create a positive meter advance, not a small negative advance.</p> <p>BV Meter Read must create a positive meter advance, not a large negative advance.</p> <p>BZ Meter Read must create a positive advance, not a zero advance.</p> <p>DA For Future Use.</p> <p>DB For Future Use.</p> <p>DC Transaction must be for a WS SPID.</p> <p>DD Service Category already exists for this connection.</p> <p>DE Old and New Meters incompatible for meter swap. Old Meter is not a domestic meter.</p> <p>DF Effective From date predates previous change.</p> <p>DG For Future Use.</p> <p>DH For Future Use.</p> <p>DI SPID has passed the switching limit.</p> <p>DJ Transaction must contain: Sender, Recipient, Timestamp, SPID.</p> <p>DK Effective From Date cannot be in the future.</p> <p>DL Sender must be wholesaler.</p> <p>DM DPID already exists.</p> <p>DN DPID is discontinued.</p> <p>DO DPID must be associated to the associated Sewerage SPID.</p> <p>DP DPID not associated with a Meter.</p> <p>DQ DPID already discontinued.</p> <p>DR DPID does not exist in the CMA CS.</p> <p>DS For Future Use.</p> <p>DT For Future Use.</p> <p>DU For Future Use.</p> <p>DV Customer Name must conform to the required format.</p> <p>DW For Future Use.</p> <p>DX SPID does not exist or it is a SS SPID that is paired with a WS SPID.</p> <p>DY Meter Is a Pseudo Meter.</p> <p>DZ SPID or Registration Start Date is not valid.</p> <p>EAGIS X, Y coordinates must be in Scotland.</p> <p>EB Comments field must be populated. The comment must be between 1 and 255 characters long.</p> <p>EC GIS X, Y data Incomplete.</p> <p>ED SPID must be a SS SPID.</p> <p>EE Rollover Indicator not consistent with CMA CS determination.</p> <p>EF Rollover Indicator required. CMA CS unable to determine the rollover status.</p> <p>EG SPID cannot be allocated. There are no Licensed Providers available for Gap Site allocation.</p> <p>EH For Future Use.</p> <p>EI Rollover Indicator must not be present on an O or an I read.</p> <p>EJ SPID status must not be; PDISC or DREG.</p> <p>EK For Future Use.</p> <p>EL For Future Use.</p> <p>EM For Future Use.</p> <p>EN SPID status is already TDISC.</p> <p>EO SPID status is must be TDISC.</p> <p>EP SPID must not be subject to a pending transfer for TDISC to proceed.</p> <p>EQ SPID must not be New or Partial.</p> <p>ER SPID must be New or Partial.</p>
--	--

	<p>ES For Future Use.</p> <p>ET SPID must not be; PDISC, DREG or REJ.</p> <p>EU SPID status must not be Unmeasurable.</p> <p>EV For Future Use.</p> <p>EW For Future Use.</p> <p>EX Licensed Provider Org ID does not match Sender Org ID.</p> <p>EY Meter does not exist in the CMA CS.</p> <p>EZ For Future Use.</p> <p>FA Meter already exists in the CMA CS.</p> <p>FB Transaction must include a Meter ID.</p> <p>FC Transaction must include a Meter Make.</p> <p>FD Transaction must include a Manufacturers Meter Serial Number.</p> <p>FE For Future Use.</p> <p>FF Meter Read Frequency must be N.</p> <p>FG Meter Chargeable Size must be 20mm.</p> <p>FH Meter is attached to a SPID and a SPID must be provided.</p> <p>FI For Future Use.</p> <p>FJ SPID status must be Tradable or TDISC.</p> <p>FK SPID should not be included for a Non-Market Meter.</p> <p>FL For Future Use.</p> <p>FM Meter: Both Old and New Meters must be included in the transaction.</p> <p>FN Meter: Old and/or New Meter must exist in the CMA CS.</p> <p>FO Old Meter read type must be E and/or New Meter Read type must be O, or New Meter has a previous reading.</p> <p>FP Meter must be Active.</p> <p>FQ Meter: Old and/or New Meter cannot be a Pseudo meter.</p> <p>FR Meter: Old and New Meters must contain same chargeable size and RTS.</p> <p>FS Meter: New Meter is in a Meter Network and cannot be swapped.</p> <p>FT Meter: New Meter must be Active or Pending.</p> <p>FU Sender must exist in CMA CS.</p> <p>FV Meter Read date must be later than the Effective To date of Unmeasurable Service Elements associated with the SPID.</p> <p>FW Meter Read must not be a duplicate I or a duplicate F read.</p> <p>FX Meter Read must be on a date after the last meter reading.</p> <p>FY For Future Use.</p> <p>FZ For Future Use.</p> <p>GA SPID status must be Partial.</p> <p>GB Meter Effective From date and/or Metered Building Water Flag values must be different to the current values in the CMA CS.</p> <p>GC Meter Effective From date must be on or after 1 April 2011.</p> <p>GD For Future Use.</p> <p>GE Data Items that are required have not been provided for this Meter Treatment type.</p> <p>GF SPID is New or Partial and must be Deregistered.</p> <p>GG Meter(s) at the SPID must be Discontinued.</p> <p>GH DPID(s) at the SPID must be Discontinued.</p> <p>GI Meter Read Date must be today or in the past.</p> <p>GJ SS SPID has been associated to a Tradable WS SPID at some point since the Effective From date.</p> <p>GK SPID has not been Tradable or TDISC continuously since the Effective From date.</p> <p>GL SPID must be continuously vacant from the Effective From date.</p> <p>GM Vacancy Admin Date of Evidence too early compared to the transaction date.</p> <p>GN Sender has transferred SPID since the Effective From date, or SPID transfer is pending.</p> <p>GO SPID must be continuously vacant from the Effective From date.</p> <p>GP SPID already has an existing Open Vacancy Application.</p>
--	--

GQ	Vacancy Admin details do not match any opened T034.0 Vacancy Scheme Application.
GR	Vacancy Admin application has been previously closed.
GS	Vacancy Admin Grace Period has not yet elapsed (LP not yet notified).
GT	Vacancy Admin application rejected due to late T034.4.
GU	Date of Evidence must be in the past.
GV	SPID must not be New, Partial or REJ.
GW	SPID must be New, Partial or REJ.
GX	SS SPID must be connected via the WS SPID as the WS SPID is New, Partial or REJ.
GY	WS SPID must be (potentially) chargeable on given connection date.
GZ	SS SPID must be (potentially) chargeable on given date.
HA	Meter Read date must be greater than or equal to "2007-04-01".
HB	SPID has never been declared Unmeasurable or there are no Unmeasurable Service Elements active on or after the Effective From date.
HC	Meter cannot be swapped with itself.
HD	Meter Number of Digits cannot be changed.
HE	Meter Read digit count must be the same as the Meter digit count.
HFF	For Future Use.
HG	For Future Use.
HH	For Future Use.
HI	For Future Use.
HJ	For Future Use.
HK	Return To Sewer Allowance must be zero for a Meter Treatment of Private Effluent or Tankered Effluent.
HL	Chargeable Meter Size must be zero for Meters with a Meter Treatment of; Private Water, Private Effluent, or Tankered Effluent.
HM	Meter Treatment must be the same for the Old and the New Meters.
HN	Return to Sewerage Allowance cannot be zero for Meters with Meter Treatment of SWWater, Private Water, or Logical Water that are associated to a DPID on the Effective From date.
HO	WS SPID must be associated with a Market Meter.
HP	SPID must be a SS SPID and must have an associated WS SPID.
HQ	WS SPID Transfer Meter Reads can only be sent by the Incoming LP.
HR	Sender must be the current LP.
HS	SS SPID of the DPID must be associated with the WS SPID of the Meter.
HTMD	Vol value on the given Effective Date has already been set for the DPID-Meter Association.
HU	Return to Sewer should be greater than zero continuously from the Effective From Date.
HV	DPID has active meter associations.
HW	Sewerage Chargeable Meter Size must be zero for Private Effluent Meters and Tankered Effluent Meters.
HX	For Future Use.
HY	Meter Treatment of the Subtraction Meter must be the same as that of the Main Meter.
HZ	Meter Read rejected; the LP for the associated WS SPID should provide the Transfer read.
IA	For Future Use.
IB	Meter has previously been made active.
IC	Meter Network; The Sub SPID should not be the same as the Main SPID.
ID	For Future Use.

IE MID Already Exists in the CMA CS.

IF Meter is not associated to the provided SPID.

IG Meter should have a Meter Treatment of SW Water or Private Water.

IH Meter should have at least one meter reading.

II Meter Network, Sub Meter is non-domestic but the Sub SPID Is not provided OR the Sub Meter is domestic yet a Sub SPID is provided.

IJ Meter Network Association is already active for the requested period.

IK Meter Network Association is already inactive for the requested period.

IL Meter Network; Sub Meter can only be actively associated to one Main Meter at any given time.

IM Meter Network Association does not exist between the Main Meter and the Sub Meter.

IN Meter Network Activation date should be prior to the earlier of the Main & Sub End Dates.

IO Meter Network Activation date should be after the later of the Main & Sub Start Dates.

IP Meter is part of a Meter Network that is active at a date on or after the Final Read Date.

IQ WS SPID or Associated SS SPID has more than one Unmeasurable on a given day on or after the Effective From Date.

IR Metered period must not overlap with an Unmeasured period.

IS SPID has been allocated via the Gap Site allocation process and cannot be rejected.

IT Meter S Read Reason Code must be provided.

IU Meter S Read Remedial Work Indicator must be provided and set to True.

IV Percentage Exemption should only be provided if the Customer Exemption Flag is provided and is set to True.

IW Percent Exemption value must be 50% or 100% .

IX Sender Org ID does not exist in CMA CS.

IY Associated WS SPID must not be Tradable or TDISC.

IZ Effective From Date must be greater than the Effective To Date of the last instance of the WS SPID being either Tradable or TDISC.

JA Meter IDs and DPIDs cannot include control characters.

JB Meter S Read Reason Code and S Read Remedial Work Indicator should only be provided for S reads.

JC SPID SAA Ref or SAA Ref Absence Code must be provided.

JD SPID UPRN or the UPRN Absence Code must be provided.

JE SPID SAA Ref and/or UPRN already exists in the CS against a SPID that is New, Partial, Tradable, TDISC, or Rejected.

JF SPID SAA Ref and/or UPRN should match the existing value in the CMA CS .

JG SPID SAA Ref is duplicated in SAA data - more information required.

JH SPID SAA Ref and UPRN data must be provided.

JI RA; Data Item must be specified.

JJ RA; Value must be specified.

JK RA; EFD must be specified.

JL RA; DPID must be specified.

JMRA; The specified Data Item is not updateable. Please check that the Data Item is valid for the selected template.

JN RA; the provided Value must be consistent with the specified Data Item.

JORA; invalid date provided.

JP RA; Physical Meter Size must be between 1 and 9999.

JQ RA; record must be for a SS SPID.

JR RA; D2024_Unmeasurable is incompatible with existing Metered Service Elements - cannot be effective during a Water Metered Period.

JS RA; D2024_Unmeasurable is incompatible with existing Metered Service Elements - cannot be effective during a Foul Water Metered Period (with RTS > 0).

JT RA; Effective From date must be after database entry.

JU RA; Existing Meter Read Date must be specified.
 JV RA; at least one updatable field needs to be provided.
 JW RA; I and F reads for Pseudo Meters must be zero
 JX RA; invalid Meter Read value provided.
 JY RA; No Meter Read exists for specified existing read date.
 JZ RA; the specified Meter Read Type is not updatable via the RA Process.
 KARA; this Read Type cannot be deleted.
 KBRA; Meter Read date must be before a different meter reading.
 KC RA; Meter Read must be lower than subsequent meter reading.
 KD RA; Meter Read must be after SPID Connection Date.
 KERA; the Final Meter Read should be the last meter reading.
 KF RA; Meter Read date must be after different meter reading.
 KG RA; Meter Read must be greater than previous meter reading.
 KH RA; the Final read must be before the
 Disconnection/Deregistration Date.
 KI RA; the Opening Meter Read should be the first meter reading.
 KJ RA; Meter is not in a SWAP chain.
 KKRA; the End Meter Read should be the last meter reading.
 KL RA; SPID updates are only allowed to be made by the owning LP
 between the specified date ranges.
 KM RA; the incoming LP is only allowed to amend T and S Reads.
 KN RA; invalid Rollover value provided.
 KO SPID is currently Deregistered and so it cannot be Disconnected.
 KPSPID is currently Disconnected and so it cannot be Deregistered.
 KQ Rateable Value should be a whole number or one of the following
 0.10, 999.90, 9,999.90, 19,999.90 or 99,999.90.
 KR Meter must be Pending for the read to be accepted.
 KSMeter must be Active for the read to be accepted.
 XALicensed Provider rejects registration for a new SPID.

```

</xs:documentation>
</xs:annotation>
<xs:restriction base="xs:string">
  <xs:enumeration value="AA"/>
  <xs:enumeration value="AB"/>
  <xs:enumeration value="AC"/>
  <xs:enumeration value="AD"/>
  <xs:enumeration value="AE"/>
  <xs:enumeration value="AF"/>
  <xs:enumeration value="AG"/>
  <xs:enumeration value="AH"/>
  <xs:enumeration value="AI"/>
  <xs:enumeration value="AJ"/>
  <xs:enumeration value="AK"/>
  <xs:enumeration value="AL"/>
  <xs:enumeration value="AM"/>
  <xs:enumeration value="AN"/>
  <xs:enumeration value="AO"/>
  <xs:enumeration value="AP"/>
  <xs:enumeration value="AQ"/>
  <xs:enumeration value="AR"/>
  <xs:enumeration value="AS"/>
  <xs:enumeration value="AT"/>
  <xs:enumeration value="AU"/>
  <xs:enumeration value="AV"/>
  <xs:enumeration value="AW"/>
  <xs:enumeration value="AX"/>
  <xs:enumeration value="AY"/>
  <xs:enumeration value="AZ"/>
  <xs:enumeration value="BA"/>

```

```
<xs:enumeration value="BB"/>
<xs:enumeration value="BC"/>
<xs:enumeration value="BD"/>
<xs:enumeration value="BE"/>
<xs:enumeration value="BF"/>
<xs:enumeration value="BG"/>
<xs:enumeration value="BH"/>
<xs:enumeration value="BI"/>
<xs:enumeration value="BL"/>
<xs:enumeration value="BN"/>
<xs:enumeration value="BV"/>
<xs:enumeration value="BZ"/>
<xs:enumeration value="OK"/>
<xs:enumeration value="DA"/>
<xs:enumeration value="DB"/>
<xs:enumeration value="DC"/>
<xs:enumeration value="DD"/>
<xs:enumeration value="DE"/>
<xs:enumeration value="DF"/>
<xs:enumeration value="DG"/>
<xs:enumeration value="DH"/>
<xs:enumeration value="DI"/>
<xs:enumeration value="DJ"/>
<xs:enumeration value="DK"/>
<xs:enumeration value="DL"/>
<xs:enumeration value="DM"/>
<xs:enumeration value="DN"/>
<xs:enumeration value="DO"/>
<xs:enumeration value="DP"/>
<xs:enumeration value="DQ"/>
<xs:enumeration value="DR"/>
<xs:enumeration value="DS"/>
<xs:enumeration value="DT"/>
<xs:enumeration value="DU"/>
<xs:enumeration value="DV"/>
<xs:enumeration value="DW"/>
<xs:enumeration value="DX"/>
<xs:enumeration value="DY"/>
<xs:enumeration value="DZ"/>
<xs:enumeration value="EA"/>
<xs:enumeration value="EB"/>
<xs:enumeration value="EC"/>
<xs:enumeration value="ED"/>
<xs:enumeration value="EE"/>
<xs:enumeration value="EF"/>
<xs:enumeration value="EG"/>
<xs:enumeration value="EH"/>
<xs:enumeration value="EI"/>
<xs:enumeration value="EJ"/>
<xs:enumeration value="EK"/>
<xs:enumeration value="EL"/>
<xs:enumeration value="EM"/>
<xs:enumeration value="EN"/>
<xs:enumeration value="EO"/>
<xs:enumeration value="EP"/>
<xs:enumeration value="EQ"/>
<xs:enumeration value="ER"/>
<xs:enumeration value="ES"/>
<xs:enumeration value="ET"/>
```

```
<xs:enumeration value="EU"/>
<xs:enumeration value="EV"/>
<xs:enumeration value="EW"/>
<xs:enumeration value="EX"/>
<xs:enumeration value="EY"/>
<xs:enumeration value="EZ"/>
<xs:enumeration value="FA"/>
<xs:enumeration value="FB"/>
<xs:enumeration value="FC"/>
<xs:enumeration value="FD"/>
<xs:enumeration value="FE"/>
<xs:enumeration value="FF"/>
<xs:enumeration value="FG"/>
<xs:enumeration value="FH"/>
<xs:enumeration value="FI"/>
<xs:enumeration value="FJ"/>
<xs:enumeration value="FK"/>
<xs:enumeration value="FL"/>
<xs:enumeration value="FM"/>
<xs:enumeration value="FN"/>
<xs:enumeration value="FO"/>
<xs:enumeration value="FP"/>
<xs:enumeration value="FQ"/>
<xs:enumeration value="FR"/>
<xs:enumeration value="FS"/>
<xs:enumeration value="FT"/>
<xs:enumeration value="FU"/>
<xs:enumeration value="FV"/>
<xs:enumeration value="FW"/>
<xs:enumeration value="FX"/>
<xs:enumeration value="FY"/>
<xs:enumeration value="FZ"/>
<xs:enumeration value="GA"/>
<xs:enumeration value="GB"/>
<xs:enumeration value="GC"/>
<xs:enumeration value="GD"/>
<xs:enumeration value="GE"/>
<xs:enumeration value="GF"/>
<xs:enumeration value="GG"/>
<xs:enumeration value="GH"/>
<xs:enumeration value="GI"/>
<xs:enumeration value="GJ"/>
<xs:enumeration value="GK"/>
<xs:enumeration value="GL"/>
<xs:enumeration value="GM"/>
<xs:enumeration value="GN"/>
<xs:enumeration value="GO"/>
<xs:enumeration value="GP"/>
<xs:enumeration value="GQ"/>
<xs:enumeration value="GR"/>
<xs:enumeration value="GS"/>
<xs:enumeration value="GT"/>
<xs:enumeration value="GU"/>
<xs:enumeration value="GV"/>
<xs:enumeration value="GW"/>
<xs:enumeration value="GX"/>
<xs:enumeration value="GY"/>
<xs:enumeration value="GZ"/>
<xs:enumeration value="HA"/>
```



```
<xs:enumeration value="HB"/>
<xs:enumeration value="HC"/>
<xs:enumeration value="HD"/>
<xs:enumeration value="HE"/>
<xs:enumeration value="HF"/>
<xs:enumeration value="HG"/>
<xs:enumeration value="HH"/>
<xs:enumeration value="HI"/>
<xs:enumeration value="HJ"/>
<xs:enumeration value="HK"/>
<xs:enumeration value="HL"/>
<xs:enumeration value="HM"/>
<xs:enumeration value="HN"/>
<xs:enumeration value="HO"/>
<xs:enumeration value="HP"/>
<xs:enumeration value="HQ"/>
<xs:enumeration value="HR"/>
<xs:enumeration value="HS"/>
<xs:enumeration value="HT"/>
<xs:enumeration value="HU"/>
<xs:enumeration value="HV"/>
<xs:enumeration value="HW"/>
<xs:enumeration value="HX"/>
<xs:enumeration value="HY"/>
<xs:enumeration value="HZ"/>
<xs:enumeration value="IA"/>
<xs:enumeration value="IB"/>
<xs:enumeration value="IC"/>
<xs:enumeration value="ID"/>
<xs:enumeration value="IE"/>
<xs:enumeration value="IF"/>
<xs:enumeration value="IG"/>
<xs:enumeration value="IH"/>
<xs:enumeration value="II"/>
<xs:enumeration value="IJ"/>
<xs:enumeration value="IK"/>
<xs:enumeration value="IL"/>
<xs:enumeration value="IM"/>
<xs:enumeration value="IN"/>
<xs:enumeration value="IO"/>
<xs:enumeration value="IP"/>
<xs:enumeration value="IQ"/>
<xs:enumeration value="IR"/>
<xs:enumeration value="IS"/>
<xs:enumeration value="IT"/>
<xs:enumeration value="IU"/>
<xs:enumeration value="IV"/>
<xs:enumeration value="IW"/>
<xs:enumeration value="IX"/>
<xs:enumeration value="IY"/>
<xs:enumeration value="IZ"/>
<xs:enumeration value="JA"/>
<xs:enumeration value="JB"/>
<xs:enumeration value="JC"/>
<xs:enumeration value="JD"/>
<xs:enumeration value="JE"/>
<xs:enumeration value="JF"/>
<xs:enumeration value="JG"/>
<xs:enumeration value="JH"/>
```

	<pre> <xs:enumeration value="JI"/> <xs:enumeration value="JJ"/> <xs:enumeration value="JK"/> <xs:enumeration value="JL"/> <xs:enumeration value="JM"/> <xs:enumeration value="JN"/> <xs:enumeration value="JO"/> <xs:enumeration value="JP"/> <xs:enumeration value="JQ"/> <xs:enumeration value="JR"/> <xs:enumeration value="JS"/> <xs:enumeration value="JT"/> <xs:enumeration value="JU"/> <xs:enumeration value="JV"/> <xs:enumeration value="JW"/> <xs:enumeration value="JX"/> <xs:enumeration value="JY"/> <xs:enumeration value="JZ"/> <xs:enumeration value="KA"/> <xs:enumeration value="KB"/> <xs:enumeration value="KC"/> <xs:enumeration value="KD"/> <xs:enumeration value="KE"/> <xs:enumeration value="KF"/> <xs:enumeration value="KG"/> <xs:enumeration value="KH"/> <xs:enumeration value="KI"/> <xs:enumeration value="KJ"/> <xs:enumeration value="KK"/> <xs:enumeration value="KL"/> <xs:enumeration value="KM"/> <xs:enumeration value="KN"/> <xs:enumeration value="KO"/> <xs:enumeration value="KP"/> <xs:enumeration value="KQ"/> <xs:enumeration value="KR"/> <xs:enumeration value="KS"/> <xs:enumeration value="XA"/> </xs:restriction> </xs:simpleType> </pre>
--	---

simpleType **ServiceCategoryType**

namespace	urn:bridgeall-com:cmaservice:data:v3									
type	restriction of xs:string									
properties	base xs:string									
used by	elements D2002_ServiceCategory_NewSPIDRequestType/D2002_ServiceCategory									
facets	<table border="1"> <thead> <tr> <th>Kind</th> <th>Value</th> <th>annotation</th> </tr> </thead> <tbody> <tr> <td>enumeration</td> <td>01</td> <td></td> </tr> <tr> <td>enumeration</td> <td>02</td> <td></td> </tr> </tbody> </table>	Kind	Value	annotation	enumeration	01		enumeration	02	
Kind	Value	annotation								
enumeration	01									
enumeration	02									
annotation	<p>documentation</p> <p>Enumeration of service categories 01 - Water 02 - Sewerage</p>									
source	<xs:simpleType name="ServiceCategoryType">									

	<pre> <xs:annotation> <xs:documentation> Enumeration of service categories 01 - Water 02 - Sewerage </xs:documentation> </xs:annotation> <xs:restriction base="xs:string"> <xs:enumeration value="01"/> <xs:enumeration value="02"/> </xs:restriction> </xs:simpleType> </pre>
--	--

simpleType **SReadReasonCodeType**

namespace	urn:bridgeall-com:cmaservice:data:v3																		
type	restriction of xs:string																		
properties	base xs:string																		
used by	element D3028 SReadReasonCode																		
facets	<table border="1"> <thead> <tr> <th>Kind</th> <th>Value</th> <th>annotation</th> </tr> </thead> <tbody> <tr> <td>enumeration</td> <td>WMD</td> <td></td> </tr> <tr> <td>enumeration</td> <td>NMA</td> <td></td> </tr> <tr> <td>enumeration</td> <td>MNF</td> <td></td> </tr> <tr> <td>enumeration</td> <td>NSA</td> <td></td> </tr> <tr> <td>enumeration</td> <td>PLR</td> <td></td> </tr> </tbody> </table>	Kind	Value	annotation	enumeration	WMD		enumeration	NMA		enumeration	MNF		enumeration	NSA		enumeration	PLR	
Kind	Value	annotation																	
enumeration	WMD																		
enumeration	NMA																		
enumeration	MNF																		
enumeration	NSA																		
enumeration	PLR																		
annotation	<p>documentation</p> <p>S Read Reason Code WMD Wrong Meter Details NMA No Meter Access MNF Meter Not Found NSA No Site Access PLR PoLR Transfer</p>																		
source	<pre> <xs:simpleType name="SReadReasonCodeType"> <xs:annotation> <xs:documentation> S Read Reason Code WMD Wrong Meter Details NMA No Meter Access MNF Meter Not Found NSA No Site Access PLR PoLR Transfer </xs:documentation> </xs:annotation> <xs:restriction base="xs:string"> <xs:enumeration value="WMD"/> <xs:enumeration value="NMA"/> <xs:enumeration value="MNF"/> <xs:enumeration value="NSA"/> <xs:enumeration value="PLR"/> </xs:restriction> </xs:simpleType> </pre>																		

simpleType **string32**

namespace	urn:bridgeall-com:cmaservice:data:v3												
type	restriction of xs:string												
properties	base xs:string												
used by	elements D3001 MeterId D3013 MeterMake D3014 ManufacturerMeterSerialNr D3027 MainMeterId D6001 DPID												
facets	<table border="1"> <thead> <tr> <th>Kind</th> <th>Value</th> <th>annotation</th> </tr> </thead> <tbody> <tr> <td>minLength</td> <td>1</td> <td></td> </tr> <tr> <td>maxLength</td> <td>32</td> <td></td> </tr> <tr> <td>pattern</td> <td> $([\^, \t\n\r])^*$ </td> <td></td> </tr> </tbody> </table>	Kind	Value	annotation	minLength	1		maxLength	32		pattern	$([\^, \t\n\r])^*$	
Kind	Value	annotation											
minLength	1												
maxLength	32												
pattern	$([\^, \t\n\r])^*$												
source	<pre> <xs:simpleType name="string32"> <xs:restriction base="xs:string"> <xs:maxLength value="32"/> <xs:minLength value="1"/> <xs:pattern value="([\^, \t\n\r])*"/> </xs:restriction> </xs:simpleType> </pre>												

simpleType **TETreatmentType**

namespace	urn:bridgeall-com:cmaservice:data:v3												
type	restriction of xs:string												
properties	base xs:string												
used by	element D6011 TETreatment												
facets	<table border="1"> <thead> <tr> <th>Kind</th> <th>Value</th> <th>annotation</th> </tr> </thead> <tbody> <tr> <td>enumeration</td> <td>Secondary</td> <td></td> </tr> <tr> <td>enumeration</td> <td>Primary</td> <td></td> </tr> <tr> <td>enumeration</td> <td>Sub-Primary</td> <td></td> </tr> </tbody> </table>	Kind	Value	annotation	enumeration	Secondary		enumeration	Primary		enumeration	Sub-Primary	
Kind	Value	annotation											
enumeration	Secondary												
enumeration	Primary												
enumeration	Sub-Primary												
annotation	<p>documentation</p> <table border="1"> <tbody> <tr> <td colspan="3">Enumeration of TETreatment indicator</td> </tr> <tr> <td>Secondary</td> <td>0</td> <td></td> </tr> <tr> <td>Primary</td> <td></td> <td>1</td> </tr> <tr> <td>Sub-Primary</td> <td>2</td> <td></td> </tr> </tbody> </table>	Enumeration of TETreatment indicator			Secondary	0		Primary		1	Sub-Primary	2	
Enumeration of TETreatment indicator													
Secondary	0												
Primary		1											
Sub-Primary	2												
source	<pre> <xs:simpleType name="TETreatmentType"> <xs:annotation> <xs:documentation> Enumeration of TETreatment indicator Secondary 0 Primary 1 Sub-Primary 2 </xs:documentation> </xs:annotation> <xs:restriction base="xs:string"> <xs:enumeration value="Secondary"/> <xs:enumeration value="Primary"/> <xs:enumeration value="Sub-Primary"/> </xs:restriction> </xs:simpleType> </pre>												

simpleType **UARNAbsenceCodeType**

namespace	urn:bridgeall-com:cmaservice:data:v3
-----------	--------------------------------------

type	restriction of xs:string																																				
properties	base xs:string																																				
used by	element UARNTyp/D2038 SAAReferenceNumberAbsenceCode																																				
facets	<table border="1"> <thead> <tr> <th>Kind</th> <th>Value</th> <th>annotation</th> </tr> </thead> <tbody> <tr><td>enumeration</td><td>ME</td><td></td></tr> <tr><td>enumeration</td><td>AG</td><td></td></tr> <tr><td>enumeration</td><td>SR</td><td></td></tr> <tr><td>enumeration</td><td>RC</td><td></td></tr> <tr><td>enumeration</td><td>MT</td><td></td></tr> <tr><td>enumeration</td><td>CU</td><td></td></tr> <tr><td>enumeration</td><td>IP</td><td></td></tr> <tr><td>enumeration</td><td>BW</td><td></td></tr> <tr><td>enumeration</td><td>OT</td><td></td></tr> <tr><td>enumeration</td><td>NR</td><td></td></tr> <tr><td>enumeration</td><td>CP</td><td></td></tr> </tbody> </table>	Kind	Value	annotation	enumeration	ME		enumeration	AG		enumeration	SR		enumeration	RC		enumeration	MT		enumeration	CU		enumeration	IP		enumeration	BW		enumeration	OT		enumeration	NR		enumeration	CP	
Kind	Value	annotation																																			
enumeration	ME																																				
enumeration	AG																																				
enumeration	SR																																				
enumeration	RC																																				
enumeration	MT																																				
enumeration	CU																																				
enumeration	IP																																				
enumeration	BW																																				
enumeration	OT																																				
enumeration	NR																																				
enumeration	CP																																				
annotation	<p>documentation</p> <table border="1"> <tbody> <tr><td colspan="3">SAA Reference Number Absence Code</td></tr> <tr><td>ME</td><td>0</td><td>Missing Entry from the SAA</td></tr> <tr><td>AG</td><td>1</td><td>Agricultural land, buildings and troughs</td></tr> <tr><td>SR</td><td>2</td><td>Fish farms, fishing, and sporting rights</td></tr> <tr><td>RC</td><td>3</td><td>Parks, Allotments and Sports Grounds</td></tr> <tr><td>MT</td><td>4</td><td>Property is multi-tenancy</td></tr> <tr><td>CU</td><td>5</td><td>Cumulo Supply Point</td></tr> <tr><td>IP</td><td>6</td><td>Infrastructure Project</td></tr> <tr><td>BW</td><td>7</td><td>Building Water</td></tr> <tr><td>OT</td><td>8</td><td>Other</td></tr> <tr><td>NR</td><td>9</td><td>Property not yet rated</td></tr> <tr><td>CP</td><td>10</td><td>Car Park</td></tr> </tbody> </table>	SAA Reference Number Absence Code			ME	0	Missing Entry from the SAA	AG	1	Agricultural land, buildings and troughs	SR	2	Fish farms, fishing, and sporting rights	RC	3	Parks, Allotments and Sports Grounds	MT	4	Property is multi-tenancy	CU	5	Cumulo Supply Point	IP	6	Infrastructure Project	BW	7	Building Water	OT	8	Other	NR	9	Property not yet rated	CP	10	Car Park
SAA Reference Number Absence Code																																					
ME	0	Missing Entry from the SAA																																			
AG	1	Agricultural land, buildings and troughs																																			
SR	2	Fish farms, fishing, and sporting rights																																			
RC	3	Parks, Allotments and Sports Grounds																																			
MT	4	Property is multi-tenancy																																			
CU	5	Cumulo Supply Point																																			
IP	6	Infrastructure Project																																			
BW	7	Building Water																																			
OT	8	Other																																			
NR	9	Property not yet rated																																			
CP	10	Car Park																																			
source	<pre> <xs:simpleType name="UARNAbsenceCodeType"> <xs:annotation> <xs:documentation> SAA Reference Number Absence Code ME 0 Missing Entry from the SAA AG 1 Agricultural land, buildings and troughs SR 2 Fish farms, fishing, and sporting rights RC 3 Parks, Allotments and Sports Grounds MT 4 Property is multi-tenancy CU 5 Cumulo Supply Point IP 6 Infrastructure Project BW 7 Building Water OT 8 Other NR 9 Property not yet rated CP 10 Car Park </xs:documentation> </xs:annotation> <xs:restriction base="xs:string"> <xs:enumeration value="ME"/> <xs:enumeration value="AG"/> <xs:enumeration value="SR"/> <xs:enumeration value="RC"/> <xs:enumeration value="MT"/> <xs:enumeration value="CU"/> <xs:enumeration value="IP"/> <xs:enumeration value="BW"/> <xs:enumeration value="OT"/> <xs:enumeration value="NR"/> </xs:restriction> </xs:simpleType> </pre>																																				

	<pre><xs:enumeration value="CP"/> </xs:restriction> </xs:simpleType></pre>
--	--

simpleType **UPRNAbsenceCodeType**

namespace	urn:bridgeall-com:cmaservice:data:v3																																	
type	restriction of xs:string																																	
properties	base xs:string																																	
used by	element UPRNType/D2040 UPRNAbsenceCode																																	
facets	<table border="1"> <thead> <tr> <th>Kind</th> <th>Value</th> <th>annotation</th> </tr> </thead> <tbody> <tr><td>enumeration</td><td>ME</td><td></td></tr> <tr><td>enumeration</td><td>AG</td><td></td></tr> <tr><td>enumeration</td><td>SR</td><td></td></tr> <tr><td>enumeration</td><td>RC</td><td></td></tr> <tr><td>enumeration</td><td>MT</td><td></td></tr> <tr><td>enumeration</td><td>CU</td><td></td></tr> <tr><td>enumeration</td><td>IP</td><td></td></tr> <tr><td>enumeration</td><td>BW</td><td></td></tr> <tr><td>enumeration</td><td>OT</td><td></td></tr> <tr><td>enumeration</td><td>PL</td><td></td></tr> </tbody> </table>	Kind	Value	annotation	enumeration	ME		enumeration	AG		enumeration	SR		enumeration	RC		enumeration	MT		enumeration	CU		enumeration	IP		enumeration	BW		enumeration	OT		enumeration	PL	
Kind	Value	annotation																																
enumeration	ME																																	
enumeration	AG																																	
enumeration	SR																																	
enumeration	RC																																	
enumeration	MT																																	
enumeration	CU																																	
enumeration	IP																																	
enumeration	BW																																	
enumeration	OT																																	
enumeration	PL																																	
annotation	<p>documentation</p> <pre>UPRN Absence Code ME 0 Missing Entry from the OSG AG 1 Agricultural including troughs SR 2 Fish farms, fishing, and sporting rights RC 3 Parks, Allotments and Sports Grounds MT 4 Property is multi-tenancy CU 5 Cumulo Supply Point IP 6 Infrastructure Project BW 7 Building Water OT 8 Other PL 9 Not yet issued by planning</pre>																																	
source	<pre><xs:simpleType name="UPRNAbsenceCodeType"> <xs:annotation> <xs:documentation> UPRN Absence Code ME 0 Missing Entry from the OSG AG 1 Agricultural including troughs SR 2 Fish farms, fishing, and sporting rights RC 3 Parks, Allotments and Sports Grounds MT 4 Property is multi-tenancy CU 5 Cumulo Supply Point IP 6 Infrastructure Project BW 7 Building Water OT 8 Other PL 9 Not yet issued by planning </xs:documentation> </xs:annotation> <xs:restriction base="xs:string"> <xs:enumeration value="ME"/> <xs:enumeration value="AG"/> <xs:enumeration value="SR"/> <xs:enumeration value="RC"/> <xs:enumeration value="MT"/></pre>																																	

	<pre><xs:enumeration value="CU"/> <xs:enumeration value="IP"/> <xs:enumeration value="BW"/> <xs:enumeration value="OT"/> <xs:enumeration value="PL"/> </xs:restriction> </xs:simpleType></pre>
--	--