

Market Code Schedule 20

Code Subsidiary Document CSD 0301

Data Transaction Catalogue Annex A

Version: 16.0

Date: 2017-09-28

Document Ref: CSD0301 Annex A

Change History

| Version Number | Date of Issue | Reason For Change | Change Control Reference | Sections Affected |
|----------------|---------------|-----------------------------------------------|--------------------------|-------------------------|
| 1.1 | 10/08/2007 | Created from CMA Interface Specification v1.0 | | |
| 1.2 | 17/10/2007 | Updated for XML schema v3.9 | | Appendix B |
| 1.3 | 17/08/2009 | Re-assessed Charges | MCCP035-CC | Appendix B |
| 1.4 | 28/06/2010 | Customer Names on Database | MCCP041-CC | Appendix B |
| 1.5 | 27/09/2010 | September 2010 Release | | Appendix A, Appendix B |
| 1.6 | 23/03/2011 | March 2011 Release | | Appendix B |
| 1.7 | 15/11/2011 | September 2011 Release v3.1 | | Appendix B |
| 1.8 | 30/03/2012 | March 2012 Release v3.2 | | Appendix B |
| 2.0 | 21/06/2012 | June 2012 Release v3.3 | | Appendix B |
| 3.0 | 28/09/2012 | September 2012 Release v3.4 | | Appendix B |
| 4.0 | 20/03/2013 | March 2013 Release v3.5 | | Appendix B |
| 5.0 | 21/08/2013 | September 2013 Release v3.6 | | Appendix B |
| 6.0 | 04/03/2014 | March 2014 Release v3.7 | | Appendix B |
| 7.0 | 15/09/2014 | September 2014 Release v4.1 | | Appendix B |
| 8.0 | 31/03/2015 | March 2015 Release v4.2 | | Section 3 Appendix B |
| 9.0 | 03/06/2015 | No Changes. Alignment with CSD0301 | MCCP177 | Change History |

| | | | | |
|------|------------|------------------------------------|---------|----------------|
| 10.0 | 24/06/2015 | No changes, Alignment with CSD0301 | MCCP179 | Change History |
| 11.0 | 04/09/2015 | September 2015 Release v4.3 | | Appendix B |
| 12.0 | 16/12/2015 | March 2016 Release v4.4 | | Appendix B |
| 13.0 | 28/04/2016 | May 2016 Release v4.4.1 | | Appendix B |
| 14.0 | 06/09/2016 | September 2016 Release v4.5 | | Appendix B |
| 15.0 | 09/02/2017 | March 2017 Release v4.6 | | Appendix B |
| 16.0 | 18/07/2017 | September 2017 Release v4.7 | | Appendix B |

Table of Contents

| | | |
|-----|---------------------------------------------------------------------------------|-----------|
| 1. | Introduction | 5 |
| 2. | Overview | 6 |
| 3. | Transport and Message Level Security | 6 |
| 3.1 | Process | 6 |
| 3.2 | The client initialises and sends a message with X.509 certificate information. | 7 |
| 3.3 | The service authenticates the client using the X.509 certificate and signature. | 8 |
| 4. | Message Submission and Retrieval | 11 |
| 4.1 | High level view of message exchange | 13 |
| 4.2 | CMA Messages in detail | 16 |
| 4.3 | Submission of document | 17 |
| 4.4 | Requesting New Messages | 18 |
| 4.5 | Handling Optional Data | 20 |
| | Appendix A – Web Services Definition Language (WSDL) | 22 |
| | Appendix B – XML Schema Documentation | 24 |

1. Introduction

The Central Systems provides two types of interface via which Trading Parties (wholesaler and licensed providers) may communicate with the CMA. The Low Volume Interface (LVI) consists of a web based user interface via which market participants may submit messages and receive notifications from the CMA. The High Volume Interface (HVI) is intended to allow market participants with high transaction volumes to make the submissions to the CMA and fetch responses and notifications systematically. This document describes only the High Volume Interface.

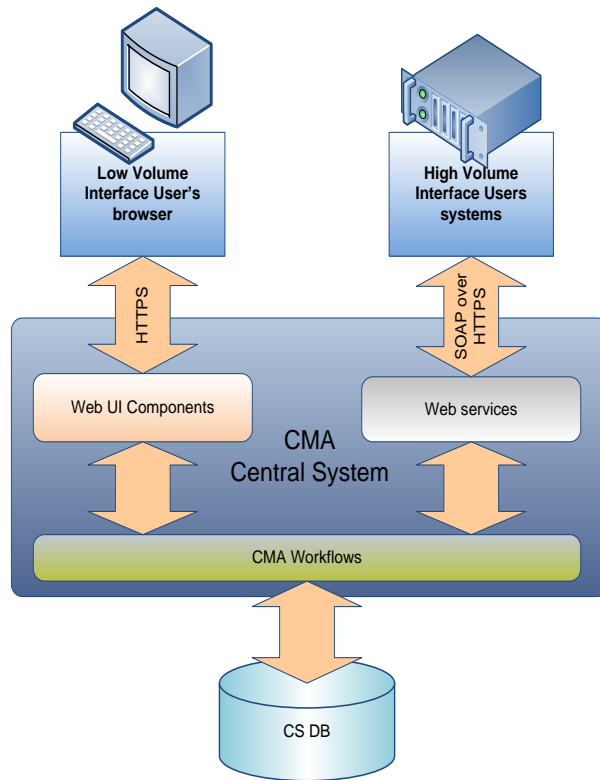

LVI (Web UI Components) and HVI (Web services)

2. Overview

The CMA HVI web service has been implemented using Message Layer Security with X.509 certificates and WSE 3.0. The objectives of this are:

- To secure message exchange between two parties using brokered authentication with X509.Certificates
- To combine an implementation of mutual authentication message exchange between client and server
- To ensure data origin authentication and data confidentiality.

Full details of best practice can be found at:

<http://msdn.microsoft.com/en-us/library/aa480565.aspx>

<http://msdn.microsoft.com/en-us/library/aa480581.aspx>

3. Transport and Message Level Security

The transport mechanism is based on TLS over HTTP. The client application must request an TLS session from the CMA server. The client must send a signed SOAP document to the CMA and wait for a synchronous response. The sending party should receive a response message or a system timeout. If a timeout occurs the sending party should retry sending the same message (with the same MID).

Each message sent to the CMA Central Systems must be a digitally signed, well formed and a valid XML document conforming to the CMADData Schema Document (see Appendix B for schema documentation). The XML document should be wrapped in a SOAP 1.2 envelope and be transported to the CMA using HTTPS. The sending party must establish a secure connection over the public Internet using the Transport Layer Security (TLS) protocol version 1.0+. Multiple messages can be sent in one document, but they must be of the same type. The CMA may return a single document with multiple messages of different types.

3.1 Process

Using message layer security with X.509 certificates in WSE 3.0 involves the following participants:

Client. The client accesses the Web service, and provides credentials for authentication during the request to the Web service.

Service. The service is the Web service that requires authentication of the client to make access control decisions. In our case the HVI.

The steps provided are based on the behaviour of the mutualCertificate10Security assertion. The steps are divided into the following two sections based on what happens on the client and then on the service:

- The client initializes and sends a message with X.509 certificate information.
- The service authenticates the client using the X.509 certificate and signature.

3.2 The client initialises and sends a message with X.509 certificate information.

This part of the process has six steps:

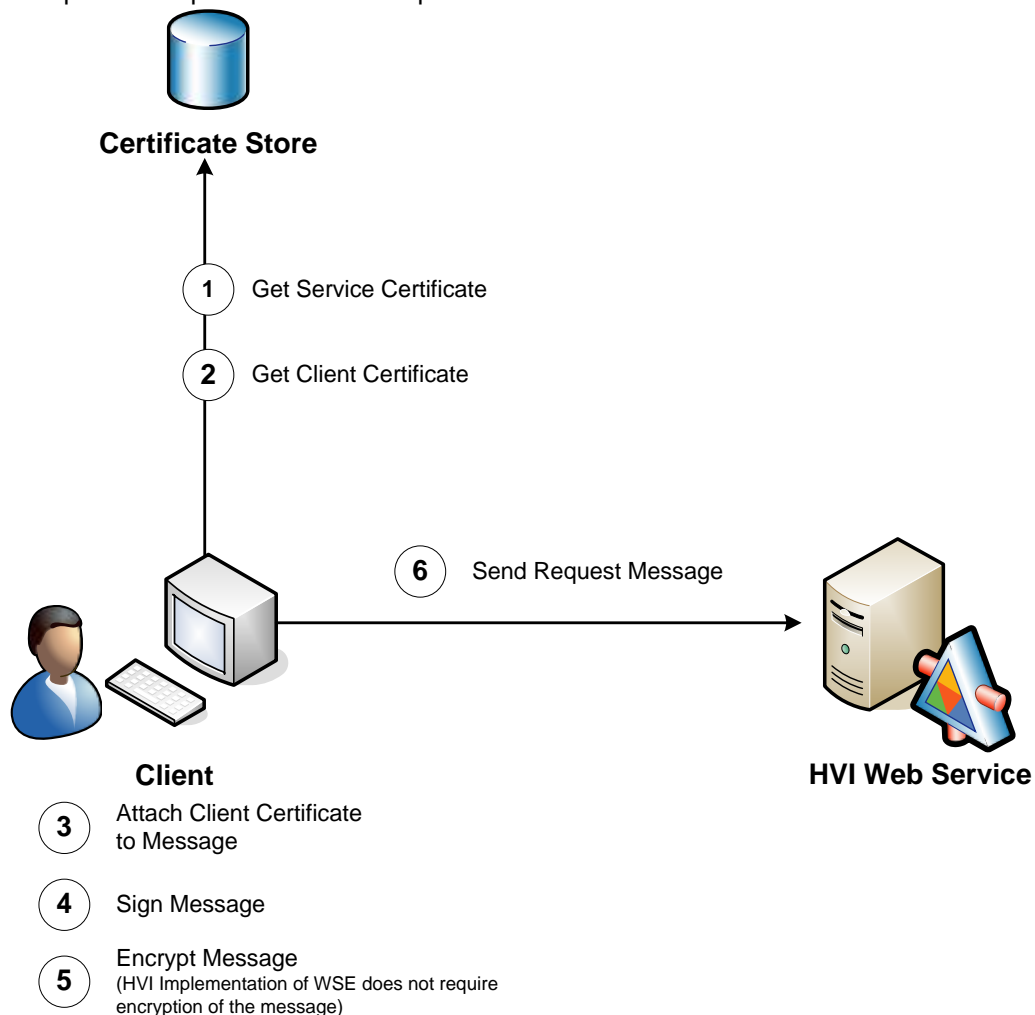

1. The client retrieves the service's X.509 certificate.
2. The client retrieves its own certificate and private key.

3. The client attaches its X.509 certificate to a message.
4. The client signs the message using its private key.
5. The client encrypts the message using the service's public key. **(In the HVI Implementation of this is not required)**
6. The client sends the message to the service.

3.3 The service authenticates the client using the X.509 certificate and signature.

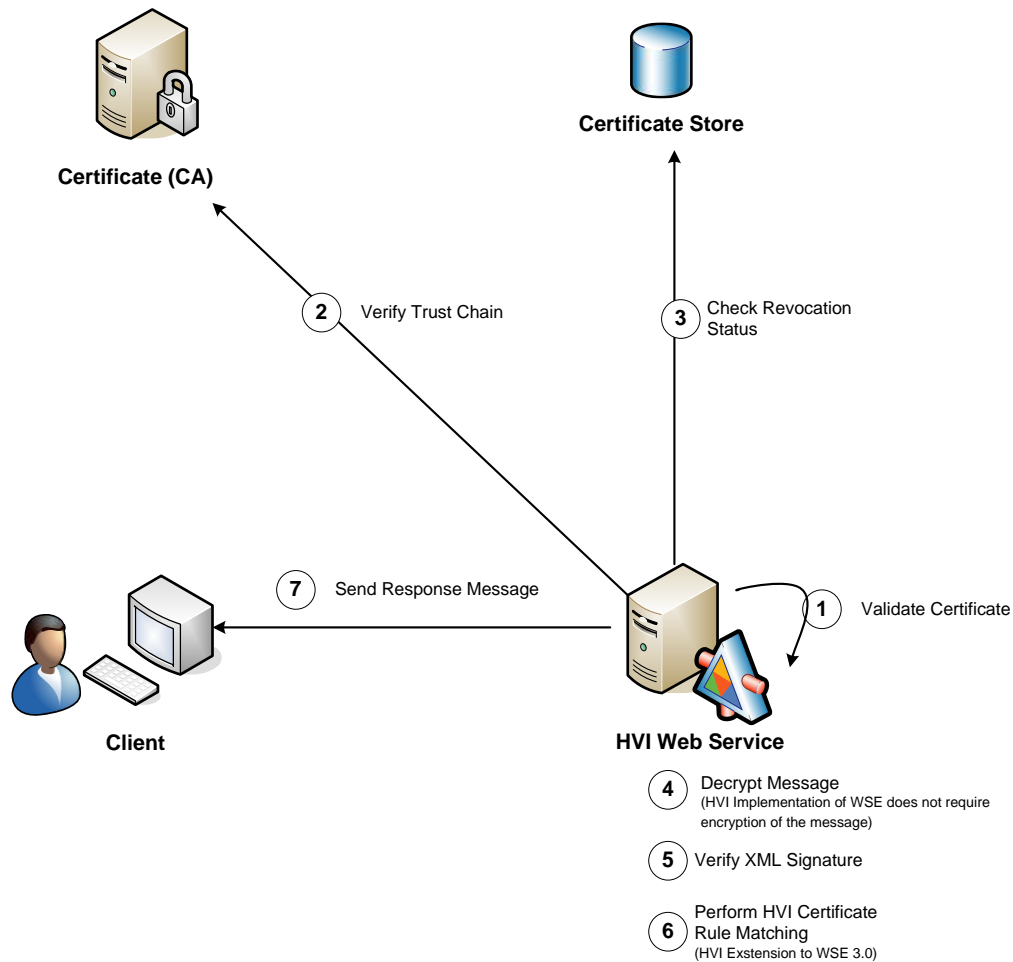

1. The service validates the client's certificate.
2. The service verifies the certificate trust chain. Authority (CA)
3. The service checks the certificate revocation status.
4. The service decrypts the message. (HVI Implementation does not require encryption so this is not performed)
5. The service verifies the signature.

6. The service performs HVI Certificate Rule Matching
7. The service initializes and sends a response to the client.

Step One: The Service Validates the Client's Certificate

WSE 3.0 validates the client's certificate attached to the request message. The certificate's validity period is checked to ensure that the service does not process a request that was secured with an expired X.509 certificate.

WSE 3.0 also verifies the integrity of the certificate's contents to ensure that it has not been tampered with after the certificate authority (CA) issued it. The integrity of the certificate's contents is verified using the signature of the issuing CA, which is also included in the certificate. If the certificate's contents cannot be validated against the issuer's signature, then the certificate has been tampered with and it is rejected as invalid.

Step Two: The Service Verifies the Certificate Trust Chain

By default, WSE 3.0 verifies the trust chain of certificates, or requires that the client's certificate is installed in the Trusted People folder in the service's local certificate store. WSE 3.0 must be able to recognize an issuing CA as trusted to verify the certificate trust chain for the client's X.509 certificate. WSE 3.0 recognizes an issuing CA as trusted based on the X.509 certificate that endorses the client's certificate. WSE 3.0 recognizes the issuing CA's certificate as a trusted root for a certificate chain if the CA's X.509 certificate is installed in the machine certificate store in the Trusted Root Certification Authorities folder.

In the HVI Configuration the client's certificate must be installed in the Trusted People Folder.

Step Three: The Service Checks the Certificate Revocation Status

WSE 3.0 policy checks the revocation status of the certificate by verifying whether the certificate is on a certificate revocation list (CRL) that the CA publishes.

Step Four: The Service Decrypts the Message

By default, the mutualCertificate10Security assertion protects the message body by encrypting it. When WSE 3.0 receives an encrypted message, WSE 3.0 policy automatically decrypts it using the following steps:

1. WSE determines the value to identify the service's certificate either the RFC3280 Subject Key Identifier, or the issuer name and serial number that the client included in the message tells the service which certificate was used to encrypt the message. WSE 3.0 policy uses this value to determine which private key it must use to decrypt the message.
2. WSE decrypts the asymmetrically encrypted, one-time symmetric key that the client sent with the message, using the service's private key
3. WSE uses the symmetric key to decrypt the message data using a symmetric algorithm. By default, WSE 3.0 uses AES 256 for symmetric encryption.

Note: service side policy alone does not stop a client from sending an unencrypted message. However, the policy will reject a message at the server if it is not encrypted.

The HVI does not require encrypted messages and does not encrypt message bodies.

Step Five: The Service Verifies the Signature

WSE 3.0 verifies the client's signature on the incoming request message using the public key sent with the message. If the message data is signed, this step also validates the client as the message originator to provide data origin authentication.

Step Six: The Service Performs HVI Certificate Matching

The out of the box WSE3.0 functionality has been extended to enable verification of XML received by the HVI service from participants.

The additional verification step will verify that the SenderOrgId specified within the XML message received matches the OrgId of the client certificate. This verification is known as Certificate Rule Matching.

- The Sender Org Id Is retrieved from the XML Message
- The Certificate Rules for the sender Org Id are retrieved from the HVI Service Web.config file
- The CerificateRuleCheck class will compare the Clients Certificate retrieved in the request with the Certificate Rules from the web config
- If there are any matches found the client will be verified and the XML message will be processed. If not a Soap Exception will be raised with the message "Certificate Rule Failure. No valid matching certificate rules identified."

4. Message Submission and Retrieval

The Web Service conforms to the SOAP 1.2 protocol and is defined by the Web Services Definition Language (WSDL) file in Appendix A. The SOAP definition can be found at <http://www.w3.org/TR/soap/>. The XML messages exchanged via the CMA Web Service must be valid SOAP messages and the **soap:Body** must contain one Document element conforming to the schema.

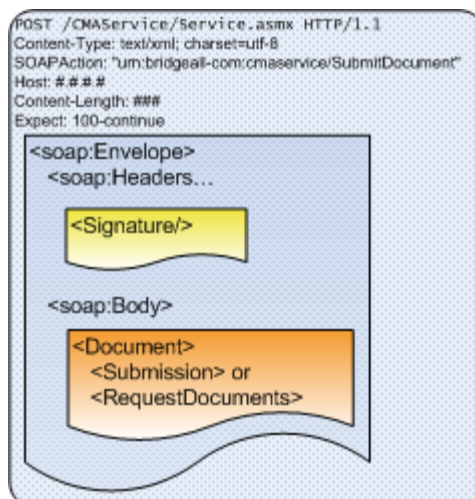
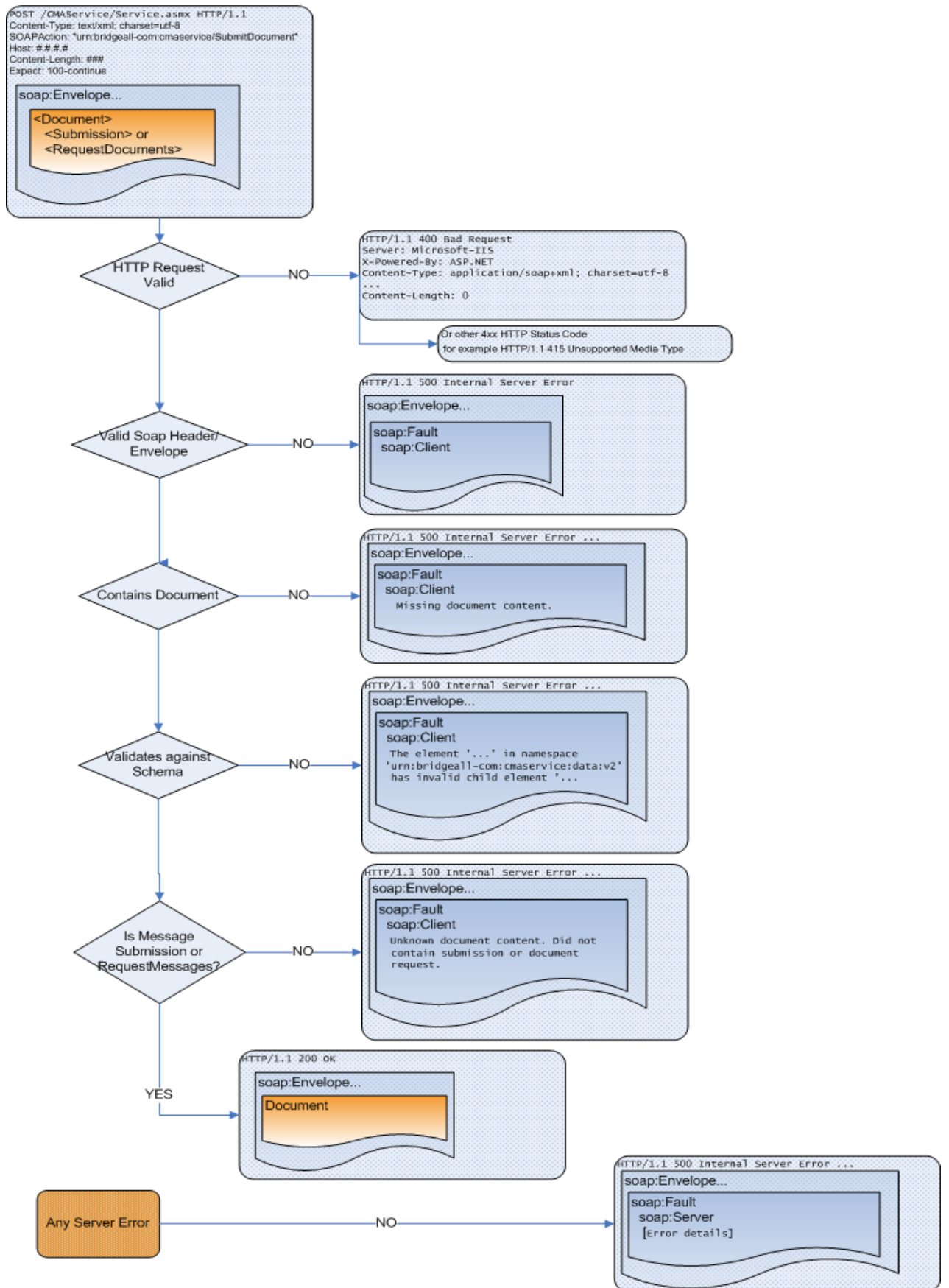

Figure 1 - Example participant submission over HTTP

The figure on the next page details the validation that the CMA Central Systems carry out on all document submissions over the XML interface. Firstly the request is checked to ensure it is a valid HTTP request. If not, a HTTP error is returned with a standard HTTP 4.xx error code indicating what the issue was. If the HTTP request is valid then the SOAP message tags are examined and verified. Only when a valid SOAP message has been received with a Document in the SOAP Body that contains either a Submission or a RequestMessages tag will the message be processed. See the diagram below for detail on the error handling.



4.1 High level view of message exchange

The Document element can have one of four valid children Submission, RequestMessages, Response or Handshakes.

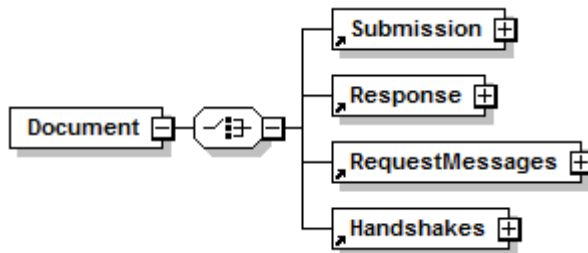

Figure 2 - Structure of all CMA XML Documents

All messages submitted to the CMA will receive an immediate synchronous response to confirm the message has been received.

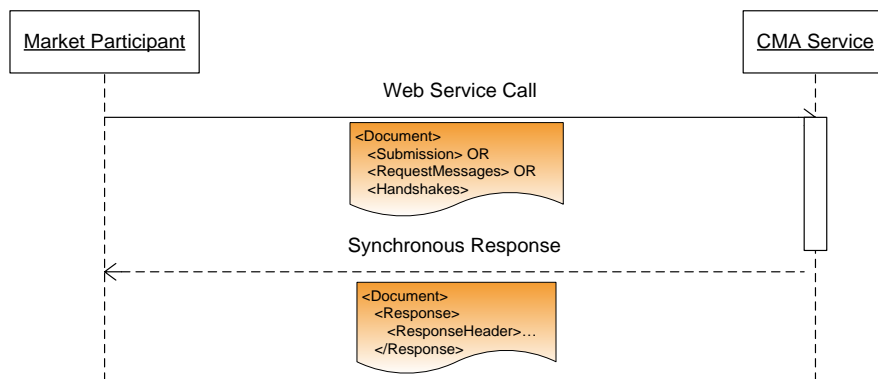
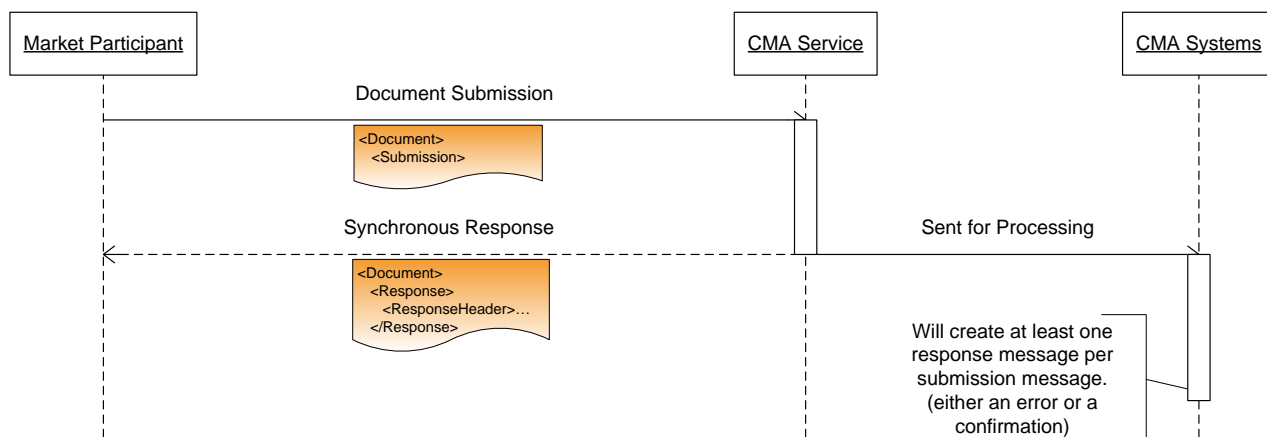

Figure 3 - Basic Submission with synchronous response

There will be a further asynchronous response at a later time when the CMA processes the message contents.



For example if a Licensed Participant called **ANLP** wished to submit a T012.1 to inform the CMA of an update to a service element they would generate their own unique message ID and populate the MID with this unique id and create a Submission element, wrap it in the SOAP 1.2 envelope (SOAP tags not shown below) and post it to the CMA web service.

<Submission

```

xmlns:xsi=http://www.w3.org/2001/XMLSchema-instance
xmlns:xsd="http://www.w3.org/2001/XMLSchema"
xmlns="urn:bridgeall-com:cmaservice:data:v3">
  
```

<Header>

```

<D1005_SenderOrgId>ANLP</D1005_SenderOrgId>
<D1006_RecipientOrgId>CMA</D1006_RecipientOrgId>
<D1007_TransactionTimestamp>2008-08-02T14:04:46</D1007_TransactionTimestamp>
<D1003_FlowReference />
  
```

</Header>

<Messages>

```

<T012.1_ServiceElementUpdates>
  <T012.1_ServiceElementUpdate MID="ANLP00100000586">
    <D2001_SPID>200000070103</D2001_SPID>
    <D2018_TroughsDrinkingBowls>2</D2018_TroughsDrinkingBowls>
    <D4006_EffectiveFrom>2008-05-02</D4006_EffectiveFrom>
    <D4003_Comment>Added two troughs</D4003_Comment>
  </T012.1_ServiceElementUpdate>
</T012.1_ServiceElementUpdates>
  
```

</Messages>

</Submission>

If the request is well formed and valid, the CMA will respond synchronously to this submission with a ResponseHeader as shown below. A unique flow reference is generated and issued by the CMA (D1003_FlowReference) which may be used in the future to identify the submission.

<Response

```

xmlns:xsi="http://www.w3.org/2001/XMLSchema-instance"
xmlns:xsd="http://www.w3.org/2001/XMLSchema"
xmlns="urn:bridgeall-com:cmaservice:data:v3">
<ResponseHeader>
  <D1005_SenderOrgId>CMA</D1005_SenderOrgId>
  <D1006_RecipientOrgId>ANLP</D1006_RecipientOrgId>
  <D1007_TransactionTimestamp>2008-08-02T14:04:47</D1007_TransactionTimestamp>
  <D1003_FlowReference>cd07ee64-de17-4d3f-a0b3-4bf6918ddf72</D1003_FlowReference>
  <
</ResponseHeader>
</Response>

```

This immediate synchronous response is acknowledgement that the CMA received the submission and that it was well formed and valid XML according to the schema. The Central Systems will then process the data in the request and within 24 hours an asynchronous message will be generated by the CMA in response to the submission. To receive these responses the participant must poll the Central Systems periodically to receive them. In order to do this a RequestMessages element must be sent specifying how many response messages the participant would like to receive. The example below requests just one response message at a time.

```

<cma:Document
  xsi:schemaLocation="urn:bridgeall-com:cmaservice:data:v3 CMADData_V3.xsd"
  xmlns:xsi="http://www.w3.org/2001/XMLSchema-instance"
  xmlns:cma="urn:bridgeall-com:cmaservice:data:v3">
  <cma:RequestMessages D1005_SenderOrgID="ANLP">
    <cma:NewMessages MaxMessages="1"/>
  </cma:RequestMessages>
</cma:Document>

```

The CMA will send back a T009.0 asynchronous response to the original message with either an OK if the message was processed successfully by the Central Systems or an error code if there were any issues processing the information. The related MID should be used by the participant to correlate this response with the original message sent by the participant.

```

<ResponseMessages
  xmlns:xsi="http://www.w3.org/2001/XMLSchema-instance"
  xmlns:xsd="http://www.w3.org/2001/XMLSchema"
  xmlns="urn:bridgeall-com:cmaservice:data:v3">
  <T009.0_Notification MID="CMA000000000347" RelatedMID="ANLP00100000586">
    <D1008_DataItemRef>D2001_SPID</D1008_DataItemRef>
    <D4004_ReturnCode>OK</D4004_ReturnCode>
  </T009.0_Notification>
</ResponseMessages>

```

It should be noted that the Related MID will only be populated by the CMA when it is generated in response to a message sent by that LP. Unsolicited messages created by the CMA to inform and LP of an event, such as the outgoing LP being informed of a registration being cancelled, will not have a Related MID populated. The error transaction from the LP to the CMA is the only instance where the LP would have to populate the Related MID.

In summary, response messages can be classified as either a SOAP level or application level response. All valid messages will receive a synchronous SOAP level response. If the HTTP Request is valid and the SOAP envelope is valid and the message contains a valid document which contains a <Submission> element, then a synchronous response will be received containing a <ResponseHeader> element. There will be a further application level asynchronous response within one business day as the message is processed by the Central Systems. This is the response that has to be pulled from the CMA by sending a <RequestMessages> element to the CMA. If there are messages waiting for the participant then <ResponseMessages> will be returned and may contain the MID from any original message as the Related MID.

In order for the LP to confirm the message batch has been successfully received, a HandShake document type should be sent to the CMA service containing the D1003_FlowReference GUID value as detailed in the following example:

```
<?xml version="1.0" encoding="utf-8"?>
<Document xmlns:xsi="http://www.w3.org/2001/XMLSchema-instance"
xmlns:xsd="http://www.w3.org/2001/XMLSchema" xmlns="urn:bridgeall-
com:cmaservice:data:v3">
  <HandShakes D1005_SenderOrgID="SWBS">
    <HandShake D1003_FlowReference="b2a78b32-d273-4db5-a222-ecd14857c104" />
    <HandShake D1003_FlowReference="9272daf3-f3b9-4811-9b6f-110c2ae69204" />
    <HandShake D1003_FlowReference="238cbef2-ec8d-486d-837c-81f671424cae" />
    <HandShake D1003_FlowReference="8dd35617-fc0f-40ba-9439-d8272ad5a294"
MessageCount="1000" />
    <HandShake D1003_FlowReference="50bdb6dc-7aed-4392-bf3e-ff3ae90efe73"
MessageCount="10" XMLDocLength="3456" />
  </HandShakes>
</Document>
```

4.2 CMA Messages in detail

The web service operates in an asynchronous manner and is designed to implement long running transactions for the message/response sequences. A Document submitted to the CMA for processing can contain many messages. Each message sent to the CMA and sent back from the CMA must contain a globally unique ID referred to as the Message ID or 'MID'. The Message ID is 16 digits long, the first 6 of which must start with the participants market ID and the seventh should be a '0'. For licensed provider 'PARTIC' an example of valid Message IDs could be PARTIC0000000001, PARTIC0000000002 and PARTIC0999999999. If a message is submitted to the CMA with a duplicate ID it will not be processed.

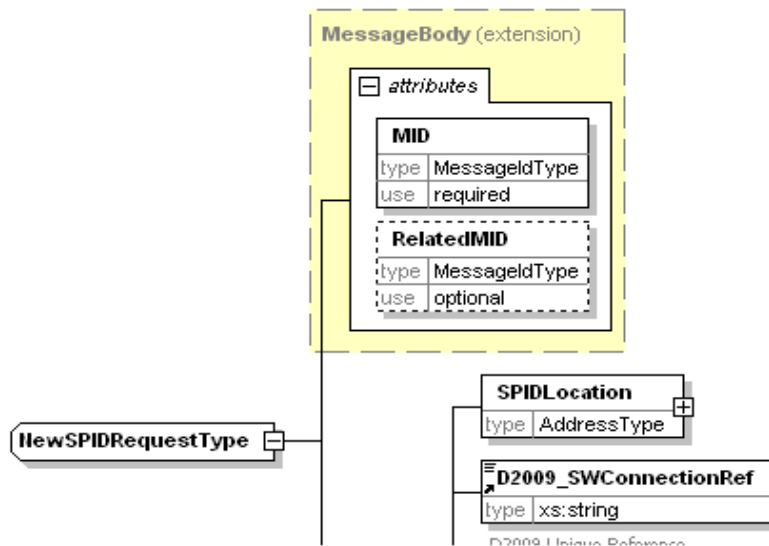

Figure 4 Schema showing the MID and RelatedMID attributes

When the CMA generates messages in response to an incoming message and replies to the original participant the **RelatedMID** field will be populated with the incoming messages original **MID**.

For example, if PARTIC submits message PARTIC0000000001, the CMA will send back a confirmation (or error) when the message has been processed which will have a new MID (CMA0000000000000) and with RelatedMID= PARTIC0000000001.

4.3 Submission of document

A document Submission must consist of valid Header and Messages elements as shown in the schema diagram below.

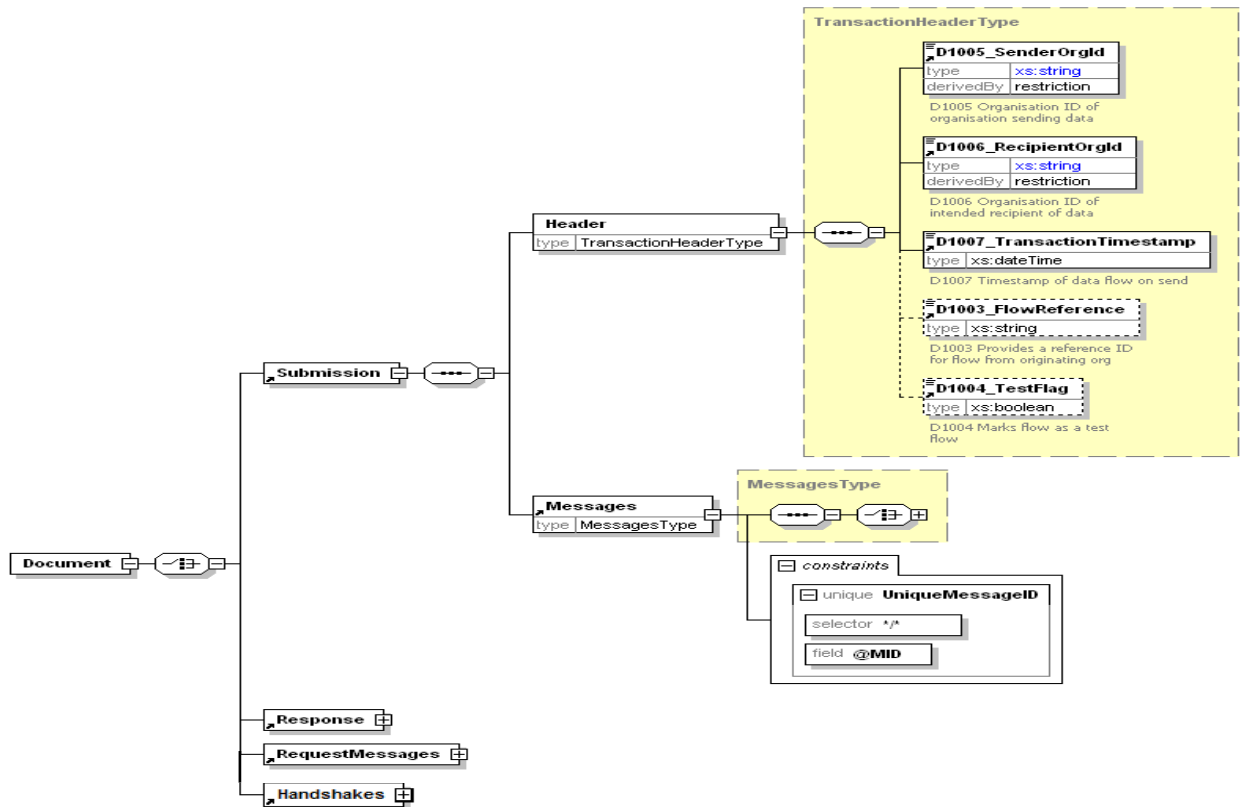

4.4 Requesting New Messages

In order to request response messages from the CMA a participant must submit a RequestMessages element and include the maximum number of messages that they wish to receive. The messages returned will be new messages and any messages that the participant has asked to be reissued.

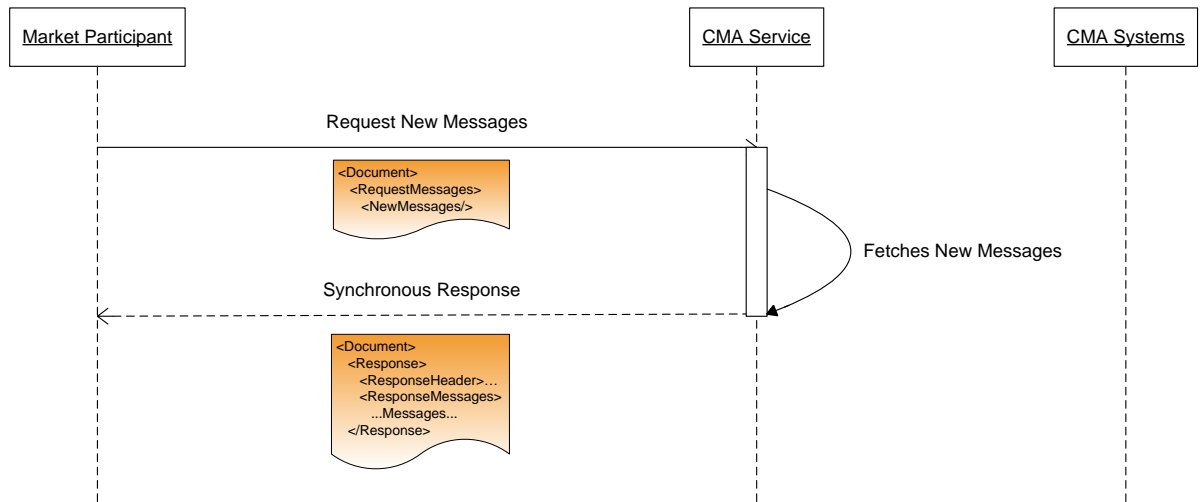

4.5 Handling Optional Data

If a field is designated as optional in the schema it should not be included in a message if it is not to be updated. If it is included in the message the CMA will update the value stored in the Central Systems. If for instance a Boolean is optional and an empty tag is sent, this would be invalid XML. In the case of fields which are strings (text) an empty tag will be interpreted as an empty string and that value overwritten in the Central Systems database with an empty string.

Addresses are treated differently. If the Address is specified then Central Systems will overwrite the entire address with the data supplied, so if there are missing tags those fields would be interpreted as null fields and overwritten in the Central Systems database. This avoids possible errors occurring by merging partial address information.

Appendix A – Web Services Definition Language (WSDL)

The latest current version may be obtained from the CMA in .wsdl (text) file format. The text below is for reference only and should not be copied from this document.

```
<?xml version="1.0" encoding="utf-8"?>
<wsdl:definitions xmlns:soap="http://schemas.xmlsoap.org/wsdl/soap/"
xmlns:tm="http://microsoft.com/wsdl/mime/textMatching/"
xmlns:soapenc="http://schemas.xmlsoap.org/soap/encoding/"
xmlns:mime="http://schemas.xmlsoap.org/wsdl/mime/" xmlns:tns="urn:bridgeall-
com:cmaservice" xmlns:i0="urn:bridgeall-com:cmaservice:data:v3"
xmlns:s="http://www.w3.org/2001/XMLSchema"
xmlns:soap12="http://schemas.xmlsoap.org/wsdl/soap12/"
xmlns:http="http://schemas.xmlsoap.org/wsdl/http/" targetNamespace="urn:bridgeall-
com:cmaservice" xmlns:wsdl="http://schemas.xmlsoap.org/wsdl/"
  <wsdl:import namespace="urn:bridgeall-com:cmaservice:data:v3"
location="XML\CMAData_V3.xsd" />
  <wsdl:types>
    <s:schema elementFormDefault="qualified" targetNamespace="urn:bridgeall-
com:cmaservice">
      <s:import schemaLocation="XML\CMAData_V3.xsd" namespace="urn:bridgeall-
com:cmaservice:data:v3" />
      <s:element name="SubmitDocument">
        <s:complexType>
          <s:sequence>
            <s:element minOccurs="0" maxOccurs="1" ref="i0:Document" />
          </s:sequence>
        </s:complexType>
      </s:element>
      <s:element name="SubmitDocumentResponse">
        <s:complexType>
          <s:sequence>
            <s:element minOccurs="0" maxOccurs="1" ref="i0:Document" />
          </s:sequence>
        </s:complexType>
      </s:element>
    </s:schema>
  </wsdl:types>
  <wsdl:message name="SubmitDocumentSoapIn">
    <wsdl:part name="parameters" element="tns:SubmitDocument" />
  </wsdl:message>
  <wsdl:message name="SubmitDocumentSoapOut">
    <wsdl:part name="parameters" element="tns:SubmitDocumentResponse" />
  </wsdl:message>
  <wsdl:portType name="ServiceSoap">
    <wsdl:operation name="SubmitDocument">
      <wsdl:input message="tns:SubmitDocumentSoapIn" />
      <wsdl:output message="tns:SubmitDocumentSoapOut" />
    </wsdl:operation>
  </wsdl:portType>
  <wsdl:binding name="ServiceSoap" type="tns:ServiceSoap">
    <soap:binding transport="http://schemas.xmlsoap.org/soap/http" />
    <wsdl:operation name="SubmitDocument">
      <soap:operation soapAction="urn:bridgeall-com:cmaservice/SubmitDocument"
style="document" />
      <wsdl:input>
        <soap:body use="literal" />
      </wsdl:input>
      <wsdl:output>
        <soap:body use="literal" />
      </wsdl:output>
    </wsdl:operation>
  </wsdl:binding>
  <wsdl:binding name="ServiceSoap12" type="tns:ServiceSoap">
    <soap12:binding transport="http://schemas.xmlsoap.org/soap/http" />
    <wsdl:operation name="SubmitDocument">
      <soap12:operation soapAction="urn:bridgeall-com:cmaservice/SubmitDocument"
style="document" />
      <wsdl:input>
```

```
<soap12:body use="literal" />
</wsdl:input>
<wsdl:output>
  <soap12:body use="literal" />
</wsdl:output>
</wsdl:operation>
</wsdl:binding>
<wsdl:service name="Service">
  <wsdl:port name="ServiceSoap" binding="tns:ServiceSoap">
    <soap:address location="http://localhost:12357/Service.asmx" />
  </wsdl:port>
  <wsdl:port name="ServiceSoap12" binding="tns:ServiceSoap12">
    <soap12:address location="http://localhost:12357/Service.asmx" />
  </wsdl:port>
</wsdl:service>
</wsdl:definitions>
```

Appendix B – XML Schema Documentation

The latest current version may be obtained from the CMA in .xsd (text) file format. The documentation below is for version [V3] of the schema.

Elements

[D1003 FlowReference](#)
[D1005 SenderOrgId](#)
[D1006 RecipientOrgId](#)

[D1007 TransactionTimestamp](#)

[D1008 DataItemRef](#)
[D1009 DuplicateMessageID](#)
[D2001 SPID](#)

[D2002 ServiceCategory](#)
[D2003 Schedule3](#)
[D2004 ExemptCustomerFlag](#)

[D2005 CustomerClassification](#)
[D2006 29e](#)
[D2007 LargeVoIAgreement](#)
[D2008 SICCode](#)
[D2009 SWConnectionRef](#)
[D2010 YVe](#)
[D2011 RateableValue](#)
[D2012 SurfaceArea](#)

[D2013 ConnectionDate](#)
[D2014 FarmCroft](#)
[D2015 SPIDVacant](#)

[D2016 PropertyDrainage](#)

[D2017 RoadDrainage](#)
[D2018 TroughsDrinkingBowls](#)
[D2020 OutsideTaps](#)

[D2023 NewConnectionType](#)
[D2024 Unmeasurable](#)
[D2025 DisconnectionReconnection](#)
[D2027 CustomerName](#)
[D2028 CustomerNameType](#)
[D2029 MeteredBuildingWater](#)
[D2030 MeteredBuildingWaterEffectiveDate](#)
[D2031 VacancyChangeFlag](#)
[D2032 LPChallengedVacancyApplicationFlag](#)
[D2033 AccreditedEntityInstall](#)

[D2034 AllocationMethod](#)
[D2035 MainSPID](#)
[D2036 SubSPID](#)

[D2041 PcentExemption](#)
[D2042 LiveRateableValue](#)
[D2043 LPConnectionRef](#)

Complex types

[AddressType](#)
[CancelRegistrationNotificationOutType](#)
[CancelRegistrationNotificationType](#)

[CancelRegistrationOutType](#)

[CancelRegistrationType](#)
[ChargeableMeterUpdateType](#)
[ConnectionCompleteType](#)

[CustomerNameUpdatedNotificationType](#)
[DisconnectionType](#)
[DiscontinueDPIDType](#)

[DPIDNotificationType](#)
[DPIDUpdateType](#)
[DPMeterReadType](#)
[LPMeterUpdateType](#)
[MessageBody](#)
[MessagesType](#)
[MeterAssociationType](#)
[MeterDisAssociationType](#)

[MeterNetworkAssociationType](#)
[MeterReadNotificationType](#)
[MeterReadType](#)

[MeterSWAPDetailsNotificationType](#)

[MeterSWAPDetailsType](#)
[MeterSwapNotificationType](#)
[MeterSwapType](#)

[MeterUpdateNotificationType](#)
[MeterUpdateType](#)

[NewLPSPIDNotificationType](#)

[NewSPIDNotificationType](#)

[NewSPIDRequestType](#)

[NotificationType](#)

[NotifyRSSType](#)

[PartialRegistrationApplicationType](#)

[PostcodeType](#)

[PremisesSpecialArrangementsUpdateNotificationType](#)
[PremisesSpecialArrangementsUpdateType](#)

[RegistrationStartType](#)

[ResponseMessagesType](#)

[Schedule3UpdateType](#)

[ServiceElementUpdateNotificationType](#)

[SewerageServiceElementUpdateNotificationType](#)

Simple types

[AllocationMethodType](#)
[CancellationCodeType](#)
[CryptographicHashAlgorithm](#)
[CustomerClassificationType](#)
[CustomerNameType](#)
[decimal18](#)
[DisconnectionReconnectionType](#)
[FarmCroftType](#)
[MessageIDType](#)
[MeterLocationCodeType](#)
[MeterTreatmentType](#)
[NewConnectionType](#)
[percentage](#)
[ReadFrequencyType](#)
[ReadType](#)
[ReturnCodeType](#)
[ServiceCategoryType](#)
[SReadReasonCodeType](#)
[string32](#)
[TETreatmentType](#)
[UARNAbsenceCodeType](#)
[UPRNAbsenceCodeType](#)

| | |
|---------------------------------------------------|-----------------------------------------------------------------------------------|
| D3001 MeterId | SewerageSPIDDataType |
| D3002 ChargeableMeterSize | SpecialArrangementsUpdateNotificationType |
| D3003 PhysicalMeterSize | SpecialArrangementsUpdateType |
| D3004 NrDigits | T003.1 RegistrationApplicationType |
| D3005 SewerageChargeableMeterSize | T004.0 NewMeterType |
| D3006 SubMeterId | T004.1 NewMeterNotificationType |
| D3007 ReturnToSewerAllowance | T004.3 VirtualMeterType |
| D3008 MeterRead | T006.0 LPWaterSPIDUpdateType |
| D3009 MeterReadDate | T006.1 LPSewerageSPIDUpdateType |
| D3010 MeterReadType | T006.2 WaterSPIDUpdateType |
| D3011 MeterReadFrequency | T006.3 SewerageSPIDUpdateType |
| D3012 ReRead | T006.4 WaterSPIDNotificationType |
| D3013 MeterMake | T006.5 SewerageSPIDNotificationType |
| D3014 ManufacturerMeterSerialNr | T006.6 ProvideLiveRateableValueType |
| D3015 datalogger_SW | T006.7 ProvideLiveRateableValueNotificationType |
| D3016 datalogger_NonSW | T007.0 WaterConnectionCompleteType |
| D3017 GISX | T009.4 NotificationType |
| D3018 GISY | T012.0 MiscSPIDUpdateType |
| D3019 GISZFreeDescriptor | T012.1 ServiceElementUpdateType |
| D3020 Rollover_Indicator | T012.3 SewerageServiceElementUpdateType |
| D3021 Rollover_Flag | T012.7 UpdateLiveRateableValueType |
| D3022 MeterTreatment | T012.8 UpdateLiveRateableValueNotificationType |
| D3023 AccreditedEntityInstall | T016.0 UnmeasurableDeclarationType |
| D3024 MDVol | T032.0 CreateUpdateCustomerNameType |
| D3025 MeterLocationCode | T032.1 CustomerNameUpdatedType |
| D3026 MeterNetworkAssociation | T033.0 MeteredBuilding |
| D3027 MainMeterId | T033.1 MeteredBuildingUpdate |
| D3028 SReadReasonCode | T034.0 VacSchemeApplication |
| D3029 SReadRemedialWorkIndicator | T034.1 VacSchemeGracePeriodNotification |
| D4001 OrgId | T034.2 VacSchemeGraceEndNotification |
| D4002 RegistrationStartDate | T034.3 VacSchemeApplicationNotification |
| D4003 Comment | T034.4 VacSchemeApplicationConfirmationOrCancellation |
| D4004 ReturnCode | T034.5 VacSchemeApplicationConfirmationOrCancellationNotification |
| D4005 CancellationCode | T035.0 TradeabilityNotification |
| D4006 EffectiveFrom | T035.1 TradeabilityNotification |
| D4007 DateOfEvidence | TEUpdateType |
| D4008 CryptographicHash | TransactionHeaderType |
| D4009 CryptographicHashAlgorithm | UARNTType |
| D4010 VacancyChangeGracePeriod | UpdateMeterLocationNotificationType |
| D4011 WaterSPLPOrgId | UpdateMeterLocationType |
| D4012 SewerageSPLPOrgId | UpdateSAAReferenceNumberUPRNNotificationType |
| D5001 FreeDescriptor | UpdateSAAReferenceNumberUPRNType |
| D6001 DPID | UPRNType |
| D6002 TEYVe | WaterSPIDDataType |
| D6003 CDV | |
| D6004 sBODL | |

[D6005 TSSL](#)

[D6006 Ot](#)

[D6007 St](#)

[D6009 Non-domesticAllowance](#)

[D6010 SDTIndicator](#)

[D6011 TETreatment](#)

[D6012 PcentAllowance](#)

[D6013 FixedAllowance](#)

[Document](#)

[Handshakes](#)

[Messages](#)

[RequestMessages](#)

[Response](#)

[ResponseMessages](#)

[Submission](#)

element D1003_FlowReference

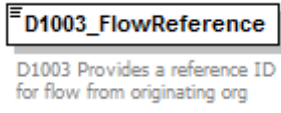
| diagram |  <p>D1003 Provides a reference ID for flow from originating org</p> | | | | | | | | | |
|------------|---------------------------------------------------------------------------------------------------------------------------------------------------------------------------------------------------------------------------------------------------------------------------------------------------------------------------------------------------------------------------------------------------------------------------------------------------------------------------|------------|-------|------------|-----------|---|--|---------|--------------------------|--|
| namespace | urn:bridgeall-com:cmaservice:data:v3 | | | | | | | | | |
| type | restriction of xs:string | | | | | | | | | |
| properties | content simple | | | | | | | | | |
| used by | complexType TransactionHeaderType | | | | | | | | | |
| facets | <table><thead><tr><th>Kind</th><th>Value</th><th>annotation</th></tr></thead><tbody><tr><td>minLength</td><td>1</td><td></td></tr><tr><td>pattern</td><td>([a-z][A-Z][0-9][\-_])*</td><td></td></tr></tbody></table> | Kind | Value | annotation | minLength | 1 | | pattern | ([a-z][A-Z][0-9][\-_])* | |
| Kind | Value | annotation | | | | | | | | |
| minLength | 1 | | | | | | | | | |
| pattern | ([a-z][A-Z][0-9][\-_])* | | | | | | | | | |
| annotation | documentation D1003 Provides a reference ID for flow from originating org | | | | | | | | | |
| source | <pre><xs:element name="D1003_FlowReference"> <xs:annotation> <xs:documentation>D1003 Provides a reference ID for flow from originating org</xs:documentation> </xs:annotation> <xs:simpleType> <xs:restriction base="xs:string"> <xs:minLength value="1"/> <xs:pattern value="([a-z][A-Z][0-9][\-_])*" /> </xs:restriction> </xs:simpleType> </xs:element></pre> | | | | | | | | | |

element D1005_SenderOrgId

| | |
|---------|-----------------------------------------------------------------------------------------------------------------------------------------------|
| diagram |  <p>D1005 Organisation ID of organisation sending data</p> |
|---------|-----------------------------------------------------------------------------------------------------------------------------------------------|

| namespace | urn:bridgeall-com:cmaservice:data:v3 | | | | | | | | | | | | |
|------------|------------------------------------------------------------------------------------------------------------------------------------------------------------------------------------------------------------------------------------------------------------------------------------------------------------------------------------------------------------------------------------------------------------------------------------------------------------------------------------------------------|------------|-------|------------|-----------|---|--|-----------|---|--|---------|--------------------------|--|
| type | restriction of xs:string | | | | | | | | | | | | |
| properties | content simple | | | | | | | | | | | | |
| used by | complexType TransactionHeaderType | | | | | | | | | | | | |
| facets | <table border="1"> <thead> <tr> <th>Kind</th> <th>Value</th> <th>annotation</th> </tr> </thead> <tbody> <tr> <td>minLength</td> <td>1</td> <td></td> </tr> <tr> <td>maxLength</td> <td>6</td> <td></td> </tr> <tr> <td>pattern</td> <td colspan="2">([a-z][A-Z][0-9][\-\-])*</td> </tr> </tbody> </table> | Kind | Value | annotation | minLength | 1 | | maxLength | 6 | | pattern | ([a-z][A-Z][0-9][\-\-])* | |
| Kind | Value | annotation | | | | | | | | | | | |
| minLength | 1 | | | | | | | | | | | | |
| maxLength | 6 | | | | | | | | | | | | |
| pattern | ([a-z][A-Z][0-9][\-\-])* | | | | | | | | | | | | |
| annotation | documentation D1005 Organisation ID of organisation sending data | | | | | | | | | | | | |
| source | <pre><xs:element name="D1005_SenderOrgId"> <xs:annotation> <xs:documentation>D1005 Organisation ID of organisation sending data</xs:documentation> </xs:annotation> <xs:simpleType> <xs:restriction base="xs:string"> <xs:minLength value="1"/> <xs:maxLength value="6"/> <xs:pattern value="([a-z][A-Z][0-9][\-\-])*" /> </xs:restriction> </xs:simpleType> </xs:element></pre> | | | | | | | | | | | | |

element **D1006_RecipientOrgId**

| diagram |  | | | | | | | | | | | | |
|------------|----------------------------------------------------------------------------------------------------------------------------------------------------------------------------------------------------------------------------------------------------------------------------------------------------------------------------------------------------------------------------------------------------------------------------------------------------------------------------------------------------------|------------|-------|------------|-----------|---|--|-----------|---|--|---------|--------------------------|--|
| namespace | urn:bridgeall-com:cmaservice:data:v3 | | | | | | | | | | | | |
| type | restriction of xs:string | | | | | | | | | | | | |
| properties | content simple | | | | | | | | | | | | |
| used by | complexType TransactionHeaderType | | | | | | | | | | | | |
| facets | <table border="1"> <thead> <tr> <th>Kind</th> <th>Value</th> <th>annotation</th> </tr> </thead> <tbody> <tr> <td>minLength</td> <td>1</td> <td></td> </tr> <tr> <td>maxLength</td> <td>6</td> <td></td> </tr> <tr> <td>pattern</td> <td colspan="2">([a-z][A-Z][0-9][\-\-])*</td> </tr> </tbody> </table> | Kind | Value | annotation | minLength | 1 | | maxLength | 6 | | pattern | ([a-z][A-Z][0-9][\-\-])* | |
| Kind | Value | annotation | | | | | | | | | | | |
| minLength | 1 | | | | | | | | | | | | |
| maxLength | 6 | | | | | | | | | | | | |
| pattern | ([a-z][A-Z][0-9][\-\-])* | | | | | | | | | | | | |
| annotation | documentation D1006 Organisation ID of intended recipient of data | | | | | | | | | | | | |
| source | <pre><xs:element name="D1006_RecipientOrgId"> <xs:annotation> <xs:documentation>D1006 Organisation ID of intended recipient of data</xs:documentation> </xs:annotation> <xs:simpleType> <xs:restriction base="xs:string"> <xs:minLength value="1"/> <xs:maxLength value="6"/> <xs:pattern value="([a-z][A-Z][0-9][\-\-])*" /> </xs:restriction> </xs:simpleType> </xs:element></pre> | | | | | | | | | | | | |

element D1007_TransactionTimestamp

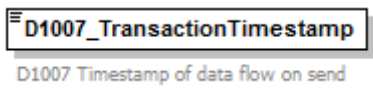
| | |
|------------|-------------------------------------------------------------------------------------------------------------------------------------------------------------------------------------------------------------------------------------------------------|
| diagram |  |
| namespace | urn:bridgeall-com:cmaservice:data:v3 |
| type | xs:dateTime |
| properties | content simple |
| used by | complexType TransactionHeaderType |
| annotation | documentation D1007 Timestamp of data flow on send |
| source | <pre><xs:element name="D1007_TransactionTimestamp" type="xs:dateTime"> <xs:annotation> <xs:documentation>D1007 Timestamp of data flow on send</xs:documentation> </xs:annotation> </xs:element></pre> |

element D1008_DataItemRef

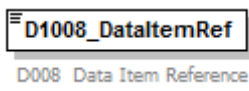
| | |
|------------|----------------------------------------------------------------------------------------------------------------------------------------------------------------------------------------------------------------------------|
| diagram |  |
| namespace | urn:bridgeall-com:cmaservice:data:v3 |
| type | xs:string |
| properties | content simple |
| used by | complexType NotificationType |
| annotation | documentation D008 Data Item Reference |
| source | <pre><xs:element name="D1008_DataItemRef" type="xs:string"> <xs:annotation> <xs:documentation>D008 Data Item Reference</xs:documentation> </xs:annotation> </xs:element></pre> |

element D1009_DuplicateMessageID

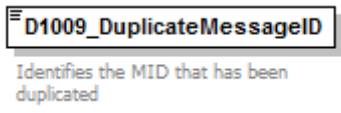
| | |
|------------|-------------------------------------------------------------------------------------|
| diagram |  |
| namespace | urn:bridgeall-com:cmaservice:data:v3 |
| type | xs:string |
| properties | content simple |
| used by | complexType T009.4 NotificationType |
| annotation | documentation Identifies the MID that has been duplicated |
| source | <pre><xs:element name="D1009_DuplicateMessageID" type="xs:string"></pre> |

| | |
|--|------------------------------------------------------------------------------------------------------------------------------------------------------------------------------|
| | <pre> <xs:annotation> <xs:documentation>Identifies the MID that has been duplicated</xs:documentation> </xs:annotation> </xs:element> </pre> |
|--|------------------------------------------------------------------------------------------------------------------------------------------------------------------------------|

element **D2001_SPID**

| diagram |  | | | | | | | | | | | | |
|------------|----------------------------------------------------------------------------------------------------------------------------------------------------------------------------------------------------------------------------------------------------------------------------------------------------------------------------------------------------------------------------------------------------------------------------------------------------------------------------------------------------------------------------------------------------------------------------------------------------------------------------------------------------------------------------------------------------------------------------------------------------------------------------------------------------------------------------------------------------------------------------------------------------------------------------------------------------------------------------------------------------------------------------------------------------------------------------------------------------------------------------------------------------------------------------------------------------------------------------------------------------------------------------------------------------------------------------------------------------------------------------------------------------------------------------------------------------------------------------------------------------------------------------------------------------------------------------------------------------------------------------------------------------------------------------------------------------------------------------------------------------------------------------------------------------------------------------------------------------------------------------------------------------------------------------------------------------------------------------------------------------------------------------------------------------------------------------------------------------------------------------------------------------------------------------------------------------------------------------------------------------------------------------------------------------------------------------------------------------------------------------------------------------------------------------------------------------------------------------------------------------------------------------------------------------------------------------------------------------------------------------------------------------------------------------------------------------------------------------------------------------------------------------------------------------------------------------------------------------------------------------------------------------------------------------------------------------------------------------------------------------------------------------------------------------------------------------------------------------------------------------------------------------------------------------------------------------------------------------------------------------------------------------------------------------------------------------------------------------------------------------------------------------------------------------------------------------------------|------------|-------|------------|-----------|----|--|-----------|----|--|---------|----------|--|
| namespace | urn:bridgeall-com:cmaservice:data:v3 | | | | | | | | | | | | |
| type | restriction of xs:string | | | | | | | | | | | | |
| properties | content simple | | | | | | | | | | | | |
| used by | <p>complexType</p> <p> CancelRegistrationNotificationOutType CancelRegistrationNotificationType CancelRegistrationType ChargeableMeterUpdateType ConnectionCompleteType CustomerNameUpdatedNotificationType DisconnectionType DiscontinueDPIDType DPIDNotificationType DPIDUpdateType DPMeterReadType LPMeterUpdateType MeterAssociationType MeterDisAssociationType MeterReadNotificationType MeterReadType MeterSwapNotificationType MeterSwapType MeterUpdateNotificationType MeterUpdateType NewLPSPIDNotificationType NewSPIDNotificationType NewSPIDRequestType NotificationType NotifyRSDType PartialRegistrationApplicationType PremisesSpecialArrangementsUpdateNotificationType PremisesSpecialArrangementsUpdateType RegistrationStartType Schedule3UpdateType ServiceElementUpdateNotificationType SewerageServiceElementUpdateNotificationType SewerageSPIDDataType SpecialArrangementsUpdateNotificationType SpecialArrangementsUpdateType T003.1_RegistrationApplicationType T004.0_NewMeterType T004.1_NewMeterNotificationType T004.3_VirtualMeterType T006.0_LPWaterSPIDUpdateType T006.1_LPSewerageSPIDUpdateType T006.2_WaterSPIDUpdateType T006.3_SewerageSPIDUpdateType T006.4_WaterSPIDNotificationType T006.5_SewerageSPIDNotificationType T006.6_ProvideLiveRateableValueType T006.7_ProvideLiveRateableValueNotificationType T007.0_WaterConnectionCompleteType T012.0_MiscSPIDUpdateType T012.1_ServiceElementUpdateType T012.3_SewerageServiceElementUpdateType T012.7_UpdateLiveRateableValueType T012.8_UpdateLiveRateableValueNotificationType T016.0_UnmeasureableDeclarationType T032.0_CreateUpdateCustomerNameType T032.1_CustomerNameUpdatedType T033.0_MeteredBuilding T033.1_MeteredBuildingUpdate T034.0_VacSchemeApplication T034.1_VacSchemeGracePeriodNotification T034.2_VacSchemeGraceEndNotification T034.3_VacSchemeApplicationNotification T034.4_VacSchemeApplicationConfirmationOrCancellation T034.5_VacSchemeApplicationConfirmationOrCancellationNotification T035.0_TradeabilityNotification T035.1_TradeabilityNotification TEUpdateType UpdateMeterLocationNotificationType UpdateMeterLocationType UpdateSAARefereceNumberUPRNNotificationType UpdateSAARefereceNumberUPRNTType WaterSPIDDataType </p> | | | | | | | | | | | | |
| facets | <table border="1"> <thead> <tr> <th>Kind</th> <th>Value</th> <th>annotation</th> </tr> </thead> <tbody> <tr> <td>minLength</td> <td>12</td> <td></td> </tr> <tr> <td>maxLength</td> <td>12</td> <td></td> </tr> <tr> <td>pattern</td> <td>([0-9])*</td> <td></td> </tr> </tbody> </table> | Kind | Value | annotation | minLength | 12 | | maxLength | 12 | | pattern | ([0-9])* | |
| Kind | Value | annotation | | | | | | | | | | | |
| minLength | 12 | | | | | | | | | | | | |
| maxLength | 12 | | | | | | | | | | | | |
| pattern | ([0-9])* | | | | | | | | | | | | |
| annotation | <p>documentation</p> <p>D2001 Unique identifier that Identifies each supply point and the service provided</p> | | | | | | | | | | | | |

| | |
|--------|-------------------------------------------------------------------------------------------------------------------------------------------------------------------------------------------------------------------------------------------------------------------------------------------------------------------------------------------------------------------------------------------------------------------------------------------------------------------------------------------------------------------|
| source | <pre> <xs:element name="D2001_SPID"> <xs:annotation> <xs:documentation>D2001 Unique identifier that Identifies each supply point and the service provided </xs:documentation> </xs:annotation> <xs:simpleType> <xs:restriction base="xs:string"> <xs:maxLength value="12"/> <xs:minLength value="12"/> <xs:pattern value="([0-9])*"/> </xs:restriction> </xs:simpleType> </xs:element> </pre> |
|--------|-------------------------------------------------------------------------------------------------------------------------------------------------------------------------------------------------------------------------------------------------------------------------------------------------------------------------------------------------------------------------------------------------------------------------------------------------------------------------------------------------------------------|

element **D2002_ServiceCategory**

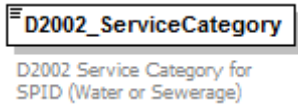
| diagram |  | | | | | | | | | |
|-------------|--------------------------------------------------------------------------------------------------------------------------------------------------------------------------------------------------------------------------------------------------------------------------|------------|-------|------------|-------------|----|--|-------------|----|--|
| namespace | urn:bridgeall-com:cmaservice:data:v3 | | | | | | | | | |
| type | ServiceCategoryType | | | | | | | | | |
| properties | content simple | | | | | | | | | |
| facets | <table border="1"> <thead> <tr> <th>Kind</th> <th>Value</th> <th>annotation</th> </tr> </thead> <tbody> <tr> <td>enumeration</td> <td>01</td> <td></td> </tr> <tr> <td>enumeration</td> <td>02</td> <td></td> </tr> </tbody> </table> | Kind | Value | annotation | enumeration | 01 | | enumeration | 02 | |
| Kind | Value | annotation | | | | | | | | |
| enumeration | 01 | | | | | | | | | |
| enumeration | 02 | | | | | | | | | |
| annotation | documentation D2002 Service Category for SPID (Water or Sewerage) | | | | | | | | | |
| source | <pre> <xs:element name="D2002_ServiceCategory" type="ServiceCategoryType"> <xs:annotation> <xs:documentation>D2002 Service Category for SPID (Water or Sewerage) </xs:documentation> </xs:annotation> </xs:element> </pre> | | | | | | | | | |

element **D2003_Schedule3**

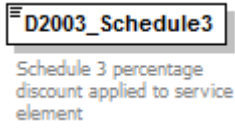
| diagram |  | | | | | | | | | | | | | | | |
|----------------|------------------------------------------------------------------------------------------------------------------------------------------------------------------------------------------------------------------------------------------------------------------------------------------------------------------------------------------------------|------------|-------|------------|--------------|---|--|--------------|-----|--|-------------|---|--|----------------|---|--|
| namespace | urn:bridgeall-com:cmaservice:data:v3 | | | | | | | | | | | | | | | |
| type | percentage | | | | | | | | | | | | | | | |
| properties | content simple | | | | | | | | | | | | | | | |
| used by | complexTypes Schedule3UpdateType SpecialArrangementsUpdateNotificationType SpecialArrangementsUpdateType | | | | | | | | | | | | | | | |
| facets | <table border="1"> <thead> <tr> <th>Kind</th> <th>Value</th> <th>annotation</th> </tr> </thead> <tbody> <tr> <td>minInclusive</td> <td>0</td> <td></td> </tr> <tr> <td>maxInclusive</td> <td>100</td> <td></td> </tr> <tr> <td>totalDigits</td> <td>5</td> <td></td> </tr> <tr> <td>fractionDigits</td> <td>2</td> <td></td> </tr> </tbody> </table> | Kind | Value | annotation | minInclusive | 0 | | maxInclusive | 100 | | totalDigits | 5 | | fractionDigits | 2 | |
| Kind | Value | annotation | | | | | | | | | | | | | | |
| minInclusive | 0 | | | | | | | | | | | | | | | |
| maxInclusive | 100 | | | | | | | | | | | | | | | |
| totalDigits | 5 | | | | | | | | | | | | | | | |
| fractionDigits | 2 | | | | | | | | | | | | | | | |
| annotation | documentation Schedule 3 percentage discount applied to service element | | | | | | | | | | | | | | | |

| | |
|--------|------------------------------------------------------------------------------------------------------------------------------------------------------------------------------------------------------------------------------------------------------------|
| source | <pre><xs:element name="D2003_Schedule3" type="percentage"> <xs:annotation> <xs:documentation>Schedule 3 percentage discount applied to service element</xs:documentation> </xs:annotation> </xs:element></pre> |
|--------|------------------------------------------------------------------------------------------------------------------------------------------------------------------------------------------------------------------------------------------------------------|

element D2004_ ExemptCustomerFlag

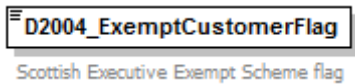
| | |
|------------|--------------------------------------------------------------------------------------------------------------------------------------------------------------------------------------------------------------------------------------------------|
| diagram |  |
| namespace | urn:bridgeall-com:cmaservice:data:v3 |
| type | xs:boolean |
| properties | content simple |
| used by | complexTypes PremisesSpecialArrangementsUpdateNotificationType PremisesSpecialArrangementsUpdateType SpecialArrangementsUpdateNotificationType |
| annotation | documentation Scottish Executive Exempt Scheme flag |
| source | <pre><xs:element name="D2004_ ExemptCustomerFlag" type="xs:boolean"> <xs:annotation> <xs:documentation>Scottish Executive Exempt Scheme flag</xs:documentation> </xs:annotation> </xs:element></pre> |

element D2005_ CustomerClassification

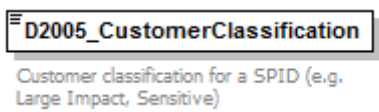
| | | | | | | | | | | | | | | | | | |
|------------|--------------------------------------------------------------------------------------------------------------------------------------------------------------------------------------------------------------------------------------------------------------------------------------------------|-------|-------------|-------|------------|--|--|-----|--|--|--|-----|--|--|--|----|--|
| diagram |  | | | | | | | | | | | | | | | | |
| namespace | urn:bridgeall-com:cmaservice:data:v3 | | | | | | | | | | | | | | | | |
| type | CustomerClassificationType | | | | | | | | | | | | | | | | |
| properties | content simple | | | | | | | | | | | | | | | | |
| used by | complexTypes SewerageSPIDDataType T006.0_LPWaterSPIDUpdateType T006.1_LPsewerageSPIDUpdateType T012.0_MiscSPIDUpdateType WaterSPIDDataType | | | | | | | | | | | | | | | | |
| facets | <table border="0"> <tr> <td>Kind</td> <td>enumeration</td> <td>Value</td> <td>annotation</td> </tr> <tr> <td></td> <td></td> <td>LIC</td> <td></td> </tr> <tr> <td></td> <td></td> <td>SST</td> <td></td> </tr> <tr> <td></td> <td></td> <td>NA</td> <td></td> </tr> </table> | Kind | enumeration | Value | annotation | | | LIC | | | | SST | | | | NA | |
| Kind | enumeration | Value | annotation | | | | | | | | | | | | | | |
| | | LIC | | | | | | | | | | | | | | | |
| | | SST | | | | | | | | | | | | | | | |
| | | NA | | | | | | | | | | | | | | | |
| annotation | documentation Customer classification for a SPID (e.g. Large Impact, Sensitive) | | | | | | | | | | | | | | | | |
| source | <pre><xs:element name="D2005_ CustomerClassification" type="CustomerClassificationType"> <xs:annotation> <xs:documentation>Customer classification for a SPID (e.g. Large Impact, Sensitive)</xs:documentation> </xs:annotation> </xs:element></pre> | | | | | | | | | | | | | | | | |

element D2006_29e

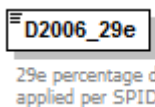
| | |
|------------|-----------------------------------------------------------------------------------------------------------------------------------------------------------------------------------------------------------------------------------------|
| diagram |  |
| namespace | urn:bridgeall-com:cmaservice:data:v3 |
| type | percentage |
| properties | content simple |
| used by | complexTypees SpecialArrangementsUpdateNotificationType SpecialArrangementsUpdateType |
| facets | Kind Value annotation minInclusive 0 maxInclusive 100 totalDigits 5 fractionDigits 2 |
| annotation | documentation 29e percentage discount applied per SPID |
| source | <pre><xs:element name="D2006_29e" type="percentage"> <xs:annotation> <xs:documentation>29e percentage discount applied per SPID</xs:documentation> </xs:annotation> </xs:element></pre> |

element D2007_LargeVolAgreement

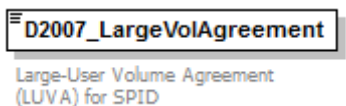
| | |
|------------|----------------------------------------------------------------------------------------------------------------------------------------------------------------------------------------------------------------------------------------------------------|
| diagram |  |
| namespace | urn:bridgeall-com:cmaservice:data:v3 |
| type | xs:boolean |
| properties | content simple |
| used by | complexTypees SpecialArrangementsUpdateNotificationType SpecialArrangementsUpdateType |
| annotation | documentation Large-User Volume Agreement (LUVA) for SPID |
| source | <pre><xs:element name="D2007_LargeVolAgreement" type="xs:boolean"> <xs:annotation> <xs:documentation>Large-User Volume Agreement (LUVA) for SPID</xs:documentation> </xs:annotation> </xs:element></pre> |

element D2008_SICCode

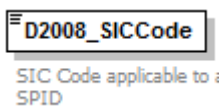
| | |
|-----------|-------------------------------------------------------------------------------------|
| diagram |  |
| namespace | urn:bridgeall-com:cmaservice:data:v3 |

| type | restriction of xs:string | | | | | | | | | |
|------------|--------------------------------------------------------------------------------------------------------------------------------------------------------------------------------------------------------------------------------------------------------------------------------------------------------------------------------------------------------------------------------------------------------------------------------|------------|-------|------------|-----------|----|--|---------|--------------------|--|
| properties | content simple | | | | | | | | | |
| used by | complexTypes SewerageSPIDDataType T006.0 LPWaterSPIDUpdateType T006.1 LPsewerageSPIDUpdateType T012.0 MiscSPIDUpdateType WaterSPIDDataType | | | | | | | | | |
| facets | <table border="1"> <thead> <tr> <th>Kind</th> <th>Value</th> <th>annotation</th> </tr> </thead> <tbody> <tr> <td>maxLength</td> <td>16</td> <td></td> </tr> <tr> <td>pattern</td> <td>([a-z][A-Z][0-9])*</td> <td></td> </tr> </tbody> </table> | Kind | Value | annotation | maxLength | 16 | | pattern | ([a-z][A-Z][0-9])* | |
| Kind | Value | annotation | | | | | | | | |
| maxLength | 16 | | | | | | | | | |
| pattern | ([a-z][A-Z][0-9])* | | | | | | | | | |
| annotation | documentation SIC Code applicable to a SPID | | | | | | | | | |
| source | <pre><xs:element name="D2008_SICCode"> <xs:annotation> <xs:documentation>SIC Code applicable to a SPID</xs:documentation> </xs:annotation> <xs:simpleType> <xs:restriction base="xs:string"> <xs:maxLength value="16"/> <xs:pattern value="([a-z][A-Z][0-9])*/> </xs:restriction> </xs:simpleType> </xs:element></pre> | | | | | | | | | |

element **D2009_SWConnectionRef**

| diagram |  | | | | | | | | | |
|------------|----------------------------------------------------------------------------------------------------------------------------------------------------------------------------------------------------------------------------------------------------------------------------------------------------------------------------------------------------------------------------------------------------------------------------------------------------------------------------------------------------|------------|-------|------------|-----------|----|--|---------|------------------------|--|
| namespace | urn:bridgeall-com:cmaservice:data:v3 | | | | | | | | | |
| type | restriction of xs:string | | | | | | | | | |
| properties | content simple | | | | | | | | | |
| used by | complexTypes NewLPSPIDNotificationType NewSPIDNotificationType NewSPIDRequestType | | | | | | | | | |
| facets | <table border="1"> <thead> <tr> <th>Kind</th> <th>Value</th> <th>annotation</th> </tr> </thead> <tbody> <tr> <td>maxLength</td> <td>32</td> <td></td> </tr> <tr> <td>pattern</td> <td>([a-z][A-Z][0-9][\V])*</td> <td></td> </tr> </tbody> </table> | Kind | Value | annotation | maxLength | 32 | | pattern | ([a-z][A-Z][0-9][\V])* | |
| Kind | Value | annotation | | | | | | | | |
| maxLength | 32 | | | | | | | | | |
| pattern | ([a-z][A-Z][0-9][\V])* | | | | | | | | | |
| annotation | documentation D2009 Unique Reference wholesaler uses to identify new connections under installation | | | | | | | | | |
| source | <pre><xs:element name="D2009_SWConnectionRef"> <xs:annotation> <xs:documentation>D2009 Unique Reference wholesaler uses to identify new connections under installation</xs:documentation> </xs:annotation> <xs:simpleType> <xs:restriction base="xs:string"> <xs:maxLength value="32"/> <xs:pattern value="([a-z][A-Z][0-9][\V])*/> </xs:restriction> </xs:simpleType> </xs:element></pre> | | | | | | | | | |

element **D2010_YVe**

| | | | | | | | | | | |
|--------------|---------------------------------------------------------------------------------------------------------------------------------------------------------------------------------------------------------------------------------------------------------------------------------------------------------------------------------------------------------------------------------------------------------------------------------------------------|------------|-------|------------|--------------|---|--|--------------|--------------|--|
| diagram |  | | | | | | | | | |
| namespace | urn:bridgeall-com:cmaservice:data:v3 | | | | | | | | | |
| type | restriction of xs:decimal | | | | | | | | | |
| properties | content simple | | | | | | | | | |
| used by | complexTypes LPMeterUpdateType T004.1 NewMeterNotificationType T004.3 VirtualMeterType | | | | | | | | | |
| facets | <table border="0"> <tr> <td>Kind</td> <td>Value</td> <td>annotation</td> </tr> <tr> <td>minInclusive</td> <td>0</td> <td></td> </tr> <tr> <td>maxInclusive</td> <td>999999999999</td> <td></td> </tr> </table> | Kind | Value | annotation | minInclusive | 0 | | maxInclusive | 999999999999 | |
| Kind | Value | annotation | | | | | | | | |
| minInclusive | 0 | | | | | | | | | |
| maxInclusive | 999999999999 | | | | | | | | | |
| annotation | documentation Yearly Volumetric Usage Estimate for the SPID | | | | | | | | | |
| source | <pre><xs:element name="D2010_YVe"> <xs:annotation> <xs:documentation>Yearly Volumetric Usage Estimate for the SPID</xs:documentation> </xs:annotation> <xs:simpleType> <xs:restriction base="xs:decimal"> <xs:minInclusive value="0"/> <xs:maxInclusive value="999999999999"/> </xs:restriction> </xs:simpleType> </xs:element></pre> | | | | | | | | | |

element **D2011_RateableValue**

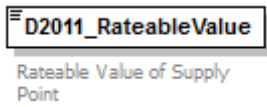
| | | | | | | | | | | | | | | | | |
|----------------|--------------------------------------------------------------------------------------------------------------------------------------------------------------------------------------------------------------------------------------------------------------------------------------------------------------------------------------------------------------------------------------|------------|-------|------------|--------------|---|--|--------------|---------------|--|-------------|----|--|----------------|---|--|
| diagram |  | | | | | | | | | | | | | | | |
| namespace | urn:bridgeall-com:cmaservice:data:v3 | | | | | | | | | | | | | | | |
| type | restriction of xs:decimal | | | | | | | | | | | | | | | |
| properties | content simple | | | | | | | | | | | | | | | |
| used by | complexTypes SewerageSPIDDataType T006.0 LPWaterSPIDUpdateType T006.1 LPWaterSPIDUpdateType T006.4 WaterSPIDNotificationType T006.5 SewerageSPIDNotificationType T012.1 ServiceElementUpdateType WaterSPIDDataType | | | | | | | | | | | | | | | |
| facets | <table border="0"> <tr> <td>Kind</td> <td>Value</td> <td>annotation</td> </tr> <tr> <td>minInclusive</td> <td>0</td> <td></td> </tr> <tr> <td>maxInclusive</td> <td>2000000000.99</td> <td></td> </tr> <tr> <td>totalDigits</td> <td>12</td> <td></td> </tr> <tr> <td>fractionDigits</td> <td>2</td> <td></td> </tr> </table> | Kind | Value | annotation | minInclusive | 0 | | maxInclusive | 2000000000.99 | | totalDigits | 12 | | fractionDigits | 2 | |
| Kind | Value | annotation | | | | | | | | | | | | | | |
| minInclusive | 0 | | | | | | | | | | | | | | | |
| maxInclusive | 2000000000.99 | | | | | | | | | | | | | | | |
| totalDigits | 12 | | | | | | | | | | | | | | | |
| fractionDigits | 2 | | | | | | | | | | | | | | | |
| annotation | documentation Rateable Value of Supply Point | | | | | | | | | | | | | | | |
| source | <pre><xs:element name="D2011_RateableValue"> <xs:annotation> <xs:documentation>Rateable Value of Supply Point</xs:documentation> </xs:annotation> <xs:simpleType> <xs:restriction base="xs:decimal"> <xs:totalDigits value="12"/> </xs:restriction> </xs:simpleType> </xs:element></pre> | | | | | | | | | | | | | | | |

| | |
|--|--------------------------------------------------------------------------------------------------------------------------------------------------------------------------------------------------------|
| | <pre> <xs:fractionDigits value="2"/> <xs:minInclusive value="0"/> <xs:maxInclusive value="2000000000.99"/> </xs:restriction> </xs:simpleType> </xs:element> </pre> |
|--|--------------------------------------------------------------------------------------------------------------------------------------------------------------------------------------------------------|

element D2012_SurfaceArea

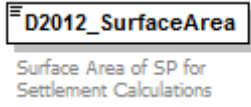
| diagram |  | | | | | | | | | | | | | | | |
|----------------|---------------------------------------------------------------------------------------------------------------------------------------------------------------------------------------------------------------------------------------------------------------------------------------------------------------------------------------------------------------------------------------------------------------------------------------------------------------------------------------------------------------------------------------------------|------------|-------|------------|--------------|---|--|--------------|---------------|--|-------------|----|--|----------------|---|--|
| namespace | urn:bridgeall-com:cmaservice:data:v3 | | | | | | | | | | | | | | | |
| type | restriction of xs:decimal | | | | | | | | | | | | | | | |
| properties | content simple | | | | | | | | | | | | | | | |
| used by | complexType SewerageSPIDDataType | | | | | | | | | | | | | | | |
| facets | <table border="1"> <thead> <tr> <th>Kind</th> <th>Value</th> <th>annotation</th> </tr> </thead> <tbody> <tr> <td>minInclusive</td> <td>0</td> <td></td> </tr> <tr> <td>maxInclusive</td> <td>9999999999.99</td> <td></td> </tr> <tr> <td>totalDigits</td> <td>12</td> <td></td> </tr> <tr> <td>fractionDigits</td> <td>2</td> <td></td> </tr> </tbody> </table> | Kind | Value | annotation | minInclusive | 0 | | maxInclusive | 9999999999.99 | | totalDigits | 12 | | fractionDigits | 2 | |
| Kind | Value | annotation | | | | | | | | | | | | | | |
| minInclusive | 0 | | | | | | | | | | | | | | | |
| maxInclusive | 9999999999.99 | | | | | | | | | | | | | | | |
| totalDigits | 12 | | | | | | | | | | | | | | | |
| fractionDigits | 2 | | | | | | | | | | | | | | | |
| annotation | documentation Surface Area of SP for Settlement Calculations | | | | | | | | | | | | | | | |
| source | <pre> <xs:element name="D2012_SurfaceArea"> <xs:annotation> <xs:documentation>Surface Area of SP for Settlement Calculations</xs:documentation> </xs:annotation> <xs:simpleType> <xs:restriction base="xs:decimal"> <xs:totalDigits value="12"/> <xs:fractionDigits value="2"/> <xs:minInclusive value="0"/> <xs:maxInclusive value="9999999999.99"/> </xs:restriction> </xs:simpleType> </xs:element> </pre> | | | | | | | | | | | | | | | |

element D2013_ConnectionDate

| | |
|------------|--------------------------------------------------------------------------------------------------------------------------------------------------------------|
| diagram |  |
| namespace | urn:bridgeall-com:cmaservice:data:v3 |
| type | xs:date |
| properties | content simple |
| used by | complexType ConnectionCompleteType T007.0 WaterConnectionCompleteType T035.0 TradeabilityNotification T035.1 |
| annotation | documentation Date the connection was completed |
| source | <pre> <xs:element name="D2013_ConnectionDate" type="xs:date"> </pre> |

| | |
|--|------------------------------------------------------------------------------------------------------------------------------------------------------------------|
| | <pre><xs:annotation> <xs:documentation>Date the connection was completed</xs:documentation> </xs:annotation> </xs:element></pre> |
|--|------------------------------------------------------------------------------------------------------------------------------------------------------------------|

element D2014_FarmCroft

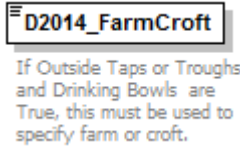
| diagram |  | | | | | | | | | | | | |
|-------------|-------------------------------------------------------------------------------------------------------------------------------------------------------------------------------------------------------------------------------------------------------------------------------------------------------------|------------|-------|------------|-------------|------|--|-------------|-------|--|-------------|----|--|
| namespace | urn:bridgeall-com:cmaservice:data:v3 | | | | | | | | | | | | |
| type | FarmCroftType | | | | | | | | | | | | |
| properties | content simple | | | | | | | | | | | | |
| used by | complexTypes T006.2 WaterSPIDUpdateType T006.4 WaterSPIDNotificationType T012.1 ServiceElementUpdateType WaterSPIDDataType | | | | | | | | | | | | |
| facets | <table border="1"> <thead> <tr> <th>Kind</th> <th>Value</th> <th>annotation</th> </tr> </thead> <tbody> <tr> <td>enumeration</td> <td>FARM</td> <td></td> </tr> <tr> <td>enumeration</td> <td>CROFT</td> <td></td> </tr> <tr> <td>enumeration</td> <td>NA</td> <td></td> </tr> </tbody> </table> | Kind | Value | annotation | enumeration | FARM | | enumeration | CROFT | | enumeration | NA | |
| Kind | Value | annotation | | | | | | | | | | | |
| enumeration | FARM | | | | | | | | | | | | |
| enumeration | CROFT | | | | | | | | | | | | |
| enumeration | NA | | | | | | | | | | | | |
| annotation | documentation If Outside Taps or Troughs and Drinking Bowls are True, this must be used to specify farm or croft. | | | | | | | | | | | | |
| source | <pre><xs:element name="D2014_FarmCroft" type="FarmCroftType"> <xs:annotation> <xs:documentation>If Outside Taps or Troughs and Drinking Bowls are True, this must be used to specify farm or croft.</xs:documentation> </xs:annotation> </xs:element></pre> | | | | | | | | | | | | |

element D2015_SPIDVacant

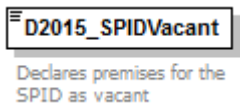
| | |
|------------|------------------------------------------------------------------------------------------------------------------------------------------------------------------------------------------------------------------------------------------------|
| diagram |  |
| namespace | urn:bridgeall-com:cmaservice:data:v3 |
| type | xs:boolean |
| properties | content simple |
| used by | complexTypes ServiceElementUpdateNotificationType T012.1 ServiceElementUpdateType |
| annotation | documentation Declares premises for the SPID as vacant |
| source | <pre><xs:element name="D2015_SPIDVacant" type="xs:boolean"> <xs:annotation> <xs:documentation>Declares premises for the SPID as vacant</xs:documentation> </xs:annotation> </xs:element></pre> |

element D2016_PropertyDrainage

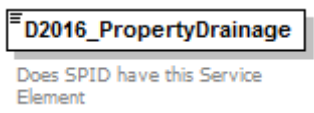
| | |
|------------|----------------------------------------------------------------------------------------------------------------------------------------------------------------------------------------------------------------------------------------------------------------------------------------------------------|
| diagram |  |
| namespace | urn:bridgeall-com:cmaservice:data:v3 |
| type | xs:boolean |
| properties | content simple |
| used by | complexTypes SewerageServiceElementUpdateNotificationType SewerageSPIDDataType T006.3 SewerageSPIDUpdateType T006.5 SewerageSPIDNotificationType T012.3 SewerageServiceElementUpdateType |
| annotation | documentation Does SPID have this Service Element |
| source | <pre><xs:element name="D2016_PropertyDrainage" type="xs:boolean"> <xs:annotation> <xs:documentation>Does SPID have this Service Element</xs:documentation> </xs:annotation> </xs:element></pre> |

element D2017_RoadDrainage

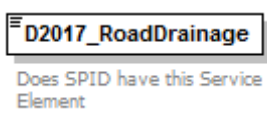
| | |
|------------|----------------------------------------------------------------------------------------------------------------------------------------------------------------------------------------------------------------------------------------------------------------------------------------------------------|
| diagram |  |
| namespace | urn:bridgeall-com:cmaservice:data:v3 |
| type | xs:boolean |
| properties | content simple |
| used by | complexTypes SewerageServiceElementUpdateNotificationType SewerageSPIDDataType T006.3 SewerageSPIDUpdateType T006.5 SewerageSPIDNotificationType T012.3 SewerageServiceElementUpdateType |
| annotation | documentation Does SPID have this Service Element |
| source | <pre><xs:element name="D2017_RoadDrainage" type="xs:boolean"> <xs:annotation> <xs:documentation>Does SPID have this Service Element</xs:documentation> </xs:annotation> </xs:element></pre> |

element D2018_TroughsDrinkingBowls

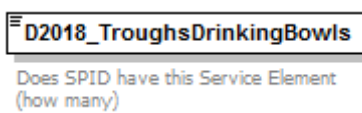
| | |
|------------|--------------------------------------------------------------------------------------------------------------------------------------------------------------------------------------------------------------------------------------------|
| diagram |  |
| namespace | urn:bridgeall-com:cmaservice:data:v3 |
| type | restriction of xs:short |
| properties | content simple |
| used by | complexTypes T006.2 WaterSPIDUpdateType T006.4 WaterSPIDNotificationType T012.1 ServiceElementUpdateType WaterSPIDDataType |
| facets | Kind Value annotation minInclusive 0 maxInclusive 999 |

| | |
|------------|--------------------------------------------------------------------------------------------------------------------------------------------------------------------------------------------------------------------------------------------------------------------------------------------------------------------------------------------------------------------------------------------------------------------------------------------------------|
| annotation | documentation Does SPID have this Service Element (how many) |
| source | <pre> <xs:element name="D2018_TroughsDrinkingBowls"> <xs:annotation> <xs:documentation>Does SPID have this Service Element (how many)</xs:documentation> </xs:annotation> <xs:simpleType> <xs:restriction base="xs:short"> <xs:minInclusive value="0"/> <xs:maxInclusive value="999"/> </xs:restriction> </xs:simpleType> </xs:element> </pre> |

element D2020_OutsideTaps

| diagram |  | | | | | | | | | |
|--------------|-----------------------------------------------------------------------------------------------------------------------------------------------------------------------------------------------------------------------------------------------------------------------------------------------------------------------------------------------------------------------------------------------------------------------------------------------|------------|-------|------------|--------------|---|--|--------------|-----|--|
| namespace | urn:bridgeall-com:cmaservice:data:v3 | | | | | | | | | |
| type | restriction of xs:short | | | | | | | | | |
| properties | content simple | | | | | | | | | |
| used by | complexTypes T006.2 WaterSPIDUpdateType T006.4 WaterSPIDNotificationType T012.1 ServiceElementUpdateType WaterSPIDDataType | | | | | | | | | |
| facets | <table border="1"> <thead> <tr> <th>Kind</th> <th>Value</th> <th>annotation</th> </tr> </thead> <tbody> <tr> <td>minInclusive</td> <td>0</td> <td></td> </tr> <tr> <td>maxInclusive</td> <td>999</td> <td></td> </tr> </tbody> </table> | Kind | Value | annotation | minInclusive | 0 | | maxInclusive | 999 | |
| Kind | Value | annotation | | | | | | | | |
| minInclusive | 0 | | | | | | | | | |
| maxInclusive | 999 | | | | | | | | | |
| annotation | documentation Does SPID have this Service Element (how many) | | | | | | | | | |
| source | <pre> <xs:element name="D2020_OutsideTaps"> <xs:annotation> <xs:documentation>Does SPID have this Service Element (how many)</xs:documentation> </xs:annotation> <xs:simpleType> <xs:restriction base="xs:short"> <xs:minInclusive value="0"/> <xs:maxInclusive value="999"/> </xs:restriction> </xs:simpleType> </xs:element> </pre> | | | | | | | | | |

element D2023_NewConnectionType

| | |
|------------|--------------------------------------------------------------------------------------------------------------------------------------|
| diagram |  |
| namespace | urn:bridgeall-com:cmaservice:data:v3 |
| type | NewConnectionType |
| properties | content simple |
| used by | complexTypes NewLPSPIDNotificationType NewSPIDNotificationType NewSPIDRequestType |

| | | | |
|--------|------------------------------------------------------------------------------------------------------------------------------------------------------------------------------------------|--------------|------------|
| facets | Kind enumeration | Value NEW | annotation |
| | enumeration | GS | |
| | enumeration | CU | |
| source | <pre><xs:element name="D2023_NewConnectionType" type="NewConnectionType"> <xs:annotation> <xs:documentation/> </xs:annotation> </xs:element></pre> | | |

element D2024_Unmeasurable

| | | | |
|------------|---------------------------------------------------------------------------------------------------------------------------------------------------------------------------------------------------------------|--------------------------------------------------------------------------------------|--|
| diagram |  | | |
| namespace | urn:bridgeall-com:cmaservice:data:v3 | | |
| type | xs:boolean | | |
| properties | content simple | | |
| used by | complexTypes | T016.0_UnmeasurableDeclarationType WaterSPIDDataType | |
| annotation | documentation | | |
| source | <pre><xs:element name="D2024_Unmeasurable" type="xs:boolean"> <xs:annotation> <xs:documentation> </xs:documentation> </xs:annotation> </xs:element></pre> | | |

element D2025_DisconnectionReconnection

| | | | |
|------------|----------------------------------------------------------------------------------------------------------------------------------------------------------------------------------------------------------------|-----------------------------------|------------|
| diagram |  | | |
| namespace | urn:bridgeall-com:cmaservice:data:v3 | | |
| type | DisconnectionReconnectionType | | |
| properties | content simple | | |
| used by | complexType | DisconnectionType | |
| facets | Kind enumeration | Value REC | annotation |
| | enumeration | TDISC | |
| | enumeration | PDISC | |
| | enumeration | DEREG | |
| source | <pre><xs:element name="D2025_DisconnectionReconnection" type="DisconnectionReconnectionType"> <xs:annotation> <xs:documentation/> </xs:annotation> </xs:element></pre> | | |

element **D2027_CustomerName**

| diagram |  | | | | | | | | | | | | |
|------------|--------------------------------------------------------------------------------------------------------------------------------------------------------------------------------------------------------------------------------------------------------------------------------------------------------------------------------------------------------------------------------------------------------------------------------------------------------------------------------------------------------|------------|-------|------------|-----------|---|--|-----------|-----|--|---------|--------------|--|
| namespace | urn:bridgeall-com:cmaservice:data:v3 | | | | | | | | | | | | |
| type | restriction of xs:string | | | | | | | | | | | | |
| properties | content simple | | | | | | | | | | | | |
| used by | complexTypes CustomerNameUpdatedNotificationType T032.0 CreateUpdateCustomerNameType T032.1 CustomerNameUpdatedType | | | | | | | | | | | | |
| facets | <table border="1"> <thead> <tr> <th>Kind</th> <th>Value</th> <th>annotation</th> </tr> </thead> <tbody> <tr> <td>minLength</td> <td>1</td> <td></td> </tr> <tr> <td>maxLength</td> <td>255</td> <td></td> </tr> <tr> <td>pattern</td> <td>([^\t\n\r])*</td> <td></td> </tr> </tbody> </table> | Kind | Value | annotation | minLength | 1 | | maxLength | 255 | | pattern | ([^\t\n\r])* | |
| Kind | Value | annotation | | | | | | | | | | | |
| minLength | 1 | | | | | | | | | | | | |
| maxLength | 255 | | | | | | | | | | | | |
| pattern | ([^\t\n\r])* | | | | | | | | | | | | |
| annotation | documentation D2027 Customer Name that owns a SPID | | | | | | | | | | | | |
| source | <pre> <xs:element name="D2027_CustomerName"> <xs:annotation> <xs:documentation>D2027 Customer Name that owns a SPID</xs:documentation> </xs:annotation> <xs:simpleType> <xs:restriction base="xs:string"> <xs:maxLength value="255"/> <xs:minLength value="1"/> <xs:pattern value="([^\t\n\r])*"/> </xs:restriction> </xs:simpleType> </xs:element> </pre> | | | | | | | | | | | | |

element **D2028_CustomerNameType**

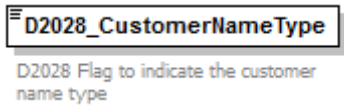
| diagram |  | | | | | | | | | |
|-------------|-------------------------------------------------------------------------------------------------------------------------------------------------------------------------------------------------------------------------------------------------------------------|------------|-------|------------|-------------|----------|--|-------------|-----------|--|
| namespace | urn:bridgeall-com:cmaservice:data:v3 | | | | | | | | | |
| type | CustomerNameType | | | | | | | | | |
| properties | content simple | | | | | | | | | |
| used by | complexTypes CustomerNameUpdatedNotificationType T032.0 CreateUpdateCustomerNameType T032.1 CustomerNameUpdatedType | | | | | | | | | |
| facets | <table border="1"> <thead> <tr> <th>Kind</th> <th>Value</th> <th>annotation</th> </tr> </thead> <tbody> <tr> <td>enumeration</td> <td>Customer</td> <td></td> </tr> <tr> <td>enumeration</td> <td>Developer</td> <td></td> </tr> </tbody> </table> | Kind | Value | annotation | enumeration | Customer | | enumeration | Developer | |
| Kind | Value | annotation | | | | | | | | |
| enumeration | Customer | | | | | | | | | |
| enumeration | Developer | | | | | | | | | |
| annotation | documentation D2028 Flag to indicate the customer name type | | | | | | | | | |
| source | <pre> <xs:element name="D2028_CustomerNameType" type="CustomerNameType"> <xs:annotation> <xs:documentation>D2028 Flag to indicate the customer name type</xs:documentation> </xs:annotation> </pre> | | | | | | | | | |

| | |
|--|---------------|
| | </xs:element> |
|--|---------------|

element D2029_MeteredBuildingWater

| | |
|------------|--------------------------------------------------------------------------------------------------------------------------------------------------------------------------------------------------------------------------------------------------------------------------------------------|
| diagram |  <p>D2029 Flag to indicate if the site is a metered building construction site</p> |
| namespace | urn:bridgeall-com:cmaservice:data:v3 |
| type | xs:boolean |
| properties | content simple |
| used by | complexTypes T033.0 MeteredBuilding T033.1 MeteredBuildingUpdate |
| annotation | documentation D2029 Flag to indicate if the site is a metered building construction site |
| source | <pre><xs:element name="D2029_MeteredBuildingWater" type="xs:boolean"> <xs:annotation> <xs:documentation>D2029 Flag to indicate if the site is a metered building construction site</xs:documentation> </xs:annotation> </xs:element></pre> |

element D2030_MeteredBuildingWaterEffectiveDate

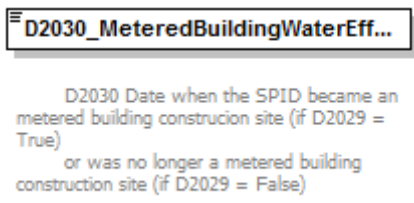
| | |
|------------|----------------------------------------------------------------------------------------------------------------------------------------------------------------------------------------------------------------------------------------------------------------------------------------------------------------------------------------------------------------------------------------------------------------|
| diagram |  <p>D2030 Date when the SPID became an metered building construction site (if D2029 = True) or was no longer a metered building construction site (if D2029 = False)</p> |
| namespace | urn:bridgeall-com:cmaservice:data:v3 |
| type | xs:date |
| properties | content simple |
| used by | complexTypes T033.0 MeteredBuilding T033.1 MeteredBuildingUpdate |
| annotation | documentation D2030 Date when the SPID became an metered building construction site (if D2029 = True) or was no longer a metered building construction site (if D2029 = False) |
| source | <pre><xs:element name="D2030_MeteredBuildingWaterEffectiveDate" type="xs:date"> <xs:annotation> <xs:documentation> D2030 Date when the SPID became an metered building construction site (if D2029 = True) or was no longer a metered building construction site (if D2029 = False) </xs:documentation> </xs:annotation> </xs:element></pre> |

element D2031_VacancyChangeFlag

| | |
|------------|--------------------------------------------------------------------------------------------------------------------------------------------------------------------------------------------------------------------------------------------------------------------------------------------------------------------------------------------------|
| diagram |  <p>Declares that a vacancy change application should proceed (if set to True), or should be cancelled (if set to False).</p> |
| namespace | urn:bridgeall-com:cmaservice:data:v3 |
| type | xs:boolean |
| properties | content simple |
| used by | complexTypes T034.4_VacSchemeApplicationConfirmationOrCancellation T034.5_VacSchemeApplicationConfirmationOrCancellationNotification |
| annotation | documentation Declares that a vacancy change application should proceed (if set to True), or should be cancelled (if set to False). |
| source | <pre><xs:element name="D2031_VacancyChangeFlag" type="xs:boolean"> <xs:annotation> <xs:documentation> Declares that a vacancy change application should proceed (if set to True), or should be cancelled (if set to False). </xs:documentation> </xs:annotation> </xs:element></pre> |

element D2032_LPChallengedVacancyApplicationFlag

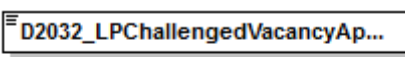
| | |
|------------|------------------------------------------------------------------------------------------------------------------------------------------------------------------------------------------------------------------------------------------------------------------------------------------------------------------------------------|
| diagram |  <p>Declares that an LP has raised a challenge against an SW vacancy change application.</p> |
| namespace | urn:bridgeall-com:cmaservice:data:v3 |
| type | xs:boolean |
| properties | content simple |
| used by | complexTypes T034.4_VacSchemeApplicationConfirmationOrCancellation T034.5_VacSchemeApplicationConfirmationOrCancellationNotification |
| annotation | documentation Declares that an LP has raised a challenge against an SW vacancy change application. |
| source | <pre><xs:element name="D2032_LPChallengedVacancyApplicationFlag" type="xs:boolean"> <xs:annotation> <xs:documentation> Declares that an LP has raised a challenge against an SW vacancy change application. </xs:documentation> </xs:annotation> </xs:element></pre> |

element D2033_AccreditedEntityInstall

| | |
|------------|------------------------------------------------------------------------------------------------------------------------------------------------------------------------------------------------------------------------------------------------------------------------------------------------------------------------------------------------------|
| diagram | |
| namespace | urn:bridgeall-com:cmaservice:data:v3 |
| type | xs:boolean |
| properties | content simple |
| used by | complexType T007.0_WaterConnectionCompleteType |
| annotation | documentation Accredited Entity Install - Allows Scottish Water to notify the CMA when an operation has been carried out by an accredited installer |
| source | <pre><xs:element name="D2033_AccreditedEntityInstall" type="xs:boolean"> <xs:annotation> <xs:documentation>Accredited Entity Install - Allows Scottish Water to notify the CMA when an operation has been carried out by an accredited installer</xs:documentation> </xs:annotation> </xs:element></pre> |

element D2034_AllocationMethod

| | | | | | | | | | | | | | | | | |
|------------|--------------------------------------------------------------------------------------------------------------------------------------------------------------------------------------------------------------------------------------------------------------------------------------------------|----------|-----------------|------------|-----------------|------------|--|-------------|----------|--|--|--|-------------|-----|--|--|
| diagram | | | | | | | | | | | | | | | | |
| namespace | urn:bridgeall-com:cmaservice:data:v3 | | | | | | | | | | | | | | | |
| type | AllocationMethodType | | | | | | | | | | | | | | | |
| properties | content simple | | | | | | | | | | | | | | | |
| used by | complexType NewLPSPIDNotificationType NewSPIDNotificationType | | | | | | | | | | | | | | | |
| facets | <table border="0"> <tr> <td>Kind</td> <td>enumeration</td> <td>Value</td> <td>Associated SPID</td> <td>annotation</td> </tr> <tr> <td></td> <td>enumeration</td> <td>Rotation</td> <td></td> <td></td> </tr> <tr> <td></td> <td>enumeration</td> <td>N/A</td> <td></td> <td></td> </tr> </table> | Kind | enumeration | Value | Associated SPID | annotation | | enumeration | Rotation | | | | enumeration | N/A | | |
| Kind | enumeration | Value | Associated SPID | annotation | | | | | | | | | | | | |
| | enumeration | Rotation | | | | | | | | | | | | | | |
| | enumeration | N/A | | | | | | | | | | | | | | |
| annotation | documentation Allocation Method of the new connection | | | | | | | | | | | | | | | |
| source | <pre><xs:element name="D2034_AllocationMethod" type="AllocationMethodType"> <xs:annotation> <xs:documentation>Allocation Method of the new connection</xs:documentation> </xs:annotation> </xs:element></pre> | | | | | | | | | | | | | | | |

element D2035_MainSPID

| | |
|-----------|--------------------------------------|
| diagram | |
| namespace | urn:bridgeall-com:cmaservice:data:v3 |

| type | restriction of xs:string | | | | | | | | | | | | |
|------------|----------------------------------------------------------------------------------------------------------------------------------------------------------------------------------------------------------------------------------------------------------------------------------------------------------------------------------------------------------------------------------------------------------------------------------------------------------------------------|------------|-------|------------|-----------|----|--|-----------|----|--|---------|----------|--|
| properties | content simple | | | | | | | | | | | | |
| used by | complexType MeterNetworkAssociationType | | | | | | | | | | | | |
| facets | <table border="1"> <thead> <tr> <th>Kind</th> <th>Value</th> <th>annotation</th> </tr> </thead> <tbody> <tr> <td>minLength</td> <td>12</td> <td></td> </tr> <tr> <td>maxLength</td> <td>12</td> <td></td> </tr> <tr> <td>pattern</td> <td>([0-9])*</td> <td></td> </tr> </tbody> </table> | Kind | Value | annotation | minLength | 12 | | maxLength | 12 | | pattern | ([0-9])* | |
| Kind | Value | annotation | | | | | | | | | | | |
| minLength | 12 | | | | | | | | | | | | |
| maxLength | 12 | | | | | | | | | | | | |
| pattern | ([0-9])* | | | | | | | | | | | | |
| annotation | documentation SPID for a Main Meter in a meter network | | | | | | | | | | | | |
| source | <pre> <xs:element name="D2035_MainSPID"> <xs:annotation> <xs:documentation>SPID for a Main Meter in a meter network</xs:documentation> </xs:annotation> <xs:simpleType> <xs:restriction base="xs:string"> <xs:maxLength value="12"/> <xs:minLength value="12"/> <xs:pattern value="([0-9])*"/> </xs:restriction> </xs:simpleType> </xs:element> </pre> | | | | | | | | | | | | |

element **D2036_SubSPID**

| diagram |  | | | | | | | | | | | | |
|------------|--------------------------------------------------------------------------------------------------------------------------------------------------------------------------------------------------------------------------------------------------------------------------------------------------------------------------------------------------------------------------------------------------------------------------------------------------------------------------|------------|-------|------------|-----------|----|--|-----------|----|--|---------|----------|--|
| namespace | urn:bridgeall-com:cmaservice:data:v3 | | | | | | | | | | | | |
| type | restriction of xs:string | | | | | | | | | | | | |
| properties | content simple | | | | | | | | | | | | |
| used by | complexType MeterNetworkAssociationType | | | | | | | | | | | | |
| facets | <table border="1"> <thead> <tr> <th>Kind</th> <th>Value</th> <th>annotation</th> </tr> </thead> <tbody> <tr> <td>minLength</td> <td>12</td> <td></td> </tr> <tr> <td>maxLength</td> <td>12</td> <td></td> </tr> <tr> <td>pattern</td> <td>([0-9])*</td> <td></td> </tr> </tbody> </table> | Kind | Value | annotation | minLength | 12 | | maxLength | 12 | | pattern | ([0-9])* | |
| Kind | Value | annotation | | | | | | | | | | | |
| minLength | 12 | | | | | | | | | | | | |
| maxLength | 12 | | | | | | | | | | | | |
| pattern | ([0-9])* | | | | | | | | | | | | |
| annotation | documentation SPID for a Sub-Meter in a meter network | | | | | | | | | | | | |
| source | <pre> <xs:element name="D2036_SubSPID"> <xs:annotation> <xs:documentation>SPID for a Sub-Meter in a meter network</xs:documentation> </xs:annotation> <xs:simpleType> <xs:restriction base="xs:string"> <xs:maxLength value="12"/> <xs:minLength value="12"/> <xs:pattern value="([0-9])*"/> </xs:restriction> </xs:simpleType> </xs:element> </pre> | | | | | | | | | | | | |

element D2041_PcentExemption

| diagram | | | | | | | | | | | | | | | | |
|----------------|------------------------------------------------------------------------------------------------------------------------------------------------------------------------------------------------------------------------------------------------------------------------------------------------------------------------------------------------------|------------|-------|------------|--------------|---|--|--------------|-----|--|-------------|---|--|----------------|---|--|
| namespace | urn:bridgeall-com:cmaservice:data:v3 | | | | | | | | | | | | | | | |
| type | percentage | | | | | | | | | | | | | | | |
| properties | content simple | | | | | | | | | | | | | | | |
| used by | complexTypes PremisesSpecialArrangementsUpdateNotificationType PremisesSpecialArrangementsUpdateType SpecialArrangementsUpdateNotificationType | | | | | | | | | | | | | | | |
| facets | <table border="1"> <thead> <tr> <th>Kind</th> <th>Value</th> <th>annotation</th> </tr> </thead> <tbody> <tr> <td>minInclusive</td> <td>0</td> <td></td> </tr> <tr> <td>maxInclusive</td> <td>100</td> <td></td> </tr> <tr> <td>totalDigits</td> <td>5</td> <td></td> </tr> <tr> <td>fractionDigits</td> <td>2</td> <td></td> </tr> </tbody> </table> | Kind | Value | annotation | minInclusive | 0 | | maxInclusive | 100 | | totalDigits | 5 | | fractionDigits | 2 | |
| Kind | Value | annotation | | | | | | | | | | | | | | |
| minInclusive | 0 | | | | | | | | | | | | | | | |
| maxInclusive | 100 | | | | | | | | | | | | | | | |
| totalDigits | 5 | | | | | | | | | | | | | | | |
| fractionDigits | 2 | | | | | | | | | | | | | | | |
| annotation | documentation The percentage of the D2004_ExemptCustomerFlag that is applied | | | | | | | | | | | | | | | |
| source | <pre> <xs:element name="D2041_PcentExemption" type="percentage"> <xs:annotation> <xs:documentation>The percentage of the D2004_ExemptCustomerFlag that is applied</xs:documentation> </xs:annotation> </xs:element> </pre> | | | | | | | | | | | | | | | |

element D2042_LiveRateableValue

| diagram | | | | | | | | | | | | | | | | |
|----------------|---------------------------------------------------------------------------------------------------------------------------------------------------------------------------------------------------------------------------------------------------------------------------------------------------------------------------------------------------------------------------------------------------------------------------|------------|-------|------------|--------------|---|--|--------------|---------------|--|-------------|----|--|----------------|---|--|
| namespace | urn:bridgeall-com:cmaservice:data:v3 | | | | | | | | | | | | | | | |
| type | restriction of xs:decimal | | | | | | | | | | | | | | | |
| properties | content simple | | | | | | | | | | | | | | | |
| used by | complexTypes T006.6_ProvideLiveRateableValueType T006.7_ProvideLiveRateableValueNotificationType T012.7_UpdateLiveRateableValueType T012.8_UpdateLiveRateableValueNotificationType | | | | | | | | | | | | | | | |
| facets | <table border="1"> <thead> <tr> <th>Kind</th> <th>Value</th> <th>annotation</th> </tr> </thead> <tbody> <tr> <td>minInclusive</td> <td>0</td> <td></td> </tr> <tr> <td>maxInclusive</td> <td>2000000000.99</td> <td></td> </tr> <tr> <td>totalDigits</td> <td>12</td> <td></td> </tr> <tr> <td>fractionDigits</td> <td>2</td> <td></td> </tr> </tbody> </table> | Kind | Value | annotation | minInclusive | 0 | | maxInclusive | 2000000000.99 | | totalDigits | 12 | | fractionDigits | 2 | |
| Kind | Value | annotation | | | | | | | | | | | | | | |
| minInclusive | 0 | | | | | | | | | | | | | | | |
| maxInclusive | 2000000000.99 | | | | | | | | | | | | | | | |
| totalDigits | 12 | | | | | | | | | | | | | | | |
| fractionDigits | 2 | | | | | | | | | | | | | | | |
| annotation | documentation Live Rateable Value of Eligible Premises in [£] | | | | | | | | | | | | | | | |
| source | <pre> <xs:element name="D2042_LiveRateableValue"> <xs:annotation> <xs:documentation>Live Rateable Value of Eligible Premises in [£]</xs:documentation> </xs:annotation> <xs:simpleType> <xs:restriction base="xs:decimal"> <xs:totalDigits value="12"/> </xs:restriction> </xs:simpleType> </xs:element> </pre> | | | | | | | | | | | | | | | |

| | |
|--|--------------------------------------------------------------------------------------------------------------------------------------------------------------------------------------------------------|
| | <pre> <xs:fractionDigits value="2"/> <xs:minInclusive value="0"/> <xs:maxInclusive value="2000000000.99"/> </xs:restriction> </xs:simpleType> </xs:element> </pre> |
|--|--------------------------------------------------------------------------------------------------------------------------------------------------------------------------------------------------------|

element **D2043_LPCConnectionRef**

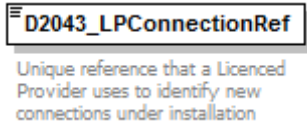
| | | | | | | | | | | |
|------------|-----------------------------------------------------------------------------------------------------------------------------------------------------------------------------------------------------------------------------------------------------------------------------------------------------------------------------------------------------------------------------------------------------------------------------------------------------------------------------------------------------------------|------------|-------|------------|-----------|----|--|---------|------------------------|--|
| diagram |  | | | | | | | | | |
| namespace | urn:bridgeall-com:cmaservice:data:v3 | | | | | | | | | |
| type | restriction of xs:string | | | | | | | | | |
| properties | content simple | | | | | | | | | |
| used by | complexTypes NewLPSPIDNotificationType NewSPIDNotificationType NewSPIDRequestType T012.0_MiscSPIDUpdateType | | | | | | | | | |
| facets | <table border="0"> <tr> <td>Kind</td> <td>Value</td> <td>annotation</td> </tr> <tr> <td>maxLength</td> <td>32</td> <td></td> </tr> <tr> <td>pattern</td> <td colspan="2">([a-z][A-Z][0-9][\V])*</td> </tr> </table> | Kind | Value | annotation | maxLength | 32 | | pattern | ([a-z][A-Z][0-9][\V])* | |
| Kind | Value | annotation | | | | | | | | |
| maxLength | 32 | | | | | | | | | |
| pattern | ([a-z][A-Z][0-9][\V])* | | | | | | | | | |
| annotation | documentation Unique reference that a Licenced Provider uses to identify new connections under installation | | | | | | | | | |
| source | <pre> <xs:element name="D2043_LPCConnectionRef"> <xs:annotation> <xs:documentation>Unique reference that a Licenced Provider uses to identify new connections under installation</xs:documentation> </xs:annotation> <xs:simpleType> <xs:restriction base="xs:string"> <xs:maxLength value="32"/> <xs:pattern value="([a-z][A-Z][0-9][\V])*" /> </xs:restriction> </xs:simpleType> </xs:element> </pre> | | | | | | | | | |

element **D3001_MeterId**

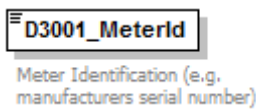
| | | | | | | | |
|------------|-------------------------------------------------------------------------------------------------------------------------------------------------------------------------------------------------------------------------------------------------------------------------------------------------------------------------------------------------------------------------------------------------------------------------------------------------------------------------------------------------------------------------------------------------------------------------------------------------------------------------------------------------------------------------------------------|------------|-------|------------|-----------|---|--|
| diagram |  | | | | | | |
| namespace | urn:bridgeall-com:cmaservice:data:v3 | | | | | | |
| type | string32 | | | | | | |
| properties | content simple | | | | | | |
| used by | complexTypes ChargeableMeterUpdateType DPMeterReadType LPMeterUpdateType MeterAssociationType MeterDisAssociationType MeterReadNotificationType MeterReadType MeterSWAPDetailsNotificationType MeterSWAPDetailsType MeterUpdateNotificationType MeterUpdateType T004.0_NewMeterType T004.1_NewMeterNotificationType T004.3_VirtualMeterType UpdateMeterLocationNotificationType UpdateMeterLocationType | | | | | | |
| facets | <table border="0"> <tr> <td>Kind</td> <td>Value</td> <td>annotation</td> </tr> <tr> <td>minLength</td> <td>1</td> <td></td> </tr> </table> | Kind | Value | annotation | minLength | 1 | |
| Kind | Value | annotation | | | | | |
| minLength | 1 | | | | | | |

| | |
|------------|--------------------------------------------------------------------------------------------------------------------------------------------------------------------------------------------------------------------------------------------------------|
| | maxLength 32 pattern ([^, \t\n\rj])* |
| annotation | documentation Meter Identification (e.g. manufacturers serial number) |
| source | <pre> <xs:element name="D3001_MeterId" type="string32"> <xs:annotation> <xs:documentation>Meter Identification (e.g. manufacturers serial number)</xs:documentation> </xs:annotation> </xs:element> </pre> |

element D3002_ChargeableMeterSize

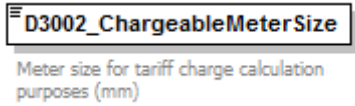
| | | | | | | | | | | |
|--------------|----------------------------------------------------------------------------------------------------------------------------------------------------------------------------------------------------------------------------------------------------------------------------------------------------------------------------------------------------------------------------------------------------------------------------------------------------------------|------------|-------|------------|--------------|---|--|--------------|------|--|
| diagram |  | | | | | | | | | |
| namespace | urn:bridgeall-com:cmaservice:data:v3 | | | | | | | | | |
| type | restriction of xs:short | | | | | | | | | |
| properties | content simple | | | | | | | | | |
| used by | complexTypes ChargeableMeterUpdateType T004.0 NewMeterType T004.1 NewMeterNotificationType T004.3 VirtualMeterType | | | | | | | | | |
| facets | <table border="0"> <tr> <td>Kind</td> <td>Value</td> <td>annotation</td> </tr> <tr> <td>minInclusive</td> <td>0</td> <td></td> </tr> <tr> <td>maxInclusive</td> <td>9999</td> <td></td> </tr> </table> | Kind | Value | annotation | minInclusive | 0 | | maxInclusive | 9999 | |
| Kind | Value | annotation | | | | | | | | |
| minInclusive | 0 | | | | | | | | | |
| maxInclusive | 9999 | | | | | | | | | |
| annotation | documentation Meter size for tariff charge calculation purposes (mm) | | | | | | | | | |
| source | <pre> <xs:element name="D3002_ChargeableMeterSize"> <xs:annotation> <xs:documentation>Meter size for tariff charge calculation purposes (mm)</xs:documentation> </xs:annotation> <xs:simpleType> <xs:restriction base="xs:short"> <xs:minInclusive value="0"/> <xs:maxInclusive value="9999"/> </xs:restriction> </xs:simpleType> </xs:element> </pre> | | | | | | | | | |

element D3003_PhysicalMeterSize

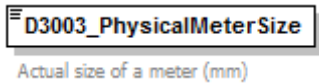
| | | | | | | | | | | |
|--------------|----------------------------------------------------------------------------------------------------------------------------------------------------------------------------------------------------------------------|------------|-------|------------|--------------|---|--|--------------|------|--|
| diagram |  | | | | | | | | | |
| namespace | urn:bridgeall-com:cmaservice:data:v3 | | | | | | | | | |
| type | restriction of xs:short | | | | | | | | | |
| properties | content simple | | | | | | | | | |
| used by | complexTypes MeterUpdateNotificationType MeterUpdateType T004.0 NewMeterType T004.1 NewMeterNotificationType T004.3 VirtualMeterType | | | | | | | | | |
| facets | <table border="0"> <tr> <td>Kind</td> <td>Value</td> <td>annotation</td> </tr> <tr> <td>minInclusive</td> <td>1</td> <td></td> </tr> <tr> <td>maxInclusive</td> <td>9999</td> <td></td> </tr> </table> | Kind | Value | annotation | minInclusive | 1 | | maxInclusive | 9999 | |
| Kind | Value | annotation | | | | | | | | |
| minInclusive | 1 | | | | | | | | | |
| maxInclusive | 9999 | | | | | | | | | |

| | |
|------------|---------------------------------------------------------------------------------------------------------------------------------------------------------------------------------------------------------------------------------------------------------------------------------------------------------------------------------------------------------------------------------------------------------------------------------|
| annotation | documentation Actual size of a meter (mm) |
| source | <pre><xs:element name="D3003_PhysicalMeterSize"> <xs:annotation> <xs:documentation>Actual size of a meter (mm)</xs:documentation> </xs:annotation> <xs:simpleType> <xs:restriction base="xs:short"> <xs:minInclusive value="1"/> <xs:maxInclusive value="9999"/> </xs:restriction> </xs:simpleType> </xs:element></pre> |

element D3004_NrDigits

| | | | | | | | | | | |
|--------------|-------------------------------------------------------------------------------------------------------------------------------------------------------------------------------------------------------------------------------------------------------------------------------------------------------------------------------------------------------------------------------------------------------------------------------------|------------|-------|------------|--------------|---|--|--------------|----|--|
| diagram |  | | | | | | | | | |
| namespace | urn:bridgeall-com:cmaservice:data:v3 | | | | | | | | | |
| type | restriction of xs:short | | | | | | | | | |
| properties | content simple | | | | | | | | | |
| used by | complexTypes MeterUpdateNotificationType MeterUpdateType T004.0_NewMeterType T004.1_NewMeterNotificationType T004.3_VirtualMeterType | | | | | | | | | |
| facets | <table border="0"> <tr> <td>Kind</td> <td>Value</td> <td>annotation</td> </tr> <tr> <td>minInclusive</td> <td>2</td> <td></td> </tr> <tr> <td>maxInclusive</td> <td>13</td> <td></td> </tr> </table> | Kind | Value | annotation | minInclusive | 2 | | maxInclusive | 13 | |
| Kind | Value | annotation | | | | | | | | |
| minInclusive | 2 | | | | | | | | | |
| maxInclusive | 13 | | | | | | | | | |
| annotation | documentation The number of digits on the meter register | | | | | | | | | |
| source | <pre><xs:element name="D3004_NrDigits"> <xs:annotation> <xs:documentation>The number of digits on the meter register</xs:documentation> </xs:annotation> <xs:simpleType> <xs:restriction base="xs:short"> <xs:minInclusive value="2"/> <xs:maxInclusive value="13"/> </xs:restriction> </xs:simpleType> </xs:element></pre> | | | | | | | | | |

element D3005_SewerageChargeableMeterSize

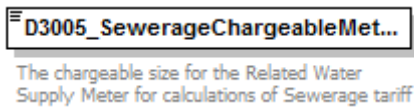
| | |
|------------|------------------------------------------------------------------------------------------------------------------------------------------------------------------------------------|
| diagram |  |
| namespace | urn:bridgeall-com:cmaservice:data:v3 |
| type | restriction of xs:short |
| properties | content simple |
| used by | complexTypes ChargeableMeterUpdateType T004.0_NewMeterType T004.1_NewMeterNotificationType T004.3_VirtualMeterType |

| | | | |
|------------|----------------------------------------------------------------------------------------------------------------------------------------------------------------------------------------------------------------------------------------------------------------------------------------------------------------------------------------------------------------------------------------------------------------------------------------------------------------------------------------------------------|--------------------------------------------------------------------------------------------|------------|
| facets | Kind minInclusive maxInclusive | Value 0 9999 | annotation |
| annotation | documentation | The chargeable size for the Related Water Supply Meter for calculations of Sewerage tariff | |
| source | <pre><xs:element name="D3005_SewerageChargeableMeterSize"> <xs:annotation> <xs:documentation>The chargeable size for the Related Water Supply Meter for calculations of Sewerage tariff</xs:documentation> </xs:annotation> <xs:simpleType> <xs:restriction base="xs:short"> <xs:minInclusive value="0"/> <xs:maxInclusive value="9999"/> </xs:restriction> </xs:simpleType> </xs:element></pre> | | |

element D3006_SubMeterId

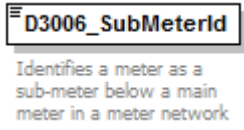
| | | | |
|------------|---------------------------------------------------------------------------------------------------------------------------------------------------------------------------------------------------------------------------------------------------------------------------------------------------------------------------------------------------------------------------------------------------------------------------------------------------------------------------------------------------------------|-------------------------------------------------------------------------|------------|
| diagram |  | | |
| namespace | urn:bridgeall-com:cmaservice:data:v3 | | |
| type | restriction of xs:string | | |
| properties | content | simple | |
| used by | complexType | MeterNetworkAssociationType | |
| facets | Kind minLength maxLength pattern | Value 1 32 ([^\t\n\rj]*) | annotation |
| annotation | documentation | Identifies a meter as a sub-meter below a main meter in a meter network | |
| source | <pre><xs:element name="D3006_SubMeterId"> <xs:annotation> <xs:documentation>Identifies a meter as a sub-meter below a main meter in a meter network</xs:documentation> </xs:annotation> <xs:simpleType> <xs:restriction base="xs:string"> <xs:minLength value="1"/> <xs:maxLength value="32"/> <xs:pattern value="([^\t\n\rj]*)"/> </xs:restriction> </xs:simpleType> </xs:element></pre> | | |

element **D3007_ReturnToSewerAllowance**

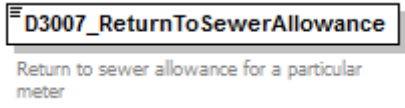
| | | | | | | | | | | | | | | | | |
|----------------|--------------------------------------------------------------------------------------------------------------------------------------------------------------------------------------------------------------------------------------------------------------------------------------------------------------------|------------|-------|------------|--------------|---|--|--------------|-----|--|-------------|---|--|----------------|---|--|
| diagram |  | | | | | | | | | | | | | | | |
| namespace | urn:bridgeall-com:cmaservice:data:v3 | | | | | | | | | | | | | | | |
| type | percentage | | | | | | | | | | | | | | | |
| properties | content simple | | | | | | | | | | | | | | | |
| used by | complexTypees ChargeableMeterUpdateType T004.0_NewMeterType T004.1_NewMeterNotificationType T004.3_VirtualMeterType | | | | | | | | | | | | | | | |
| facets | <table border="0"> <tr> <td>Kind</td> <td>Value</td> <td>annotation</td> </tr> <tr> <td>minInclusive</td> <td>0</td> <td></td> </tr> <tr> <td>maxInclusive</td> <td>100</td> <td></td> </tr> <tr> <td>totalDigits</td> <td>5</td> <td></td> </tr> <tr> <td>fractionDigits</td> <td>2</td> <td></td> </tr> </table> | Kind | Value | annotation | minInclusive | 0 | | maxInclusive | 100 | | totalDigits | 5 | | fractionDigits | 2 | |
| Kind | Value | annotation | | | | | | | | | | | | | | |
| minInclusive | 0 | | | | | | | | | | | | | | | |
| maxInclusive | 100 | | | | | | | | | | | | | | | |
| totalDigits | 5 | | | | | | | | | | | | | | | |
| fractionDigits | 2 | | | | | | | | | | | | | | | |
| annotation | documentation Return to sewer allowance for a particular meter | | | | | | | | | | | | | | | |
| source | <pre><xs:element name="D3007_ReturnToSewerAllowance" type="percentage"> <xs:annotation> <xs:documentation>Return to sewer allowance for a particular meter</xs:documentation> </xs:annotation> </xs:element></pre> | | | | | | | | | | | | | | | |

element **D3008_MeterRead**

| | | | | | | | | | | | | | |
|----------------|---------------------------------------------------------------------------------------------------------------------------------------------------------------------------------------------------------------------------------------------------------------------------------------------------------------------------------------------------------------------------------------------------------------------------------------------------------------------------------|------------|-------|------------|--------------|---|--|--------------|------------------|--|----------------|---|--|
| diagram |  | | | | | | | | | | | | |
| namespace | urn:bridgeall-com:cmaservice:data:v3 | | | | | | | | | | | | |
| type | restriction of xs:decimal | | | | | | | | | | | | |
| properties | content simple | | | | | | | | | | | | |
| used by | complexTypees DPMeterReadType MeterReadNotificationType MeterReadType MeterSWAPDetailsNotificationType MeterSWAPDetailsType | | | | | | | | | | | | |
| facets | <table border="0"> <tr> <td>Kind</td> <td>Value</td> <td>annotation</td> </tr> <tr> <td>minInclusive</td> <td>0</td> <td></td> </tr> <tr> <td>maxInclusive</td> <td>9999999999999999</td> <td></td> </tr> <tr> <td>fractionDigits</td> <td>0</td> <td></td> </tr> </table> | Kind | Value | annotation | minInclusive | 0 | | maxInclusive | 9999999999999999 | | fractionDigits | 0 | |
| Kind | Value | annotation | | | | | | | | | | | |
| minInclusive | 0 | | | | | | | | | | | | |
| maxInclusive | 9999999999999999 | | | | | | | | | | | | |
| fractionDigits | 0 | | | | | | | | | | | | |
| annotation | documentation Register read from a meter | | | | | | | | | | | | |
| source | <pre><xs:element name="D3008_MeterRead"> <xs:annotation> <xs:documentation>Register read from a meter</xs:documentation> </xs:annotation> <xs:simpleType> <xs:restriction base="xs:decimal"> <xs:minInclusive value="0"/> <xs:maxInclusive value="9999999999999999"/> <xs:fractionDigits value="0"/> </xs:restriction> </xs:simpleType> </xs:element></pre> | | | | | | | | | | | | |

element **D3009_MeterReadDate**

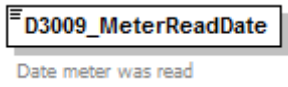
| | |
|------------|------------------------------------------------------------------------------------------------------------------------------------------------------------------------------------------------------------------------|
| diagram |  |
| namespace | urn:bridgeall-com:cmaservice:data:v3 |
| type | xs:date |
| properties | content simple |
| used by | complexTypees DPMeterReadType MeterReadNotificationType MeterReadType MeterSWAPDetailsNotificationType MeterSWAPDetailsType |
| annotation | documentation Date meter was read |
| source | <pre><xs:element name="D3009_MeterReadDate" type="xs:date"> <xs:annotation> <xs:documentation>Date meter was read </xs:documentation> </xs:annotation> </xs:element></pre> |

element **D3010_MeterReadType**

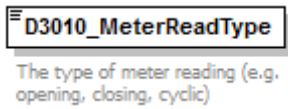
| diagram |  | | | | | | | | | | | | | | | | | | | | | | | | | | | | | | | | | | | | |
|-------------|--------------------------------------------------------------------------------------------------------------------------------------------------------------------------------------------------------------------------------------------------------------------------------------------------------------------------------------------------------------------------------------------------------------------------------------------------------------------------------------------------------------------------------------------------------------------------------------------------------------------------------------------------------------------------------------|------------|-------|------------|-------------|---|--|-------------|---|--|-------------|---|--|-------------|---|--|-------------|---|--|-------------|---|--|-------------|---|--|-------------|---|--|-------------|---|--|-------------|---|--|-------------|---|--|
| namespace | urn:bridgeall-com:cmaservice:data:v3 | | | | | | | | | | | | | | | | | | | | | | | | | | | | | | | | | | | | |
| type | ReadType | | | | | | | | | | | | | | | | | | | | | | | | | | | | | | | | | | | | |
| properties | content simple | | | | | | | | | | | | | | | | | | | | | | | | | | | | | | | | | | | | |
| used by | complexTypees DPMeterReadType MeterReadNotificationType MeterReadType MeterSWAPDetailsNotificationType MeterSWAPDetailsType | | | | | | | | | | | | | | | | | | | | | | | | | | | | | | | | | | | | |
| facets | <table border="1"> <thead> <tr> <th>Kind</th> <th>Value</th> <th>annotation</th> </tr> </thead> <tbody> <tr><td>enumeration</td><td>O</td><td></td></tr> <tr><td>enumeration</td><td>E</td><td></td></tr> <tr><td>enumeration</td><td>I</td><td></td></tr> <tr><td>enumeration</td><td>F</td><td></td></tr> <tr><td>enumeration</td><td>C</td><td></td></tr> <tr><td>enumeration</td><td>U</td><td></td></tr> <tr><td>enumeration</td><td>T</td><td></td></tr> <tr><td>enumeration</td><td>X</td><td></td></tr> <tr><td>enumeration</td><td>Y</td><td></td></tr> <tr><td>enumeration</td><td>R</td><td></td></tr> <tr><td>enumeration</td><td>S</td><td></td></tr> </tbody> </table> | Kind | Value | annotation | enumeration | O | | enumeration | E | | enumeration | I | | enumeration | F | | enumeration | C | | enumeration | U | | enumeration | T | | enumeration | X | | enumeration | Y | | enumeration | R | | enumeration | S | |
| Kind | Value | annotation | | | | | | | | | | | | | | | | | | | | | | | | | | | | | | | | | | | |
| enumeration | O | | | | | | | | | | | | | | | | | | | | | | | | | | | | | | | | | | | | |
| enumeration | E | | | | | | | | | | | | | | | | | | | | | | | | | | | | | | | | | | | | |
| enumeration | I | | | | | | | | | | | | | | | | | | | | | | | | | | | | | | | | | | | | |
| enumeration | F | | | | | | | | | | | | | | | | | | | | | | | | | | | | | | | | | | | | |
| enumeration | C | | | | | | | | | | | | | | | | | | | | | | | | | | | | | | | | | | | | |
| enumeration | U | | | | | | | | | | | | | | | | | | | | | | | | | | | | | | | | | | | | |
| enumeration | T | | | | | | | | | | | | | | | | | | | | | | | | | | | | | | | | | | | | |
| enumeration | X | | | | | | | | | | | | | | | | | | | | | | | | | | | | | | | | | | | | |
| enumeration | Y | | | | | | | | | | | | | | | | | | | | | | | | | | | | | | | | | | | | |
| enumeration | R | | | | | | | | | | | | | | | | | | | | | | | | | | | | | | | | | | | | |
| enumeration | S | | | | | | | | | | | | | | | | | | | | | | | | | | | | | | | | | | | | |
| annotation | documentation The type of meter reading (e.g. opening, closing, cyclic) | | | | | | | | | | | | | | | | | | | | | | | | | | | | | | | | | | | | |
| source | <pre><xs:element name="D3010_MeterReadType" type="ReadType"> <xs:annotation> <xs:documentation>The type of meter reading (e.g. opening, closing, cyclic)</xs:documentation> </xs:annotation> </xs:element></pre> | | | | | | | | | | | | | | | | | | | | | | | | | | | | | | | | | | | | |

element D3011_MeterReadFrequency

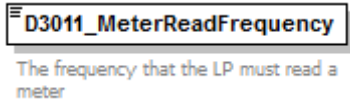
| | | | | | | | | | | | | | |
|-------------|---------------------------------------------------------------------------------------------------------------------------------------------------------------------------------------------------------------------------------------------------------------|------------|-------|------------|-------------|---|--|-------------|---|--|-------------|---|--|
| diagram |  | | | | | | | | | | | | |
| namespace | urn:bridgeall-com:cmaservice:data:v3 | | | | | | | | | | | | |
| type | ReadFrequencyType | | | | | | | | | | | | |
| properties | content simple | | | | | | | | | | | | |
| used by | complexTypees MeterUpdateNotificationType MeterUpdateType T004.0_NewMeterType T004.1_NewMeterNotificationType T004.3_VirtualMeterType | | | | | | | | | | | | |
| facets | <table border="0"> <tr> <td>Kind</td> <td>Value</td> <td>annotation</td> </tr> <tr> <td>enumeration</td> <td>B</td> <td></td> </tr> <tr> <td>enumeration</td> <td>M</td> <td></td> </tr> <tr> <td>enumeration</td> <td>N</td> <td></td> </tr> </table> | Kind | Value | annotation | enumeration | B | | enumeration | M | | enumeration | N | |
| Kind | Value | annotation | | | | | | | | | | | |
| enumeration | B | | | | | | | | | | | | |
| enumeration | M | | | | | | | | | | | | |
| enumeration | N | | | | | | | | | | | | |
| annotation | documentation The frequency that the LP must read a meter | | | | | | | | | | | | |
| source | <pre><xs:element name="D3011_MeterReadFrequency" type="ReadFrequencyType"> <xs:annotation> <xs:documentation>The frequency that the LP must read a meter </xs:documentation> </xs:annotation> </xs:element></pre> | | | | | | | | | | | | |

element D3012_ReRead

| | |
|------------|-------------------------------------------------------------------------------------------------------------------------------------------------------------------------------------------------------------------------------------------|
| diagram |  |
| namespace | urn:bridgeall-com:cmaservice:data:v3 |
| type | xs:boolean |
| properties | content simple |
| used by | complexTypees DPMeterReadType MeterReadNotificationType MeterReadType MeterSwapNotificationType MeterSwapType |
| annotation | documentation Flag to indicate if this read is a re-read |
| source | <pre><xs:element name="D3012_ReRead" type="xs:boolean"> <xs:annotation> <xs:documentation>Flag to indicate if this read is a re-read </xs:documentation> </xs:annotation> </xs:element></pre> |

element D3013_MeterMake

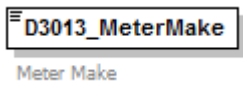
| | |
|------------|-------------------------------------------------------------------------------------|
| diagram |  |
| namespace | urn:bridgeall-com:cmaservice:data:v3 |
| type | string32 |
| properties | content simple |

| used by | complexTypees MeterUpdateNotificationType MeterUpdateType T004.0 NewMeterType T004.1 NewMeterNotificationType T004.3 VirtualMeterType | | | | | | | | | | | | |
|------------|-----------------------------------------------------------------------------------------------------------------------------------------------------------------------------------------------------------------------------------------------------------------------------------------------|---------------|-------|------------|-----------|---|--|-----------|----|--|---------|--|---------------|
| facets | <table border="1"> <thead> <tr> <th>Kind</th> <th>Value</th> <th>annotation</th> </tr> </thead> <tbody> <tr> <td>minLength</td> <td>1</td> <td></td> </tr> <tr> <td>maxLength</td> <td>32</td> <td></td> </tr> <tr> <td>pattern</td> <td></td> <td>([^\t\n\rj])*</td> </tr> </tbody> </table> | Kind | Value | annotation | minLength | 1 | | maxLength | 32 | | pattern | | ([^\t\n\rj])* |
| Kind | Value | annotation | | | | | | | | | | | |
| minLength | 1 | | | | | | | | | | | | |
| maxLength | 32 | | | | | | | | | | | | |
| pattern | | ([^\t\n\rj])* | | | | | | | | | | | |
| annotation | documentation Meter Make | | | | | | | | | | | | |
| source | <pre><xs:element name="D3013_MeterMake" type="string32"> <xs:annotation> <xs:documentation>Meter Make</xs:documentation> </xs:annotation> </xs:element></pre> | | | | | | | | | | | | |

element D3014_ManufacturerMeterSerialNr

| diagram | | | | | | | | | | | | | |
|------------|-----------------------------------------------------------------------------------------------------------------------------------------------------------------------------------------------------------------------------------------------------------------------------------------------|---------------|-------|------------|-----------|---|--|-----------|----|--|---------|--|---------------|
| namespace | urn:bridgeall-com:cmaservice:data:v3 | | | | | | | | | | | | |
| type | string32 | | | | | | | | | | | | |
| properties | content simple | | | | | | | | | | | | |
| used by | complexTypees MeterUpdateNotificationType MeterUpdateType T004.0 NewMeterType T004.1 NewMeterNotificationType T004.3 VirtualMeterType | | | | | | | | | | | | |
| facets | <table border="1"> <thead> <tr> <th>Kind</th> <th>Value</th> <th>annotation</th> </tr> </thead> <tbody> <tr> <td>minLength</td> <td>1</td> <td></td> </tr> <tr> <td>maxLength</td> <td>32</td> <td></td> </tr> <tr> <td>pattern</td> <td></td> <td>([^\t\n\rj])*</td> </tr> </tbody> </table> | Kind | Value | annotation | minLength | 1 | | maxLength | 32 | | pattern | | ([^\t\n\rj])* |
| Kind | Value | annotation | | | | | | | | | | | |
| minLength | 1 | | | | | | | | | | | | |
| maxLength | 32 | | | | | | | | | | | | |
| pattern | | ([^\t\n\rj])* | | | | | | | | | | | |
| annotation | documentation Meter Serial Number | | | | | | | | | | | | |
| source | <pre><xs:element name="D3014_ManufacturerMeterSerialNr" type="string32"> <xs:annotation> <xs:documentation>Meter Serial Number</xs:documentation> </xs:annotation> </xs:element></pre> | | | | | | | | | | | | |

element D3015_datalogger_SW

| | |
|------------|----------------------------------------------------------------------------------------------------------------------------------------------------------------------------------------------------------------------------------------|
| diagram | |
| namespace | urn:bridgeall-com:cmaservice:data:v3 |
| type | xs:boolean |
| properties | content simple |
| used by | complexTypees MeterUpdateNotificationType MeterUpdateType T004.0 NewMeterType T004.1 NewMeterNotificationType |
| annotation | documentation Specifies the presence of a Scottish Water datalogger |
| source | <pre><xs:element name="D3015_datalogger_SW" type="xs:boolean"> <xs:annotation> <xs:documentation>Specifies the presence of a Scottish Water datalogger</xs:documentation> </xs:annotation></pre> |

| | |
|--|---------------|
| | </xs:element> |
|--|---------------|

element D3016_datalogger_NonSW

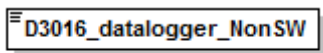
| | |
|------------|-------------------------------------------------------------------------------------------------------------------------------------------------------------------------------------------------------------------------------------------------------------------|
| diagram |  <p>Specifies the presence of a non Scottish Water datalogger</p> |
| namespace | urn:bridgeall-com:cmaservice:data:v3 |
| type | xs:boolean |
| properties | content simple |
| used by | complexTypes MeterUpdateNotificationType MeterUpdateType T004.0_NewMeterType T004.1_NewMeterNotificationType |
| annotation | documentation Specifies the presence of a non Scottish Water datalogger |
| source | <pre><xs:element name="D3016_datalogger_NonSW" type="xs:boolean"> <xs:annotation> <xs:documentation>Specifies the presence of a non Scottish Water datalogger</xs:documentation> </xs:annotation> </xs:element></pre> |

element D3017_GISX

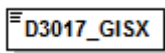
| | | | | | | | | | | |
|----------------|------------------------------------------------------------------------------------------------------------------------------------------------------------------------------------------------------------------------------------------------------------------------------------------------------------------------------------------------------------------------------------------------------------------------------------------------|------------|-------|------------|-------------|---|--|----------------|---|--|
| diagram |  <p>Specifies the X coordinate of the location of the meter</p> | | | | | | | | | |
| namespace | urn:bridgeall-com:cmaservice:data:v3 | | | | | | | | | |
| type | restriction of xs:decimal | | | | | | | | | |
| properties | content simple | | | | | | | | | |
| used by | complexTypes MeterUpdateNotificationType MeterUpdateType T004.0_NewMeterType T004.1_NewMeterNotificationType | | | | | | | | | |
| facets | <table border="0"> <tr> <td>Kind</td> <td>Value</td> <td>annotation</td> </tr> <tr> <td>totalDigits</td> <td>7</td> <td></td> </tr> <tr> <td>fractionDigits</td> <td>1</td> <td></td> </tr> </table> | Kind | Value | annotation | totalDigits | 7 | | fractionDigits | 1 | |
| Kind | Value | annotation | | | | | | | | |
| totalDigits | 7 | | | | | | | | | |
| fractionDigits | 1 | | | | | | | | | |
| annotation | documentation Specifies the X coordinate of the location of the meter | | | | | | | | | |
| source | <pre><xs:element name="D3017_GISX"> <xs:annotation> <xs:documentation>Specifies the X coordinate of the location of the meter</xs:documentation> </xs:annotation> <xs:simpleType> <xs:restriction base="xs:decimal"> <xs:totalDigits value="7"/> <xs:fractionDigits value="1"/> </xs:restriction> </xs:simpleType> </xs:element></pre> | | | | | | | | | |

element **D3018_GISY**

| | | | | | | | | | | |
|----------------|------------------------------------------------------------------------------------------------------------------------------------------------------------------------------------------------------------------------------------------------------------------------------------------------------------------------------------------------------------------------------------------------------------------------------------------------|------------|-------|------------|-------------|---|--|----------------|---|--|
| diagram |  | | | | | | | | | |
| namespace | urn:bridgeall-com:cmaservice:data:v3 | | | | | | | | | |
| type | restriction of xs:decimal | | | | | | | | | |
| properties | content simple | | | | | | | | | |
| used by | complexTypes MeterUpdateNotificationType MeterUpdateType T004.0_NewMeterType T004.1_NewMeterNotificationType | | | | | | | | | |
| facets | <table border="0"> <tr> <td>Kind</td> <td>Value</td> <td>annotation</td> </tr> <tr> <td>totalDigits</td> <td>8</td> <td></td> </tr> <tr> <td>fractionDigits</td> <td>1</td> <td></td> </tr> </table> | Kind | Value | annotation | totalDigits | 8 | | fractionDigits | 1 | |
| Kind | Value | annotation | | | | | | | | |
| totalDigits | 8 | | | | | | | | | |
| fractionDigits | 1 | | | | | | | | | |
| annotation | documentation Specifies the Y coordinate of the location of the meter | | | | | | | | | |
| source | <pre><xs:element name="D3018_GISY"> <xs:annotation> <xs:documentation>Specifies the Y coordinate of the location of the meter</xs:documentation> </xs:annotation> <xs:simpleType> <xs:restriction base="xs:decimal"> <xs:totalDigits value="8"/> <xs:fractionDigits value="1"/> </xs:restriction> </xs:simpleType> </xs:element></pre> | | | | | | | | | |

element **D3019_GISZFreeDescriptor**

| | | | | | | | |
|------------|-----------------------------------------------------------------------------------------------------------------------------------------------------------------------------------------------------------------------------------------------------------------------------------------------------------------------------------------------------------------------------------------------------------------------|------------|-------|------------|-----------|-----|--|
| diagram |  | | | | | | |
| namespace | urn:bridgeall-com:cmaservice:data:v3 | | | | | | |
| type | restriction of xs:string | | | | | | |
| properties | content simple | | | | | | |
| used by | complexTypes MeterUpdateNotificationType T004.0_NewMeterType T004.1_NewMeterNotificationType UpdateMeterLocationNotificationType UpdateMeterLocationType | | | | | | |
| facets | <table border="0"> <tr> <td>Kind</td> <td>Value</td> <td>annotation</td> </tr> <tr> <td>maxLength</td> <td>255</td> <td></td> </tr> </table> | Kind | Value | annotation | maxLength | 255 | |
| Kind | Value | annotation | | | | | |
| maxLength | 255 | | | | | | |
| annotation | documentation Specifies the Z Free Descriptor of the location of the meter | | | | | | |
| source | <pre><xs:element name="D3019_GISZFreeDescriptor"> <xs:annotation> <xs:documentation>Specifies the Z Free Descriptor of the location of the meter</xs:documentation> </xs:annotation> <xs:simpleType> <xs:restriction base="xs:string"> <xs:maxLength value="255"/> </xs:restriction> </xs:simpleType> </xs:element></pre> | | | | | | |

element D3020_Rollover_Indicator

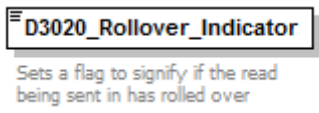
| | |
|------------|-----------------------------------------------------------------------------------------------------------------------------------------------------------------------------------------------------------------------------------------------------------------------------|
| diagram |  |
| namespace | urn:bridgeall-com:cmaservice:data:v3 |
| type | xs:boolean |
| properties | content simple |
| used by | complexTypees MeterReadType MeterSWAPDetailsType |
| annotation | documentation Sets a flag to signify if the read being sent in has rolled over |
| source | <pre><xs:element name="D3020_Rollover_Indicator" type="xs:boolean"> <xs:annotation> <xs:documentation>Sets a flag to signify if the read being sent in has rolled over </xs:documentation> </xs:annotation> </xs:element></pre> |

element D3021_Rollover_Flag

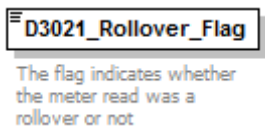
| | |
|------------|-----------------------------------------------------------------------------------------------------------------------------------------------------------------------------------------------------------------------------------------------------------------------|
| diagram |  |
| namespace | urn:bridgeall-com:cmaservice:data:v3 |
| type | xs:boolean |
| properties | content simple |
| used by | complexTypees DPMeterReadType MeterReadNotificationType MeterSWAPDetailsNotificationType |
| annotation | documentation The flag indicates whether the meter read was a rollover or not |
| source | <pre><xs:element name="D3021_Rollover_Flag" type="xs:boolean"> <xs:annotation> <xs:documentation>The flag indicates whether the meter read was a rollover or not </xs:documentation> </xs:annotation> </xs:element></pre> |

element D3022_MeterTreatment

| | |
|------------|---------------------------------------------------------------------------------------------------|
| diagram |  |
| namespace | urn:bridgeall-com:cmaservice:data:v3 |
| type | MeterTreatmentType |
| properties | content simple |
| used by | complexTypees T004.0_NewMeterType T004.1_NewMeterNotificationType |

| | | | |
|------------|-----------------------------------------------------------------------------------------------------------------------------------------------------------------------------------------------------------------------------------------|---------------------------|------------|
| facets | Kind enumeration | Value SWWater | annotation |
| | enumeration | PrivateWater | |
| | enumeration | PrivateEffluent | |
| | enumeration | TankeredEffluent | |
| | enumeration | LogicalWater | |
| | enumeration | PseudoWater | |
| annotation | documentation | Meter Treatment Indicator | |
| source | <pre><xs:element name="D3022_MeterTreatment" type="MeterTreatmentType"> <xs:annotation> <xs:documentation>Meter Treatment Indicator</xs:documentation> </xs:annotation> </xs:element></pre> | | |

element D3023_AccreditedEntityInstall

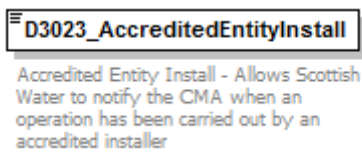
| | |
|------------|------------------------------------------------------------------------------------------------------------------------------------------------------------------------------------------------------------------------------------------------------------------------------------------------------------------------------------------------------|
| diagram |  |
| namespace | urn:bridgeall-com:cmaservice:data:v3 |
| type | xs:boolean |
| properties | content simple |
| used by | complexType T004.0_NewMeterType |
| annotation | documentation Accredited Entity Install - Allows Scottish Water to notify the CMA when an operation has been carried out by an accredited installer |
| source | <pre><xs:element name="D3023_AccreditedEntityInstall" type="xs:boolean"> <xs:annotation> <xs:documentation>Accredited Entity Install - Allows Scottish Water to notify the CMA when an operation has been carried out by an accredited installer</xs:documentation> </xs:annotation> </xs:element></pre> |

element D3024_MDVol

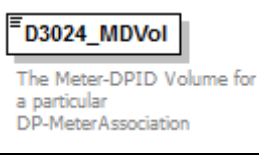
| | | | | | | | | | | |
|--------------|-------------------------------------------------------------------------------------------------------------------------------------------------------------------------------------------------------|------------|-------|------------|--------------|---|--|--------------|-----|--|
| diagram |  | | | | | | | | | |
| namespace | urn:bridgeall-com:cmaservice:data:v3 | | | | | | | | | |
| type | percentage | | | | | | | | | |
| properties | content simple | | | | | | | | | |
| used by | complexType MeterAssociationType | | | | | | | | | |
| facets | <table border="0"> <tr> <td>Kind</td> <td>Value</td> <td>annotation</td> </tr> <tr> <td>minInclusive</td> <td>0</td> <td></td> </tr> <tr> <td>maxInclusive</td> <td>100</td> <td></td> </tr> </table> | Kind | Value | annotation | minInclusive | 0 | | maxInclusive | 100 | |
| Kind | Value | annotation | | | | | | | | |
| minInclusive | 0 | | | | | | | | | |
| maxInclusive | 100 | | | | | | | | | |

| | |
|------------|--------------------------------------------------------------------------------------------------------------------------------------------------------------------------------------------------------------|
| | totalDigits 5 fractionDigits 2 |
| annotation | documentation The Meter-DPID Volume for a particular DP-MeterAssociation |
| source | <xs:element name="D3024_MDVol" type="percentage"> <xs:annotation> <xs:documentation>The Meter-DPID Volume for a particular DP-MeterAssociation</xs:documentation> </xs:annotation> </xs:element> |

element D3025_MeterLocationCode

| | |
|------------|--------------------------------------------------------------------------------------------------------------------------------------------------------------------------------------------------|
| diagram |  |
| namespace | urn:bridgeall-com:cmaservice:data:v3 |
| type | MeterLocationCodeType |
| properties | content simple |
| used by | complexTypees T004.0_NewMeterType T004.1_NewMeterNotificationType UpdateMeterLocationNotificationType UpdateMeterLocationType |
| facets | Kind Value annotation enumeration M1 enumeration M2 enumeration M3 enumeration M4 |
| annotation | documentation Meter Location Code |
| source | <xs:element name="D3025_MeterLocationCode" type="MeterLocationCodeType"> <xs:annotation> <xs:documentation>Meter Location Code</xs:documentation> </xs:annotation> </xs:element> |

element D3026_MeterNetworkAssociation

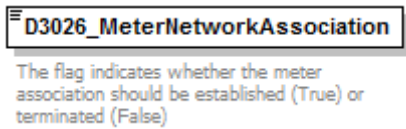
| | |
|------------|--------------------------------------------------------------------------------------------------------------------------------------------------------------------------------------------------------------------------------------------------------|
| diagram |  |
| namespace | urn:bridgeall-com:cmaservice:data:v3 |
| type | xs:boolean |
| properties | content simple |
| used by | complexType MeterNetworkAssociationType |
| annotation | documentation The flag indicates whether the meter association should be established (True) or terminated (False) |
| source | <xs:element name="D3026_MeterNetworkAssociation" type="xs:boolean"> <xs:annotation> <xs:documentation>The flag indicates whether the meter association should be established (True) or terminated (False)</xs:documentation> </xs:annotation> |

| | |
|--|---------------|
| | </xs:element> |
|--|---------------|

element D3027_MainMeterId

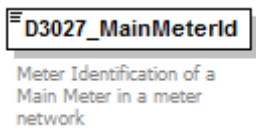
| diagram |  | | | | | | | | | | | | |
|------------|----------------------------------------------------------------------------------------------------------------------------------------------------------------------------------------------------------------------------------------------------------------------------------------------|------------|-------|------------|-----------|---|--|-----------|----|--|---------|--------------|--|
| namespace | urn:bridgeall-com:cmaservice:data:v3 | | | | | | | | | | | | |
| type | string32 | | | | | | | | | | | | |
| properties | content simple | | | | | | | | | | | | |
| used by | complexType MeterNetworkAssociationType | | | | | | | | | | | | |
| facets | <table border="1"> <thead> <tr> <th>Kind</th> <th>Value</th> <th>annotation</th> </tr> </thead> <tbody> <tr> <td>minLength</td> <td>1</td> <td></td> </tr> <tr> <td>maxLength</td> <td>32</td> <td></td> </tr> <tr> <td>pattern</td> <td>([^\s\r\n]*)</td> <td></td> </tr> </tbody> </table> | Kind | Value | annotation | minLength | 1 | | maxLength | 32 | | pattern | ([^\s\r\n]*) | |
| Kind | Value | annotation | | | | | | | | | | | |
| minLength | 1 | | | | | | | | | | | | |
| maxLength | 32 | | | | | | | | | | | | |
| pattern | ([^\s\r\n]*) | | | | | | | | | | | | |
| annotation | documentation Meter Identification of a Main Meter in a meter network | | | | | | | | | | | | |
| source | <pre><xs:element name="D3027_MainMeterId" type="string32"> <xs:annotation> <xs:documentation>Meter Identification of a Main Meter in a meter network</xs:documentation> </xs:annotation> </xs:element></pre> | | | | | | | | | | | | |

element D3028_SReadReasonCode

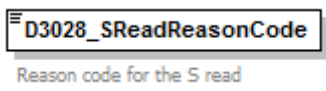
| diagram |  | | | | | | | | | | | | | | | | | | |
|-------------|--------------------------------------------------------------------------------------------------------------------------------------------------------------------------------------------------------------------------------------------------------------------------------------------------------------------------------------------------------------------------------------------------------------|------------|-------|------------|-------------|-----|--|-------------|-----|--|-------------|-----|--|-------------|-----|--|-------------|-----|--|
| namespace | urn:bridgeall-com:cmaservice:data:v3 | | | | | | | | | | | | | | | | | | |
| type | SReadReasonCodeType | | | | | | | | | | | | | | | | | | |
| properties | content simple | | | | | | | | | | | | | | | | | | |
| used by | complexType MeterReadNotificationType MeterReadType | | | | | | | | | | | | | | | | | | |
| facets | <table border="1"> <thead> <tr> <th>Kind</th> <th>Value</th> <th>annotation</th> </tr> </thead> <tbody> <tr> <td>enumeration</td> <td>WMD</td> <td></td> </tr> <tr> <td>enumeration</td> <td>NMA</td> <td></td> </tr> <tr> <td>enumeration</td> <td>MNF</td> <td></td> </tr> <tr> <td>enumeration</td> <td>NSA</td> <td></td> </tr> <tr> <td>enumeration</td> <td>PLR</td> <td></td> </tr> </tbody> </table> | Kind | Value | annotation | enumeration | WMD | | enumeration | NMA | | enumeration | MNF | | enumeration | NSA | | enumeration | PLR | |
| Kind | Value | annotation | | | | | | | | | | | | | | | | | |
| enumeration | WMD | | | | | | | | | | | | | | | | | | |
| enumeration | NMA | | | | | | | | | | | | | | | | | | |
| enumeration | MNF | | | | | | | | | | | | | | | | | | |
| enumeration | NSA | | | | | | | | | | | | | | | | | | |
| enumeration | PLR | | | | | | | | | | | | | | | | | | |
| annotation | documentation Reason code for the S read | | | | | | | | | | | | | | | | | | |
| source | <pre><xs:element name="D3028_SReadReasonCode" type="SReadReasonCodeType"> <xs:annotation> <xs:documentation>Reason code for the S read</xs:documentation> </xs:annotation> </xs:element></pre> | | | | | | | | | | | | | | | | | | |

element **D3029_SReadRemedialWorkIndicator**

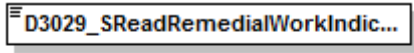
| | |
|------------|--------------------------------------------------------------------------------------------------------------------------------------------------------------------------------------------------------------------------------------------------------------------------------------------------------------------------------------------------------------|
| diagram |  <p>The flag indicates whether, or not, the Incoming LP has initiated remedial work to remove the reason for the S read to be required</p> |
| namespace | urn:bridgeall-com:cmaservice:data:v3 |
| type | xs:boolean |
| properties | content simple |
| used by | complexTypees MeterReadNotificationType MeterReadType |
| annotation | documentation The flag indicates whether, or not, the Incoming LP has initiated remedial work to remove the reason for the S read to be required |
| source | <pre><xs:element name="D3029_SReadRemedialWorkIndicator" type="xs:boolean"> <xs:annotation> <xs:documentation>The flag indicates whether, or not, the Incoming LP has initiated remedial work to remove the reason for the S read to be required</xs:documentation> </xs:annotation> </xs:element></pre> |

element **D4001_OrgId**

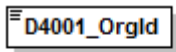
| diagram |  <p>D4001 Unique ID for each organisation (SW, Licensed Providers etc) transacting flows with CMA</p> | | | | | | | | | | | | |
|------------|-------------------------------------------------------------------------------------------------------------------------------------------------------------------------------------------------------------------------------------------------------------------------------------------------------------------------------------------------------------------------------------------------------------------------------------------------------------------------------------------------------------------------------------------|------------|-------|------------|-----------|---|--|-----------|---|--|---------|----------------------|--|
| namespace | urn:bridgeall-com:cmaservice:data:v3 | | | | | | | | | | | | |
| type | restriction of xs:string | | | | | | | | | | | | |
| properties | content simple | | | | | | | | | | | | |
| used by | complexTypees CustomerNameUpdatedNotificationType NewSPIDNotificationType NewSPIDRequestType NotifyRSDType | | | | | | | | | | | | |
| facets | <table border="1"> <thead> <tr> <th>Kind</th> <th>Value</th> <th>annotation</th> </tr> </thead> <tbody> <tr> <td>minLength</td> <td>1</td> <td></td> </tr> <tr> <td>maxLength</td> <td>6</td> <td></td> </tr> <tr> <td>pattern</td> <td>([a-zA-Z0-9][\-\-])*</td> <td></td> </tr> </tbody> </table> | Kind | Value | annotation | minLength | 1 | | maxLength | 6 | | pattern | ([a-zA-Z0-9][\-\-])* | |
| Kind | Value | annotation | | | | | | | | | | | |
| minLength | 1 | | | | | | | | | | | | |
| maxLength | 6 | | | | | | | | | | | | |
| pattern | ([a-zA-Z0-9][\-\-])* | | | | | | | | | | | | |
| annotation | documentation D4001 Unique ID for each organisation (SW, Licensed Providers etc) transacting flows with CMA | | | | | | | | | | | | |
| source | <pre><xs:element name="D4001_OrgId"> <xs:annotation> <xs:documentation>D4001 Unique ID for each organisation (SW, Licensed Providers etc) transacting flows with CMA</xs:documentation> </xs:annotation> <xs:simpleType> <xs:restriction base="xs:string"> <xs:minLength value="1"/> <xs:maxLength value="6"/> <xs:pattern value="([a-zA-Z0-9][\-\-])*" /> </xs:restriction> </xs:simpleType> </xs:element></pre> | | | | | | | | | | | | |

element D4002_RegistrationStartDate

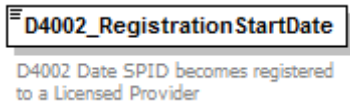
| | |
|------------|-------------------------------------------------------------------------------------------------------------------------------------------------------------------------------------------------------------------------------------------------------------------------|
| diagram |  |
| namespace | urn:bridgeall-com:cmaservice:data:v3 |
| type | xs:date |
| properties | content simple |
| used by | complexTypes NotifyRSDType RegistrationStartType T003.1_RegistrationApplicationType |
| annotation | documentation D4002 Date SPID becomes registered to a Licensed Provider |
| source | <pre><xs:element name="D4002_RegistrationStartDate" type="xs:date"> <xs:annotation> <xs:documentation>D4002 Date SPID becomes registered to a Licensed Provider</xs:documentation> </xs:annotation> </xs:element></pre> |

element D4003_Comment

| | | | | | | | | | | |
|------------|-------------------------------------------------------------------------------------------------------------------------------------------------------------------------------------------------------------------------------------------------------------------------------------------------------------------------------------------------------------------------------------------------------------------------------------------------------------------------------------------------------------------------------------------------------------------------------------------------------------------------------------------------------------------------------------------------------------------------------------------------------------------------------------------------------------------------------------------------------------------------------------------------------------|------------|-------|------------|-----------|-----|--|------------|----------|--|
| diagram |  | | | | | | | | | |
| namespace | urn:bridgeall-com:cmaservice:data:v3 | | | | | | | | | |
| type | restriction of xs:string | | | | | | | | | |
| properties | content simple | | | | | | | | | |
| used by | complexTypes CancelRegistrationNotificationType CancelRegistrationOutType ChargeableMeterUpdateType DPIDUpdateType MeterUpdateNotificationType MeterUpdateType ServiceElementUpdateNotificationType SewerageServiceElementUpdateNotificationType T012.0_MiscSPIDUpdateType T012.1_ServiceElementUpdateType T012.3_SewerageServiceElementUpdateType T034.0_VacSchemeApplication T034.1_VacSchemeGracePeriodNotification T034.2_VacSchemeGraceEndNotification T034.3_VacSchemeApplicationNotification T034.4_VacSchemeApplicationConfirmationOrCancellation T034.5_VacSchemeApplicationConfirmationOrCancellationNotification | | | | | | | | | |
| facets | <table border="0"> <tr> <td>Kind</td> <td>Value</td> <td>annotation</td> </tr> <tr> <td>maxLength</td> <td>255</td> <td></td> </tr> <tr> <td>whiteSpace</td> <td>preserve</td> <td></td> </tr> </table> | Kind | Value | annotation | maxLength | 255 | | whiteSpace | preserve | |
| Kind | Value | annotation | | | | | | | | |
| maxLength | 255 | | | | | | | | | |
| whiteSpace | preserve | | | | | | | | | |
| annotation | documentation Generic text field for (short) comments and notes related to the transaction | | | | | | | | | |
| source | <pre><xs:element name="D4003_Comment"> <xs:annotation> <xs:documentation>Generic text field for (short) comments and notes related to the transaction</xs:documentation> </xs:annotation> <xs:simpleType> <xs:restriction base="xs:string"> <xs:maxLength value="255"/> <xs:whiteSpace value="preserve"/> </xs:restriction> </xs:simpleType> </xs:element></pre> | | | | | | | | | |

| | |
|--|-------------------------------------------------------|
| | <pre></xs:simpleType> </xs:element></pre> |
|--|-------------------------------------------------------|

element **D4004_ReturnCode**

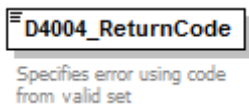
| | | | |
|------------|-----------------------------------------------------------------------------------|-------------------------------------------------------------------------------------------------------------------------------|------------|
| diagram |  | | |
| namespace | urn:bridgeall-com:cmaservice:data:v3 | | |
| type | ReturnCodeType | | |
| properties | content simple | | |
| used by | complexTypes | NotificationType T009.4 NotificationType T034.2 VacSchemeGraceEndNotification | |
| facets | Kind | Value | annotation |
| | enumeration | AA | |
| | enumeration | AB | |
| | enumeration | AC | |
| | enumeration | AD | |
| | enumeration | AE | |
| | enumeration | AF | |
| | enumeration | AG | |
| | enumeration | AH | |
| | enumeration | AI | |
| | enumeration | AJ | |
| | enumeration | AK | |
| | enumeration | AL | |
| | enumeration | AM | |
| | enumeration | AN | |
| | enumeration | AO | |
| | enumeration | AP | |
| | enumeration | AQ | |
| | enumeration | AR | |
| | enumeration | AS | |
| | enumeration | AT | |
| | enumeration | AU | |
| | enumeration | AV | |
| | enumeration | AW | |
| | enumeration | AX | |
| | enumeration | AY | |
| | enumeration | AZ | |
| | enumeration | BA | |
| | enumeration | BB | |
| | enumeration | BC | |
| | enumeration | BD | |
| | enumeration | BE | |
| | enumeration | BF | |
| | enumeration | BG | |
| | enumeration | BH | |
| | enumeration | BI | |

| | |
|-------------|----|
| enumeration | BL |
| enumeration | BN |
| enumeration | BV |
| enumeration | BZ |
| enumeration | OK |
| enumeration | DA |
| enumeration | DB |
| enumeration | DC |
| enumeration | DD |
| enumeration | DE |
| enumeration | DF |
| enumeration | DG |
| enumeration | DH |
| enumeration | DI |
| enumeration | DJ |
| enumeration | DK |
| enumeration | DL |
| enumeration | DM |
| enumeration | DN |
| enumeration | DO |
| enumeration | DP |
| enumeration | DQ |
| enumeration | DR |
| enumeration | DS |
| enumeration | DT |
| enumeration | DU |
| enumeration | DV |
| enumeration | DW |
| enumeration | DX |
| enumeration | DY |
| enumeration | DZ |
| enumeration | EA |
| enumeration | EB |
| enumeration | EC |
| enumeration | ED |
| enumeration | EE |
| enumeration | EF |
| enumeration | EG |
| enumeration | EH |
| enumeration | EI |
| enumeration | EJ |
| enumeration | EK |
| enumeration | EL |
| enumeration | EM |
| enumeration | EN |
| enumeration | EO |
| enumeration | EP |
| enumeration | EQ |
| enumeration | ER |

| | |
|-------------|----|
| enumeration | ES |
| enumeration | ET |
| enumeration | EU |
| enumeration | EV |
| enumeration | EW |
| enumeration | EX |
| enumeration | EY |
| enumeration | EZ |
| enumeration | FA |
| enumeration | FB |
| enumeration | FC |
| enumeration | FD |
| enumeration | FE |
| enumeration | FF |
| enumeration | FG |
| enumeration | FH |
| enumeration | FI |
| enumeration | FJ |
| enumeration | FK |
| enumeration | FL |
| enumeration | FM |
| enumeration | FN |
| enumeration | FO |
| enumeration | FP |
| enumeration | FQ |
| enumeration | FR |
| enumeration | FS |
| enumeration | FT |
| enumeration | FU |
| enumeration | FV |
| enumeration | FW |
| enumeration | FX |
| enumeration | FY |
| enumeration | FZ |
| enumeration | GA |
| enumeration | GB |
| enumeration | GC |
| enumeration | GD |
| enumeration | GE |
| enumeration | GF |
| enumeration | GG |
| enumeration | GH |
| enumeration | GI |
| enumeration | GJ |
| enumeration | GK |
| enumeration | GL |
| enumeration | GM |
| enumeration | GN |
| enumeration | GO |

| | |
|-------------|----|
| enumeration | GP |
| enumeration | GQ |
| enumeration | GR |
| enumeration | GS |
| enumeration | GT |
| enumeration | GU |
| enumeration | GV |
| enumeration | GW |
| enumeration | GX |
| enumeration | GY |
| enumeration | GZ |
| enumeration | HA |
| enumeration | HB |
| enumeration | HC |
| enumeration | HD |
| enumeration | HE |
| enumeration | HF |
| enumeration | HG |
| enumeration | HH |
| enumeration | HI |
| enumeration | HJ |
| enumeration | HK |
| enumeration | HL |
| enumeration | HM |
| enumeration | HN |
| enumeration | HO |
| enumeration | HP |
| enumeration | HQ |
| enumeration | HR |
| enumeration | HS |
| enumeration | HT |
| enumeration | HU |
| enumeration | HV |
| enumeration | HW |
| enumeration | HX |
| enumeration | HY |
| enumeration | HZ |
| enumeration | IA |
| enumeration | IB |
| enumeration | IC |
| enumeration | ID |
| enumeration | IE |
| enumeration | IF |
| enumeration | IG |
| enumeration | IH |
| enumeration | II |
| enumeration | IJ |
| enumeration | IK |
| enumeration | IL |

| | |
|-------------|----|
| enumeration | IM |
| enumeration | IN |
| enumeration | IO |
| enumeration | IP |
| enumeration | IQ |
| enumeration | IR |
| enumeration | IS |
| enumeration | IT |
| enumeration | IU |
| enumeration | IV |
| enumeration | IW |
| enumeration | IX |
| enumeration | IY |
| enumeration | IZ |
| enumeration | JA |
| enumeration | JB |
| enumeration | JC |
| enumeration | JD |
| enumeration | JE |
| enumeration | JF |
| enumeration | JG |
| enumeration | JH |
| enumeration | JI |
| enumeration | JJ |
| enumeration | JK |
| enumeration | JL |
| enumeration | JM |
| enumeration | JN |
| enumeration | JO |
| enumeration | JP |
| enumeration | JQ |
| enumeration | JR |
| enumeration | JS |
| enumeration | JT |
| enumeration | JU |
| enumeration | JV |
| enumeration | JW |
| enumeration | JX |
| enumeration | JY |
| enumeration | JZ |
| enumeration | KA |
| enumeration | KB |
| enumeration | KC |
| enumeration | KD |
| enumeration | KE |
| enumeration | KF |
| enumeration | KG |
| enumeration | KH |
| enumeration | KI |

| | |
|------------|-------------------------------------------------------------------------------------------------------------------------------------------------------------------------------------------------------------------------------------------------|
| | enumeration KJ enumeration KK enumeration KL enumeration KM enumeration KN enumeration KO enumeration KP enumeration KQ enumeration KR enumeration KS enumeration XA |
| annotation | documentation Specifies error using code from valid set |
| source | <pre><xs:element name="D4004_ReturnCode" type="ReturnCodeType"> <xs:annotation> <xs:documentation>Specifies error using code from valid set</xs:documentation> </xs:annotation> </xs:element></pre> |

element **D4005_CancellationCode**

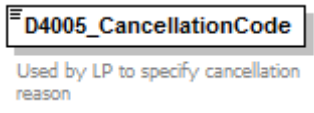
| | |
|------------|-------------------------------------------------------------------------------------------------------------------------------------------------------------------------------------------------------------------------------------------------------------|
| diagram |  |
| namespace | urn:bridgeall-com:cmaservice:data:v3 |
| type | CancellationCodeType |
| properties | content simple |
| used by | complexTypes CancelRegistrationNotificationType CancelRegistrationType |
| facets | Kind Value annotation enumeration S enumeration N enumeration D enumeration C enumeration F |
| annotation | documentation Used by LP to specify cancellation reason |
| source | <pre><xs:element name="D4005_CancellationCode" type="CancellationCodeType"> <xs:annotation> <xs:documentation>Used by LP to specify cancellation reason</xs:documentation> </xs:annotation> </xs:element></pre> |

element **D4006_EffectiveFrom**

| | |
|---------|-------------------------------------------------------------------------------------|
| diagram |  |
|---------|-------------------------------------------------------------------------------------|

| | |
|------------|----------------------------------------------------------------------------------------------------------------------------------------------------------------------------------------------------------------------------------------------------------------------------------------------------------------------------------------------------------------------------------------------------------------------------------------------------------------------------------------------------------------------------------------------------------------------------------------------------------------------------------------------------------------------------------------------------------------------------------------------------------------------------------------------------------------------------------------------------------------------------------------------------------------------------------------------------------------------------------------------------------------------------------------------------------------------------------------------------------------------------------------------------------------------------------------------------------------------------------------------------------------------------------------------------------------------------------------------------------------------------------------------------------------------------------------------------------------------------------------------------------------------------------------|
| namespace | urn:bridgeall-com:cmaservice:data:v3 |
| type | xs:date |
| properties | content simple |
| used by | <p>complexTypes</p> <p>ChargeableMeterUpdateType DisconnectionType DiscontinueDPIDType DPIDNotificationType DPIDUpdateType MeterAssociationType MeterDisAssociationType MeterNetworkAssociationType MeterUpdateNotificationType MeterUpdateType PremisesSpecialArrangementsUpdateNotificationType PremisesSpecialArrangementsUpdateType Schedule3UpdateType ServiceElementUpdateNotificationType SewerageServiceElementUpdateNotificationType SpecialArrangementsUpdateNotificationType SpecialArrangementsUpdateType T012.0_MiscSPIDUpdateType T012.1_ServiceElementUpdateType T012.3_SewerageServiceElementUpdateType T012.7_UpdateLiveRateableValueType T012.8_UpdateLiveRateableValueNotificationType T016.0_UnmeasurableDeclarationType T034.0_VacSchemeApplication T034.1_VacSchemeGracePeriodNotification T034.2_VacSchemeGraceEndNotification T034.3_VacSchemeApplicationNotification T034.4_VacSchemeApplicationConfirmationOrCancellation T034.5_VacSchemeApplicationConfirmationOrCancellationNotification TEUpdateType</p> |
| annotation | <p>documentation</p> <p>Details the date any data may be effective from</p> |
| source | <pre><xs:element name="D4006_EffectiveFrom" type="xs:date"> <xs:annotation> <xs:documentation>Details the date any data may be effective from</xs:documentation> </xs:annotation> </xs:element></pre> |

element D4007_DateOfEvidence

| | |
|------------|-----------------------------------------------------------------------------------------------------------------------------------------------------------------------------------------------------------------------------------------------------------------------------------------------------------------------------------------------------------------------------------------------------|
| diagram |  |
| namespace | urn:bridgeall-com:cmaservice:data:v3 |
| type | xs:date |
| properties | content simple |
| used by | <p>complexTypes</p> <p>T034.0_VacSchemeApplication T034.1_VacSchemeGracePeriodNotification T034.2_VacSchemeGraceEndNotification T034.3_VacSchemeApplicationNotification T034.4_VacSchemeApplicationConfirmationOrCancellation T034.5_VacSchemeApplicationConfirmationOrCancellationNotification</p> |
| annotation | <p>documentation</p> <p>Identifies the date on which evidence to support a T34.0 is compiled.</p> |
| source | <pre><xs:element name="D4007_DateOfEvidence" type="xs:date"> <xs:annotation> <xs:documentation>Identifies the date on which evidence to support a T34.0 is compiled.</xs:documentation> </xs:annotation> </xs:element></pre> |

element **D4008_CryptographicHash**

| | | | | | | | | | | |
|------------|----------------------------------------------------------------------------------------------------------------------------------------------------------------------------------------------------------------------------------------------------------------------------------------------------------------------------------------------------------------------------------------------------------------------------------------------------------------------------------------------------------------------------------------------------------------------------------------------------------------------------------------------------------------------------------------------------------------------------------------|------------|-------|------------|--------|----|--|------------|----------|--|
| diagram |  <p>Will identify the compiled evidence and will serve to provide a fingerprint for that evidence so that any party at any time can confirm the contents of the contemporary version of the evidence. The hash algorithm used to populate this data item must be that specified in the associated D4009 Cryptographic Hash Algorithm.</p> | | | | | | | | | |
| namespace | urn:bridgeall-com:cmaservice:data:v3 | | | | | | | | | |
| type | restriction of xs:hexBinary | | | | | | | | | |
| properties | content simple | | | | | | | | | |
| used by | complexTypes T034.0_VacSchemeApplication T034.3_VacSchemeApplicationNotification | | | | | | | | | |
| facets | <table border="0"> <tr> <td>Kind</td> <td>Value</td> <td>annotation</td> </tr> <tr> <td>length</td> <td>32</td> <td></td> </tr> <tr> <td>whiteSpace</td> <td>collapse</td> <td></td> </tr> </table> | Kind | Value | annotation | length | 32 | | whiteSpace | collapse | |
| Kind | Value | annotation | | | | | | | | |
| length | 32 | | | | | | | | | |
| whiteSpace | collapse | | | | | | | | | |
| annotation | <p>documentation</p> <p>Will identify the compiled evidence and will serve to provide a fingerprint for that evidence so that any party at any time can confirm the contents of the contemporary version of the evidence. The hash algorithm used to populate this data item must be that specified in the associated D4009 Cryptographic Hash Algorithm.</p> | | | | | | | | | |
| source | <pre><xs:element name="D4008_CryptographicHash"> <xs:annotation> <xs:documentation>Will identify the compiled evidence and will serve to provide a fingerprint for that evidence so that any party at any time can confirm the contents of the contemporary version of the evidence. The hash algorithm used to populate this data item must be that specified in the associated D4009 Cryptographic Hash Algorithm.</xs:documentation> </xs:annotation> <xs:simpleType> <xs:restriction base="xs:hexBinary"> <xs:length value="32"/> <xs:whiteSpace value="collapse"/> </xs:restriction> </xs:simpleType> </xs:element></pre> | | | | | | | | | |

element **D4009_CryptographicHashAlgorithm**

| | | | | | | | |
|-------------|---------------------------------------------------------------------------------------------------------------------------------------------------------------------------------------------------------|------------|-------|------------|-------------|--------|--|
| diagram |  <p>Name of the cryptographic hash algorithm used to derive the value of an associated D4008 Cryptographic Hash.</p> | | | | | | |
| namespace | urn:bridgeall-com:cmaservice:data:v3 | | | | | | |
| type | CryptographicHashAlgorithm | | | | | | |
| properties | content simple | | | | | | |
| used by | complexTypes T034.0_VacSchemeApplication T034.3_VacSchemeApplicationNotification | | | | | | |
| facets | <table border="0"> <tr> <td>Kind</td> <td>Value</td> <td>annotation</td> </tr> <tr> <td>enumeration</td> <td>SHA256</td> <td></td> </tr> </table> | Kind | Value | annotation | enumeration | SHA256 | |
| Kind | Value | annotation | | | | | |
| enumeration | SHA256 | | | | | | |
| annotation | <p>documentation</p> <p>Name of the cryptographic hash algorithm used to derive the value of an associated D4008 Cryptographic Hash.</p> | | | | | | |

| | |
|--------|------------------------------------------------------------------------------------------------------------------------------------------------------------------------------------------------------------------------------------------------------------------------------------------------------------------------------------------------|
| source | <pre><xs:element name="D4009_CryptographicHashAlgorithm" type="CryptographicHashAlgorithm"> <xs:annotation> <xs:documentation>Name of the cryptographic hash algorithm used to derive the value of an associated D4008 Cryptographic Hash.</xs:documentation> </xs:annotation> </xs:element></pre> |
|--------|------------------------------------------------------------------------------------------------------------------------------------------------------------------------------------------------------------------------------------------------------------------------------------------------------------------------------------------------|

element D4010_VacancyChangeGracePeriod

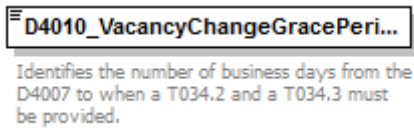
| | |
|------------|----------------------------------------------------------------------------------------------------------------------------------------------------------------------------------------------------------------------------------------------------------------------------------------------------------------------------------|
| diagram |  |
| namespace | urn:bridgeall-com:cmaservice:data:v3 |
| type | xs:nonNegativeInteger |
| properties | content simple |
| used by | complexTypes T034.1_VacSchemeGracePeriodNotification T034.3_VacSchemeApplicationNotification |
| annotation | documentation Identifies the number of business days from the D4007 to when a T034.2 and a T034.3 must be provided. |
| source | <pre><xs:element name="D4010_VacancyChangeGracePeriod" type="xs:nonNegativeInteger"> <xs:annotation> <xs:documentation>Identifies the number of business days from the D4007 to when a T034.2 and a T034.3 must be provided.</xs:documentation> </xs:annotation> </xs:element></pre> |

element D4011_WaterSPLPOrgId

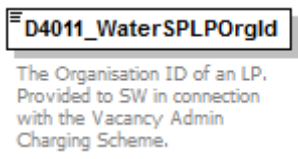
| diagram |  | | | | | | | | | | | | |
|------------|---------------------------------------------------------------------------------------------------------------------------------------------------------------------------------------------------------------------------------------------------------------------------------------------------------|------------|-------|------------|-----------|---|--|-----------|---|--|---------|--------------------------|--|
| namespace | urn:bridgeall-com:cmaservice:data:v3 | | | | | | | | | | | | |
| type | restriction of xs:string | | | | | | | | | | | | |
| properties | content simple | | | | | | | | | | | | |
| used by | complexTypes T034.2_VacSchemeGraceEndNotification T034.3_VacSchemeApplicationNotification | | | | | | | | | | | | |
| facets | <table border="1"> <thead> <tr> <th>Kind</th> <th>Value</th> <th>annotation</th> </tr> </thead> <tbody> <tr> <td>minLength</td> <td>1</td> <td></td> </tr> <tr> <td>maxLength</td> <td>6</td> <td></td> </tr> <tr> <td>pattern</td> <td>([a-z][A-Z][0-9][\-\-])*</td> <td></td> </tr> </tbody> </table> | Kind | Value | annotation | minLength | 1 | | maxLength | 6 | | pattern | ([a-z][A-Z][0-9][\-\-])* | |
| Kind | Value | annotation | | | | | | | | | | | |
| minLength | 1 | | | | | | | | | | | | |
| maxLength | 6 | | | | | | | | | | | | |
| pattern | ([a-z][A-Z][0-9][\-\-])* | | | | | | | | | | | | |
| annotation | documentation The Organisation ID of an LP. Provided to SW in connection with the Vacancy Admin Charging Scheme. | | | | | | | | | | | | |
| source | <pre><xs:element name="D4011_WaterSPLPOrgId"> <xs:annotation> <xs:documentation>The Organisation ID of an LP. Provided to SW in connection with the Vacancy Admin Charging Scheme.</xs:documentation> </xs:annotation> </xs:element></pre> | | | | | | | | | | | | |

| | |
|--|-----------------------------------------------------------------------------------------------------------------------------------------------------------------------------------------------------------------------------------------------------------------------------------------------------------|
| | <pre> </xs:annotation> <xs:simpleType> <xs:restriction base="xs:string"> <xs:minLength value="1"/> <xs:maxLength value="6"/> <xs:pattern value="([a-z][A-Z][0-9][\-\-])*"/> </xs:restriction> </xs:simpleType> </xs:element> </pre> |
|--|-----------------------------------------------------------------------------------------------------------------------------------------------------------------------------------------------------------------------------------------------------------------------------------------------------------|

element D4012_SewerageSPLPOrgId

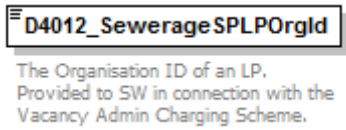
| diagram |  | | | | | | | | | | | | |
|------------|-------------------------------------------------------------------------------------------------------------------------------------------------------------------------------------------------------------------------------------------------------------------------------------------------------------------------------------------------------------------------------------------------------------------------------------------------------------------------------------------------------------------------------------------------------------|------------|-------|------------|-----------|---|--|-----------|---|--|---------|--------------------------|--|
| namespace | urn:bridgeall-com:cmaservice:data:v3 | | | | | | | | | | | | |
| type | restriction of xs:string | | | | | | | | | | | | |
| properties | content simple | | | | | | | | | | | | |
| used by | complexTypes T034.2 VacSchemeGraceEndNotification T034.3 VacSchemeApplicationNotification | | | | | | | | | | | | |
| facets | <table border="1"> <thead> <tr> <th>Kind</th> <th>Value</th> <th>annotation</th> </tr> </thead> <tbody> <tr> <td>minLength</td> <td>1</td> <td></td> </tr> <tr> <td>maxLength</td> <td>6</td> <td></td> </tr> <tr> <td>pattern</td> <td>([a-z][A-Z][0-9][\-\-])*</td> <td></td> </tr> </tbody> </table> | Kind | Value | annotation | minLength | 1 | | maxLength | 6 | | pattern | ([a-z][A-Z][0-9][\-\-])* | |
| Kind | Value | annotation | | | | | | | | | | | |
| minLength | 1 | | | | | | | | | | | | |
| maxLength | 6 | | | | | | | | | | | | |
| pattern | ([a-z][A-Z][0-9][\-\-])* | | | | | | | | | | | | |
| annotation | documentation The Organisation ID of an LP. Provided to SW in connection with the Vacancy Admin Charging Scheme. | | | | | | | | | | | | |
| source | <pre> <xs:element name="D4012_SewerageSPLPOrgId"> <xs:annotation> <xs:documentation>The Organisation ID of an LP. Provided to SW in connection with the Vacancy Admin Charging Scheme.</xs:documentation> </xs:annotation> <xs:simpleType> <xs:restriction base="xs:string"> <xs:minLength value="1"/> <xs:maxLength value="6"/> <xs:pattern value="([a-z][A-Z][0-9][\-\-])*"/> </xs:restriction> </xs:simpleType> </xs:element> </pre> | | | | | | | | | | | | |

element D5001_FreeDescriptor

| diagram |  | | | | | | |
|------------|--------------------------------------------------------------------------------------------------------------------------------------------------------------------------------|------------|-------|------------|-----------|-----|--|
| namespace | urn:bridgeall-com:cmaservice:data:v3 | | | | | | |
| type | restriction of xs:string | | | | | | |
| properties | content simple | | | | | | |
| used by | complexTypes AddressType T004.3 VirtualMeterType | | | | | | |
| facets | <table border="1"> <thead> <tr> <th>Kind</th> <th>Value</th> <th>annotation</th> </tr> </thead> <tbody> <tr> <td>maxLength</td> <td>255</td> <td></td> </tr> </tbody> </table> | Kind | Value | annotation | maxLength | 255 | |
| Kind | Value | annotation | | | | | |
| maxLength | 255 | | | | | | |

| | |
|--------|---------------------------------------------------------------------------------------------------------------------------------------------------------------------------------------------------------------------------------------------------------------------------------------------------------------------------------------------|
| | whiteSpace preserve pattern ([^\t\n\r]*) |
| source | <pre><xs:element name="D5001_FreeDescriptor"> <xs:simpleType> <xs:restriction base="xs:string"> <xs:maxLength value="255"/> <xs:whiteSpace value="preserve"/> <xs:pattern value="([^\t\n\r]*)"/> </xs:restriction> </xs:simpleType> </xs:element></pre> |

element D6001_DPID

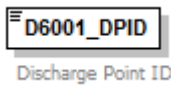
| diagram |  | | | | | | | | | | | | |
|------------|----------------------------------------------------------------------------------------------------------------------------------------------------------------------------------------------------------------------------------------------------------------------------------------------------------|------------|-------|------------|-----------|---|--|-----------|----|--|---------|--------------|--|
| namespace | urn:bridgeall-com:cmaservice:data:v3 | | | | | | | | | | | | |
| type | string32 | | | | | | | | | | | | |
| properties | content simple | | | | | | | | | | | | |
| used by | complexTypes DiscontinueDPIDType DPIDNotificationType DPIDUpdateType DPMeterReadType MeterAssociationType MeterDisAssociationType Schedule3UpdateType TEUpdateType | | | | | | | | | | | | |
| facets | <table border="1"> <thead> <tr> <th>Kind</th> <th>Value</th> <th>annotation</th> </tr> </thead> <tbody> <tr> <td>minLength</td> <td>1</td> <td></td> </tr> <tr> <td>maxLength</td> <td>32</td> <td></td> </tr> <tr> <td>pattern</td> <td>([^\t\n\r]*)</td> <td></td> </tr> </tbody> </table> | Kind | Value | annotation | minLength | 1 | | maxLength | 32 | | pattern | ([^\t\n\r]*) | |
| Kind | Value | annotation | | | | | | | | | | | |
| minLength | 1 | | | | | | | | | | | | |
| maxLength | 32 | | | | | | | | | | | | |
| pattern | ([^\t\n\r]*) | | | | | | | | | | | | |
| annotation | documentation Discharge Point ID | | | | | | | | | | | | |
| source | <pre><xs:element name="D6001_DPID" type="string32"> <xs:annotation> <xs:documentation>Discharge Point ID</xs:documentation> </xs:annotation> </xs:element></pre> | | | | | | | | | | | | |

element D6002_TEVe

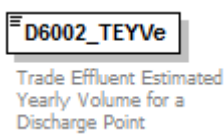
| diagram |  | | | | | | | | | | | | | | | |
|----------------|--------------------------------------------------------------------------------------------------------------------------------------------------------------------------------------------------------------------------------------------------------------------------------------------------------------------------------------------------------------|------------|-------|------------|--------------|---|--|--------------|------------|--|-------------|----|--|----------------|---|--|
| namespace | urn:bridgeall-com:cmaservice:data:v3 | | | | | | | | | | | | | | | |
| type | decimal18 | | | | | | | | | | | | | | | |
| properties | content simple | | | | | | | | | | | | | | | |
| used by | complexTypes DPIDNotificationType DPIDUpdateType | | | | | | | | | | | | | | | |
| facets | <table border="1"> <thead> <tr> <th>Kind</th> <th>Value</th> <th>annotation</th> </tr> </thead> <tbody> <tr> <td>minInclusive</td> <td>0</td> <td></td> </tr> <tr> <td>maxInclusive</td> <td>9999999999</td> <td></td> </tr> <tr> <td>totalDigits</td> <td>18</td> <td></td> </tr> <tr> <td>fractionDigits</td> <td>8</td> <td></td> </tr> </tbody> </table> | Kind | Value | annotation | minInclusive | 0 | | maxInclusive | 9999999999 | | totalDigits | 18 | | fractionDigits | 8 | |
| Kind | Value | annotation | | | | | | | | | | | | | | |
| minInclusive | 0 | | | | | | | | | | | | | | | |
| maxInclusive | 9999999999 | | | | | | | | | | | | | | | |
| totalDigits | 18 | | | | | | | | | | | | | | | |
| fractionDigits | 8 | | | | | | | | | | | | | | | |
| annotation | documentation | | | | | | | | | | | | | | | |

| | |
|--------|--------------------------------------------------------------------------------------------------------------------------------------------------------------------------------------------------------------------------------------------------------------|
| | Trade Effluent Estimated Yearly Volume for a Discharge Point |
| source | <pre><xs:element name="D6002_TeYVe" type="decimal18"> <xs:annotation> <xs:documentation>Trade Effluent Estimated Yearly Volume for a Discharge Point</xs:documentation> </xs:annotation> </xs:element></pre> |

element D6003_CDV

| diagram |  | | | | | | | | | | | | | | | |
|----------------|--------------------------------------------------------------------------------------------------------------------------------------------------------------------------------------------------------------------------------------------------------------------------------------------------------------------------------------------------------------|------------|-------|------------|--------------|---|--|--------------|------------|--|-------------|----|--|----------------|---|--|
| namespace | urn:bridgeall-com:cmaservice:data:v3 | | | | | | | | | | | | | | | |
| type | decimal18 | | | | | | | | | | | | | | | |
| properties | content simple | | | | | | | | | | | | | | | |
| used by | complexType DPIDNotificationType DPIDUpdateType | | | | | | | | | | | | | | | |
| facets | <table border="1"> <thead> <tr> <th>Kind</th> <th>Value</th> <th>annotation</th> </tr> </thead> <tbody> <tr> <td>minInclusive</td> <td>0</td> <td></td> </tr> <tr> <td>maxInclusive</td> <td>9999999999</td> <td></td> </tr> <tr> <td>totalDigits</td> <td>18</td> <td></td> </tr> <tr> <td>fractionDigits</td> <td>8</td> <td></td> </tr> </tbody> </table> | Kind | Value | annotation | minInclusive | 0 | | maxInclusive | 9999999999 | | totalDigits | 18 | | fractionDigits | 8 | |
| Kind | Value | annotation | | | | | | | | | | | | | | |
| minInclusive | 0 | | | | | | | | | | | | | | | |
| maxInclusive | 9999999999 | | | | | | | | | | | | | | | |
| totalDigits | 18 | | | | | | | | | | | | | | | |
| fractionDigits | 8 | | | | | | | | | | | | | | | |
| annotation | documentation TE Availability data: Chargeable Daily Volume m3 | | | | | | | | | | | | | | | |
| source | <pre><xs:element name="D6003_CDV" type="decimal18"> <xs:annotation> <xs:documentation>TE Availability data: Chargeable Daily Volume m3</xs:documentation> </xs:annotation> </xs:element></pre> | | | | | | | | | | | | | | | |

element D6004_sBODL

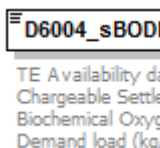
| diagram |  | | | | | | | | | | | | | | | |
|----------------|--------------------------------------------------------------------------------------------------------------------------------------------------------------------------------------------------------------------------------------------------------------------------------------------------------------------------------------------------------------|------------|-------|------------|--------------|---|--|--------------|------------|--|-------------|----|--|----------------|---|--|
| namespace | urn:bridgeall-com:cmaservice:data:v3 | | | | | | | | | | | | | | | |
| type | decimal18 | | | | | | | | | | | | | | | |
| properties | content simple | | | | | | | | | | | | | | | |
| used by | complexType DPIDNotificationType DPIDUpdateType | | | | | | | | | | | | | | | |
| facets | <table border="1"> <thead> <tr> <th>Kind</th> <th>Value</th> <th>annotation</th> </tr> </thead> <tbody> <tr> <td>minInclusive</td> <td>0</td> <td></td> </tr> <tr> <td>maxInclusive</td> <td>9999999999</td> <td></td> </tr> <tr> <td>totalDigits</td> <td>18</td> <td></td> </tr> <tr> <td>fractionDigits</td> <td>8</td> <td></td> </tr> </tbody> </table> | Kind | Value | annotation | minInclusive | 0 | | maxInclusive | 9999999999 | | totalDigits | 18 | | fractionDigits | 8 | |
| Kind | Value | annotation | | | | | | | | | | | | | | |
| minInclusive | 0 | | | | | | | | | | | | | | | |
| maxInclusive | 9999999999 | | | | | | | | | | | | | | | |
| totalDigits | 18 | | | | | | | | | | | | | | | |
| fractionDigits | 8 | | | | | | | | | | | | | | | |
| annotation | documentation TE Availability data: Chargeable Settled Biochemical Oxygen Demand load (kg/day) | | | | | | | | | | | | | | | |

| | |
|--------|----------------------------------------------------------------------------------------------------------------------------------------------------------------------------------------------------------------------------------------------------------------------------------|
| source | <pre><xs:element name="D6004_sBODL" type="decimal18"> <xs:annotation> <xs:documentation>TE Availability data: Chargeable Settled Biochemical Oxygen Demand load (kg/day)</xs:documentation> </xs:annotation> </xs:element></pre> |
|--------|----------------------------------------------------------------------------------------------------------------------------------------------------------------------------------------------------------------------------------------------------------------------------------|

element D6005_TSSL

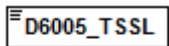
| diagram |  <p>TE Availability data: Chargeable Total Suspended Solids load (kg/day)</p> | | | | | | | | | | | | | | | |
|----------------|--------------------------------------------------------------------------------------------------------------------------------------------------------------------------------------------------------------------------------------------------------------------------------------------------------------------------------------------------------------|------------|-------|------------|--------------|---|--|--------------|------------|--|-------------|----|--|----------------|---|--|
| namespace | urn:bridgeall-com:cmaservice:data:v3 | | | | | | | | | | | | | | | |
| type | decimal18 | | | | | | | | | | | | | | | |
| properties | content simple | | | | | | | | | | | | | | | |
| used by | complexTypees DPIDNotificationType DPIDUpdateType | | | | | | | | | | | | | | | |
| facets | <table border="1"> <thead> <tr> <th>Kind</th> <th>Value</th> <th>annotation</th> </tr> </thead> <tbody> <tr> <td>minInclusive</td> <td>0</td> <td></td> </tr> <tr> <td>maxInclusive</td> <td>9999999999</td> <td></td> </tr> <tr> <td>totalDigits</td> <td>18</td> <td></td> </tr> <tr> <td>fractionDigits</td> <td>8</td> <td></td> </tr> </tbody> </table> | Kind | Value | annotation | minInclusive | 0 | | maxInclusive | 9999999999 | | totalDigits | 18 | | fractionDigits | 8 | |
| Kind | Value | annotation | | | | | | | | | | | | | | |
| minInclusive | 0 | | | | | | | | | | | | | | | |
| maxInclusive | 9999999999 | | | | | | | | | | | | | | | |
| totalDigits | 18 | | | | | | | | | | | | | | | |
| fractionDigits | 8 | | | | | | | | | | | | | | | |
| annotation | documentation TE Availability data: Chargeable Total Suspended Solids load (kg/day) | | | | | | | | | | | | | | | |
| source | <pre><xs:element name="D6005_TSSL" type="decimal18"> <xs:annotation> <xs:documentation>TE Availability data: Chargeable Total Suspended Solids load (kg/day)</xs:documentation> </xs:annotation> </xs:element></pre> | | | | | | | | | | | | | | | |

element D6006_Ot

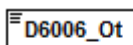
| diagram |  <p>TE Operating Data: Fixed Strength Chemical Oxygen Demand</p> | | | | | | | | | | | | | | | |
|----------------|--------------------------------------------------------------------------------------------------------------------------------------------------------------------------------------------------------------------------------------------------------------------------------------------------------------------------------------------------------------|------------|-------|------------|--------------|---|--|--------------|------------|--|-------------|----|--|----------------|---|--|
| namespace | urn:bridgeall-com:cmaservice:data:v3 | | | | | | | | | | | | | | | |
| type | decimal18 | | | | | | | | | | | | | | | |
| properties | content simple | | | | | | | | | | | | | | | |
| used by | complexTypees DPIDNotificationType TEUpdateType | | | | | | | | | | | | | | | |
| facets | <table border="1"> <thead> <tr> <th>Kind</th> <th>Value</th> <th>annotation</th> </tr> </thead> <tbody> <tr> <td>minInclusive</td> <td>0</td> <td></td> </tr> <tr> <td>maxInclusive</td> <td>9999999999</td> <td></td> </tr> <tr> <td>totalDigits</td> <td>18</td> <td></td> </tr> <tr> <td>fractionDigits</td> <td>8</td> <td></td> </tr> </tbody> </table> | Kind | Value | annotation | minInclusive | 0 | | maxInclusive | 9999999999 | | totalDigits | 18 | | fractionDigits | 8 | |
| Kind | Value | annotation | | | | | | | | | | | | | | |
| minInclusive | 0 | | | | | | | | | | | | | | | |
| maxInclusive | 9999999999 | | | | | | | | | | | | | | | |
| totalDigits | 18 | | | | | | | | | | | | | | | |
| fractionDigits | 8 | | | | | | | | | | | | | | | |
| annotation | documentation TE Operating Data: Fixed Strength Chemical Oxygen Demand | | | | | | | | | | | | | | | |
| source | <pre><xs:element name="D6006_Ot" type="decimal18"> <xs:annotation></pre> | | | | | | | | | | | | | | | |

| | |
|--|-----------------------------------------------------------------------------------------------------------------------------------------------------------------|
| | <pre><xs:documentation>TE Operating Data: Fixed Strength Chemical Oxygen Demand</xs:documentation> </xs:annotation> </xs:element></pre> |
|--|-----------------------------------------------------------------------------------------------------------------------------------------------------------------|

element D6007_St

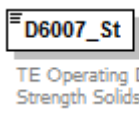
| diagram |  | | | | | | | | | | | | | | | |
|----------------|--------------------------------------------------------------------------------------------------------------------------------------------------------------------------------------------------------------------------------------------------------------------------------------------------------------------------------------------------------------|------------|-------|------------|--------------|---|--|--------------|------------|--|-------------|----|--|----------------|---|--|
| namespace | urn:bridgeall-com:cmaservice:data:v3 | | | | | | | | | | | | | | | |
| type | decimal18 | | | | | | | | | | | | | | | |
| properties | content simple | | | | | | | | | | | | | | | |
| used by | complexTypees DPIDNotificationType TEUpdateType | | | | | | | | | | | | | | | |
| facets | <table border="1"> <thead> <tr> <th>Kind</th> <th>Value</th> <th>annotation</th> </tr> </thead> <tbody> <tr> <td>minInclusive</td> <td>0</td> <td></td> </tr> <tr> <td>maxInclusive</td> <td>9999999999</td> <td></td> </tr> <tr> <td>totalDigits</td> <td>18</td> <td></td> </tr> <tr> <td>fractionDigits</td> <td>8</td> <td></td> </tr> </tbody> </table> | Kind | Value | annotation | minInclusive | 0 | | maxInclusive | 9999999999 | | totalDigits | 18 | | fractionDigits | 8 | |
| Kind | Value | annotation | | | | | | | | | | | | | | |
| minInclusive | 0 | | | | | | | | | | | | | | | |
| maxInclusive | 9999999999 | | | | | | | | | | | | | | | |
| totalDigits | 18 | | | | | | | | | | | | | | | |
| fractionDigits | 8 | | | | | | | | | | | | | | | |
| annotation | documentation TE Operating Data: Fixed Strength Solids Demand | | | | | | | | | | | | | | | |
| source | <pre><xs:element name="D6007_St" type="decimal18"> <xs:annotation> <xs:documentation>TE Operating Data: Fixed Strength Solids Demand</xs:documentation> </xs:annotation> </xs:element></pre> | | | | | | | | | | | | | | | |

element D6009_Non-domesticAllowance

| diagram |  | | | | | | | | | |
|--------------|------------------------------------------------------------------------------------------------------------------------------------------------------------------------------------------------------------------------------------------------------------------------------------------------------------------------------------------------------------------------------------------------------------------|------------|-------|------------|--------------|---|--|--------------|------------|--|
| namespace | urn:bridgeall-com:cmaservice:data:v3 | | | | | | | | | |
| type | restriction of xs:integer | | | | | | | | | |
| properties | content simple | | | | | | | | | |
| used by | complexTypees DPIDNotificationType DPIDUpdateType | | | | | | | | | |
| facets | <table border="1"> <thead> <tr> <th>Kind</th> <th>Value</th> <th>annotation</th> </tr> </thead> <tbody> <tr> <td>minInclusive</td> <td>0</td> <td></td> </tr> <tr> <td>maxInclusive</td> <td>9999999999</td> <td></td> </tr> </tbody> </table> | Kind | Value | annotation | minInclusive | 0 | | maxInclusive | 9999999999 | |
| Kind | Value | annotation | | | | | | | | |
| minInclusive | 0 | | | | | | | | | |
| maxInclusive | 9999999999 | | | | | | | | | |
| annotation | documentation Annual volume associated with the foul sewerage for the Discharge Point (m3) | | | | | | | | | |
| source | <pre><xs:element name="D6009_Non-domesticAllowance"> <xs:annotation> <xs:documentation>Annual volume associated with the foul sewerage for the Discharge Point (m3)</xs:documentation> </xs:annotation> <xs:simpleType> <xs:restriction base="xs:integer"> <xs:minInclusive value="0"/> </xs:restriction> </xs:simpleType> </xs:element></pre> | | | | | | | | | |

| | |
|--|----------------------------------------------------------------------------------------------------------------------------|
| | <pre> <xs:maxInclusive value="999999999"/> </xs:restriction> </xs:simpleType> </xs:element> </pre> |
|--|----------------------------------------------------------------------------------------------------------------------------|

element D6010_SDTIndicator

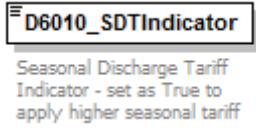
| | |
|------------|---------------------------------------------------------------------------------------------------------------------------------------------------------------------------------------------------------------------------------------------------------------------------------------------|
| diagram |  |
| namespace | urn:bridgeall-com:cmaservice:data:v3 |
| type | xs:boolean |
| properties | content simple |
| used by | complexType DPIDNotificationType DPIDUpdateType |
| annotation | documentation Seasonal Discharge Tariff Indicator - set as True to apply higher seasonal tariff |
| source | <pre> <xs:element name="D6010_SDTIndicator" type="xs:boolean"> <xs:annotation> <xs:documentation>Seasonal Discharge Tariff Indicator - set as True to apply higher seasonal tariff</xs:documentation> </xs:annotation> </xs:element> </pre> |

element D6011_TETreatment

| | | | | | | | | | | | | | |
|-------------|--------------------------------------------------------------------------------------------------------------------------------------------------------------------------------------------------------------------------------------------------------------------------------|------------|-------|------------|-------------|-----------|--|-------------|---------|--|-------------|-------------|--|
| diagram |  | | | | | | | | | | | | |
| namespace | urn:bridgeall-com:cmaservice:data:v3 | | | | | | | | | | | | |
| type | TETreatmentType | | | | | | | | | | | | |
| properties | content simple | | | | | | | | | | | | |
| used by | complexType DPIDNotificationType | | | | | | | | | | | | |
| facets | <table border="0"> <tr> <td>Kind</td> <td>Value</td> <td>annotation</td> </tr> <tr> <td>enumeration</td> <td>Secondary</td> <td></td> </tr> <tr> <td>enumeration</td> <td>Primary</td> <td></td> </tr> <tr> <td>enumeration</td> <td>Sub-Primary</td> <td></td> </tr> </table> | Kind | Value | annotation | enumeration | Secondary | | enumeration | Primary | | enumeration | Sub-Primary | |
| Kind | Value | annotation | | | | | | | | | | | |
| enumeration | Secondary | | | | | | | | | | | | |
| enumeration | Primary | | | | | | | | | | | | |
| enumeration | Sub-Primary | | | | | | | | | | | | |
| annotation | documentation TETreatment indicator | | | | | | | | | | | | |
| source | <pre> <xs:element name="D6011_TETreatment" type="TETreatmentType"> <xs:annotation> <xs:documentation>TETreatment indicator</xs:documentation> </xs:annotation> </xs:element> </pre> | | | | | | | | | | | | |

element D6012_PcentAllowance

| | |
|---------|-------------------------------------------------------------------------------------|
| diagram |  |
|---------|-------------------------------------------------------------------------------------|

| namespace | urn:bridgeall-com:cmaservice:data:v3 | | | | | | | | | | | | | | | |
|----------------|------------------------------------------------------------------------------------------------------------------------------------------------------------------------------------------------------------------------------------------------------------------------------------------------------------------------------------------------------|------------|-------|------------|--------------|---|--|--------------|-----|--|-------------|---|--|----------------|---|--|
| type | percentage | | | | | | | | | | | | | | | |
| properties | content simple | | | | | | | | | | | | | | | |
| used by | complexTypees DPIDNotificationType DPIDUpdateType | | | | | | | | | | | | | | | |
| facets | <table border="1"> <thead> <tr> <th>Kind</th> <th>Value</th> <th>annotation</th> </tr> </thead> <tbody> <tr> <td>minInclusive</td> <td>0</td> <td></td> </tr> <tr> <td>maxInclusive</td> <td>100</td> <td></td> </tr> <tr> <td>totalDigits</td> <td>5</td> <td></td> </tr> <tr> <td>fractionDigits</td> <td>2</td> <td></td> </tr> </tbody> </table> | Kind | Value | annotation | minInclusive | 0 | | maxInclusive | 100 | | totalDigits | 5 | | fractionDigits | 2 | |
| Kind | Value | annotation | | | | | | | | | | | | | | |
| minInclusive | 0 | | | | | | | | | | | | | | | |
| maxInclusive | 100 | | | | | | | | | | | | | | | |
| totalDigits | 5 | | | | | | | | | | | | | | | |
| fractionDigits | 2 | | | | | | | | | | | | | | | |
| annotation | documentation DPID Percentage Allowance | | | | | | | | | | | | | | | |
| source | <pre><xs:element name="D6012_PcentAllowance" type="percentage"> <xs:annotation> <xs:documentation>DPID Percentage Allowance</xs:documentation> </xs:annotation> </xs:element></pre> | | | | | | | | | | | | | | | |

element **D6013_FixedAllowance**

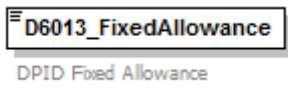
| | |
|------------|---------------------------------------------------------------------------------------------------------------------------------------------------------------------------------------------------------------------------------------|
| diagram |  |
| namespace | urn:bridgeall-com:cmaservice:data:v3 |
| type | xs:nonNegativeInteger |
| properties | content simple |
| used by | complexTypees DPIDNotificationType DPIDUpdateType |
| annotation | documentation DPID Fixed Allowance |
| source | <pre><xs:element name="D6013_FixedAllowance" type="xs:nonNegativeInteger"> <xs:annotation> <xs:documentation>DPID Fixed Allowance</xs:documentation> </xs:annotation> </xs:element></pre> |

element **Document**

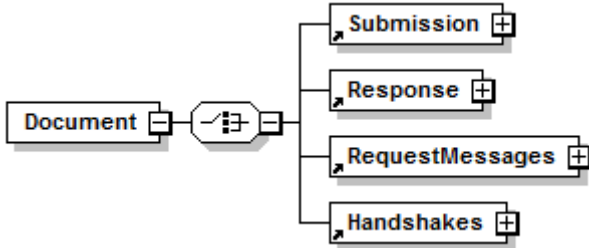
| | |
|------------|----------------------------------------------------------------------------------------------------------------|
| diagram |  |
| namespace | urn:bridgeall-com:cmaservice:data:v3 |
| properties | content complex |
| children | Submission Response RequestMessages Handshakes |
| source | <pre><xs:element name="Document"> <xs:complexType></pre> |

| | |
|--|--------------------------------------------------------------------------------------------------------------------------------------------------------------------------------------------------------------------------------------------------------------|
| | <pre> <xs:choice> <xs:element ref="Submission"/> <xs:element ref="Response"/> <xs:element ref="RequestMessages"/> <xs:element ref="Handshakes"/> </xs:choice> </xs:complexType> </xs:element> </pre> |
|--|--------------------------------------------------------------------------------------------------------------------------------------------------------------------------------------------------------------------------------------------------------------|

element Handshakes

| | | | | | | |
|------------|-------------------------------------------------------------------------------------------------------------------------------------------------------------------------------------------------------------------------------------------------------------------------------------------------------------------------------------------------------------------------------------------------------------------------------------------------------------------------------------------------------------------------------------------------------------------------------------------------------------------------------------------------------------------------------|------|----------|---------|-------|------------|
| diagram | | | | | | |
| namespace | urn:bridgeall-com:cmaservice:data:v3 | | | | | |
| properties | content complex | | | | | |
| children | HandShake | | | | | |
| used by | element Document | | | | | |
| attributes | Name | Type | Use | Default | Fixed | annotation |
| | D1005_SenderOrgID | | required | | | |
| source | <pre> <xs:element name="Handshakes"> <xs:complexType> <xs:sequence maxOccurs="unbounded"> <xs:element name="HandShake"> <xs:complexType> <xs:attribute name="D1003_FlowReference" type="xs:string" use="required"/> <xs:attribute name="MessageCount" type="xs:int" use="optional"/> <xs:attribute name="XMLDocLength" type="xs:int" use="optional"/> </xs:complexType> </xs:element> </xs:sequence> <xs:attribute name="D1005_SenderOrgID" use="required"/> </xs:complexType> </xs:element> </pre> | | | | | |

attribute Handshakes/@D1005_SenderOrgID

| | |
|------------|--------------------------------------------------------------------------|
| properties | isRef 0 use required |
| source | <pre><xs:attribute name="D1005_SenderOrgID" use="required"/></pre> |

element **Handshakes/HandShake**

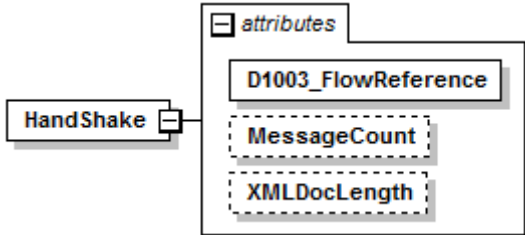
| | | | | | | |
|------------|------------------------------------------------------------------------------------------------------------------------------------------------------------------------------------------------------------------------------------------------------------------------------------------------------------------------------------------------------------------|-----------|----------|---------|-------|------------|
| diagram |  | | | | | |
| namespace | urn:bridgeall-com:cmaservice:data:v3 | | | | | |
| properties | isRef | 0 | content | complex | | |
| attributes | Name | Type | Use | Default | Fixed | annotation |
| | D1003_FlowReference | xs:string | required | | | |
| | MessageCount | xs:int | optional | | | |
| | XMLDocLength | xs:int | optional | | | |
| source | <pre><xs:element name="HandShake"> <xs:complexType> <xs:attribute name="D1003_FlowReference" type="xs:string" use="required"/> <xs:attribute name="MessageCount" type="xs:int" use="optional"/> <xs:attribute name="XMLDocLength" type="xs:int" use="optional"/> </xs:complexType> </xs:element></pre> | | | | | |

attribute **Handshakes/HandShake/@D1003_FlowReference**

| | |
|------------|---------------------------------------------------------------------------------------------|
| type | xs:string |
| properties | isRef 0 use required |
| source | <pre><xs:attribute name="D1003_FlowReference" type="xs:string" use="required"/></pre> |

attribute **Handshakes/HandShake/@MessageCount**

| | |
|------------|-----------------------------------------------------------------------------------|
| type | xs:int |
| properties | isRef 0 use optional |
| source | <pre><xs:attribute name="MessageCount" type="xs:int" use="optional"/></pre> |

attribute **Handshakes/HandShake/@XMLDocLength**

| | |
|------------|-----------------------------------------------------------------------------------|
| type | xs:int |
| properties | isRef 0 use optional |
| source | <pre><xs:attribute name="XMLDocLength" type="xs:int" use="optional"/></pre> |

element Messages

| | |
|------------------|--------------------------------------------------------------------------------------------------------------------------------------------------------------------------------------------------------------------------------------------------------------------------------------------------------------------------------------------------------------------------------------------------------------------------------------------------------------------------------------------------------------------------------------------------------------------------------------------------------------------------------------------------------------------------------------------------------------------------------------------------------------------------------------------------------------------------------------------------------------------------------------------------------------------------------------------------------------------------------------------------------------------------------------------------------------------------------------------------------------------------------------------------------------------------------------------------------------------------------------------------------------------------------------------------------------------------------------------------------------------------------------------------------------------------------------------------------------------------------------------------------------------------------------------------------------------------------------------------------------------------------------------------------------------------------------------------------------------------------------------------------------------------------------------------------------------------------------------------------------------------------------------------------------------------------------------------------------------------------------------------------------------------------------------------------------------------------------------------------------------------|
| <p>diagram</p> | <p>The diagram shows a vertical list of message types under the heading 'MessagesType'. Each message type is represented by a small box with a plus icon. The list includes:</p> <ul style="list-style-type: none"> T001.0_NewSPIDRequests T003.0_PartialRegistrationAppli... T003.1_RegistrationApplications T004.0_NewMeters T004.2_LPMeterUpdates T004.3_VirtualMeters T005.0_SWMeterReads T005.1_LPMeterReads T006.0_LPWaterSPIDUpdates T006.1_LPSewerageSPIDUpdates T006.2_WaterSPIDUpdates T006.3_SewerageSPIDUpdates T006.6_ProvideLiveRateableVal... T007.0_WaterConnectionCompl... T007.1_SewerageConnectionC... T009.2_Notifications T009.3_Notifications T010.0_CancelRegistrationInco... T010.1_CancelRegistrationOutg... T012.0_MiscSPIDUpdates T012.1_ServiceElementUpdates T012.3_SewerageServiceEleme... T012.5_UpdateSAAREferenceNu... T012.7_UpdateLiveRateableValu... T013.0_MeterUpdates T013.2_UpdateMeterLocations T014.0_ChargeableMeterUpdates T015.0_DisconnectionDeclaratio... T016.0_UnmeasurableDeclarat... T017.0_Meter Swaps T021.0_NewDPIDs T022.0_TEUpdates T023.0_MeterAssociations T024.0_MeterDisAssociations T026.0_DiscontinueDPIDs T027.0_DPIDUpdates T028.1_Schedule3Updates T029.1_SpecialArrangementsU... T029.3_PremisesSpecialArrang... T032.0_CreateUpdateCustomer... T033.0_MeteredBuildings T034.0_VacSchemeApplications T034.4_VacSchemeApplication... T036.0_MeterNetworkAssociati... <p>At the bottom of the list is a 'constraints' section with a 'unique' constraint:</p> <ul style="list-style-type: none"> unique UniqueMessageID <ul style="list-style-type: none"> selector */* field @MID |
| <p>namespace</p> | <p>urn:bridgeall-com:cmaservice:data:v3</p> |
| <p>type</p> | <p>MessagesType</p> |

| properties | content complex | | | | | | | | |
|----------------------|--------------------------------------------------------------------------------------------------------------------------------------------------------------------------------------------------------------------------------------------------------------------------------------------------------------------------------------------------------------------------------------------------------------------------------------------------------------------------------------------------------------------------------------------------------------------------------------------------------------------------------------------------------------------------------------------------------------------------------------------------------------------------------------------------------------------------------------------------------------------------------------------------------------------------------------------------------------------------------------------------------------------------------------------------------------------------------------------------------------------------------------------------------------------------------------------------------------------------------------------------------------------------------------------------------------------------------------------------------------------------------------------------------------------------------------------------------------------------------------------------------------------------------------------------------------------------------------------------------------------------------------------------------------------------------------------------------------------------------------------------------------------------------------------------------------------------------------------------------------------------------------------------------------------------------------------------------------------------------------------------------------------------------------------------------------------|----------|----------|----------|----------|--------|-----------------|-----|------|
| children | T001.0 NewSPIDRequests T003.0 PartialRegistrationApplications T003.1 RegistrationApplications T004.0 NewMeters T004.2 LPMeterUpdates T004.3 VirtualMeters T005.0 SWMeterReads T005.1 LPMeterReads T006.0 LPWaterSPIDUpdates T006.1 LPsewerageSPIDUpdates T006.2 WaterSPIDUpdates T006.3 SewerageSPIDUpdates T006.6 ProvideLiveRateableValues T007.0 WaterConnectionCompletes T007.1 SewerageConnectionCompletes T009.2 Notifications T009.3 Notifications T010.0 CancelRegistrationIncomings T010.1 CancelRegistrationOutgoings T012.0 MiscSPIDUpdates T012.1 ServiceElementUpdates T012.3 SewerageServiceElementUpdates T012.5 UpdateSAReferenceNumberUPRNs T012.7 UpdateLiveRateableValues T013.0 MeterUpdates T013.2 UpdateMeterLocations T014.0 ChargeableMeterUpdates T015.0 DisconnectionDeclarations T016.0 UnmeasureableDeclarations T017.0 MeterSwaps T021.0 NewDPIDs T022.0 TEUpdates T023.0 MeterAssociations T024.0 MeterDisAssociations T026.0 DiscontinueDPIDs T027.0 DPIDUpdates T028.1 Schedule3Updates T029.1 SpecialArrangementsUpdates T029.3 PremisesSpecialArrangementsUpdates T032.0 CreateUpdateCustomerName T033.0 MeteredBuildings T034.0 VacSchemeApplications T034.4 VacSchemeApplicationConfirmationOrCancellations T036.0 MeterNetworkAssociations | | | | | | | | |
| used by | element Submission | | | | | | | | |
| identity constraints | <table border="1"> <thead> <tr> <th>Name</th> <th>Refer</th> <th>Selector</th> <th>Field(s)</th> </tr> </thead> <tbody> <tr> <td>unique</td> <td>UniqueMessageID</td> <td>*/*</td> <td>@MID</td> </tr> </tbody> </table> | Name | Refer | Selector | Field(s) | unique | UniqueMessageID | */* | @MID |
| Name | Refer | Selector | Field(s) | | | | | | |
| unique | UniqueMessageID | */* | @MID | | | | | | |
| source | <pre><xs:element name="Messages" type="MessagesType"> <xs:unique name="UniqueMessageID"> <xs:selector xpath="*/*/"> <xs:field xpath="@MID"/> </xs:unique> </xs:element></pre> | | | | | | | | |

element RequestMessages

| diagram | | | | | | | | | | | | | |
|-----------------------------------|-------------------------------------------------------------------------------------------------------------------------------------------------------------------------------------------------------------------------------------------------------------------------------------------------------------------------------------------------------------------------------------------------------------------------------------------------------------------|----------|---------|-------|------------|-------|------------|-----------------------------------|--|----------|--|--|--|
| namespace | urn:bridgeall-com:cmaservice:data:v3 | | | | | | | | | | | | |
| properties | content complex | | | | | | | | | | | | |
| children | NewMessages | | | | | | | | | | | | |
| used by | element Document | | | | | | | | | | | | |
| attributes | <table border="1"> <thead> <tr> <th>Name</th> <th>Type</th> <th>Use</th> <th>Default</th> <th>Fixed</th> <th>annotation</th> </tr> </thead> <tbody> <tr> <td>D1005_SenderOrgID</td> <td></td> <td>required</td> <td></td> <td></td> <td></td> </tr> </tbody> </table> | Name | Type | Use | Default | Fixed | annotation | D1005_SenderOrgID | | required | | | |
| Name | Type | Use | Default | Fixed | annotation | | | | | | | | |
| D1005_SenderOrgID | | required | | | | | | | | | | | |
| source | <pre><xs:element name="RequestMessages"> <xs:complexType> <xs:choice> <xs:element name="NewMessages"> <xs:complexType> <xs:attribute name="MaxMessages" type="xs:short" use="required"/> </xs:complexType> </xs:element> </xs:choice> <xs:attribute name="D1005_SenderOrgID" use="required"/> </xs:complexType> </xs:element></pre> | | | | | | | | | | | | |

attribute RequestMessages/@D1005_SenderOrgID

| | |
|------------|---------------------------------------------------------|
| properties | isRef 0 use required |
| source | <xs:attribute name="D1005_SenderOrgID" use="required"/> |

element RequestMessages/NewMessages

| | | | | | | |
|------------|-----------------------------------------------------------------------------------------------------------------------------------------------------------------------------------------------------|------------------|-----------------|---------|-------|------------|
| diagram | <p>The diagram shows a box labeled 'NewMessages' with a smaller box labeled 'attributes' attached to its right side. Inside the 'attributes' box is a box labeled 'MaxMessages'.</p> | | | | | |
| namespace | urn:bridgeall-com:cmaservice:data:v3 | | | | | |
| properties | isRef 0 content complex | | | | | |
| attributes | Name MaxMessages | Type xs:short | Use required | Default | Fixed | annotation |
| source | <pre><xs:element name="NewMessages"> <xs:complexType> <xs:attribute name="MaxMessages" type="xs:short" use="required"/> </xs:complexType> </xs:element></pre> | | | | | |

attribute RequestMessages/NewMessages/@MaxMessages

| | |
|------------|-------------------------------------------------------------------|
| type | xs:short |
| properties | isRef 0 use required |
| source | <xs:attribute name="MaxMessages" type="xs:short" use="required"/> |

element Response

| | | | | | | |
|------------|-------------------------------------------------------------------------------------------------------------------------------------------------------------------------------------------------------------------------------------------------------------------------------------------------------------------|--|--|--|--|--|
| diagram | <p>The diagram shows a box labeled 'Response' with a dashed box labeled 'ResponseMessages' attached to its right side. Above 'ResponseMessages' is a box labeled 'ResponseHeader' with a plus sign in a square, indicating it is a child element.</p> | | | | | |
| namespace | urn:bridgeall-com:cmaservice:data:v3 | | | | | |
| properties | content complex | | | | | |
| children | ResponseHeader ResponseMessages | | | | | |
| used by | element Document | | | | | |
| source | <pre><xs:element name="Response"> <xs:complexType> <xs:sequence> <xs:element name="ResponseHeader" type="TransactionHeaderType"/> <xs:element ref="ResponseMessages" minOccurs="0"/> </xs:sequence> </xs:complexType> </xs:element></pre> | | | | | |

element **Response/ResponseHeader**

| | |
|-------------------|------------------------------------------------------------------------------------------------------------------------------------------------------------------------------------------------------------------------------------------------------------------------------------------------------------------------------------------------------------------------------------------------------------------------------------------------------------------------------------------------------------------------------------------------------------------------------------------------------------|
| <p>diagram</p> | <p>The diagram illustrates the structure of the ResponseHeader element. It is a container for the TransactionHeaderType. TransactionHeaderType contains four elements:</p> <ul style="list-style-type: none"> D1005_SenderOrgId: D1005 Organisation ID of organisation sending data D1006_RecipientOrgId: D1006 Organisation ID of intended recipient of data D1007_TransactionTimestamp: D1007 Timestamp of data flow on send D1003_FlowReference: D1003 Provides a reference ID for flow from originating org |
| <p>namespace</p> | <p>urn:bridgeall-com:cmaservice:data:v3</p> |
| <p>type</p> | <p>TransactionHeaderType</p> |
| <p>properties</p> | <p>isRef 0 content complex</p> |
| <p>children</p> | <p>D1005_SenderOrgId D1006_RecipientOrgId D1007_TransactionTimestamp D1003_FlowReference</p> |
| <p>source</p> | <p><code><xs:element name="ResponseHeader" type="TransactionHeaderType"/></code></p> |

element ResponseMessages

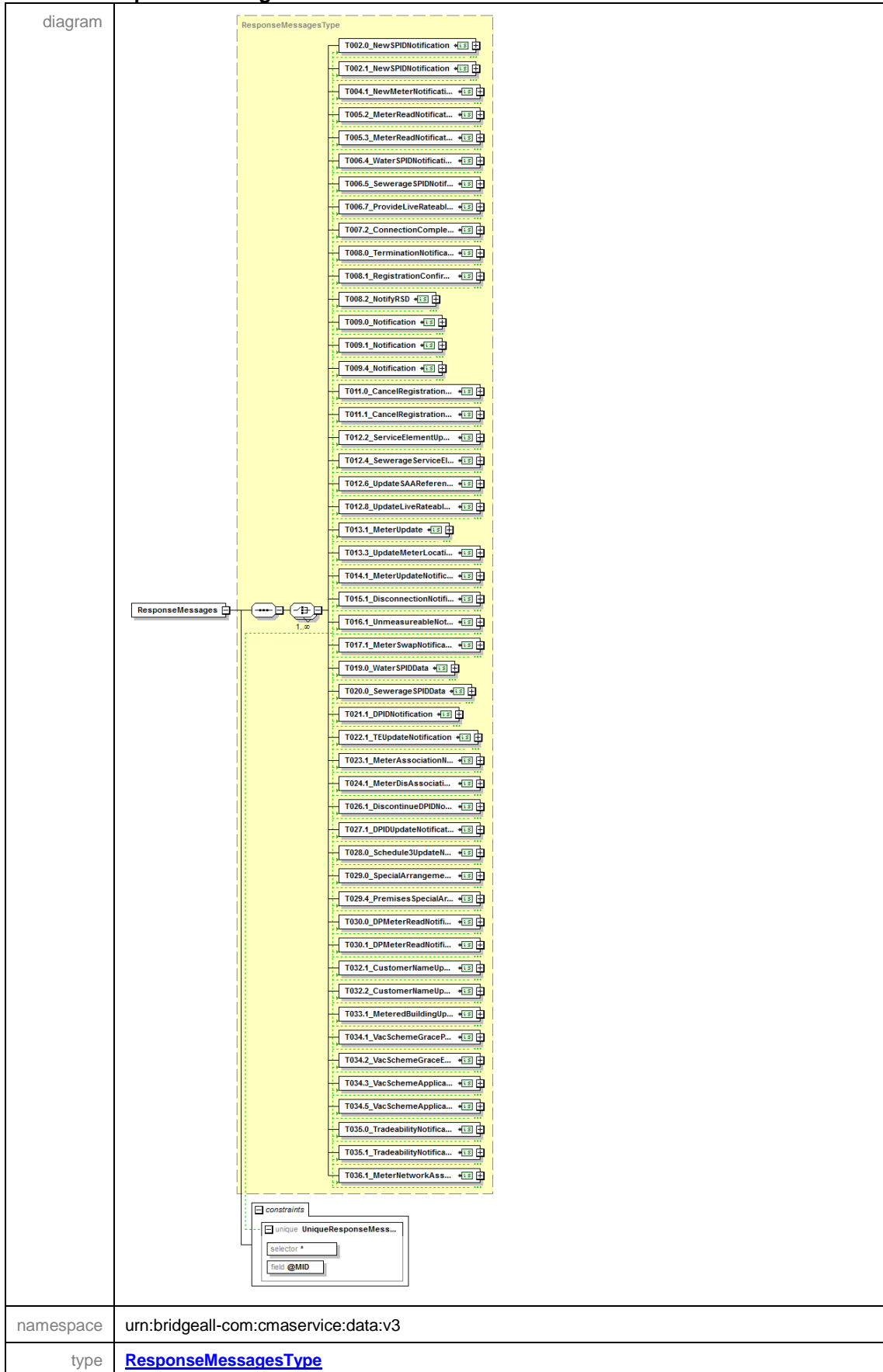

| properties | content complex | | | | | | | | |
|----------------------|-----------------------------------------------------------------------------------------------------------------------------------------------------------------------------------------------------------------------------------------------------------------------------------------------------------------------------------------------------------------------------------------------------------------------------------------------------------------------------------------------------------------------------------------------------------------------------------------------------------------------------------------------------------------------------------------------------------------------------------------------------------------------------------------------------------------------------------------------------------------------------------------------------------------------------------------------------------------------------------------------------------------------------------------------------------------------------------------------------------------------------------------------------------------------------------------------------------------------------------------------------------------------------------------------------------------------------------------------------------------------------------------------------------------------------------------------------------------------------------------------------------------------------------------------------------------------------------------------------------------------------------------------------------------------------------------------------------------------------------------------------------------------------------------------------------------------------------------------------------------------------------------------------------------------------------------------------------------------------------------------------------------------------------------------------------------------------------------------------------------------------------------------------------------------------------------------------------------------------------------------------------------------------------------------------------------------------------------------------------------------------------------------------------------------------------------------------------------------------------------------------------------------------------------------------------------------------------------------|----------|----------|----------|----------|--------|-------------------------|---|------|
| children | T002.0 NewSPIDNotification T002.1 NewSPIDNotification T004.1 NewMeterNotification T005.2 MeterReadNotification T005.3 MeterReadNotification T006.4 WaterSPIDNotification T006.5 SewerageSPIDNotification T006.7 ProvideLiveRateableValueNotification T007.2 ConnectionCompleteNotification T008.0 TerminationNotification T008.1 RegistrationConfirmation T008.2 NotifyRSD T009.0 Notification T009.1 Notification T009.4 Notification T011.0 CancelRegistrationNotificationIncoming T011.1 CancelRegistrationNotificationOutgoing T012.2 ServiceElementUpdateNotification T012.4 SewerageServiceElementUpdateNotification T012.6 UpdateSAAResponseNumberUPRNNotification T012.8 UpdateLiveRateableValueNotification T013.1 MeterUpdate T013.3 UpdateMeterLocationNotification T014.1 MeterUpdateNotification T015.1 DisconnectionNotification T016.1 UnmeasureableNotification T017.1 MeterSwapNotification T019.0 WaterSPIDData T020.0 SewerageSPIDData T021.1 DPIDNotification T022.1 TEUpdateNotification T023.1 MeterAssociationNotification T024.1 MeterDisAssociationNotification T026.1 DiscontinueDPIDNotification T027.1 DPIDUpdateNotification T028.0 Schedule3UpdateNotification T029.0 SpecialArrangementsUpdateNotification T029.4 PremisesSpecialArrangementsUpdateNotification T030.0 DPMeterReadNotification T030.1 DPMeterReadNotification T032.1 CustomerNameUpdated T032.2 CustomerNameUpdatedNotification T033.1 MeteredBuildingUpdate T034.1 VacSchemeGracePeriodNotification T034.2 VacSchemeGraceEndNotification T034.3 VacSchemeApplicationNotification T034.5 VacSchemeApplicationConfirmationOrCancellationNotification T035.0 TradeabilityNotification T035.1 TradeabilityNotification T036.1 MeterNetworkAssociationNotification | | | | | | | | |
| used by | element Response | | | | | | | | |
| identity constraints | <table border="1"> <thead> <tr> <th>Name</th> <th>Refer</th> <th>Selector</th> <th>Field(s)</th> </tr> </thead> <tbody> <tr> <td>unique</td> <td>UniqueResponseMessageID</td> <td>*</td> <td>@MID</td> </tr> </tbody> </table> | Name | Refer | Selector | Field(s) | unique | UniqueResponseMessageID | * | @MID |
| Name | Refer | Selector | Field(s) | | | | | | |
| unique | UniqueResponseMessageID | * | @MID | | | | | | |
| source | <pre><xs:element name="ResponseMessages" type="ResponseMessagesType"> <xs:unique name="UniqueResponseMessageID"> <xs:selector xpath="*/"> <xs:field xpath="@MID"/> </xs:unique> </xs:element></pre> | | | | | | | | |

element **Submission**

| | |
|------------|---------------------------------------------------------------------------------------------------------------------------------------------------------------------------------------------------------------------------------------------------------------------------------------|
| diagram | <pre> classDiagram class Submission { Header Messages } class Header class Messages Submission "1" -- "*" Header Submission "1" -- "*" Messages </pre> |
| namespace | urn:bridgeall-com:cmaservice:data:v3 |
| properties | content complex |
| children | Header Messages |
| used by | element Document |
| source | <pre><xs:element name="Submission"> <xs:complexType> <xs:sequence> <xs:element name="Header" type="TransactionHeaderType"/> <xs:element ref="Messages"/> </xs:sequence> </xs:complexType> </xs:element></pre> |

element **Submission/Header**

| | |
|-------------------|------------------------------------------------------------------------------------------------------------------------------------------------------------------|
| <p>diagram</p> | |
| <p>namespace</p> | <p>urn:bridgeall-com:cmaservice:data:v3</p> |
| <p>type</p> | <p>TransactionHeaderType</p> |
| <p>properties</p> | <p>isRef 0 content complex</p> |
| <p>children</p> | <p>D1005_SenderOrgId D1006_RecipientOrgId D1007_TransactionTimestamp D1003_FlowReference</p> |
| <p>source</p> | <p><xs:element name="Header" type="TransactionHeaderType"/></p> |

complexType **AddressType**

| | |
|------------------|---------------------------------------------------------------------------------------------------------------------------------------------------------------------------------------------------------------------------------------------------------------------------------------------------------------------------------------------------------------------------------------------------------------------------------------------------------------------------------------------------------------------------------------------------------------------------------------------------------------------------------------------------------------------------------------------------------------------------------------------------------------------------------------------------------------------------------------------------------------------------------------------------------------------------------------------------------------|
| <p>diagram</p> | |
| <p>namespace</p> | <p>urn:bridgeall-com:cmaservice:data:v3</p> |
| <p>children</p> | <p>D5001_FreeDescriptor D5002_SubBuildingName D5003_BuildingName D5004_BuildingNumber D5005_DependentThoroughfareName D5006_DependentThoroughfareDescriptor D5007_ThoroughfareName D5008_ThoroughfareDescriptor D5009_DoubleDependentLocality D5010_DependentLocality D5011_PostTown D5012_County D5013_Postcode</p> |
| <p>used by</p> | <p>elements NewSPIDNotificationType/Address NewLPSPIDNotificationType/Address T012.0_MiscSPIDUpdateType/Address WaterSPIDDataTypes/Address SewerageSPIDDataTypes/Address DPIDNotificationType/Address DPIDUpdateType/Address T004.0_NewMeterType/MeterLocation T004.1_NewMeterNotificationType/MeterLocation MeterUpdateType/MeterLocation MeterUpdateNotificationType/MeterLocation NewSPIDRequestType/SPIDLocation</p> |
| <p>source</p> | <pre><xs:complexType name="AddressType"> <xs:sequence> <xs:element ref="D5001_FreeDescriptor" minOccurs="0"/> <xs:element name="D5002_SubBuildingName" minOccurs="0"> <xs:simpleType> <xs:restriction base="xs:string"> <xs:maxLength value="30"/> <xs:whiteSpace value="preserve"/> <xs:pattern value="([^\t\n\r])*"/> </xs:restriction> </xs:simpleType> </xs:element> <xs:element name="D5003_BuildingName" minOccurs="0"> <xs:simpleType> <xs:restriction base="xs:string"> <xs:maxLength value="50"/> <xs:whiteSpace value="preserve"/> <xs:pattern value="([^\t\n\r])*"/> </xs:restriction> </xs:simpleType> </xs:element> </xs:sequence> </xs:complexType></pre> |

```

</xs:restriction>
</xs:simpleType>
</xs:element>
<xs:element name="D5004_BuildingNumber" minOccurs="0">
  <xs:simpleType>
    <xs:restriction base="xs:string">
      <xs:maxLength value="4"/>
      <xs:pattern value="([^\t\n\r])*"/>
    </xs:restriction>
  </xs:simpleType>
</xs:element>
<xs:element name="D5005_DependentThoroughfareName" minOccurs="0">
  <xs:simpleType>
    <xs:restriction base="xs:string">
      <xs:maxLength value="60"/>
      <xs:pattern value="([^\t\n\r])*"/>
    </xs:restriction>
  </xs:simpleType>
</xs:element>
<xs:element name="D5006_DependentThoroughfareDescriptor"
minOccurs="0">
  <xs:simpleType>
    <xs:restriction base="xs:string">
      <xs:maxLength value="20"/>
      <xs:pattern value="([^\t\n\r])*"/>
    </xs:restriction>
  </xs:simpleType>
</xs:element>
<xs:element name="D5007_ThoroughfareName" minOccurs="0">
  <xs:simpleType>
    <xs:restriction base="xs:string">
      <xs:maxLength value="60"/>
      <xs:pattern value="([^\t\n\r])*"/>
    </xs:restriction>
  </xs:simpleType>
</xs:element>
<xs:element name="D5008_ThoroughfareDescriptor" minOccurs="0">
  <xs:simpleType>
    <xs:restriction base="xs:string">
      <xs:maxLength value="20"/>
      <xs:pattern value="([^\t\n\r])*"/>
    </xs:restriction>
  </xs:simpleType>
</xs:element>
<xs:element name="D5009_DoubleDependentLocality" minOccurs="0">
  <xs:simpleType>
    <xs:restriction base="xs:string">
      <xs:maxLength value="35"/>
      <xs:pattern value="([^\t\n\r])*"/>
    </xs:restriction>
  </xs:simpleType>
</xs:element>
<xs:element name="D5010_DependentLocality" minOccurs="0">
  <xs:simpleType>
    <xs:restriction base="xs:string">
      <xs:maxLength value="35"/>
      <xs:pattern value="([^\t\n\r])*"/>
    </xs:restriction>
  </xs:simpleType>

```

| | |
|--|---------------------------------------------------------------------------------------------------------------------------------------------------------------------------------------------------------------------------------------------------------------------------------------------------------------------------------------------------------------------------------------------------------------------------------------------------------------------------------------------------------------------------------------------------------------------------------------------------------------------------------------------------------------------------------------------------------------------------------------------|
| | <pre> </xs:element> <xs:element name="D5011_PostTown" minOccurs="0"> <xs:simpleType> <xs:restriction base="xs:string"> <xs:maxLength value="30"/> <xs:pattern value="([^\t\n\r])*"/> </xs:restriction> </xs:simpleType> </xs:element> <xs:element name="D5012_County" minOccurs="0"> <xs:simpleType> <xs:restriction base="xs:string"> <xs:maxLength value="30"/> <xs:pattern value="([^\t\n\r])*"/> </xs:restriction> </xs:simpleType> </xs:element> <xs:element name="D5013_Postcode" type="PostcodeType" minOccurs="0"/> </xs:sequence> </xs:complexType> </pre> |
|--|---------------------------------------------------------------------------------------------------------------------------------------------------------------------------------------------------------------------------------------------------------------------------------------------------------------------------------------------------------------------------------------------------------------------------------------------------------------------------------------------------------------------------------------------------------------------------------------------------------------------------------------------------------------------------------------------------------------------------------------------|

element AddressType/D5002_SubBuildingName

| diagram | | | | | | | | | | | | | |
|------------|-------------------------------------------------------------------------------------------------------------------------------------------------------------------------------------------------------------------------------------------------------------------------------------------------------------------------------------------------------------|------------|-------|------------|-----------|--------|---|------------|----------|--|---------|--------------|--|
| namespace | urn:bridgeall-com:cmaservice:data:v3 | | | | | | | | | | | | |
| type | restriction of xs:string | | | | | | | | | | | | |
| properties | <table> <tr><td>isRef</td><td>0</td></tr> <tr><td>minOcc</td><td>0</td></tr> <tr><td>maxOcc</td><td>1</td></tr> <tr><td>content</td><td>simple</td></tr> </table> | isRef | 0 | minOcc | 0 | maxOcc | 1 | content | simple | | | | |
| isRef | 0 | | | | | | | | | | | | |
| minOcc | 0 | | | | | | | | | | | | |
| maxOcc | 1 | | | | | | | | | | | | |
| content | simple | | | | | | | | | | | | |
| facets | <table> <thead> <tr> <th>Kind</th> <th>Value</th> <th>annotation</th> </tr> </thead> <tbody> <tr> <td>maxLength</td> <td>30</td> <td></td> </tr> <tr> <td>whiteSpace</td> <td>preserve</td> <td></td> </tr> <tr> <td>pattern</td> <td>([^\t\n\r]*)</td> <td></td> </tr> </tbody> </table> | Kind | Value | annotation | maxLength | 30 | | whiteSpace | preserve | | pattern | ([^\t\n\r]*) | |
| Kind | Value | annotation | | | | | | | | | | | |
| maxLength | 30 | | | | | | | | | | | | |
| whiteSpace | preserve | | | | | | | | | | | | |
| pattern | ([^\t\n\r]*) | | | | | | | | | | | | |
| source | <pre> <xs:element name="D5002_SubBuildingName" minOccurs="0"> <xs:simpleType> <xs:restriction base="xs:string"> <xs:maxLength value="30"/> <xs:whiteSpace value="preserve"/> <xs:pattern value="([^\t\n\r])*"/> </xs:restriction> </xs:simpleType> </xs:element> </pre> | | | | | | | | | | | | |

element AddressType/D5003_BuildingName

| | | | | | | | | | |
|------------|-------------------------------------------------------------------------------------------------------------------------------------------------------------------|-------|---|--------|---|--------|---|---------|--------|
| diagram | | | | | | | | | |
| namespace | urn:bridgeall-com:cmaservice:data:v3 | | | | | | | | |
| type | restriction of xs:string | | | | | | | | |
| properties | <table> <tr><td>isRef</td><td>0</td></tr> <tr><td>minOcc</td><td>0</td></tr> <tr><td>maxOcc</td><td>1</td></tr> <tr><td>content</td><td>simple</td></tr> </table> | isRef | 0 | minOcc | 0 | maxOcc | 1 | content | simple |
| isRef | 0 | | | | | | | | |
| minOcc | 0 | | | | | | | | |
| maxOcc | 1 | | | | | | | | |
| content | simple | | | | | | | | |

| | | | |
|--------|--------------------------------------------------------------------------------------------------------------------------------------------------------------------------------------------------------------------------------------------------------------------------------------------------------------------------------------------------------|-----------------------------------------|------------|
| facets | Kind maxLength whiteSpace pattern | Value 50 preserve ([^\t\n\r]*) | annotation |
| source | <pre><xs:element name="D5003_BuildingName" minOccurs="0"> <xs:simpleType> <xs:restriction base="xs:string"> <xs:maxLength value="50"/> <xs:whiteSpace value="preserve"/> <xs:pattern value="([^\t\n\r]*)"/> </xs:restriction> </xs:simpleType> </xs:element></pre> | | |

element AddressType/D5004_BuildingNumber

| | | | |
|------------|-----------------------------------------------------------------------------------------------------------------------------------------------------------------------------------------------------------------------------------------------------------------------------------------------------------|----------------------------|------------|
| diagram |  | | |
| namespace | urn:bridgeall-com:cmaservice:data:v3 | | |
| type | restriction of xs:string | | |
| properties | isRef minOcc maxOcc content | 0 0 1 simple | |
| facets | Kind maxLength pattern | Value 4 ([^\t\n\r]*) | annotation |
| source | <pre><xs:element name="D5004_BuildingNumber" minOccurs="0"> <xs:simpleType> <xs:restriction base="xs:string"> <xs:maxLength value="4"/> <xs:pattern value="([^\t\n\r]*)"/> </xs:restriction> </xs:simpleType> </xs:element></pre> | | |

element AddressType/D5005_DependentThoroughfareName

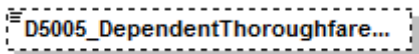
| | | | |
|------------|------------------------------------------------------------------------------------------------------------------------------------------------------------------------------------------------------------------------------------------------------------------------|-----------------------------|------------|
| diagram |  | | |
| namespace | urn:bridgeall-com:cmaservice:data:v3 | | |
| type | restriction of xs:string | | |
| properties | isRef minOcc maxOcc content | 0 0 1 simple | |
| facets | Kind maxLength pattern | Value 60 ([^\t\n\r]*) | annotation |
| source | <pre><xs:element name="D5005_DependentThoroughfareName" minOccurs="0"> <xs:simpleType> <xs:restriction base="xs:string"> <xs:maxLength value="60"/> </xs:restriction> </xs:simpleType> </xs:element></pre> | | |

| | |
|--|--------------------------------------------------------------------------------------------------------------------------|
| | <pre> <xs:pattern value="([^\t\n\r])*"/> </xs:restriction> </xs:simpleType> </xs:element> </pre> |
|--|--------------------------------------------------------------------------------------------------------------------------|

element **AddressType/D5006_DependentThoroughfareDescriptor**

| | | | | | | | | | | |
|------------|-------------------------------------------------------------------------------------------------------------------------------------------------------------------------------------------------------------------------------------------------------------------------------------------------------------------------------|------------|-------|------------|-----------|--------|---|---------|--------------|--|
| diagram | | | | | | | | | | |
| namespace | urn:bridgeall-com:cmaservice:data:v3 | | | | | | | | | |
| type | restriction of xs:string | | | | | | | | | |
| properties | <table border="0"> <tr><td>isRef</td><td>0</td></tr> <tr><td>minOcc</td><td>0</td></tr> <tr><td>maxOcc</td><td>1</td></tr> <tr><td>content</td><td>simple</td></tr> </table> | isRef | 0 | minOcc | 0 | maxOcc | 1 | content | simple | |
| isRef | 0 | | | | | | | | | |
| minOcc | 0 | | | | | | | | | |
| maxOcc | 1 | | | | | | | | | |
| content | simple | | | | | | | | | |
| facets | <table border="0"> <tr><td>Kind</td><td>Value</td><td>annotation</td></tr> <tr><td>maxLength</td><td>20</td><td></td></tr> <tr><td>pattern</td><td colspan="2">([^\t\n\r])*</td></tr> </table> | Kind | Value | annotation | maxLength | 20 | | pattern | ([^\t\n\r])* | |
| Kind | Value | annotation | | | | | | | | |
| maxLength | 20 | | | | | | | | | |
| pattern | ([^\t\n\r])* | | | | | | | | | |
| source | <pre> <xs:element name="D5006_DependentThoroughfareDescriptor" minOccurs="0"> <xs:simpleType> <xs:restriction base="xs:string"> <xs:maxLength value="20"/> <xs:pattern value="([^\t\n\r])*"/> </xs:restriction> </xs:simpleType> </xs:element> </pre> | | | | | | | | | |

element **AddressType/D5007_ThoroughfareName**

| | | | | | | | | | | |
|------------|----------------------------------------------------------------------------------------------------------------------------------------------------------------------------------------------------------------------------------------------------------------------------------------------------------------|------------|-------|------------|-----------|--------|---|---------|--------------|--|
| diagram | | | | | | | | | | |
| namespace | urn:bridgeall-com:cmaservice:data:v3 | | | | | | | | | |
| type | restriction of xs:string | | | | | | | | | |
| properties | <table border="0"> <tr><td>isRef</td><td>0</td></tr> <tr><td>minOcc</td><td>0</td></tr> <tr><td>maxOcc</td><td>1</td></tr> <tr><td>content</td><td>simple</td></tr> </table> | isRef | 0 | minOcc | 0 | maxOcc | 1 | content | simple | |
| isRef | 0 | | | | | | | | | |
| minOcc | 0 | | | | | | | | | |
| maxOcc | 1 | | | | | | | | | |
| content | simple | | | | | | | | | |
| facets | <table border="0"> <tr><td>Kind</td><td>Value</td><td>annotation</td></tr> <tr><td>maxLength</td><td>60</td><td></td></tr> <tr><td>pattern</td><td colspan="2">([^\t\n\r])*</td></tr> </table> | Kind | Value | annotation | maxLength | 60 | | pattern | ([^\t\n\r])* | |
| Kind | Value | annotation | | | | | | | | |
| maxLength | 60 | | | | | | | | | |
| pattern | ([^\t\n\r])* | | | | | | | | | |
| source | <pre> <xs:element name="D5007_ThoroughfareName" minOccurs="0"> <xs:simpleType> <xs:restriction base="xs:string"> <xs:maxLength value="60"/> <xs:pattern value="([^\t\n\r])*"/> </xs:restriction> </xs:simpleType> </xs:element> </pre> | | | | | | | | | |

element **AddressType/D5008_ThoroughfareDescriptor**

| | | | | | | | | | | |
|------------|--------------------------------------------------------------------------------------------------------------------------------------------------------------------------------------------------------------------------------------------------------------------------------------------------------------------|------------|-------|------------|-----------|--------|---|---------|--------------|--|
| diagram | | | | | | | | | | |
| namespace | urn:bridgeall-com:cmaservice:data:v3 | | | | | | | | | |
| type | restriction of xs:string | | | | | | | | | |
| properties | <table> <tr><td>isRef</td><td>0</td></tr> <tr><td>minOcc</td><td>0</td></tr> <tr><td>maxOcc</td><td>1</td></tr> <tr><td>content</td><td>simple</td></tr> </table> | isRef | 0 | minOcc | 0 | maxOcc | 1 | content | simple | |
| isRef | 0 | | | | | | | | | |
| minOcc | 0 | | | | | | | | | |
| maxOcc | 1 | | | | | | | | | |
| content | simple | | | | | | | | | |
| facets | <table> <tr><td>Kind</td><td>Value</td><td>annotation</td></tr> <tr><td>maxLength</td><td>20</td><td></td></tr> <tr><td>pattern</td><td colspan="2">([^\t\n\r])*</td></tr> </table> | Kind | Value | annotation | maxLength | 20 | | pattern | ([^\t\n\r])* | |
| Kind | Value | annotation | | | | | | | | |
| maxLength | 20 | | | | | | | | | |
| pattern | ([^\t\n\r])* | | | | | | | | | |
| source | <pre><xs:element name="D5008_ThoroughfareDescriptor" minOccurs="0"> <xs:simpleType> <xs:restriction base="xs:string"> <xs:maxLength value="20"/> <xs:pattern value="([^\t\n\r])*"/> </xs:restriction> </xs:simpleType> </xs:element></pre> | | | | | | | | | |

element **AddressType/D5009_DoubleDependentLocality**

| | | | | | | | | | | |
|------------|---------------------------------------------------------------------------------------------------------------------------------------------------------------------------------------------------------------------------------------------------------------------------------------------------------------------|------------|-------|------------|-----------|--------|---|---------|--------------|--|
| diagram | | | | | | | | | | |
| namespace | urn:bridgeall-com:cmaservice:data:v3 | | | | | | | | | |
| type | restriction of xs:string | | | | | | | | | |
| properties | <table> <tr><td>isRef</td><td>0</td></tr> <tr><td>minOcc</td><td>0</td></tr> <tr><td>maxOcc</td><td>1</td></tr> <tr><td>content</td><td>simple</td></tr> </table> | isRef | 0 | minOcc | 0 | maxOcc | 1 | content | simple | |
| isRef | 0 | | | | | | | | | |
| minOcc | 0 | | | | | | | | | |
| maxOcc | 1 | | | | | | | | | |
| content | simple | | | | | | | | | |
| facets | <table> <tr><td>Kind</td><td>Value</td><td>annotation</td></tr> <tr><td>maxLength</td><td>35</td><td></td></tr> <tr><td>pattern</td><td colspan="2">([^\t\n\r])*</td></tr> </table> | Kind | Value | annotation | maxLength | 35 | | pattern | ([^\t\n\r])* | |
| Kind | Value | annotation | | | | | | | | |
| maxLength | 35 | | | | | | | | | |
| pattern | ([^\t\n\r])* | | | | | | | | | |
| source | <pre><xs:element name="D5009_DoubleDependentLocality" minOccurs="0"> <xs:simpleType> <xs:restriction base="xs:string"> <xs:maxLength value="35"/> <xs:pattern value="([^\t\n\r])*"/> </xs:restriction> </xs:simpleType> </xs:element></pre> | | | | | | | | | |

element **AddressType/D5010_DependentLocality**

| | | | | | | | | | |
|------------|-------------------------------------------------------------------------------------------------------------------------------------------------------------------|-------|---|--------|---|--------|---|---------|--------|
| diagram | | | | | | | | | |
| namespace | urn:bridgeall-com:cmaservice:data:v3 | | | | | | | | |
| type | restriction of xs:string | | | | | | | | |
| properties | <table> <tr><td>isRef</td><td>0</td></tr> <tr><td>minOcc</td><td>0</td></tr> <tr><td>maxOcc</td><td>1</td></tr> <tr><td>content</td><td>simple</td></tr> </table> | isRef | 0 | minOcc | 0 | maxOcc | 1 | content | simple |
| isRef | 0 | | | | | | | | |
| minOcc | 0 | | | | | | | | |
| maxOcc | 1 | | | | | | | | |
| content | simple | | | | | | | | |

| | | | |
|--------|---------------------------------------------------------------------------------------------------------------------------------------------------------------------------------------------------------------------------------------------------------------------------------------------------------------|-----------------------------|------------|
| facets | Kind maxLength pattern | Value 35 ([^\t\n\r])* | annotation |
| source | <pre><xs:element name="D5010_DependentLocality" minOccurs="0"> <xs:simpleType> <xs:restriction base="xs:string"> <xs:maxLength value="35"/> <xs:pattern value="([^\t\n\r])*"/> </xs:restriction> </xs:simpleType> </xs:element></pre> | | |

element AddressType/D5011_PostTown

| | | | |
|------------|------------------------------------------------------------------------------------------------------------------------------------------------------------------------------------------------------------------------------------------------------------------------------------------------------|-----------------------------|------------|
| diagram |  | | |
| namespace | urn:bridgeall-com:cmaservice:data:v3 | | |
| type | restriction of xs:string | | |
| properties | isRef | 0 | |
| | minOcc | 0 | |
| | maxOcc | 1 | |
| | content | simple | |
| facets | Kind maxLength pattern | Value 30 ([^\t\n\r])* | annotation |
| source | <pre><xs:element name="D5011_PostTown" minOccurs="0"> <xs:simpleType> <xs:restriction base="xs:string"> <xs:maxLength value="30"/> <xs:pattern value="([^\t\n\r])*"/> </xs:restriction> </xs:simpleType> </xs:element></pre> | | |

element AddressType/D5012_County

| | | | |
|------------|----------------------------------------------------------------------------------------------------------------------------------------------------------------------------------------------------------------------------------------------------------------------------------------------------|-----------------------------|------------|
| diagram |  | | |
| namespace | urn:bridgeall-com:cmaservice:data:v3 | | |
| type | restriction of xs:string | | |
| properties | isRef | 0 | |
| | minOcc | 0 | |
| | maxOcc | 1 | |
| | content | simple | |
| facets | Kind maxLength pattern | Value 30 ([^\t\n\r])* | annotation |
| source | <pre><xs:element name="D5012_County" minOccurs="0"> <xs:simpleType> <xs:restriction base="xs:string"> <xs:maxLength value="30"/> <xs:pattern value="([^\t\n\r])*"/> </xs:restriction> </xs:simpleType> </xs:element></pre> | | |

| | |
|--|----------------------------------|
| | <code></xs:element></code> |
|--|----------------------------------|

element AddressType/D5013_Postcode

| | | | | | | | | | |
|------------|--------------------------------------------------------------------------------------------------------------------------------------------------------------------|-------|---|--------|---|--------|---|---------|---------|
| diagram | | | | | | | | | |
| namespace | urn:bridgeall-com:cmaservice:data:v3 | | | | | | | | |
| type | PostcodeType | | | | | | | | |
| properties | <table> <tr><td>isRef</td><td>0</td></tr> <tr><td>minOcc</td><td>0</td></tr> <tr><td>maxOcc</td><td>1</td></tr> <tr><td>content</td><td>complex</td></tr> </table> | isRef | 0 | minOcc | 0 | maxOcc | 1 | content | complex |
| isRef | 0 | | | | | | | | |
| minOcc | 0 | | | | | | | | |
| maxOcc | 1 | | | | | | | | |
| content | complex | | | | | | | | |
| children | Outcode Incode | | | | | | | | |
| source | <code><xs:element name="D5013_Postcode" type="PostcodeType" minOccurs="0"/></code> | | | | | | | | |

complexType CancelRegistrationNotificationOutType

| diagram | | | | | | | | | | | | | | | | | | | |
|----------------------------|---------------------------------------------------------------------------------------------------------------------------------------------------------------------------------------------------------------------------------------------------------------------------------------------------------------------------------------------------------------------------------------------------------------------------------|----------|---------|-------|------------|-------|------------|---------------------|-------------------------------|----------|--|--|--|----------------------------|-------------------------------|----------|--|--|--|
| namespace | urn:bridgeall-com:cmaservice:data:v3 | | | | | | | | | | | | | | | | | | |
| type | extension of MessageBody | | | | | | | | | | | | | | | | | | |
| properties | base MessageBody | | | | | | | | | | | | | | | | | | |
| children | D2001_SPID | | | | | | | | | | | | | | | | | | |
| used by | element ResponseMessagesType/T011.1 CancelRegistrationNotificationOutgoing | | | | | | | | | | | | | | | | | | |
| attributes | <table> <thead> <tr> <th>Name</th> <th>Type</th> <th>Use</th> <th>Default</th> <th>Fixed</th> <th>annotation</th> </tr> </thead> <tbody> <tr> <td>MID</td> <td>MessageIdType</td> <td>required</td> <td></td> <td></td> <td></td> </tr> <tr> <td>RelatedMID</td> <td>MessageIdType</td> <td>optional</td> <td></td> <td></td> <td></td> </tr> </tbody> </table> | Name | Type | Use | Default | Fixed | annotation | MID | MessageIdType | required | | | | RelatedMID | MessageIdType | optional | | | |
| Name | Type | Use | Default | Fixed | annotation | | | | | | | | | | | | | | |
| MID | MessageIdType | required | | | | | | | | | | | | | | | | | |
| RelatedMID | MessageIdType | optional | | | | | | | | | | | | | | | | | |
| source | <pre> <xs:complexType name="CancelRegistrationNotificationOutType"> <xs:complexContent> <xs:extension base="MessageBody"> <xs:sequence> <xs:element ref="D2001_SPID"/> </xs:sequence> </xs:extension> </xs:complexContent> </pre> | | | | | | | | | | | | | | | | | | |

</xs:complexType>

complexType CancelRegistrationNotificationType

| diagram | | | | | | | | | | | | | | | | | | | |
|----------------------------|---------------------------------------------------------------------------------------------------------------------------------------------------------------------------------------------------------------------------------------------------------------------------------------------------------------------------------------------------------------------------------------------------------------------------------------------------------------------------|----------|---------|-------|------------|-------|------------|---------------------|-------------------------------|----------|--|--|--|----------------------------|-------------------------------|----------|--|--|--|
| namespace | urn:bridgeall-com:cmaservice:data:v3 | | | | | | | | | | | | | | | | | | |
| type | extension of MessageBody | | | | | | | | | | | | | | | | | | |
| properties | base MessageBody | | | | | | | | | | | | | | | | | | |
| children | D2001_SPID D4003_Comment D4005_CancellationCode | | | | | | | | | | | | | | | | | | |
| used by | element ResponseMessagesType/T011.0 CancelRegistrationNotificationIncoming | | | | | | | | | | | | | | | | | | |
| attributes | <table border="1"><thead><tr><th>Name</th><th>Type</th><th>Use</th><th>Default</th><th>Fixed</th><th>annotation</th></tr></thead><tbody><tr><td>MID</td><td>MessageIdType</td><td>required</td><td></td><td></td><td></td></tr><tr><td>RelatedMID</td><td>MessageIdType</td><td>optional</td><td></td><td></td><td></td></tr></tbody></table> | Name | Type | Use | Default | Fixed | annotation | MID | MessageIdType | required | | | | RelatedMID | MessageIdType | optional | | | |
| Name | Type | Use | Default | Fixed | annotation | | | | | | | | | | | | | | |
| MID | MessageIdType | required | | | | | | | | | | | | | | | | | |
| RelatedMID | MessageIdType | optional | | | | | | | | | | | | | | | | | |
| source | <pre><xs:complexType name="CancelRegistrationNotificationType"> <xs:complexContent> <xs:extension base="MessageBody"> <xs:sequence> <xs:element ref="D2001_SPID"/> <xs:element ref="D4003_Comment" minOccurs="0"/> <xs:element ref="D4005_CancellationCode" minOccurs="0"/> </xs:sequence> </xs:extension> </xs:complexContent> </xs:complexType></pre> | | | | | | | | | | | | | | | | | | |

complexType **CancelRegistrationOutType**

| <p>diagram</p> | | | | | | | | | | | | | | | | | | | |
|----------------------------|--------------------------------------------------------------------------------------------------------------------------------------------------------------------------------------------------------------------------------------------------------------------------------------------------------------------------------------------------------------------------------------------------------------------------------------------|----------|---------|-------|------------|-------|------------|---------------------|-------------------------------|----------|--|--|--|----------------------------|-------------------------------|----------|--|--|--|
| <p>namespace</p> | <p>urn:bridgeall-com:cmaservice:data:v3</p> | | | | | | | | | | | | | | | | | | |
| <p>type</p> | <p>extension of CancelRegistrationType</p> | | | | | | | | | | | | | | | | | | |
| <p>properties</p> | <p>base CancelRegistrationType</p> | | | | | | | | | | | | | | | | | | |
| <p>children</p> | <p>D2001_SPID D4005_CancellationCode D4003_Comment</p> | | | | | | | | | | | | | | | | | | |
| <p>used by</p> | <p>element MessagesType/T010.1 CancelRegistrationOutgoings/T010.1 CancelRegistrationOutgoing</p> | | | | | | | | | | | | | | | | | | |
| <p>attributes</p> | <table border="1"> <thead> <tr> <th>Name</th> <th>Type</th> <th>Use</th> <th>Default</th> <th>Fixed</th> <th>annotation</th> </tr> </thead> <tbody> <tr> <td>MID</td> <td>MessageIdType</td> <td>required</td> <td></td> <td></td> <td></td> </tr> <tr> <td>RelatedMID</td> <td>MessageIdType</td> <td>optional</td> <td></td> <td></td> <td></td> </tr> </tbody> </table> | Name | Type | Use | Default | Fixed | annotation | MID | MessageIdType | required | | | | RelatedMID | MessageIdType | optional | | | |
| Name | Type | Use | Default | Fixed | annotation | | | | | | | | | | | | | | |
| MID | MessageIdType | required | | | | | | | | | | | | | | | | | |
| RelatedMID | MessageIdType | optional | | | | | | | | | | | | | | | | | |
| <p>source</p> | <pre><xs:complexType name="CancelRegistrationOutType"> <xs:complexContent> <xs:extension base="CancelRegistrationType"> <xs:sequence> <xs:element ref="D4003_Comment"/> </xs:sequence> </xs:extension> </xs:complexContent> </xs:complexType></pre> | | | | | | | | | | | | | | | | | | |

complexType **CancelRegistrationType**

| | | | | | | |
|------------|-------------------------------------------------------------------------------------------------------------------------------------------------------------------------------------------------------------------------------------------------------------------------------------------------------------------------------------------------------------------------------------|---------------------------------------------------------------------------------------------------|----------|---------|-------|------------|
| diagram | | | | | | |
| namespace | urn:bridgeall-com:cmaservice:data:v3 | | | | | |
| type | extension of MessageBody | | | | | |
| properties | base MessageBody | | | | | |
| children | D2001_SPID D4005_CancellationCode | | | | | |
| used by | element | MessagesType/T010.0 CancelRegistrationIncomings/T010.0 CancelRegistrationIncoming | | | | |
| | complexType | CancelRegistrationOutType | | | | |
| attributes | Name | Type | Use | Default | Fixed | annotation |
| | MID | MessageIdType | required | | | |
| | RelatedMID | MessageIdType | optional | | | |
| source | <pre> <xs:complexType name="CancelRegistrationType"> <xs:complexContent> <xs:extension base="MessageBody"> <xs:sequence> <xs:element ref="D2001_SPID"/> <xs:element ref="D4005_CancellationCode"/> </xs:sequence> </xs:extension> </xs:complexContent> </xs:complexType> </pre> | | | | | |

complexType **ChargeableMeterUpdateType**

| <p>diagram</p> | | | | | | | | | | | | | | | | | | | |
|----------------------------|--------------------------------------------------------------------------------------------------------------------------------------------------------------------------------------------------------------------------------------------------------------------------------------------------------------------------------------------------------------------------------------------------------------------------------------------|----------|---------|-------|------------|-------|------------|---------------------|-------------------------------|----------|--|--|--|----------------------------|-------------------------------|----------|--|--|--|
| <p>namespace</p> | <p>urn:bridgeall-com:cmaservice:data:v3</p> | | | | | | | | | | | | | | | | | | |
| <p>type</p> | <p>extension of MessageBody</p> | | | | | | | | | | | | | | | | | | |
| <p>properties</p> | <p>base MessageBody</p> | | | | | | | | | | | | | | | | | | |
| <p>children</p> | <p>D2001_SPID D3001_MeterId D3002_ChargeableMeterSize D3005_SewerageChargeableMeterSize D4003_Comment D3007_ReturnToSewerAllowance D4006_EffectiveFrom</p> | | | | | | | | | | | | | | | | | | |
| <p>used by</p> | <p>elements MessagesType/T014.0_ChargeableMeterUpdates/T014.0_ChargeableMeterUpdateResponseMessagesType/T014.1_MeterUpdateNotification</p> | | | | | | | | | | | | | | | | | | |
| <p>attributes</p> | <table border="1"> <thead> <tr> <th>Name</th> <th>Type</th> <th>Use</th> <th>Default</th> <th>Fixed</th> <th>annotation</th> </tr> </thead> <tbody> <tr> <td>MID</td> <td>MessageIdType</td> <td>required</td> <td></td> <td></td> <td></td> </tr> <tr> <td>RelatedMID</td> <td>MessageIdType</td> <td>optional</td> <td></td> <td></td> <td></td> </tr> </tbody> </table> | Name | Type | Use | Default | Fixed | annotation | MID | MessageIdType | required | | | | RelatedMID | MessageIdType | optional | | | |
| Name | Type | Use | Default | Fixed | annotation | | | | | | | | | | | | | | |
| MID | MessageIdType | required | | | | | | | | | | | | | | | | | |
| RelatedMID | MessageIdType | optional | | | | | | | | | | | | | | | | | |
| <p>annotation</p> | <p>documentation</p> | | | | | | | | | | | | | | | | | | |
| <p>source</p> | <pre><xs:complexType name="ChargeableMeterUpdateType"> <xs:annotation> <xs:documentation> </xs:documentation> </xs:documentation> </xs:complexType></pre> | | | | | | | | | | | | | | | | | | |

```

</xs:annotation>
<xs:complexContent>
  <xs:extension base="MessageBody">
    <xs:sequence>
      <xs:element ref="D2001_SPID"/>
      <xs:element ref="D3001_MeterId"/>
      <xs:element ref="D3002_ChargeableMeterSize" minOccurs="0"/>
      <xs:element ref="D3005_SewerageChargeableMeterSize" minOccurs="0"/>
      <xs:element ref="D4003_Comment"/>
      <xs:element ref="D3007_ReturnToSewerAllowance" minOccurs="0"/>
      <xs:element ref="D4006_EffectiveFrom"/>
    </xs:sequence>
  </xs:extension>
</xs:complexContent>
</xs:complexType>

```

complexType ConnectionCompleteType

| diagram | | | | | | | | | | | | | | | | | | | |
|----------------------------|--------------------------------------------------------------------------------------------------------------------------------------------------------------------------------------------------------------------------------------------------------------------------------------------------------------------------------------------------------------------------------------------------------------------------------------------|----------|---------|-------|------------|-------|------------|---------------------|-------------------------------|----------|--|--|--|----------------------------|-------------------------------|----------|--|--|--|
| namespace | urn:bridgeall-com:cmaservice:data:v3 | | | | | | | | | | | | | | | | | | |
| type | extension of MessageBody | | | | | | | | | | | | | | | | | | |
| properties | base MessageBody | | | | | | | | | | | | | | | | | | |
| children | D2001_SPID D2013_ConnectionDate | | | | | | | | | | | | | | | | | | |
| used by | elements MessagesType/T007.1 SewerageConnectionCompletes/T007.1 SewerageConnectionComplete ResponseMessagesType/T007.2 ConnectionCompleteNotification | | | | | | | | | | | | | | | | | | |
| attributes | <table border="1"> <thead> <tr> <th>Name</th> <th>Type</th> <th>Use</th> <th>Default</th> <th>Fixed</th> <th>annotation</th> </tr> </thead> <tbody> <tr> <td>MID</td> <td>MessageIdType</td> <td>required</td> <td></td> <td></td> <td></td> </tr> <tr> <td>RelatedMID</td> <td>MessageIdType</td> <td>optional</td> <td></td> <td></td> <td></td> </tr> </tbody> </table> | Name | Type | Use | Default | Fixed | annotation | MID | MessageIdType | required | | | | RelatedMID | MessageIdType | optional | | | |
| Name | Type | Use | Default | Fixed | annotation | | | | | | | | | | | | | | |
| MID | MessageIdType | required | | | | | | | | | | | | | | | | | |
| RelatedMID | MessageIdType | optional | | | | | | | | | | | | | | | | | |
| annotation | documentation | | | | | | | | | | | | | | | | | | |
| source | <pre> <xs:complexType name="ConnectionCompleteType"> <xs:annotation> <xs:documentation> </xs:documentation> </xs:annotation> <xs:complexContent> <xs:extension base="MessageBody"> </pre> | | | | | | | | | | | | | | | | | | |

```

<xs:sequence>
  <xs:element ref="D2001_SPID"/>
  <xs:element ref="D2013_ConnectionDate"/>
</xs:sequence>
</xs:extension>
</xs:complexContent>
</xs:complexType>

```

complexType CustomerNameUpdatedNotificationType

| | | | | | | |
|------------|----------------------------------------------------------------------------------------------------------------------------------------------------------------------------------------------------------------------------|-------------------------------|----------|---------|-------|------------|
| diagram | | | | | | |
| namespace | urn:bridgeall-com:cmaservice:data:v3 | | | | | |
| type | extension of MessageBody | | | | | |
| properties | base MessageBody | | | | | |
| children | D2001_SPID D2027_CustomerName D2028_CustomerNameType D4001_OrgId | | | | | |
| used by | element ResponseMessagesType/T032.2_CustomerNameUpdatedNotification | | | | | |
| attributes | Name | Type | Use | Default | Fixed | annotation |
| | MID | MessageIdType | required | | | |
| | RelatedMID | MessageIdType | optional | | | |
| annotation | documentation | | | | | |
| source | <pre> <xs:complexType name="CustomerNameUpdatedNotificationType"> <xs:annotation> <xs:documentation> </xs:documentation> </xs:annotation> <xs:complexContent> </pre> | | | | | |

```

<xs:extension base="MessageBody">
  <xs:sequence>
    <xs:element ref="D2001_SPID"/>
    <xs:element ref="D2027_CustomerName"/>
    <xs:element ref="D2028_CustomerNameType"/>
    <xs:element ref="D4001_OrgId"/>
  </xs:sequence>
</xs:extension>
</xs:complexContent>
</xs:complexType>

```

complexType **DisconnectionType**

| diagram | | | | | | | | | | | | | | | | | | | |
|----------------------------|--------------------------------------------------------------------------------------------------------------------------------------------------------------------------------------------------------------------------------------------------------------------------------------------------------------------------------------------------------------------------------------------------------------------------------------------|----------|---------|-------|------------|-------|------------|---------------------|-------------------------------|----------|--|--|--|----------------------------|-------------------------------|----------|--|--|--|
| namespace | urn:bridgeall-com:cmaservice:data:v3 | | | | | | | | | | | | | | | | | | |
| type | extension of MessageBody | | | | | | | | | | | | | | | | | | |
| properties | base MessageBody | | | | | | | | | | | | | | | | | | |
| children | D2001_SPID D4006_EffectiveFrom D2025_DisconnectionReconnection | | | | | | | | | | | | | | | | | | |
| used by | elements MessagesType/T015.0_DisconnectionDeclarations/T015.0_DisconnectionDeclarationResponseMessagesType/T015.1_DisconnectionNotification | | | | | | | | | | | | | | | | | | |
| attributes | <table border="1"> <thead> <tr> <th>Name</th> <th>Type</th> <th>Use</th> <th>Default</th> <th>Fixed</th> <th>annotation</th> </tr> </thead> <tbody> <tr> <td>MID</td> <td>MessageIdType</td> <td>required</td> <td></td> <td></td> <td></td> </tr> <tr> <td>RelatedMID</td> <td>MessageIdType</td> <td>optional</td> <td></td> <td></td> <td></td> </tr> </tbody> </table> | Name | Type | Use | Default | Fixed | annotation | MID | MessageIdType | required | | | | RelatedMID | MessageIdType | optional | | | |
| Name | Type | Use | Default | Fixed | annotation | | | | | | | | | | | | | | |
| MID | MessageIdType | required | | | | | | | | | | | | | | | | | |
| RelatedMID | MessageIdType | optional | | | | | | | | | | | | | | | | | |
| annotation | documentation | | | | | | | | | | | | | | | | | | |
| source | <pre> <xs:complexType name="DisconnectionType"> <xs:annotation> <xs:documentation> </xs:documentation> </xs:annotation> <xs:complexContent> <xs:extension base="MessageBody"> <xs:sequence> <xs:element ref="D2001_SPID"/> <xs:element ref="D4006_EffectiveFrom"/> </pre> | | | | | | | | | | | | | | | | | | |

```

<xs:element ref="D2025_DisconnectionReconnection"/>
</xs:sequence>
</xs:extension>
</xs:complexContent>
</xs:complexType>

```

complexType **DiscontinueDPIDType**

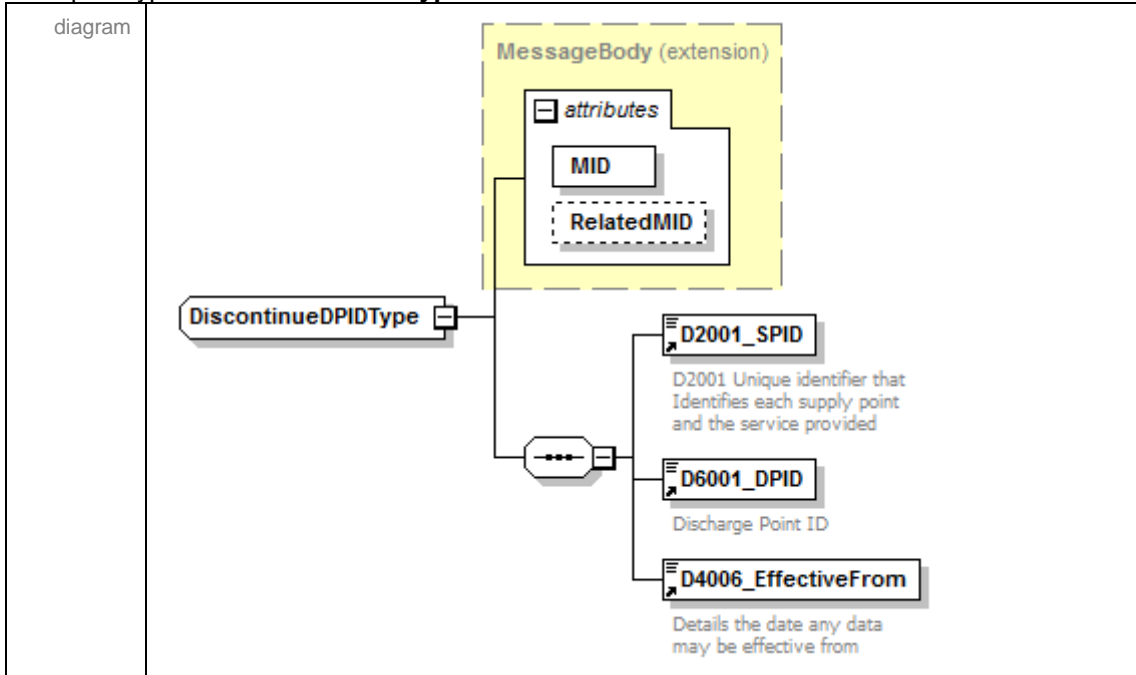

| namespace | urn:bridgeall-com:cmaservice:data:v3 | | | | | | | | | | | | | | | | | | |
|----------------------------|--------------------------------------------------------------------------------------------------------------------------------------------------------------------------------------------------------------------------------------------------------------------------------------------------------------------------------------------------------------------------------------------------------------------------------------------|----------|---------|-------|------------|-------|------------|---------------------|-------------------------------|----------|--|--|--|----------------------------|-------------------------------|----------|--|--|--|
| type | extension of MessageBody | | | | | | | | | | | | | | | | | | |
| properties | base MessageBody | | | | | | | | | | | | | | | | | | |
| children | D2001_SPID D6001_DPID D4006_EffectiveFrom | | | | | | | | | | | | | | | | | | |
| used by | elements MessagesType/T026.0_DiscontinueDPIDs/T026.0_DiscontinueDPIDResponseMessagesType/T026.1_DiscontinueDPIDNotification | | | | | | | | | | | | | | | | | | |
| attributes | <table border="1"> <thead> <tr> <th>Name</th> <th>Type</th> <th>Use</th> <th>Default</th> <th>Fixed</th> <th>annotation</th> </tr> </thead> <tbody> <tr> <td>MID</td> <td>MessageIdType</td> <td>required</td> <td></td> <td></td> <td></td> </tr> <tr> <td>RelatedMID</td> <td>MessageIdType</td> <td>optional</td> <td></td> <td></td> <td></td> </tr> </tbody> </table> | Name | Type | Use | Default | Fixed | annotation | MID | MessageIdType | required | | | | RelatedMID | MessageIdType | optional | | | |
| Name | Type | Use | Default | Fixed | annotation | | | | | | | | | | | | | | |
| MID | MessageIdType | required | | | | | | | | | | | | | | | | | |
| RelatedMID | MessageIdType | optional | | | | | | | | | | | | | | | | | |
| annotation | documentation | | | | | | | | | | | | | | | | | | |

```

<xs:complexType name="DiscontinueDPIDType">
  <xs:annotation>
    <xs:documentation>
      </xs:documentation>
    </xs:annotation>
    <xs:complexContent>
      <xs:extension base="MessageBody">
        <xs:sequence>
          <xs:element ref="D2001_SPID"/>
          <xs:element ref="D6001_DPID"/>
          <xs:element ref="D4006_EffectiveFrom"/>
        </xs:sequence>
      </xs:extension>
    </xs:complexContent>
  </xs:complexType>

```

| |
|-------------------|
| </xs:complexType> |
|-------------------|

complexType **DPIDNotificationType**

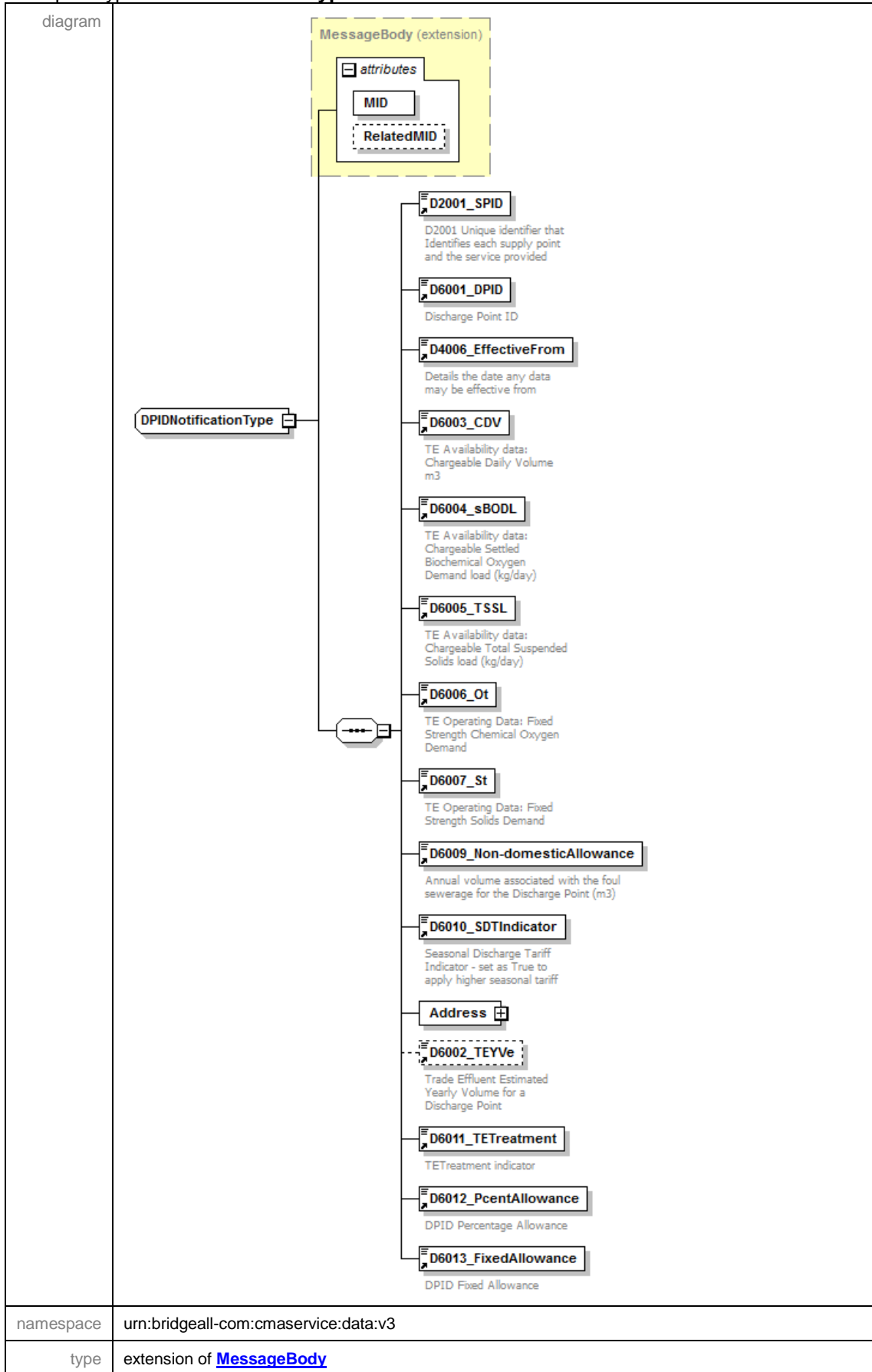

| | | | | | | |
|------------|-------------------------------------------------------------------------------------------------------------------------------------------------------------------------------------------------------------------------------------------------------------------------------------------------------------------------------------------------------------------------------------------------------------------------------------------------------------------------------------------------------------------------------------------------------------------------------------------------------------------------------------------------------------------------------------------------------------------------------------------------------------------------------------------------------------------------------------------------------------------------------------------------------------------------------------------------------------------------------------------------------------------------------------------------------------------------------------------------------------------------------------------------------------------------------------------------------------------------------------|-----------------------------------------------------------------------------------------------------------------------------|----------|---------|-------|------------|
| properties | base MessageBody | | | | | |
| children | D2001_SPID D6001_DPID D4006_EffectiveFrom D6003_CDV D6004_sBODL D6005_TSSL D6006_Ot D6007_St D6009_Non-domesticAllowance D6010_SDTIndicator Address D6002_TeYVe D6011_TETreatment D6012_PcentAllowance D6013_FixedAllowance | | | | | |
| used by | elements | MessagesType/T021.0_NewDPIDs/T021.0_NewDPID ResponseMessagesType/T021.1_DPIDNotification | | | | |
| attributes | Name | Type | Use | Default | Fixed | annotation |
| | MID | MessageIdType | required | | | |
| | RelatedMID | MessageIdType | optional | | | |
| annotation | documentation | | | | | |
| source | <pre> <xs:complexType name="DPIDNotificationType"> <xs:annotation> <xs:documentation> </xs:documentation> </xs:annotation> <xs:complexContent> <xs:extension base="MessageBody"> <xs:sequence> <xs:element ref="D2001_SPID"/> <xs:element ref="D6001_DPID"/> <xs:element ref="D4006_EffectiveFrom"/> <xs:element ref="D6003_CDV"/> <xs:element ref="D6004_sBODL"/> <xs:element ref="D6005_TSSL"/> <xs:element ref="D6006_Ot"/> <xs:element ref="D6007_St"/> <xs:element ref="D6009_Non-domesticAllowance"/> <xs:element ref="D6010_SDTIndicator"/> <xs:element name="Address" type="AddressType"/> <xs:element ref="D6002_TeYVe" minOccurs="0"/> <xs:element ref="D6011_TETreatment"/> <xs:element ref="D6012_PcentAllowance"/> <xs:element ref="D6013_FixedAllowance"/> </xs:sequence> </xs:extension> </xs:complexContent> </xs:complexType> </pre> | | | | | |

element **DPIDNotificationType/Address**

| | |
|-------------------|--------------------------------------------------------------------------------------------------------------------------------------------------------------------------------------------------------------------------------------------------------------------------------------------------------------------------------------------------------------------------------------------------------------------------------------------------------------------------------------------------------------------------------------|
| <p>diagram</p> | |
| <p>namespace</p> | <p>urn:bridgeall-com:cmaservice:data:v3</p> |
| <p>type</p> | <p>AddressType</p> |
| <p>properties</p> | <p>isRef 0 content complex</p> |
| <p>children</p> | <p>D5001_FreeDescriptor D5002_SubBuildingName D5003_BuildingName D5004_BuildingNumber D5005_DependentThoroughfareName D5006_DependentThoroughfareDescriptor D5007_ThoroughfareName D5008_ThoroughfareDescriptor D5009_DoubleDependentLocality D5010_DependentLocality D5011_PostTown D5012_County D5013_Postcode</p> |
| <p>source</p> | <p><xs:element name="Address" type="AddressType"/></p> |

complexType **DPIDUpdateType**

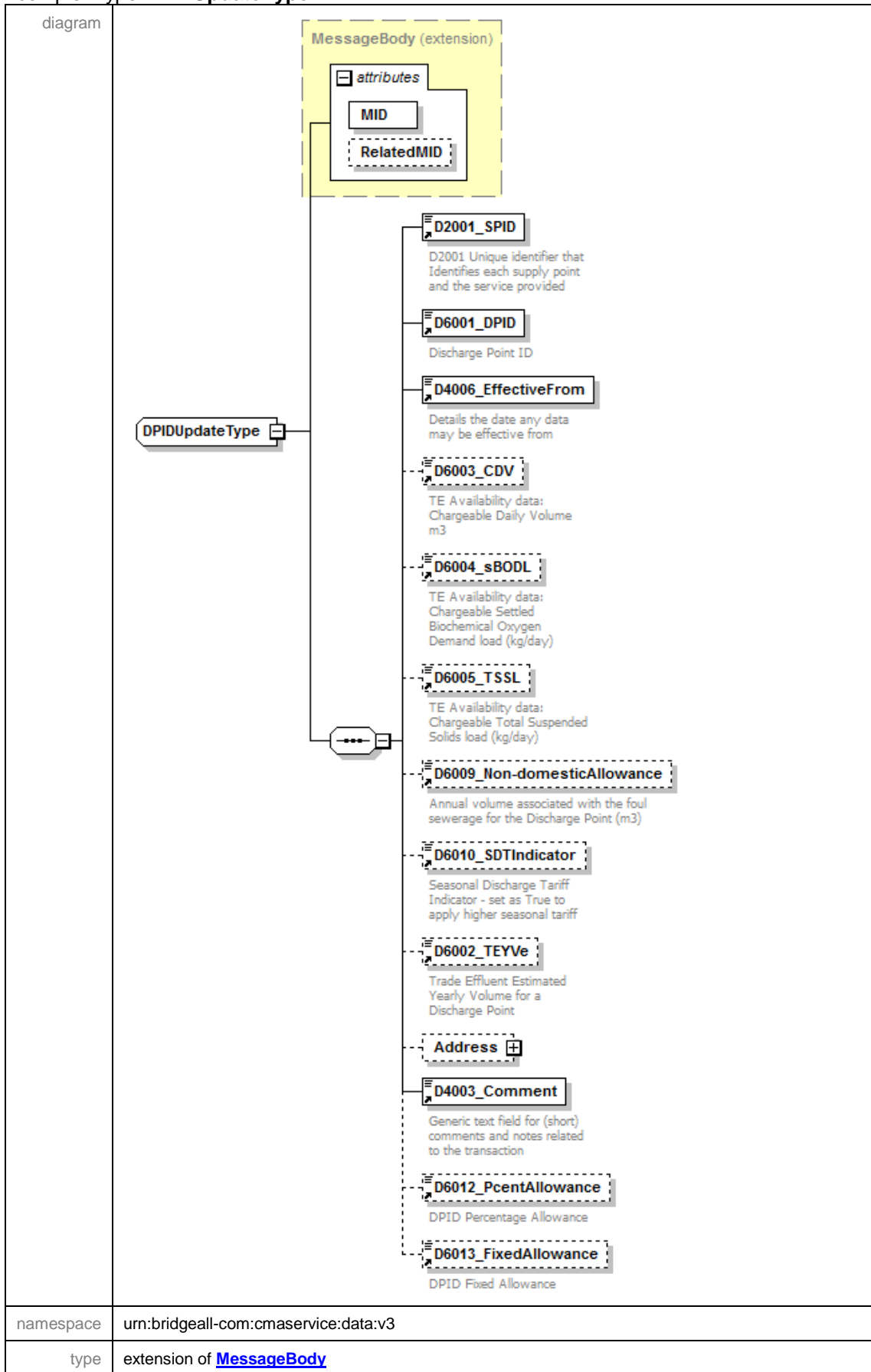

| | | | | | | |
|------------|-------------------------------------------------------------------------------------------------------------------------------------------------------------------------------------------------------------------------------------------------------------------------------------------------------------------------------------------------------------------------------------------------------------------------------------------------------------------------------------------------------------------------------------------------------------------------------------------------------------------------------------------------------------------------------------------------------------------------------------------------------------------------------------------------------------------------------------------------------------------------------------------------------------------------------------------------------------------------------------------------------------------------------------------------------------------------------------------------------------------------------------------------------------------------------------------------------------------------------------------------|-------------------------------|----------|---------|-------|------------|
| properties | base MessageBody | | | | | |
| children | D2001_SPID D6001_DPID D4006_EffectiveFrom D6003_CDV D6004_sBODL D6005_TSSL D6009_Non-domesticAllowance D6010_SDTIndicator D6002_TeYVe Address D4003_Comment D6012_PcentAllowance D6013_FixedAllowance | | | | | |
| used by | elements MessagesType/T027.0_DPIDUpdates/T027.0_DPIDUpdateResponseMessagesType/T027.1_DPIDUpdateNotification | | | | | |
| attributes | Name | Type | Use | Default | Fixed | annotation |
| | MID | MessageIdType | required | | | |
| | RelatedMID | MessageIdType | optional | | | |
| annotation | documentation | | | | | |
| source | <pre> <xs:complexType name="DPIDUpdateType"> <xs:annotation> <xs:documentation> </xs:documentation> </xs:annotation> <xs:complexContent> <xs:extension base="MessageBody"> <xs:sequence> <xs:element ref="D2001_SPID"/> <xs:element ref="D6001_DPID"/> <xs:element ref="D4006_EffectiveFrom"/> <xs:element ref="D6003_CDV" minOccurs="0"/> <xs:element ref="D6004_sBODL" minOccurs="0"/> <xs:element ref="D6005_TSSL" minOccurs="0"/> <xs:element ref="D6009_Non-domesticAllowance" minOccurs="0"/> <xs:element ref="D6010_SDTIndicator" minOccurs="0"/> <xs:element ref="D6002_TeYVe" minOccurs="0"/> <xs:element name="Address" type="AddressType" minOccurs="0"/> <xs:element ref="D4003_Comment"/> <xs:element ref="D6012_PcentAllowance" minOccurs="0"/> <xs:element ref="D6013_FixedAllowance" minOccurs="0"/> </xs:sequence> </xs:extension> </xs:complexContent> </xs:complexType> </pre> | | | | | |

element **DPIDUpdateType/Address**

| | |
|-------------------|--------------------------------------------------------------------------------------------------------------------------------------------------------------------------------------------------------------------------------------------------------------------------------------------------------------------------------------------------------------------------------------------------------------------------------------------------------------------------------------------------------------------------------------|
| <p>diagram</p> | |
| <p>namespace</p> | <p>urn:bridgeall-com:cmaservice:data:v3</p> |
| <p>type</p> | <p>AddressType</p> |
| <p>properties</p> | <p>isRef 0 minOcc 0 maxOcc 1 content complex</p> |
| <p>children</p> | <p>D5001_FreeDescriptor D5002_SubBuildingName D5003_BuildingName D5004_BuildingNumber D5005_DependentThoroughfareName D5006_DependentThoroughfareDescriptor D5007_ThoroughfareName D5008_ThoroughfareDescriptor D5009_DoubleDependentLocality D5010_DependentLocality D5011_PostTown D5012_County D5013_Postcode</p> |
| <p>source</p> | <p><xs:element name="Address" type="AddressType" minOccurs="0"/></p> |

complexType **DPMeterReadType**

| <p>diagram</p> | | | | | | | | | | | | | | | | | | | |
|----------------------------|--------------------------------------------------------------------------------------------------------------------------------------------------------------------------------------------------------------------------------------------------------------------------------------------------------------------------------------------------------------------------------------------------------------------------------------------|----------|---------|-------|------------|-------|------------|---------------------|-------------------------------|----------|--|--|--|----------------------------|-------------------------------|----------|--|--|--|
| <p>namespace</p> | <p>urn:bridgeall-com:cmaservice:data:v3</p> | | | | | | | | | | | | | | | | | | |
| <p>type</p> | <p>extension of MessageBody</p> | | | | | | | | | | | | | | | | | | |
| <p>properties</p> | <p>base MessageBody</p> | | | | | | | | | | | | | | | | | | |
| <p>children</p> | <p>D2001_SPID D6001_DPID D3001_MeterId D3008_MeterRead D3009_MeterReadDate D3010_MeterReadType D3012_ReRead D3021_Rollover_Flag</p> | | | | | | | | | | | | | | | | | | |
| <p>used by</p> | <p>elements ResponseMessagesType/T030.0 DPMeterReadNotification ResponseMessagesType/T030.1 DPMeterReadNotification</p> | | | | | | | | | | | | | | | | | | |
| <p>attributes</p> | <table border="1"> <thead> <tr> <th>Name</th> <th>Type</th> <th>Use</th> <th>Default</th> <th>Fixed</th> <th>annotation</th> </tr> </thead> <tbody> <tr> <td>MID</td> <td>MessageIdType</td> <td>required</td> <td></td> <td></td> <td></td> </tr> <tr> <td>RelatedMID</td> <td>MessageIdType</td> <td>optional</td> <td></td> <td></td> <td></td> </tr> </tbody> </table> | Name | Type | Use | Default | Fixed | annotation | MID | MessageIdType | required | | | | RelatedMID | MessageIdType | optional | | | |
| Name | Type | Use | Default | Fixed | annotation | | | | | | | | | | | | | | |
| MID | MessageIdType | required | | | | | | | | | | | | | | | | | |
| RelatedMID | MessageIdType | optional | | | | | | | | | | | | | | | | | |
| <p>annotation</p> | <p>documentation</p> | | | | | | | | | | | | | | | | | | |
| <p>source</p> | <pre><xs:complexType name="DPMeterReadType"> <xs:annotation></pre> | | | | | | | | | | | | | | | | | | |

```

<xs:documentation>
  </xs:documentation>
</xs:annotation>
<xs:complexContent>
  <xs:extension base="MessageBody">
    <xs:sequence>
      <xs:element ref="D2001_SPID" minOccurs="0"/>
      <xs:element ref="D6001_DPID"/>
      <xs:element ref="D3001_MeterId"/>
      <xs:element ref="D3008_MeterRead"/>
      <xs:element ref="D3009_MeterReadDate"/>
      <xs:element ref="D3010_MeterReadType"/>
      <xs:element ref="D3012_ReRead"/>
      <xs:element ref="D3021_Rollover_Flag"/>
    </xs:sequence>
  </xs:extension>
</xs:complexContent>
</xs:complexType>

```

complexType LPMeterUpdateType

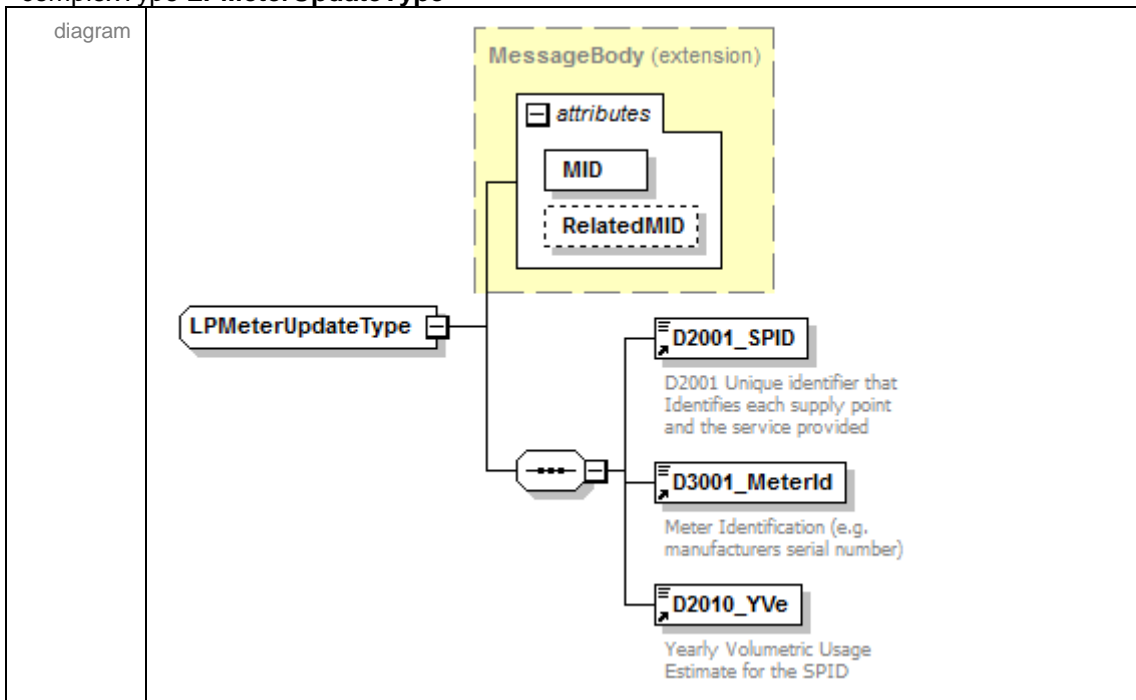

| | | | | | | |
|------------|------------------------------------------------------------------------------------|-------------------------------|----------|---------|-------|------------|
| namespace | urn:bridgeall-com:cmaservice:data:v3 | | | | | |
| type | extension of MessageBody | | | | | |
| properties | base MessageBody | | | | | |
| children | D2001_SPID D3001_MeterId D2010_YVe | | | | | |
| used by | element MessagesType/T004.2 LPMeterUpdates/T004.2 LPMeterUpdate | | | | | |
| attributes | Name | Type | Use | Default | Fixed | annotation |
| | MID | MessageIdType | required | | | |
| | RelatedMID | MessageIdType | optional | | | |
| annotation | documentation | | | | | |
| source | <xs:complexType name="LPMeterUpdateType"> | | | | | |

| | |
|--|---------------------------------------------------------------------------------------------------------------------------------------------------------------------------------------------------------------------------------------------------------------------------------------------------------------------------------------------------------------------------------------------------------------------------------------------------------------------------|
| | <pre> <xs:annotation> <xs:documentation> </xs:documentation> </xs:annotation> <xs:complexContent> <xs:extension base="MessageBody"> <xs:sequence> <xs:element ref="D2001_SPID"/> <xs:element ref="D3001_MeterId"/> <xs:element ref="D2010_YVe"/> </xs:sequence> </xs:extension> </xs:complexContent> </xs:complexType> </pre> |
|--|---------------------------------------------------------------------------------------------------------------------------------------------------------------------------------------------------------------------------------------------------------------------------------------------------------------------------------------------------------------------------------------------------------------------------------------------------------------------------|

complexType **MessageBody**

| | |
|------------|--------------------------------------------------------------------------------------------------------------------------------------------------------------------------------------------------------------------------------------------------------------------------------------------------------------------------------------------------------------------------------------------------------------------------------------------------------------------------------------------------------------------------------------------------------------------------------------------------------------------------------------------------------------------------------------------------------------------------------------------------------------------------------------------------------------------------------------------------------------------------------------------------------------------------------------------------------------------------------------------------------------------------------------------------------------------------------------------------------------------------------------------------------------------------------------------------------------------------------------------------------------------------------------------------------------------------------------------------------------------------------------------------------------------------------------------------------------------------------------------------------------------------------------------------------------------------------------------------------------------------------------------------------------------------------------------------------------------------------------------------------------------------------------------------------------------------------------------------------------------------------------------------------------------------------------------------------------------------------------------------------------------------------------------------------------------------------------------------------------------------------------------------------------------------------------------------------------------------------------------------------------------------------------------------------------------------------------------------------------------------------------------------------------------------------------------------------------------------------------------------------------------------------------------------------------------------------------------------------------------------------------------------------------------------------------------------------------------------------------------------------------------------------------------------------------------------------------------------------------------------------------------------------------------------------------------------------------------------------------------------------------------------------------------------------------------------------------------------------------------------------------------------------------------------------------------------------------------------------------------------------------------------------------------------------------------------------------------------------------|
| diagram | |
| namespace | urn:bridgeall-com:cmaservice:data:v3 |
| properties | abstract true |
| used by | <p>complexTypes</p> <p> CancelRegistrationNotificationOutType CancelRegistrationNotificationType CancelRegistrationType ChargeableMeterUpdateType ConnectionCompleteType CustomerNameUpdatedNotificationType DisconnectionType DiscontinueDPIDType DPIDNotificationType DPIDUpdateType DPMeterReadType LPMeterUpdateType MeterAssociationType MeterDisAssociationType MeterNetworkAssociationType MeterReadNotificationType MeterReadType MeterSwapNotificationType MeterSwapType MeterUpdateNotificationType MeterUpdateType NewLPSPIDNotificationType NewSPIDNotificationType NewSPIDRequestType NotificationType NotifyRSDType PartialRegistrationApplicationType PremisesSpecialArrangementsUpdateNotificationType PremisesSpecialArrangementsUpdateType RegistrationStartType Schedule3UpdateType ServiceElementUpdateNotificationType SewerageServiceElementUpdateNotificationType SewerageSPIDDataType SpecialArrangementsUpdateNotificationType SpecialArrangementsUpdateType T003.1 RegistrationApplicationType T004.0 NewMeterType T004.1 NewMeterNotificationType T004.3 VirtualMeterType T006.0 LPWaterSPIDUpdateType T006.1 LPSewerageSPIDUpdateType T006.2 WaterSPIDUpdateType T006.3 SewerageSPIDUpdateType T006.4 WaterSPIDNotificationType T006.5 SewerageSPIDNotificationType T006.6 ProvideLiveRateableValueType T006.7 ProvideLiveRateableValueNotificationType T007.0 WaterConnectionCompleteType T009.4 NotificationType T012.0 MiscSPIDUpdateType T012.1 ServiceElementUpdateType T012.3 SewerageServiceElementUpdateType T012.7 UpdateLiveRateableValueType T012.8 UpdateLiveRateableValueNotificationType T016.0 UnmeasureableDeclarationType T032.0 CreateUpdateCustomerNameType T032.1 CustomerNameUpdatedType T033.0 MeteredBuilding T033.1 MeteredBuildingUpdate T034.0 VacSchemeApplication T034.1 VacSchemeGracePeriodNotification T034.2 VacSchemeGraceEndNotification T034.3 VacSchemeApplicationNotification T034.4 VacSchemeApplicationConfirmationOrCancellation T034.5 VacSchemeApplicationConfirmationOrCancellationNotification T035.0 TradeabilityNotification T035.1 TradeabilityNotification TEUpdateType UpdateMeterLocationNotificationType </p> |

| | | | | | | |
|------------|---------------------------------------------------------------------------------------------------------------------------------------------------------------------------------------------------------------------------------------------------|-------------------------------|----------|---------|-------|------------|
| | UpdateMeterLocationType UpdateSAAReferenceNumberUPRNNotificationType UpdateSAAReferenceNumberUPRNType WaterSPIDDataType | | | | | |
| attributes | Name | Type | Use | Default | Fixed | annotation |
| | MID | MessageIdType | required | | | |
| | RelatedMID | MessageIdType | optional | | | |
| source | <pre><xs:complexType name="MessageBody" abstract="true"> <xs:attribute name="MID" type="MessageIdType" use="required"/> <xs:attribute name="RelatedMID" type="MessageIdType" use="optional"/> </xs:complexType></pre> | | | | | |

attribute **MessageBody/@MID**

| | | | | | | |
|------------|---------------------------------------------------------------------------------|------------------------|-----|----------|------------|--|
| type | MessageIdType | | | | | |
| properties | isRef | 0 | use | required | | |
| facets | Kind | Value | | | annotation | |
| | minLength | 16 | | | | |
| | maxLength | 16 | | | | |
| | pattern | ([a-z][[A-Z]][[0-9]]*) | | | | |
| source | <pre><xs:attribute name="MID" type="MessageIdType" use="required"/></pre> | | | | | |

attribute **MessageBody/@RelatedMID**

| | | | | | | |
|------------|----------------------------------------------------------------------------------------|------------------------|-----|----------|------------|--|
| type | MessageIdType | | | | | |
| properties | isRef | 0 | use | optional | | |
| facets | Kind | Value | | | annotation | |
| | minLength | 16 | | | | |
| | maxLength | 16 | | | | |
| | pattern | ([a-z][[A-Z]][[0-9]]*) | | | | |
| source | <pre><xs:attribute name="RelatedMID" type="MessageIdType" use="optional"/></pre> | | | | | |

complexType **MessagesType**

| | |
|------------------|--------------------------------------------------------------------------------------------------------------------------------------------------------------------------------------------------------------------------------------------------------------------------------------------------------------------------------------------------------------------------------------------------------------------------------------------------------------------------------------------------------------------------------------------------------------------------------------------------------------------------------------------------------------------------------------------------------------------------------------------------------------------------------------------------------------------------------------------------------------------------------------------------------------------------------------------------------------------------------------------------------------------------------------------------------------------------------------------------------------------------------------------------------------------------------------------------------------------------------------------------------------------------------------------------------------------------------------------------------------------------------------------------------------------------------------------------------------------------------------------------------------------------------------------------------------------------------------------------------------------------------------------------------------------------------------------------------------------------------------------------------------------------------------------------------------------------------------------------------------------------------------------------------------------------------------------------------------------------------------------------------------------|
| <p>diagram</p> | <p>The diagram illustrates the structure of the MessagesType complex type. It contains a list of 48 message types, each represented by a box with a plus sign icon. A separate box labeled 'MessagesType' is connected to the list by a line with a plus sign icon, indicating that this complex type contains all the listed messages.</p> <ul style="list-style-type: none"> T001.0_NewSPIDRequests T003.0_PartialRegistrationAppli... T003.1_RegistrationApplications T004.0_NewMeters T004.2_LPMeterUpdates T004.3_VirtualMeters T005.0_SWMeterReads T005.1_LPMeterReads T006.0_LPWaterSPIDUpdates T006.1_LPSewerageSPIDUpdates T006.2_WaterSPIDUpdates T006.3_SewerageSPIDUpdates T006.6_ProvideLiveRateableVal... T007.0_WaterConnectionCompl... T007.1_SewerageConnectionC... T009.2_Notifications T009.3_Notifications T010.0_CancelRegistrationInco... T010.1_CancelRegistrationOutg... T012.0_MiscSPIDUpdates T012.1_ServiceElementUpdates T012.3_SewerageServiceEleme... T012.5_UpdateSAAReferenceNu... T012.7_UpdateLiveRateableValu... T013.0_MeterUpdates T013.2_UpdateMeterLocations T014.0_ChargeableMeterUpdates T015.0_DisconnectionDeclaratio... T016.0_UnmeasureableDeclarat... T017.0_MeterSwaps T021.0_NewDPIDs T022.0_TEUpdates T023.0_MeterAssociations T024.0_MeterDisAssociations T026.0_DiscontinueDPIDs T027.0_DPIDUpdates T028.1_Schedule3Updates T029.1_SpecialArrangementsU... T029.3_PremisesSpecialArrang... T032.0_CreateUpdateCustomer... T033.0_MeteredBuildings T034.0_VacSchemeApplications T034.4_VacSchemeApplication... T036.0_MeterNetworkAssociati... |
| <p>namespace</p> | <p>urn:bridgeall-com:cmaservice:data:v3</p> |
| <p>children</p> | <p>T001.0_NewSPIDRequests T003.0_PartialRegistrationApplications T003.1_RegistrationApplications T004.0_NewMeters T004.2_LPMeterUpdates</p> |

| | |
|---------|-----------------------------------------------------------------------------------------------------------------------------------------------------------------------------------------------------------------------------------------------------------------------------------------------------------------------------------------------------------------------------------------------------------------------------------------------------------------------------------------------------------------------------------------------------------------------------------------------------------------------------------------------------------------------------------------------------------------------------------------------------------------------------------------------------------------------------------------------------------------------------------------------------------------------------------------------------------------------------------------------------------------------------------------------------------------------------------------------------------------------------------------------------------------------------------------------------------------------------------------------------------------------------------------------------------------------------------------------------------------------------------------------------------------------------------------------------------------------------------------------------------------------------------------------------------------------------------------------------------------------------------------------------------------------------------------------------------------------------------------------------------------------------------------------------------------------------------------------|
| | T004.3 VirtualMeters T005.0 SWMeterReads T005.1 LPMeterReads T006.0 LPWaterSPIDUpdates T006.1 LPsewageSPIDUpdates T006.2 WaterSPIDUpdates T006.3 SewerageSPIDUpdates T006.6 ProvideLiveRateableValues T007.0 WaterConnectionCompletes T007.1 SewerageConnectionCompletes T009.2 Notifications T009.3 Notifications T010.0 CancelRegistrationIncomings T010.1 CancelRegistrationOutgoings T012.0 MiscSPIDUpdates T012.1 ServiceElementUpdates T012.3 SewerageServiceElementUpdates T012.5 UpdateSAAReferenceNumberUPRNs T012.7 UpdateLiveRateableValues T013.0 MeterUpdates T013.2 UpdateMeterLocations T014.0 ChargeableMeterUpdates T015.0 DisconnectionDeclarations T016.0 UnmeasureableDeclarations T017.0 MeterSwaps T021.0 NewDPIDs T022.0 TEUpdates T023.0 MeterAssociations T024.0 MeterDisAssociations T026.0 DiscontinueDPIDs T027.0 DPIDUpdates T028.1 Schedule3Updates T029.1 SpecialArrangementsUpdates T029.3 PremisesSpecialArrangementsUpdates T032.0 CreateUpdateCustomerName T033.0 MeteredBuildings T034.0 VacSchemeApplications T034.4 VacSchemeApplicationConfirmationOrCancellations T036.0 MeterNetworkAssociations |
| used by | element Messages |
| source | <pre> <xs:complexType name="MessagesType"> <xs:choice> <xs:element name="T001.0_NewSPIDRequests"> <xs:complexType> <xs:sequence maxOccurs="unbounded"> <xs:element name="T001.0_NewSPIDRequest" type="NewSPIDRequestType"/> </xs:sequence> </xs:complexType> </xs:element> <xs:element name="T003.0_PartialRegistrationApplications"> <xs:complexType> <xs:sequence maxOccurs="unbounded"> <xs:element name="T003.0_PartialRegistrationApplication" type="PartialRegistrationApplicationType"/> </xs:sequence> </xs:complexType> </xs:element> <xs:element name="T003.1_RegistrationApplications"> <xs:complexType> <xs:sequence maxOccurs="unbounded"> <xs:element name="T003.1_RegistrationApplication" type="T003.1_RegistrationApplicationType"/> </xs:sequence> </xs:complexType> </xs:element> <xs:element name="T004.0_NewMeters"> <xs:complexType> <xs:sequence maxOccurs="unbounded"> <xs:element name="T004.0_NewMeter" type="T004.0_NewMeterType"/> </xs:sequence> </xs:complexType> </xs:element> <xs:element name="T004.2_LPMeterUpdates"> <xs:complexType> <xs:sequence maxOccurs="unbounded"> <xs:element name="T004.2_LPMeterUpdate" type="LPMeterUpdateType"/> </xs:sequence> </xs:complexType> </xs:element> <xs:element name="T004.3_VirtualMeters"> <xs:complexType> <xs:sequence maxOccurs="unbounded"> </pre> |

```

        <xs:element name="T004.3_VirtualMeter"
type="T004.3_VirtualMeterType"/>
    </xs:sequence>
</xs:complexType>
</xs:element>
<xs:element name="T005.0_SWMeterReads">
    <xs:complexType>
        <xs:sequence maxOccurs="unbounded">
            <xs:element name="T005.0_SWMeterRead" type="MeterReadType"/>
        </xs:sequence>
    </xs:complexType>
</xs:element>
<xs:element name="T005.1_LPMeterReads">
    <xs:complexType>
        <xs:sequence maxOccurs="unbounded">
            <xs:element name="T005.1_LPMeterRead" type="MeterReadType"/>
        </xs:sequence>
    </xs:complexType>
</xs:element>
<xs:element name="T006.0_LPWaterSPIDUpdates">
    <xs:complexType>
        <xs:sequence maxOccurs="unbounded">
            <xs:element name="T006.0_LPWaterSPIDUpdate"
type="T006.0_LPWaterSPIDUpdateType"/>
        </xs:sequence>
    </xs:complexType>
</xs:element>
<xs:element name="T006.1_LPSewerageSPIDUpdates">
    <xs:complexType>
        <xs:sequence maxOccurs="unbounded">
            <xs:element name="T006.1_LPSewerageSPIDUpdate"
type="T006.1_LPSewerageSPIDUpdateType"/>
        </xs:sequence>
    </xs:complexType>
</xs:element>
<xs:element name="T006.2_WaterSPIDUpdates">
    <xs:complexType>
        <xs:sequence maxOccurs="unbounded">
            <xs:element name="T006.2_WaterSPIDUpdate"
type="T006.2_WaterSPIDUpdateType"/>
        </xs:sequence>
    </xs:complexType>
</xs:element>
<xs:element name="T006.3_SewerageSPIDUpdates">
    <xs:complexType>
        <xs:sequence maxOccurs="unbounded">
            <xs:element name="T006.3_SewerageSPIDUpdate"
type="T006.3_SewerageSPIDUpdateType"/>
        </xs:sequence>
    </xs:complexType>
</xs:element>
<xs:element name="T006.6_ProvideLiveRateableValues">
    <xs:complexType>
        <xs:sequence maxOccurs="unbounded">
            <xs:element name="T006.6_ProvideLiveRateableValue"
type="T006.6_ProvideLiveRateableValueType"/>
        </xs:sequence>
    </xs:complexType>
</xs:element>

```

```

<xs:element name="T007.0_WaterConnectionCompletes">
  <xs:complexType>
    <xs:sequence maxOccurs="unbounded">
      <xs:element name="T007.0_WaterConnectionComplete"
type="T007.0_WaterConnectionCompleteType"/>
    </xs:sequence>
  </xs:complexType>
</xs:element>
<xs:element name="T007.1_SewerageConnectionCompletes">
  <xs:complexType>
    <xs:sequence maxOccurs="unbounded">
      <xs:element name="T007.1_SewerageConnectionComplete"
type="ConnectionCompleteType"/>
    </xs:sequence>
  </xs:complexType>
</xs:element>
<xs:element name="T009.2_Notifications">
  <xs:complexType>
    <xs:sequence maxOccurs="unbounded">
      <xs:element name="T009.2_Notification" type="NotificationType"/>
    </xs:sequence>
  </xs:complexType>
</xs:element>
<xs:element name="T009.3_Notifications">
  <xs:complexType>
    <xs:sequence maxOccurs="unbounded">
      <xs:element name="T009.3_Notification" type="NotificationType"/>
    </xs:sequence>
  </xs:complexType>
</xs:element>
<xs:element name="T010.0_CancelRegistrationIncomings">
  <xs:complexType>
    <xs:sequence maxOccurs="unbounded">
      <xs:element name="T010.0_CancelRegistrationIncoming"
type="CancelRegistrationType"/>
    </xs:sequence>
  </xs:complexType>
</xs:element>
<xs:element name="T010.1_CancelRegistrationOutgoings">
  <xs:complexType>
    <xs:sequence maxOccurs="unbounded">
      <xs:element name="T010.1_CancelRegistrationOutgoing"
type="CancelRegistrationOutType"/>
    </xs:sequence>
  </xs:complexType>
</xs:element>
<xs:element name="T012.0_MiscSPIDUpdates">
  <xs:complexType>
    <xs:sequence maxOccurs="unbounded">
      <xs:element name="T012.0_MiscSPIDUpdate"
type="T012.0_MiscSPIDUpdateType"/>
    </xs:sequence>
  </xs:complexType>
</xs:element>
<xs:element name="T012.1_ServiceElementUpdates">
  <xs:complexType>
    <xs:sequence maxOccurs="unbounded">
      <xs:element name="T012.1_ServiceElementUpdate"
type="T012.1_ServiceElementUpdateType"/>
    </xs:sequence>
  </xs:complexType>
</xs:element>

```

```

</xs:sequence>
</xs:complexType>
</xs:element>
<xs:element name="T012.3_SewerageServiceElementUpdates">
  <xs:complexType>
    <xs:sequence maxOccurs="unbounded">
      <xs:element name="T012.3_SewerageServiceElementUpdate"
type="T012.3_SewerageServiceElementUpdateType"/>
    </xs:sequence>
  </xs:complexType>
</xs:element>
<xs:element name="T012.5_UpdateSAAReferenceNumberUPRNs">
  <xs:complexType>
    <xs:sequence maxOccurs="unbounded">
      <xs:element name="T012.5_UpdateSAAReferenceNumberUPRN"
type="UpdateSAAReferenceNumberUPRNTYPE"/>
    </xs:sequence>
  </xs:complexType>
</xs:element>
<xs:element name="T012.7_UpdateLiveRateableValues">
  <xs:complexType>
    <xs:sequence maxOccurs="unbounded">
      <xs:element name="T012.7_UpdateLiveRateableValue"
type="T012.7_UpdateLiveRateableValueType"/>
    </xs:sequence>
  </xs:complexType>
</xs:element>
<xs:element name="T013.0_MeterUpdates">
  <xs:complexType>
    <xs:sequence maxOccurs="unbounded">
      <xs:element name="T013.0_MeterUpdate" type="MeterUpdateType"/>
    </xs:sequence>
  </xs:complexType>
</xs:element>
<xs:element name="T013.2_UpdateMeterLocations">
  <xs:complexType>
    <xs:sequence maxOccurs="unbounded">
      <xs:element name="T013.2_UpdateMeterLocation"
type="UpdateMeterLocationType"/>
    </xs:sequence>
  </xs:complexType>
</xs:element>
<xs:element name="T014.0_ChargeableMeterUpdates">
  <xs:complexType>
    <xs:sequence maxOccurs="unbounded">
      <xs:element name="T014.0_ChargeableMeterUpdate"
type="ChargeableMeterUpdateType"/>
    </xs:sequence>
  </xs:complexType>
</xs:element>
<xs:element name="T015.0_DisconnectionDeclarations">
  <xs:complexType>
    <xs:sequence maxOccurs="unbounded">
      <xs:element name="T015.0_DisconnectionDeclaration"
type="DisconnectionType"/>
    </xs:sequence>
  </xs:complexType>
</xs:element>
<xs:element name="T016.0_UnmeasureableDeclarations">

```

```

<xs:complexType>
  <xs:sequence maxOccurs="unbounded">
    <xs:element name="T016.0_UnmeasureableDeclaration"
type="T016.0_UnmeasureableDeclarationType"/>
  </xs:sequence>
</xs:complexType>
</xs:element>
<xs:element name="T017.0_MeterSwaps">
  <xs:complexType>
    <xs:sequence maxOccurs="unbounded">
      <xs:element name="T017.0_MeterSwap" type="MeterSwapType"/>
    </xs:sequence>
  </xs:complexType>
</xs:element>
<xs:element name="T021.0_NewDPIDs">
  <xs:complexType>
    <xs:sequence maxOccurs="unbounded">
      <xs:element name="T021.0_NewDPID" type="DPIDNotificationType"/>
    </xs:sequence>
  </xs:complexType>
</xs:element>
<xs:element name="T022.0_TEUpdates">
  <xs:complexType>
    <xs:sequence maxOccurs="unbounded">
      <xs:element name="T022.0_TEUpdate" type="TEUpdateType"/>
    </xs:sequence>
  </xs:complexType>
</xs:element>
<xs:element name="T023.0_MeterAssociations">
  <xs:complexType>
    <xs:sequence maxOccurs="unbounded">
      <xs:element name="T023.0_MeterAssociation"
type="MeterAssociationType"/>
    </xs:sequence>
  </xs:complexType>
</xs:element>
<xs:element name="T024.0_MeterDisAssociations">
  <xs:complexType>
    <xs:sequence maxOccurs="unbounded">
      <xs:element name="T024.0_MeterDisAssociation"
type="MeterDisAssociationType"/>
    </xs:sequence>
  </xs:complexType>
</xs:element>
<xs:element name="T026.0_DiscontinuedDPIDs">
  <xs:complexType>
    <xs:sequence maxOccurs="unbounded">
      <xs:element name="T026.0_DiscontinueDPID"
type="DiscontinueDPIDType"/>
    </xs:sequence>
  </xs:complexType>
</xs:element>
<xs:element name="T027.0_DPIDUpdates">
  <xs:complexType>
    <xs:sequence maxOccurs="unbounded">
      <xs:element name="T027.0_DPIDUpdate" type="DPIDUpdateType"/>
    </xs:sequence>
  </xs:complexType>
</xs:element>

```

```

<xs:element name="T028.1_Schedule3Updates">
  <xs:complexType>
    <xs:sequence maxOccurs="unbounded">
      <xs:element name="T028.1_Schedule3Update"
type="Schedule3UpdateType"/>
    </xs:sequence>
  </xs:complexType>
</xs:element>
<xs:element name="T029.1_SpecialArrangementsUpdates">
  <xs:complexType>
    <xs:sequence maxOccurs="unbounded">
      <xs:element name="T029.1_SpecialArrangementsUpdate"
type="SpecialArrangementsUpdateType"/>
    </xs:sequence>
  </xs:complexType>
</xs:element>
<xs:element name="T029.3_PremisesSpecialArrangementsUpdates">
  <xs:complexType>
    <xs:sequence maxOccurs="unbounded">
      <xs:element name="T029.3_PremisesSpecialArrangementsUpdate"
type="PremisesSpecialArrangementsUpdateType"/>
    </xs:sequence>
  </xs:complexType>
</xs:element>
<xs:element name="T032.0_CreateUpdateCustomerName">
  <xs:complexType>
    <xs:sequence maxOccurs="unbounded">
      <xs:element name="T032.0_CreateUpdateCustomerName"
type="T032.0_CreateUpdateCustomerNameType"/>
    </xs:sequence>
  </xs:complexType>
</xs:element>
<xs:element name="T033.0_MeteredBuildings">
  <xs:complexType>
    <xs:sequence maxOccurs="unbounded">
      <xs:element name="T033.0_MeteredBuilding"
type="T033.0_MeteredBuilding"/>
    </xs:sequence>
  </xs:complexType>
</xs:element>
<xs:element name="T034.0_VacSchemeApplications">
  <xs:complexType>
    <xs:sequence maxOccurs="unbounded">
      <xs:element name="T034.0_VacSchemeApplication"
type="T034.0_VacSchemeApplication"/>
    </xs:sequence>
  </xs:complexType>
</xs:element>
<xs:element
name="T034.4_VacSchemeApplicationConfirmationOrCancellations">
  <xs:complexType>
    <xs:sequence maxOccurs="unbounded">
      <xs:element
name="T034.4_VacSchemeApplicationConfirmationOrCancellation"
type="T034.4_VacSchemeApplicationConfirmationOrCancellation"/>
    </xs:sequence>
  </xs:complexType>
</xs:element>
<xs:element name="T036.0_MeterNetworkAssociations">

```

| | |
|--|------------------------------------------------------------------------------------------------------------------------------------------------------------------------------------------------------------------------------------------------------------------------------------------------|
| | <pre> <xs:complexType> <xs:sequence maxOccurs="unbounded"> <xs:element name="T036.0_MeterNetworkAssociation" type="MeterNetworkAssociationType"/> </xs:sequence> </xs:complexType> </xs:element> </xs:choice> </xs:complexType> </pre> |
|--|------------------------------------------------------------------------------------------------------------------------------------------------------------------------------------------------------------------------------------------------------------------------------------------------|

element **MessagesType/T001.0_NewSPIDRequests**

| | |
|------------|----------------------------------------------------------------------------------------------------------------------------------------------------------------------------------------------------------------------------------------------------------------------------------------------|
| diagram | <p>The diagram shows a container box labeled 'T001.0_NewSPIDRequests' connected to a sequence box containing three dots and a plus sign, which is then connected to a box labeled 'T001.0_NewSPIDRequest'. Below the sequence box is the cardinality '1..∞'.</p> |
| namespace | urn:bridgeall-com:cmaservice:data:v3 |
| properties | isRef 0 content complex |
| children | T001.0_NewSPIDRequest |
| source | <pre> <xs:element name="T001.0_NewSPIDRequests"> <xs:complexType> <xs:sequence maxOccurs="unbounded"> <xs:element name="T001.0_NewSPIDRequest" type="NewSPIDRequestType"/> </xs:sequence> </xs:complexType> </xs:element> </pre> |

element **MessagesType/T001.0_NewSPIDRequests/T001.0_NewSPIDRequest**

| <p>diagram</p> | | | | | | | | | | | | | | | | | | | |
|----------------------------|--------------------------------------------------------------------------------------------------------------------------------------------------------------------------------------------------------------------------------------------------------------------------------------------------------------------------------------------------------------------------------------------------------------------------------------------|----------|---------|-------|------------|-------|------------|---------------------|-------------------------------|----------|--|--|--|----------------------------|-------------------------------|----------|--|--|--|
| <p>namespace</p> | <p>urn:bridgeall-com:cmaservice:data:v3</p> | | | | | | | | | | | | | | | | | | |
| <p>type</p> | <p>NewSPIDRequestType</p> | | | | | | | | | | | | | | | | | | |
| <p>properties</p> | <p>isRef 0 content complex</p> | | | | | | | | | | | | | | | | | | |
| <p>children</p> | <p>D2001_SPID D2009_SWConnectionRef D2043_LPConnectionRef D4001_OrgId D2002_ServiceCategory SPIDLocation D2023_NewConnectionType UARNDData UPRNDData</p> | | | | | | | | | | | | | | | | | | |
| <p>attributes</p> | <table border="1"> <thead> <tr> <th>Name</th> <th>Type</th> <th>Use</th> <th>Default</th> <th>Fixed</th> <th>annotation</th> </tr> </thead> <tbody> <tr> <td>MID</td> <td>MessageIdType</td> <td>required</td> <td></td> <td></td> <td></td> </tr> <tr> <td>RelatedMID</td> <td>MessageIdType</td> <td>optional</td> <td></td> <td></td> <td></td> </tr> </tbody> </table> | Name | Type | Use | Default | Fixed | annotation | MID | MessageIdType | required | | | | RelatedMID | MessageIdType | optional | | | |
| Name | Type | Use | Default | Fixed | annotation | | | | | | | | | | | | | | |
| MID | MessageIdType | required | | | | | | | | | | | | | | | | | |
| RelatedMID | MessageIdType | optional | | | | | | | | | | | | | | | | | |
| <p>source</p> | <p><xs:element name="T001.0_NewSPIDRequest" type="NewSPIDRequestType"/></p> | | | | | | | | | | | | | | | | | | |

element **MessagesType/T003.0_PartialRegistrationApplications**

| | |
|------------|----------------------------------------------------------------------------------------------------------------------------------------------------------------------------------------------------------------------------------------------------------------------------------------------------------------------------------------------------|
| diagram |  |
| namespace | urn:bridgeall-com:cmaservice:data:v3 |
| properties | isRef 0 content complex |
| children | T003.0_PartialRegistrationApplication |
| source | <pre><xs:element name="T003.0_PartialRegistrationApplications"> <xs:complexType> <xs:sequence maxOccurs="unbounded"> <xs:element name="T003.0_PartialRegistrationApplication" type="PartialRegistrationApplicationType"/> </xs:sequence> </xs:complexType> </xs:element></pre> |

element **MessagesType/T003.0_PartialRegistrationApplications/T003.0_PartialRegistrationApplication**

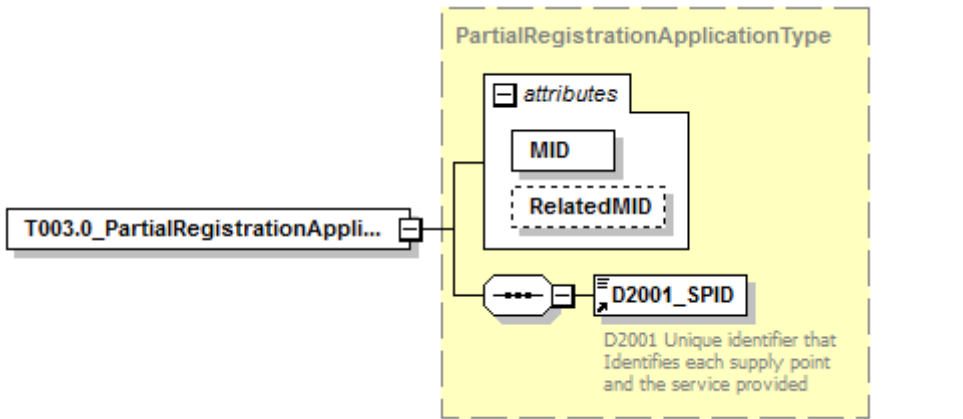
| diagram |  | | | | | | | | | | | | | | | | | | |
|----------------------------|--------------------------------------------------------------------------------------------------------------------------------------------------------------------------------------------------------------------------------------------------------------------------------------------------------------------------------------------------------------------------------------------------------------------------------------------|----------|---------|-------|------------|-------|------------|---------------------|-------------------------------|----------|--|--|--|----------------------------|-------------------------------|----------|--|--|--|
| namespace | urn:bridgeall-com:cmaservice:data:v3 | | | | | | | | | | | | | | | | | | |
| type | PartialRegistrationApplicationType | | | | | | | | | | | | | | | | | | |
| properties | isRef 0 content complex | | | | | | | | | | | | | | | | | | |
| children | D2001_SPID | | | | | | | | | | | | | | | | | | |
| attributes | <table border="1"> <thead> <tr> <th>Name</th> <th>Type</th> <th>Use</th> <th>Default</th> <th>Fixed</th> <th>annotation</th> </tr> </thead> <tbody> <tr> <td>MID</td> <td>MessageIdType</td> <td>required</td> <td></td> <td></td> <td></td> </tr> <tr> <td>RelatedMID</td> <td>MessageIdType</td> <td>optional</td> <td></td> <td></td> <td></td> </tr> </tbody> </table> | Name | Type | Use | Default | Fixed | annotation | MID | MessageIdType | required | | | | RelatedMID | MessageIdType | optional | | | |
| Name | Type | Use | Default | Fixed | annotation | | | | | | | | | | | | | | |
| MID | MessageIdType | required | | | | | | | | | | | | | | | | | |
| RelatedMID | MessageIdType | optional | | | | | | | | | | | | | | | | | |
| source | <pre><xs:element name="T003.0_PartialRegistrationApplication" type="PartialRegistrationApplicationType"/></pre> | | | | | | | | | | | | | | | | | | |

element **MessagesType/T003.1_RegistrationApplications**

| | |
|---------|--------------------------------------------------------------------------------------|
| diagram |  |
|---------|--------------------------------------------------------------------------------------|

| | |
|------------|------------------------------------------------------------------------------------------------------------------------------------------------------------------------------------------------------------------------------------------------------------------------------------------------------------------------------|
| namespace | urn:bridgeall-com:cmaservice:data:v3 |
| properties | isRef 0 content complex |
| children | T003.1_RegistrationApplication |
| source | <pre><xs:element name="T003.1_RegistrationApplications"> <xs:complexType> <xs:sequence maxOccurs="unbounded"> <xs:element name="T003.1_RegistrationApplication" type="T003.1_RegistrationApplicationType"/> </xs:sequence> </xs:complexType> </xs:element></pre> |

element

MessagesType/T003.1_RegistrationApplications/T003.1_RegistrationApplication

| diagram | <p>The diagram shows a class T003.1_RegistrationApplicationType with a dashed border. It contains an attributes compartment with four elements: MID (solid box), RelatedMID (dashed box), D2001_SPID (solid box with a small icon), and D4002_RegistrationStartDate (solid box with a small icon). Below the last two elements are descriptive text blocks: "D2001 Unique identifier that Identifies each supply point and the service provided" and "D4002 Date SPID becomes registered to a Licensed Provider". To the left, a box labeled T003.1_RegistrationApplication is connected to the T003.1_RegistrationApplicationType box by a line with an open arrowhead pointing towards the type.</p> | | | | | | | | | | | | | | | | | | |
|----------------------------|----------------------------------------------------------------------------------------------------------------------------------------------------------------------------------------------------------------------------------------------------------------------------------------------------------------------------------------------------------------------------------------------------------------------------------------------------------------------------------------------------------------------------------------------------------------------------------------------------------------------------------------------------------------------------------------------------------------------------------------------------------------|----------|---------|-------|------------|-------|------------|---------------------|-------------------------------|----------|--|--|--|----------------------------|-------------------------------|----------|--|--|--|
| namespace | urn:bridgeall-com:cmaservice:data:v3 | | | | | | | | | | | | | | | | | | |
| type | T003.1_RegistrationApplicationType | | | | | | | | | | | | | | | | | | |
| properties | isRef 0 content complex | | | | | | | | | | | | | | | | | | |
| children | D2001_SPID D4002_RegistrationStartDate | | | | | | | | | | | | | | | | | | |
| attributes | <table border="1"> <thead> <tr> <th>Name</th> <th>Type</th> <th>Use</th> <th>Default</th> <th>Fixed</th> <th>annotation</th> </tr> </thead> <tbody> <tr> <td>MID</td> <td>MessageIdType</td> <td>required</td> <td></td> <td></td> <td></td> </tr> <tr> <td>RelatedMID</td> <td>MessageIdType</td> <td>optional</td> <td></td> <td></td> <td></td> </tr> </tbody> </table> | Name | Type | Use | Default | Fixed | annotation | MID | MessageIdType | required | | | | RelatedMID | MessageIdType | optional | | | |
| Name | Type | Use | Default | Fixed | annotation | | | | | | | | | | | | | | |
| MID | MessageIdType | required | | | | | | | | | | | | | | | | | |
| RelatedMID | MessageIdType | optional | | | | | | | | | | | | | | | | | |
| source | <pre><xs:element name="T003.1_RegistrationApplication" type="T003.1_RegistrationApplicationType"/></pre> | | | | | | | | | | | | | | | | | | |

element MessagesType/T004.0_NewMeters

| | |
|------------|-------------------------------------------------------------------------------------------------------------------------------------------------------------------------------------------------------------------------------------------------|
| diagram | <p>The diagram shows a box labeled T004.0_NewMeters connected to a box labeled T004.0_NewMeter by a line with an open arrowhead pointing towards T004.0_NewMeter. Below the arrowhead is the multiplicity 1..∞.</p> |
| namespace | urn:bridgeall-com:cmaservice:data:v3 |
| properties | isRef 0 |

| | |
|----------|-----------------------------------------------------------------------------------------------------------------------------------------------------------------------------------------------------------------------------------------------------------------------------------|
| | content complex |
| children | T004.0_NewMeter |
| source | <pre> <xs:element name="T004.0_NewMeters"> <xs:complexType> <xs:sequence maxOccurs="unbounded"> <xs:element name="T004.0_NewMeter" type="T004.0_NewMeterType"/> </xs:sequence> </xs:complexType> </xs:element> </pre> |

element **MessagesType/T004.0_NewMeters/T004.0_NewMeter**

| | |
|------------------|------------------------------------------------------------------------------------------------------------------------------------------------------------------------------------------------------------------------------------------------------------------------------------------------------------------------------------------------------------------------------------------------------------------------------------------------------------------------------------------------------------------------------------------------------------------------------------------------------------------------------------------------------------------------------------------------------------------------------------------------------------------------------------------------------------------------------------------------------------------------------------------------------------------------------------------------------------------------------------------------------------------------------------------------------------------------------------------------------------------------------------------------------------------------------------------------------------------------------------------------------------------------------------------------------------------------------------------------------------------------------------------------------------------------------------------------------------------------------------------------------------------------------------------------------------------------------------------------------------------------------------------------------------------------------------------------------------------------------------------------------------------------------------------------------------------------------------------------------------------------------------------------------------------------------------------------------|
| <p>diagram</p> | <p>T004.0_NewMeterType</p> <ul style="list-style-type: none"> attributes <ul style="list-style-type: none"> MID RelatedMID D2001_SPID: D2001 Unique identifier that identifies each supply point and the service provided D3001_MeterId: Meter Identification (e.g. manufacturers serial number) D3004_NrDigits: The number of digits on the meter register MeterLocation D3003_PhysicalMeterSize: Actual size of a meter (mm) D3002_ChargeableMeterSize: Meter size for tariff charge calculation purposes (mm) D3005_SewerageChargeableMet...: The chargeable size for the Related Water Supply Meter for calculations of Sewerage tariff D3011_MeterReadFrequency: The frequency that the LP must read a meter D3007_ReturnToSewerAllowance: Return to sewer allowance for a particular meter D3013_MeterMake: Meter Make D3014_ManufacturerMeterSerial...: Meter Serial Number D3015_datalogger_SW: Specifies the presence of a Scottish Water datalogger D3016_datalogger_NonSW: Specifies the presence of a non Scottish Water datalogger D3017_GISX: Specifies the X coordinate of the location of the meter D3018_GISY: Specifies the Y coordinate of the location of the meter D3019_GISZFreeDescriptor: Specifies the Z Free Descriptor of the location of the meter D3022_MeterTreatment: Meter Treatment Indicator D3023_AccreditedEntityInstall: Accredited Entity Install - Allows Scottish Water to notify the CMA when an operation has been carried out by an accredited installer D3025_MeterLocationCode: Meter Location Code <p>T004.0_NewMeter</p> |
| <p>namespace</p> | <p>urn:bridgeall-com:cmaservice:data:v3</p> |
| <p>type</p> | <p>T004.0_NewMeterType</p> |

| properties | isRef 0 content complex | | | | | | | | | | | | | | | | | | |
|----------------------------|--------------------------------------------------------------------------------------------------------------------------------------------------------------------------------------------------------------------------------------------------------------------------------------------------------------------------------------------------------------------------------------------------------------------------------------------------------------------------------------------------------------------------------------------------------------------------------------------------------------------------------------------------------------------------------------------------------------------------------------|----------|---------|-------|------------|-------|------------|---------------------|-------------------------------|----------|--|--|--|----------------------------|-------------------------------|----------|--|--|--|
| children | D2001_SPID D3001_MeterId D3004_NrDigits MeterLocation D3003_PhysicalMeterSize D3002_ChargeableMeterSize D3005_SewerageChargeableMeterSize D3011_MeterReadFrequency D3007_ReturnToSewerAllowance D3013_MeterMake D3014_ManufacturerMeterSerialNr D3015_datalogger_SW D3016_datalogger_NonSW D3017_GISX D3018_GISY D3019_GISZFreeDescriptor D3022_MeterTreatment D3023_AccreditedEntityInstall D3025_MeterLocationCode | | | | | | | | | | | | | | | | | | |
| attributes | <table border="1"> <thead> <tr> <th>Name</th> <th>Type</th> <th>Use</th> <th>Default</th> <th>Fixed</th> <th>annotation</th> </tr> </thead> <tbody> <tr> <td>MID</td> <td>MessageIdType</td> <td>required</td> <td></td> <td></td> <td></td> </tr> <tr> <td>RelatedMID</td> <td>MessageIdType</td> <td>optional</td> <td></td> <td></td> <td></td> </tr> </tbody> </table> | Name | Type | Use | Default | Fixed | annotation | MID | MessageIdType | required | | | | RelatedMID | MessageIdType | optional | | | |
| Name | Type | Use | Default | Fixed | annotation | | | | | | | | | | | | | | |
| MID | MessageIdType | required | | | | | | | | | | | | | | | | | |
| RelatedMID | MessageIdType | optional | | | | | | | | | | | | | | | | | |
| source | <code><xs:element name="T004.0_NewMeter" type="T004.0_NewMeterType"/></code> | | | | | | | | | | | | | | | | | | |

element **MessagesType/T004.2_LPMeterUpdates**

| | |
|------------|-------------------------------------------------------------------------------------------------------------------------------------------------------------------------------------------------------------------------------------------------------------------------------------------------|
| diagram | |
| namespace | urn:bridgeall-com:cmaservice:data:v3 |
| properties | isRef 0 content complex |
| children | T004.2_LPMeterUpdate |
| source | <code><xs:element name="T004.2_LPMeterUpdates"> <xs:complexType> <xs:sequence maxOccurs="unbounded"> <xs:element name="T004.2_LPMeterUpdate" type="LPMeterUpdateType"/> </xs:sequence> </xs:complexType> </xs:element></code> |

element **MessagesType/T004.2_LPMeterUpdates/T004.2_LPMeterUpdate**

| | |
|-----------|--------------------------------------|
| diagram | |
| namespace | urn:bridgeall-com:cmaservice:data:v3 |

| | | | | | | |
|------------|---------------------------------------------------------------------------------------|-------------------------------|----------|---------|-------|------------|
| type | LPMeterUpdateType | | | | | |
| properties | isRef | 0 | content | complex | | |
| children | D2001 SPID D3001 MeterId D2010 YVe | | | | | |
| attributes | Name | Type | Use | Default | Fixed | annotation |
| | MID | MessageIdType | required | | | |
| | RelatedMID | MessageIdType | optional | | | |
| source | <code><xs:element name="T004.2_LPMeterUpdate" type="LPMeterUpdateType"/></code> | | | | | |

element **MessagesType/T004.3_VirtualMeters**

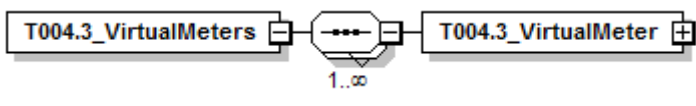
| | |
|------------|-----------------------------------------------------------------------------------------------------------------------------------------------------------------------------------------------------------------------------------------------------------------------------------------------------------------------|
| diagram |  |
| namespace | urn:bridgeall-com:cmaservice:data:v3 |
| properties | isRef 0 content complex |
| children | T004.3_VirtualMeter |
| source | <code><xs:element name="T004.3_VirtualMeters"> <xs:complexType> <xs:sequence maxOccurs="unbounded"> <xs:element name="T004.3_VirtualMeter" type="T004.3_VirtualMeterType"/> </xs:sequence> </xs:complexType> </xs:element></code> |

element **MessagesType/T004.3_VirtualMeters/T004.3_VirtualMeter**

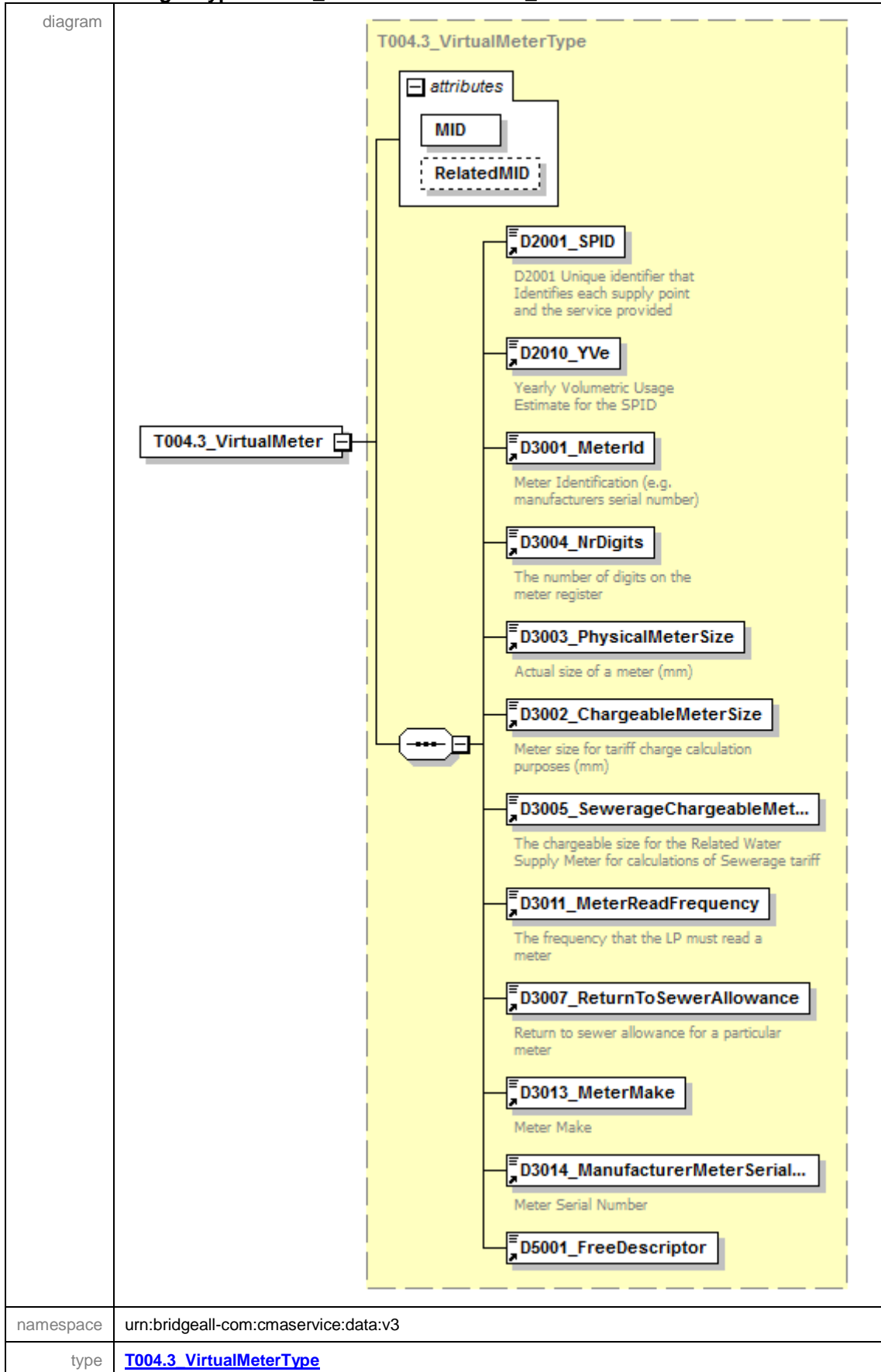

| properties | isRef 0 content complex | | | | | | | | | | | | | | | | | | |
|----------------------------|------------------------------------------------------------------------------------------------------------------------------------------------------------------------------------------------------------------------------------------------------------------------------------------------------------------------------------------------------------------------------------------------------------------------------------------------------------------|----------|---------|-------|------------|-------|------------|---------------------|-------------------------------|----------|--|--|--|----------------------------|-------------------------------|----------|--|--|--|
| children | D2001_SPID D2010_YVe D3001_MeterId D3004_NrDigits D3003_PhysicalMeterSize D3002_ChargeableMeterSize D3005_SewerageChargeableMeterSize D3011_MeterReadFrequency D3007_ReturnToSewerAllowance D3013_MeterMake D3014_ManufacturerMeterSerialNr D5001_FreeDescriptor | | | | | | | | | | | | | | | | | | |
| attributes | <table border="1"> <thead> <tr> <th>Name</th> <th>Type</th> <th>Use</th> <th>Default</th> <th>Fixed</th> <th>annotation</th> </tr> </thead> <tbody> <tr> <td>MID</td> <td>MessageIdType</td> <td>required</td> <td></td> <td></td> <td></td> </tr> <tr> <td>RelatedMID</td> <td>MessageIdType</td> <td>optional</td> <td></td> <td></td> <td></td> </tr> </tbody> </table> | Name | Type | Use | Default | Fixed | annotation | MID | MessageIdType | required | | | | RelatedMID | MessageIdType | optional | | | |
| Name | Type | Use | Default | Fixed | annotation | | | | | | | | | | | | | | |
| MID | MessageIdType | required | | | | | | | | | | | | | | | | | |
| RelatedMID | MessageIdType | optional | | | | | | | | | | | | | | | | | |
| source | <code><xs:element name="T004.3_VirtualMeter" type="T004.3_VirtualMeterType"/></code> | | | | | | | | | | | | | | | | | | |

element **MessagesType/T005.0_SWMeterReads**

| | |
|------------|---------------------------------------------------------------------------------------------------------------------------------------------------------------------------------------------------------------------------------------------------------------------------------|
| diagram |  |
| namespace | urn:bridgeall-com:cmaservice:data:v3 |
| properties | isRef 0 content complex |
| children | T005.0_SWMeterRead |
| source | <pre><xs:element name="T005.0_SWMeterReads"> <xs:complexType> <xs:sequence maxOccurs="unbounded"> <xs:element name="T005.0_SWMeterRead" type="MeterReadType"/> </xs:sequence> </xs:complexType> </xs:element></pre> |

element **MessagesType/T005.0_SWMeterReads/T005.0_SWMeterRead**

| <p>diagram</p> | | | | | | | | | | | | | | | | | | | |
|----------------------------|--------------------------------------------------------------------------------------------------------------------------------------------------------------------------------------------------------------------------------------------------------------------------------------------------------------------------------------------------------------------------------------------------------------------------------------------|----------|---------|-------|------------|-------|------------|---------------------|-------------------------------|----------|--|--|--|----------------------------|-------------------------------|----------|--|--|--|
| <p>namespace</p> | <p>urn:bridgeall-com:cmaservice:data:v3</p> | | | | | | | | | | | | | | | | | | |
| <p>type</p> | <p>MeterReadType</p> | | | | | | | | | | | | | | | | | | |
| <p>properties</p> | <p>isRef 0 content complex</p> | | | | | | | | | | | | | | | | | | |
| <p>children</p> | <p>D2001_SPID D3001_MeterId D3008_MeterRead D3009_MeterReadDate D3010_MeterReadType D3028_SReadReasonCode D3029_SReadRemedialWorkIndicator D3012_ReRead D3020_Rollover_Indicator</p> | | | | | | | | | | | | | | | | | | |
| <p>attributes</p> | <table border="1"> <thead> <tr> <th>Name</th> <th>Type</th> <th>Use</th> <th>Default</th> <th>Fixed</th> <th>annotation</th> </tr> </thead> <tbody> <tr> <td>MID</td> <td>MessageIdType</td> <td>required</td> <td></td> <td></td> <td></td> </tr> <tr> <td>RelatedMID</td> <td>MessageIdType</td> <td>optional</td> <td></td> <td></td> <td></td> </tr> </tbody> </table> | Name | Type | Use | Default | Fixed | annotation | MID | MessageIdType | required | | | | RelatedMID | MessageIdType | optional | | | |
| Name | Type | Use | Default | Fixed | annotation | | | | | | | | | | | | | | |
| MID | MessageIdType | required | | | | | | | | | | | | | | | | | |
| RelatedMID | MessageIdType | optional | | | | | | | | | | | | | | | | | |
| <p>source</p> | <p><xs:element name="T005.0_SWMeterRead" type="MeterReadType"/></p> | | | | | | | | | | | | | | | | | | |

element **MessagesType/T005.1_LPMeterReads**

| | |
|------------|-----------------------------------------------------------------------------------------------------------------------------------------------------------------------------------------------------------------------------------------------------------------------------------|
| diagram | |
| namespace | urn:bridgeall-com:cmaservice:data:v3 |
| properties | isRef 0 content complex |
| children | T005.1_LPMeterRead |
| source | <pre> <xs:element name="T005.1_LPMeterReads"> <xs:complexType> <xs:sequence maxOccurs="unbounded"> <xs:element name="T005.1_LPMeterRead" type="MeterReadType"/> </xs:sequence> </xs:complexType> </xs:element> </pre> |

element **MessagesType/T005.1_LPMeterReads/T005.1_LPMeterRead**

| <p>diagram</p> | | | | | | | | | | | | | | | | | | | |
|----------------------------|--------------------------------------------------------------------------------------------------------------------------------------------------------------------------------------------------------------------------------------------------------------------------------------------------------------------------------------------------------------------------------------------------------------------------------------------|----------|---------|-------|------------|-------|------------|---------------------|-------------------------------|----------|--|--|--|----------------------------|-------------------------------|----------|--|--|--|
| <p>namespace</p> | <p>urn:bridgeall-com:cmaservice:data:v3</p> | | | | | | | | | | | | | | | | | | |
| <p>type</p> | <p>MeterReadType</p> | | | | | | | | | | | | | | | | | | |
| <p>properties</p> | <p>isRef 0 content complex</p> | | | | | | | | | | | | | | | | | | |
| <p>children</p> | <p>D2001_SPID D3001_MeterId D3008_MeterRead D3009_MeterReadDate D3010_MeterReadType D3028_SReadReasonCode D3029_SReadRemedialWorkIndicator D3012_ReRead D3020_Rollover_Indicator</p> | | | | | | | | | | | | | | | | | | |
| <p>attributes</p> | <table border="1"> <thead> <tr> <th>Name</th> <th>Type</th> <th>Use</th> <th>Default</th> <th>Fixed</th> <th>annotation</th> </tr> </thead> <tbody> <tr> <td>MID</td> <td>MessageIdType</td> <td>required</td> <td></td> <td></td> <td></td> </tr> <tr> <td>RelatedMID</td> <td>MessageIdType</td> <td>optional</td> <td></td> <td></td> <td></td> </tr> </tbody> </table> | Name | Type | Use | Default | Fixed | annotation | MID | MessageIdType | required | | | | RelatedMID | MessageIdType | optional | | | |
| Name | Type | Use | Default | Fixed | annotation | | | | | | | | | | | | | | |
| MID | MessageIdType | required | | | | | | | | | | | | | | | | | |
| RelatedMID | MessageIdType | optional | | | | | | | | | | | | | | | | | |
| <p>source</p> | <p><xs:element name="T005.1_LPMeterRead" type="MeterReadType"/></p> | | | | | | | | | | | | | | | | | | |

element **MessagesType/T006.0_LPWaterSPIDUpdates**

| | |
|------------|------------------------------------------------------------------------------------------------------------------------------------------------------------------------------------------------------------------------------------------------------------------------------------------------------------|
| diagram |  |
| namespace | urn:bridgeall-com:cmaservice:data:v3 |
| properties | isRef 0 content complex |
| children | T006.0_LPWaterSPIDUpdate |
| source | <pre><xs:element name="T006.0_LPWaterSPIDUpdates"> <xs:complexType> <xs:sequence maxOccurs="unbounded"> <xs:element name="T006.0_LPWaterSPIDUpdate" type="T006.0_LPWaterSPIDUpdateType"/> </xs:sequence> </xs:complexType> </xs:element></pre> |

element **MessagesType/T006.0_LPWaterSPIDUpdates/T006.0_LPWaterSPIDUpdate**

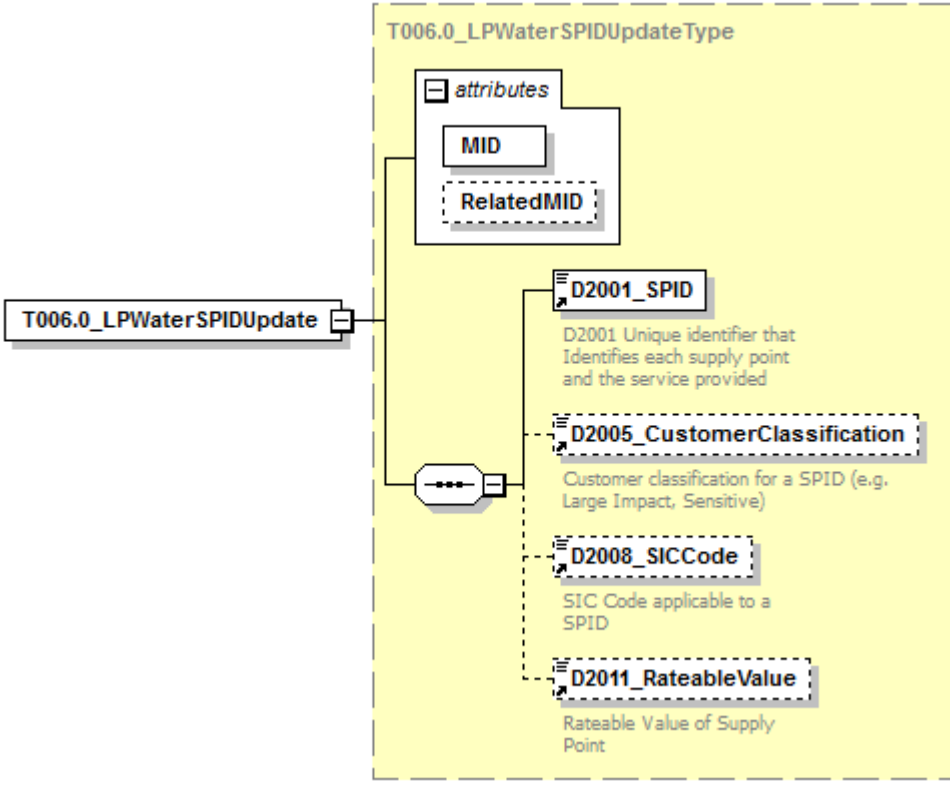
| diagram |  | | | | | | | | | | | | |
|---------------------|------------------------------------------------------------------------------------------------------------------------------------------------------------------------------------------------------------------------------------------------------------------------------------------------------|----------|---------|-------|------------|-------|------------|---------------------|-------------------------------|----------|--|--|--|
| namespace | urn:bridgeall-com:cmaservice:data:v3 | | | | | | | | | | | | |
| type | T006.0_LPWaterSPIDUpdateType | | | | | | | | | | | | |
| properties | isRef 0 content complex | | | | | | | | | | | | |
| children | D2001_SPID D2005_CustomerClassification D2008_SICCode D2011_RateableValue | | | | | | | | | | | | |
| attributes | <table border="1"> <thead> <tr> <th>Name</th> <th>Type</th> <th>Use</th> <th>Default</th> <th>Fixed</th> <th>annotation</th> </tr> </thead> <tbody> <tr> <td>MID</td> <td>MessageIdType</td> <td>required</td> <td></td> <td></td> <td></td> </tr> </tbody> </table> | Name | Type | Use | Default | Fixed | annotation | MID | MessageIdType | required | | | |
| Name | Type | Use | Default | Fixed | annotation | | | | | | | | |
| MID | MessageIdType | required | | | | | | | | | | | |

| | |
|--------|------------------------------------------------------------------------------------------------------|
| | RelatedMID MessageIdType optional |
| source | <code><xs:element name="T006.0_LPWaterSPIDUpdate" type="T006.0_LPWaterSPIDUpdateType"/></code> |

element **MessagesType/T006.1_LPSewerageSPIDUpdates**

| | |
|------------|--------------------------------------------------------------------------------------------------------------------------------------------------------------------------------------------------------------------------------------------------------------------------------------------------------------------------------------|
| diagram | |
| namespace | urn:bridgeall-com:cmaservice:data:v3 |
| properties | isRef 0 content complex |
| children | T006.1_LP_Sewerage_SPID_Update |
| source | <code><xs:element name="T006.1_LP_Sewerage_SPID_Updates"> <xs:complexType> <xs:sequence maxOccurs="unbounded"> <xs:element name="T006.1_LP_Sewerage_SPID_Update" type="T006.1_LP_Sewerage_SPID_UpdateType"/> </xs:sequence> </xs:complexType> </xs:element></code> |

element **MessagesType/T006.1_LPSewerageSPIDUpdates/T006.1_LP_Sewerage_SPID_Update**

| | |
|-----------|--------------------------------------|
| diagram | |
| namespace | urn:bridgeall-com:cmaservice:data:v3 |

| | | | | | | |
|------------|-------------------------------------------------------------------------------------------------------------------------------------------|-------------------------------|----------|---------|-------|------------|
| type | T006.1_LPSewerageSPIDUpdateType | | | | | |
| properties | isRef | 0 | content | complex | | |
| children | D2001_SPID D2005_CustomerClassification D2008_SICCode D2011_RateableValue | | | | | |
| attributes | Name | Type | Use | Default | Fixed | annotation |
| | MID | MessageIdType | required | | | |
| | RelatedMID | MessageIdType | optional | | | |
| source | <code><xs:element name="T006.1_LPSewerageSPIDUpdate" type="T006.1_LPSewerageSPIDUpdateType"/></code> | | | | | |

element **MessagesType/T006.2_WaterSPIDUpdates**

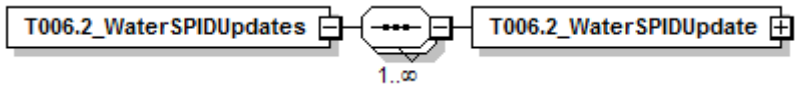
| | |
|------------|--------------------------------------------------------------------------------------------------------------------------------------------------------------------------------------------------------------------------------------------------------------------------------------------------------------------------------|
| diagram |  |
| namespace | urn:bridgeall-com:cmaservice:data:v3 |
| properties | isRef 0 content complex |
| children | T006.2_WaterSPIDUpdate |
| source | <code><xs:element name="T006.2_WaterSPIDUpdates"> <xs:complexType> <xs:sequence maxOccurs="unbounded"> <xs:element name="T006.2_WaterSPIDUpdate" type="T006.2_WaterSPIDUpdateType"/> </xs:sequence> </xs:complexType> </xs:element></code> |

element **MessagesType/T006.2_WaterSPIDUpdates/T006.2_WaterSPIDUpdate**

| diagram | | | | | | | | | | | | | | | | | | | |
|----------------------------|--------------------------------------------------------------------------------------------------------------------------------------------------------------------------------------------------------------------------------------------------------------------------------------------------------------------------------------------------------------------------------------------------------------------------------------------|----------|---------|-------|------------|-------|------------|---------------------|-------------------------------|----------|--|--|--|----------------------------|-------------------------------|----------|--|--|--|
| namespace | urn:bridgeall-com:cmaservice:data:v3 | | | | | | | | | | | | | | | | | | |
| type | T006.2_WaterSPIDUpdateType | | | | | | | | | | | | | | | | | | |
| properties | isRef 0 content complex | | | | | | | | | | | | | | | | | | |
| children | D2001_SPID D2018_TroughsDrinkingBowls D2020_OutsideTaps D2014_FarmCroft | | | | | | | | | | | | | | | | | | |
| attributes | <table border="1"> <thead> <tr> <th>Name</th> <th>Type</th> <th>Use</th> <th>Default</th> <th>Fixed</th> <th>annotation</th> </tr> </thead> <tbody> <tr> <td>MID</td> <td>MessageIdType</td> <td>required</td> <td></td> <td></td> <td></td> </tr> <tr> <td>RelatedMID</td> <td>MessageIdType</td> <td>optional</td> <td></td> <td></td> <td></td> </tr> </tbody> </table> | Name | Type | Use | Default | Fixed | annotation | MID | MessageIdType | required | | | | RelatedMID | MessageIdType | optional | | | |
| Name | Type | Use | Default | Fixed | annotation | | | | | | | | | | | | | | |
| MID | MessageIdType | required | | | | | | | | | | | | | | | | | |
| RelatedMID | MessageIdType | optional | | | | | | | | | | | | | | | | | |
| source | <pre><xs:element name="T006.2_WaterSPIDUpdate" type="T006.2_WaterSPIDUpdateType"/></pre> | | | | | | | | | | | | | | | | | | |

element **MessagesType/T006.3_SewerageSPIDUpdates**

| | |
|------------|---------------------------------------------------------------------------------------------------------------------------------------------------------------------------------------------------------------------------------------------------------------------------------------------------------------|
| diagram | |
| namespace | urn:bridgeall-com:cmaservice:data:v3 |
| properties | isRef 0 content complex |
| children | T006.3_SewerageSPIDUpdate |
| source | <pre><xs:element name="T006.3_SewerageSPIDUpdates"> <xs:complexType> <xs:sequence maxOccurs="unbounded"> <xs:element name="T006.3_SewerageSPIDUpdate" type="T006.3_SewerageSPIDUpdateType"/> </xs:sequence> </xs:complexType> </xs:element></pre> |

| | |
|--|-------------------------------------------------------------------------------|
| | <pre> </xs:sequence> </xs:complexType> </xs:element> </pre> |
|--|-------------------------------------------------------------------------------|

element **MessagesType/T006.3_SewerageSPIDUpdates/T006.3_SewerageSPIDUpdate**

| diagram | | | | | | | | | | | | | | | | | | | |
|----------------------------|--------------------------------------------------------------------------------------------------------------------------------------------------------------------------------------------------------------------------------------------------------------------------------------------------------------------------------------------------------------------------------------------------------------------------------------------|----------|---------|-------|------------|-------|------------|---------------------|-------------------------------|----------|--|--|--|----------------------------|-------------------------------|----------|--|--|--|
| namespace | urn:bridgeall-com:cmaservice:data:v3 | | | | | | | | | | | | | | | | | | |
| type | T006.3_SewerageSPIDUpdateType | | | | | | | | | | | | | | | | | | |
| properties | isRef 0 content complex | | | | | | | | | | | | | | | | | | |
| children | D2001_SPID D2016_PropertyDrainage D2017_RoadDrainage | | | | | | | | | | | | | | | | | | |
| attributes | <table border="1"> <thead> <tr> <th>Name</th> <th>Type</th> <th>Use</th> <th>Default</th> <th>Fixed</th> <th>annotation</th> </tr> </thead> <tbody> <tr> <td>MID</td> <td>MessageIdType</td> <td>required</td> <td></td> <td></td> <td></td> </tr> <tr> <td>RelatedMID</td> <td>MessageIdType</td> <td>optional</td> <td></td> <td></td> <td></td> </tr> </tbody> </table> | Name | Type | Use | Default | Fixed | annotation | MID | MessageIdType | required | | | | RelatedMID | MessageIdType | optional | | | |
| Name | Type | Use | Default | Fixed | annotation | | | | | | | | | | | | | | |
| MID | MessageIdType | required | | | | | | | | | | | | | | | | | |
| RelatedMID | MessageIdType | optional | | | | | | | | | | | | | | | | | |
| source | <pre> <xs:element name="T006.3_SewerageSPIDUpdate" type="T006.3_SewerageSPIDUpdateType"/> </pre> | | | | | | | | | | | | | | | | | | |

element **MessagesType/T006.6_ProvideLiveRateableValues**

| | |
|------------|------------------------------------------------------------------------------------------------------------------------------------------------------------------------------------------------------------------------------------------------|
| diagram | |
| namespace | urn:bridgeall-com:cmaservice:data:v3 |
| properties | isRef 0 content complex |
| children | T006.6_ProvideLiveRateableValue |
| source | <pre> <xs:element name="T006.6_ProvideLiveRateableValues"> <xs:complexType> <xs:sequence maxOccurs="unbounded"> <xs:element name="T006.6_ProvideLiveRateableValue" type="T006.6_ProvideLiveRateableValueType"/> </pre> |

```

</xs:sequence>
</xs:complexType>
</xs:element>

```

element

MessageType/T006.6_ProvideLiveRateableValues/T006.6_ProvideLiveRateableValue

| | | | | | | |
|------------|--------------------------------------------------------------------------------------------------------------------|-------------------------------|----------|---------|-------|------------|
| diagram | | | | | | |
| namespace | urn:bridgeall-com:cmaservice:data:v3 | | | | | |
| type | T006.6_ProvideLiveRateableValueType | | | | | |
| properties | isRef | 0 | | | | |
| | content | complex | | | | |
| children | D2001_SPID D2042_LiveRateableValue | | | | | |
| attributes | Name | Type | Use | Default | Fixed | annotation |
| | MID | MessageIdType | required | | | |
| | RelatedMID | MessageIdType | optional | | | |
| source | <pre> <xs:element name="T006.6_ProvideLiveRateableValue" type="T006.6_ProvideLiveRateableValueType"/> </pre> | | | | | |

element **MessageType/T007.0_WaterConnectionCompletes**

| | | | | | | |
|------------|------------------------------------------------------------------------------------------------------------------------------------------------------------------------------------------------------------------------------------------------------------------------------------------|---------|--|--|--|--|
| diagram | | | | | | |
| namespace | urn:bridgeall-com:cmaservice:data:v3 | | | | | |
| properties | isRef | 0 | | | | |
| | content | complex | | | | |
| children | T007.0_WaterConnectionComplete | | | | | |
| source | <pre> <xs:element name="T007.0_WaterConnectionCompletes"> <xs:complexType> <xs:sequence maxOccurs="unbounded"> <xs:element name="T007.0_WaterConnectionComplete" type="T007.0_WaterConnectionCompleteType"/> </xs:sequence> </xs:complexType> </pre> | | | | | |

</xs:element>

element

MessagesType/T007.0_WaterConnectionCompletes/T007.0_WaterConnectionComplete

| diagram | <p>The diagram shows a yellow box representing the T007.0_WaterConnectionCompleteType. On the left, a box labeled T007.0_WaterConnectionCompl... is connected to a central connector. This connector branches into three paths: <ul style="list-style-type: none"> An attributes container containing MID (a solid box) and RelatedMID (a dashed box). A child element D2001_SPID with the description: "D2001 Unique identifier that Identifies each supply point and the service provided". A child element D2013_ConnectionDate with the description: "Date the connection was completed". A child element D2033_AccreditedEntityInstall (dashed box) with the description: "Accredited Entity Install - Allows Scottish Water to notify the CMA when an operation has been carried out by an accredited installer". </p> | | | | | | | | | | | | | | | | | | |
|----------------------------|----------------------------------------------------------------------------------------------------------------------------------------------------------------------------------------------------------------------------------------------------------------------------------------------------------------------------------------------------------------------------------------------------------------------------------------------------------------------------------------------------------------------------------------------------------------------------------------------------------------------------------------------------------------------------------------------------------------------------------------------------------------------------------------------------------------------------------------------------------------------------------------------------------------------------------------|----------|---------|-------|------------|-------|------------|---------------------|-------------------------------|----------|--|--|--|----------------------------|-------------------------------|----------|--|--|--|
| namespace | urn:bridgeall-com:cmaservice:data:v3 | | | | | | | | | | | | | | | | | | |
| type | T007.0_WaterConnectionCompleteType | | | | | | | | | | | | | | | | | | |
| properties | isRef 0 content complex | | | | | | | | | | | | | | | | | | |
| children | D2001_SPID D2013_ConnectionDate D2033_AccreditedEntityInstall | | | | | | | | | | | | | | | | | | |
| attributes | <table border="1"> <thead> <tr> <th>Name</th> <th>Type</th> <th>Use</th> <th>Default</th> <th>Fixed</th> <th>annotation</th> </tr> </thead> <tbody> <tr> <td>MID</td> <td>MessageIdType</td> <td>required</td> <td></td> <td></td> <td></td> </tr> <tr> <td>RelatedMID</td> <td>MessageIdType</td> <td>optional</td> <td></td> <td></td> <td></td> </tr> </tbody> </table> | Name | Type | Use | Default | Fixed | annotation | MID | MessageIdType | required | | | | RelatedMID | MessageIdType | optional | | | |
| Name | Type | Use | Default | Fixed | annotation | | | | | | | | | | | | | | |
| MID | MessageIdType | required | | | | | | | | | | | | | | | | | |
| RelatedMID | MessageIdType | optional | | | | | | | | | | | | | | | | | |
| source | <xs:element name="T007.0_WaterConnectionComplete" type="T007.0_WaterConnectionCompleteType"/> | | | | | | | | | | | | | | | | | | |

element MessagesType/T007.1_SewerageConnectionCompletes

| | |
|------------|------------------------------------------------------------------------------------------------------------------------------------------------------------------------------------|
| diagram | <p>The diagram shows a sequence of two boxes labeled T007.1_SewerageConnectionC... connected by a line. Below the line is a connector with the cardinality 1..∞.</p> |
| namespace | urn:bridgeall-com:cmaservice:data:v3 |
| properties | isRef 0 content complex |
| children | T007.1_SewerageConnectionComplete |
| source | <xs:element name="T007.1_SewerageConnectionCompletes"> <xs:complexType> <xs:sequence maxOccurs="unbounded"> |

| | |
|--|--------------------------------------------------------------------------------------------------------------------------------------------------------------------------|
| | <pre> <xs:element name="T007.1_SewerageConnectionComplete" type="ConnectionCompleteType"/> </xs:sequence> </xs:complexType> </xs:element> </pre> |
|--|--------------------------------------------------------------------------------------------------------------------------------------------------------------------------|

element
**MessagesType/T007.1_SewerageConnectionCompletes/T007.1_SewerageConnectionC
complete**

| diagram | | | | | | | | | | | | | | | | | | | |
|----------------------------|--------------------------------------------------------------------------------------------------------------------------------------------------------------------------------------------------------------------------------------------------------------------------------------------------------------------------------------------------------------------------------------------------------------------------------------------|----------|---------|-------|------------|-------|------------|---------------------|-------------------------------|----------|--|--|--|----------------------------|-------------------------------|----------|--|--|--|
| namespace | urn:bridgeall-com:cmaservice:data:v3 | | | | | | | | | | | | | | | | | | |
| type | ConnectionCompleteType | | | | | | | | | | | | | | | | | | |
| properties | isRef 0 content complex | | | | | | | | | | | | | | | | | | |
| children | D2001_SPID D2013_ConnectionDate | | | | | | | | | | | | | | | | | | |
| attributes | <table border="1"> <thead> <tr> <th>Name</th> <th>Type</th> <th>Use</th> <th>Default</th> <th>Fixed</th> <th>annotation</th> </tr> </thead> <tbody> <tr> <td>MID</td> <td>MessageIdType</td> <td>required</td> <td></td> <td></td> <td></td> </tr> <tr> <td>RelatedMID</td> <td>MessageIdType</td> <td>optional</td> <td></td> <td></td> <td></td> </tr> </tbody> </table> | Name | Type | Use | Default | Fixed | annotation | MID | MessageIdType | required | | | | RelatedMID | MessageIdType | optional | | | |
| Name | Type | Use | Default | Fixed | annotation | | | | | | | | | | | | | | |
| MID | MessageIdType | required | | | | | | | | | | | | | | | | | |
| RelatedMID | MessageIdType | optional | | | | | | | | | | | | | | | | | |
| source | <pre> <xs:element name="T007.1_SewerageConnectionComplete" type="ConnectionCompleteType"/> </pre> | | | | | | | | | | | | | | | | | | |

element **MessagesType/T009.2_Notifications**

| | |
|------------|--------------------------------------------------------------------------------------------------------------------------------------------------------------------------------------------------------------------------|
| diagram | |
| namespace | urn:bridgeall-com:cmaservice:data:v3 |
| properties | isRef 0 content complex |
| children | T009.2_Notification |
| source | <pre> <xs:element name="T009.2_Notifications"> <xs:complexType> <xs:sequence maxOccurs="unbounded"> <xs:element name="T009.2_Notification" type="NotificationType"/> </xs:sequence> </pre> |

| | |
|--|--------------------------------------------------------|
| | <pre></xs:complexType> </xs:element></pre> |
|--|--------------------------------------------------------|

element **MessagesType/T009.2 Notifications/T009.2 Notification**

| diagram | | | | | | | | | | | | | | | | | | | |
|----------------------------|--------------------------------------------------------------------------------------------------------------------------------------------------------------------------------------------------------------------------------------------------------------------------------------------------------------------------------------------------------------------------------------------------------------------------------------------|----------|---------|-------|------------|-------|------------|---------------------|-------------------------------|----------|--|--|--|----------------------------|-------------------------------|----------|--|--|--|
| namespace | urn:bridgeall-com:cmaservice:data:v3 | | | | | | | | | | | | | | | | | | |
| type | NotificationType | | | | | | | | | | | | | | | | | | |
| properties | isRef 0 content complex | | | | | | | | | | | | | | | | | | |
| children | D1008_DataItemRef D4004_ReturnCode D2001_SPID | | | | | | | | | | | | | | | | | | |
| attributes | <table border="1"> <thead> <tr> <th>Name</th> <th>Type</th> <th>Use</th> <th>Default</th> <th>Fixed</th> <th>annotation</th> </tr> </thead> <tbody> <tr> <td>MID</td> <td>MessageIdType</td> <td>required</td> <td></td> <td></td> <td></td> </tr> <tr> <td>RelatedMID</td> <td>MessageIdType</td> <td>optional</td> <td></td> <td></td> <td></td> </tr> </tbody> </table> | Name | Type | Use | Default | Fixed | annotation | MID | MessageIdType | required | | | | RelatedMID | MessageIdType | optional | | | |
| Name | Type | Use | Default | Fixed | annotation | | | | | | | | | | | | | | |
| MID | MessageIdType | required | | | | | | | | | | | | | | | | | |
| RelatedMID | MessageIdType | optional | | | | | | | | | | | | | | | | | |
| source | <pre><xs:element name="T009.2_Notification" type="NotificationType"/></pre> | | | | | | | | | | | | | | | | | | |

element **MessagesType/T009.3 Notifications**

| | |
|------------|--------------------------------------------------------------------------------------------------------------------------------------------------------------------------------------------------------------------------------------------------------------------------------------|
| diagram | |
| namespace | urn:bridgeall-com:cmaservice:data:v3 |
| properties | isRef 0 content complex |
| children | T009.3_Notification |
| source | <pre><xs:element name="T009.3_Notifications"> <xs:complexType> <xs:sequence maxOccurs="unbounded"> <xs:element name="T009.3_Notification" type="NotificationType"/> </xs:sequence> </xs:complexType> </xs:element></pre> |

element **MessagesType/T009.3_Notifications/T009.3_Notification**

| diagram | | | | | | | | | | | | | | | | | | | |
|----------------------------|--------------------------------------------------------------------------------------------------------------------------------------------------------------------------------------------------------------------------------------------------------------------------------------------------------------------------------------------------------------------------------------------------------------------------------------------|----------|---------|-------|------------|-------|------------|---------------------|-------------------------------|----------|--|--|--|----------------------------|-------------------------------|----------|--|--|--|
| namespace | urn:bridgeall-com:cmaservice:data:v3 | | | | | | | | | | | | | | | | | | |
| type | NotificationType | | | | | | | | | | | | | | | | | | |
| properties | isRef 0 content complex | | | | | | | | | | | | | | | | | | |
| children | D1008_DataItemRef D4004_ReturnCode D2001_SPID | | | | | | | | | | | | | | | | | | |
| attributes | <table border="1"> <thead> <tr> <th>Name</th> <th>Type</th> <th>Use</th> <th>Default</th> <th>Fixed</th> <th>annotation</th> </tr> </thead> <tbody> <tr> <td>MID</td> <td>MessageIdType</td> <td>required</td> <td></td> <td></td> <td></td> </tr> <tr> <td>RelatedMID</td> <td>MessageIdType</td> <td>optional</td> <td></td> <td></td> <td></td> </tr> </tbody> </table> | Name | Type | Use | Default | Fixed | annotation | MID | MessageIdType | required | | | | RelatedMID | MessageIdType | optional | | | |
| Name | Type | Use | Default | Fixed | annotation | | | | | | | | | | | | | | |
| MID | MessageIdType | required | | | | | | | | | | | | | | | | | |
| RelatedMID | MessageIdType | optional | | | | | | | | | | | | | | | | | |
| source | <code><xs:element name="T009.3_Notification" type="NotificationType"/></code> | | | | | | | | | | | | | | | | | | |

element **MessagesType/T010.0_CancelRegistrationIncomings**

| | |
|------------|--------------------------------------------------------------------------------------------------------------------------------------------------------------------------------------------------------------------------------------------------------------------------------------------------------------------------|
| diagram | |
| namespace | urn:bridgeall-com:cmaservice:data:v3 |
| properties | isRef 0 content complex |
| children | T010.0_CancelRegistrationIncoming |
| source | <pre> <xs:element name="T010.0_CancelRegistrationIncomings"> <xs:complexType> <xs:sequence maxOccurs="unbounded"> <xs:element name="T010.0_CancelRegistrationIncoming" type="CancelRegistrationType"/> </xs:sequence> </xs:complexType> </xs:element> </pre> |

element

**MessagesType/T010.0_CancelRegistrationIncomings/T010.0_CancelRegistrationIncomi
ng**

| | | | | | | |
|------------|-------------------------------------------------------------------------------------------------------|-------------------------------|----------|---------|-------|------------|
| diagram | | | | | | |
| namespace | urn:bridgeall-com:cmaservice:data:v3 | | | | | |
| type | CancelRegistrationType | | | | | |
| properties | isRef | 0 | content | complex | | |
| children | D2001_SPID D4005_CancellationCode | | | | | |
| attributes | Name | Type | Use | Default | Fixed | annotation |
| | MID | MessageIdType | required | | | |
| | RelatedMID | MessageIdType | optional | | | |
| source | <pre><xs:element name="T010.0_CancelRegistrationIncoming" type="CancelRegistrationType"/></pre> | | | | | |

element MessagesType/T010.1_CancelRegistrationOutgoings

| | | | | | | |
|------------|---------------------------------------------------------------------------------------------------------------------------------------------------------------------------------------------------------------------------------------------------------------------------------------------------------------------------|---|---------|---------|--|--|
| diagram | | | | | | |
| namespace | urn:bridgeall-com:cmaservice:data:v3 | | | | | |
| properties | isRef | 0 | content | complex | | |
| children | T010.1_CancelRegistrationOutgoing | | | | | |
| source | <pre><xs:element name="T010.1_CancelRegistrationOutgoings"> <xs:complexType> <xs:sequence maxOccurs="unbounded"> <xs:element name="T010.1_CancelRegistrationOutgoing" type="CancelRegistrationOutType"/> </xs:sequence> </xs:complexType> </xs:element></pre> | | | | | |

element

MessageType/T010.1_CancelRegistrationOutgoings/T010.1_CancelRegistrationOutgoing

| diagram | | | | | | | | | | | | | | | | | | | |
|----------------------------|--------------------------------------------------------------------------------------------------------------------------------------------------------------------------------------------------------------------------------------------------------------------------------------------------------------------------------------------------------------------------------------------------------------------------------------------|----------|---------|-------|------------|-------|------------|---------------------|-------------------------------|----------|--|--|--|----------------------------|-------------------------------|----------|--|--|--|
| namespace | urn:bridgeall-com:cmaservice:data:v3 | | | | | | | | | | | | | | | | | | |
| type | CancelRegistrationOutType | | | | | | | | | | | | | | | | | | |
| properties | isRef 0 content complex | | | | | | | | | | | | | | | | | | |
| children | D2001_SPID D4005_CancellationCode D4003_Comment | | | | | | | | | | | | | | | | | | |
| attributes | <table border="1"> <thead> <tr> <th>Name</th> <th>Type</th> <th>Use</th> <th>Default</th> <th>Fixed</th> <th>annotation</th> </tr> </thead> <tbody> <tr> <td>MID</td> <td>MessageIdType</td> <td>required</td> <td></td> <td></td> <td></td> </tr> <tr> <td>RelatedMID</td> <td>MessageIdType</td> <td>optional</td> <td></td> <td></td> <td></td> </tr> </tbody> </table> | Name | Type | Use | Default | Fixed | annotation | MID | MessageIdType | required | | | | RelatedMID | MessageIdType | optional | | | |
| Name | Type | Use | Default | Fixed | annotation | | | | | | | | | | | | | | |
| MID | MessageIdType | required | | | | | | | | | | | | | | | | | |
| RelatedMID | MessageIdType | optional | | | | | | | | | | | | | | | | | |
| source | <xs:element name="T010.1_CancelRegistrationOutgoing" type="CancelRegistrationOutType"/> | | | | | | | | | | | | | | | | | | |

element MessageType/T012.0_MiscSPIDUpdates

| | |
|------------|---------------------------------------------------------------------------------------------------------------------------------------------------------------------------------------------------------------------------------------------------------------------------------------------------|
| diagram | |
| namespace | urn:bridgeall-com:cmaservice:data:v3 |
| properties | isRef 0 content complex |
| children | T012.0_MiscSPIDUpdate |
| source | <pre><xs:element name="T012.0_MiscSPIDUpdates"> <xs:complexType> <xs:sequence maxOccurs="unbounded"> <xs:element name="T012.0_MiscSPIDUpdate" type="T012.0_MiscSPIDUpdateType"/> </xs:sequence> </xs:complexType> </xs:element></pre> |

element **MessagesType/T012.0_MiscSPIDUpdates/T012.0_MiscSPIDUpdate**

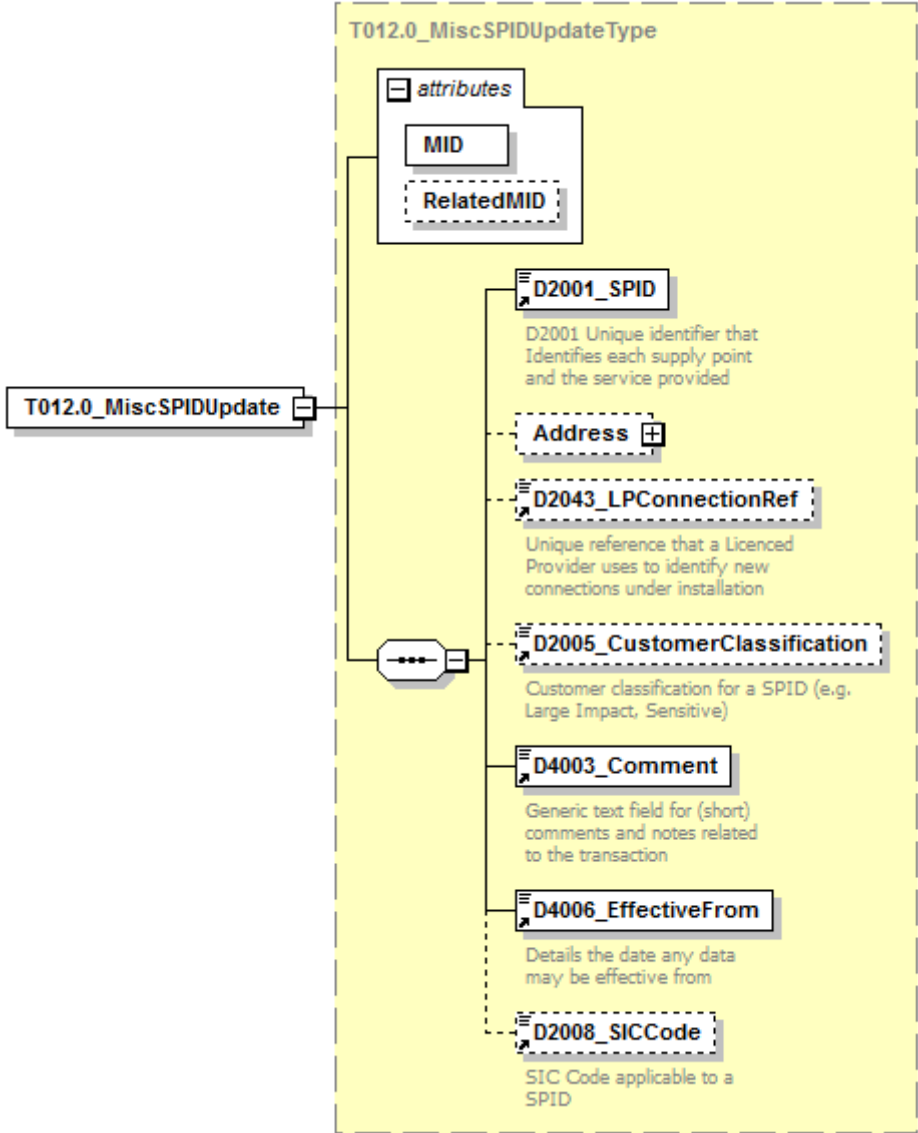
| <p>diagram</p> |  | | | | | | | | | | | | | | | | | | |
|----------------------------|--------------------------------------------------------------------------------------------------------------------------------------------------------------------------------------------------------------------------------------------------------------------------------------------------------------------------------------------------------------------------------------------------------------------------------------------|----------|---------|-------|------------|-------|------------|---------------------|-------------------------------|----------|--|--|--|----------------------------|-------------------------------|----------|--|--|--|
| <p>namespace</p> | <p>urn:bridgeall-com:cmaservice:data:v3</p> | | | | | | | | | | | | | | | | | | |
| <p>type</p> | <p>T012.0_MiscSPIDUpdateType</p> | | | | | | | | | | | | | | | | | | |
| <p>properties</p> | <p>isRef 0 content complex</p> | | | | | | | | | | | | | | | | | | |
| <p>children</p> | <p>D2001_SPID Address D2043_LPConnectionRef D2005_CustomerClassification D4003_Comment D4006_EffectiveFrom D2008_SICCode</p> | | | | | | | | | | | | | | | | | | |
| <p>attributes</p> | <table border="1"> <thead> <tr> <th>Name</th> <th>Type</th> <th>Use</th> <th>Default</th> <th>Fixed</th> <th>annotation</th> </tr> </thead> <tbody> <tr> <td>MID</td> <td>MessageIdType</td> <td>required</td> <td></td> <td></td> <td></td> </tr> <tr> <td>RelatedMID</td> <td>MessageIdType</td> <td>optional</td> <td></td> <td></td> <td></td> </tr> </tbody> </table> | Name | Type | Use | Default | Fixed | annotation | MID | MessageIdType | required | | | | RelatedMID | MessageIdType | optional | | | |
| Name | Type | Use | Default | Fixed | annotation | | | | | | | | | | | | | | |
| MID | MessageIdType | required | | | | | | | | | | | | | | | | | |
| RelatedMID | MessageIdType | optional | | | | | | | | | | | | | | | | | |
| <p>source</p> | <pre><xs:element name="T012.0_MiscSPIDUpdate" type="T012.0_MiscSPIDUpdateType"/></pre> | | | | | | | | | | | | | | | | | | |

element **MessagesType/T012.1_ServiceElementUpdates**

| | |
|------------|-----------------------------------------------------------------------------------------------------------------------------------------------------------------------------------------------------------------------------------------------------------------------------------------------------------------------|
| diagram | |
| namespace | urn:bridgeall-com:cmaservice:data:v3 |
| properties | isRef 0 content complex |
| children | T012.1_ServiceElementUpdate |
| source | <pre> <xs:element name="T012.1_ServiceElementUpdates"> <xs:complexType> <xs:sequence maxOccurs="unbounded"> <xs:element name="T012.1_ServiceElementUpdate" type="T012.1_ServiceElementUpdateType"/> </xs:sequence> </xs:complexType> </xs:element> </pre> |

element **MessageType/T012.1_ServiceElementUpdates/T012.1_ServiceElementUpdate**

| <p>diagram</p> | <p>T012.1_ServiceElementUpdateType</p> <ul style="list-style-type: none"> attributes <ul style="list-style-type: none"> MID (required) RelatedMID (optional) D2001_SPID (required): D2001 Unique identifier that Identifies each supply point and the service provided D2018_TroughsDrinkingBowls (optional): Does SPID have this Service Element (how many) D2020_OutsideTaps (optional): Does SPID have this Service Element (how many) D2011_RateableValue (optional): Rateable Value of Supply Point D2015_SPIDVacant (optional): Declares premises for the SPID as vacant D2014_FarmCroft (optional): If Outside Taps or Troughs and Drinking Bowls are True, this must be used to specify farm or croft. D4006_EffectiveFrom (required): Details the date any data may be effective from D4003_Comment (optional): Generic text field for (short) comments and notes related to the transaction | | | | | | | | | | | | | | | | | | |
|----------------------------|-----------------------------------------------------------------------------------------------------------------------------------------------------------------------------------------------------------------------------------------------------------------------------------------------------------------------------------------------------------------------------------------------------------------------------------------------------------------------------------------------------------------------------------------------------------------------------------------------------------------------------------------------------------------------------------------------------------------------------------------------------------------------------------------------------------------------------------------------------------------------------------------------------------------------------------------------------------------------------------------------------------------------------------------------------------------------------------------------------------|----------|---------|-------|------------|-------|------------|---------------------|-------------------------------|----------|--|--|--|----------------------------|-------------------------------|----------|--|--|--|
| <p>namespace</p> | <p>urn:bridgeall-com:cmaservice:data:v3</p> | | | | | | | | | | | | | | | | | | |
| <p>type</p> | <p>T012.1_ServiceElementUpdateType</p> | | | | | | | | | | | | | | | | | | |
| <p>properties</p> | <p>isRef 0 content complex</p> | | | | | | | | | | | | | | | | | | |
| <p>children</p> | <p>D2001_SPID D2018_TroughsDrinkingBowls D2020_OutsideTaps D2011_RateableValue D2015_SPIDVacant D2014_FarmCroft D4006_EffectiveFrom D4003_Comment</p> | | | | | | | | | | | | | | | | | | |
| <p>attributes</p> | <table border="1"> <thead> <tr> <th>Name</th> <th>Type</th> <th>Use</th> <th>Default</th> <th>Fixed</th> <th>annotation</th> </tr> </thead> <tbody> <tr> <td>MID</td> <td>MessageIdType</td> <td>required</td> <td></td> <td></td> <td></td> </tr> <tr> <td>RelatedMID</td> <td>MessageIdType</td> <td>optional</td> <td></td> <td></td> <td></td> </tr> </tbody> </table> | Name | Type | Use | Default | Fixed | annotation | MID | MessageIdType | required | | | | RelatedMID | MessageIdType | optional | | | |
| Name | Type | Use | Default | Fixed | annotation | | | | | | | | | | | | | | |
| MID | MessageIdType | required | | | | | | | | | | | | | | | | | |
| RelatedMID | MessageIdType | optional | | | | | | | | | | | | | | | | | |
| <p>source</p> | <p><xs:element name="T012.1_ServiceElementUpdate"</p> | | | | | | | | | | | | | | | | | | |

| | |
|--|----------------------------------------------------------|
| | <code>type="T012.1_ServiceElementUpdateType"/></code> |
|--|----------------------------------------------------------|

element **MessagesType/T012.3_SewerageServiceElementUpdates**

| | |
|------------|-----------------------------------------------------------------------------------------------------------------------------------------------------------------------------------------------------------------------------------------------------------------------------------------------------------------------------------------------|
| diagram | |
| namespace | urn:bridgeall-com:cmaservice:data:v3 |
| properties | isRef 0 content complex |
| children | T012.3_SewerageServiceElementUpdate |
| source | <pre> <xs:element name="T012.3_SewerageServiceElementUpdates"> <xs:complexType> <xs:sequence maxOccurs="unbounded"> <xs:element name="T012.3_SewerageServiceElementUpdate" type="T012.3_SewerageServiceElementUpdateType"/> </xs:sequence> </xs:complexType> </xs:element> </pre> |

element **MessagesType/T012.3_SewerageServiceElementUpdates/T012.3_SewerageServiceElementUpdate**

| | |
|---------|--|
| diagram | |
|---------|--|

| | | | | | | |
|------------|------------------------------------------------------------------------------------------------------------------------------------------------------------------------|-------------------------------|----------|---------|-------|------------|
| namespace | urn:bridgeall-com:cmaservice:data:v3 | | | | | |
| type | T012.3_SewerageServiceElementUpdateType | | | | | |
| properties | isRef | 0 | | | | |
| | content | complex | | | | |
| children | D2001_SPID D4006_EffectiveFrom D2016_PropertyDrainage D2017_RoadDrainage D4003_Comment | | | | | |
| attributes | Name | Type | Use | Default | Fixed | annotation |
| | MID | MessageIdType | required | | | |
| | RelatedMID | MessageIdType | optional | | | |
| source | <code><xs:element name="T012.3_SewerageServiceElementUpdate" type="T012.3_SewerageServiceElementUpdateType"/></code> | | | | | |

element **MessagesType/T012.5_UpdateSAARefereceNumberUPRNs**

| | | | | | | |
|------------|-------------------------------------------------------------------------------------------------------------------------------------------------------------------------------------------------------------------------------------------------------------------------------------------------------------------------------------|---------|--|--|--|--|
| diagram | | | | | | |
| namespace | urn:bridgeall-com:cmaservice:data:v3 | | | | | |
| properties | isRef | 0 | | | | |
| | content | complex | | | | |
| children | T012.5_UpdateSAARefereceNumberUPRNs | | | | | |
| source | <pre> <xs:element name="T012.5_UpdateSAARefereceNumberUPRNs"> <xs:complexType> <xs:sequence maxOccurs="unbounded"> <xs:element name="T012.5_UpdateSAARefereceNumberUPRN" type="UpdateSAARefereceNumberUPRNType"/> </xs:sequence> </xs:complexType> </xs:element> </pre> | | | | | |

element

MessageType/T012.5_UpdateSAARefereNumberUPRN

| diagram | | | | | | | | | | | | | | | | | | | |
|----------------------------|--------------------------------------------------------------------------------------------------------------------------------------------------------------------------------------------------------------------------------------------------------------------------------------------------------------------------------------------------------------------------------------------------------------------------------------------|----------|---------|-------|------------|-------|------------|---------------------|-------------------------------|----------|--|--|--|----------------------------|-------------------------------|----------|--|--|--|
| namespace | urn:bridgeall-com:cmaservice:data:v3 | | | | | | | | | | | | | | | | | | |
| type | UpdateSAARefereNumberUPRNType | | | | | | | | | | | | | | | | | | |
| properties | isRef 0 content complex | | | | | | | | | | | | | | | | | | |
| children | D2001_SPID UARNDData UPRNDData | | | | | | | | | | | | | | | | | | |
| attributes | <table border="1"> <thead> <tr> <th>Name</th> <th>Type</th> <th>Use</th> <th>Default</th> <th>Fixed</th> <th>annotation</th> </tr> </thead> <tbody> <tr> <td>MID</td> <td>MessageIdType</td> <td>required</td> <td></td> <td></td> <td></td> </tr> <tr> <td>RelatedMID</td> <td>MessageIdType</td> <td>optional</td> <td></td> <td></td> <td></td> </tr> </tbody> </table> | Name | Type | Use | Default | Fixed | annotation | MID | MessageIdType | required | | | | RelatedMID | MessageIdType | optional | | | |
| Name | Type | Use | Default | Fixed | annotation | | | | | | | | | | | | | | |
| MID | MessageIdType | required | | | | | | | | | | | | | | | | | |
| RelatedMID | MessageIdType | optional | | | | | | | | | | | | | | | | | |
| source | <code><xs:element name="T012.5_UpdateSAARefereNumberUPRN" type="UpdateSAARefereNumberUPRNType"/></code> | | | | | | | | | | | | | | | | | | |

element MessageType/T012.7_UpdateLiveRateableValues

| | |
|------------|--------------------------------------------------------------------------------------------------------------------------------------------------------------------------------------------------------------------------------------------------------------------------------------------------------------------------------|
| diagram | |
| namespace | urn:bridgeall-com:cmaservice:data:v3 |
| properties | isRef 0 content complex |
| children | T012.7_UpdateLiveRateableValue |
| source | <pre> <xs:element name="T012.7_UpdateLiveRateableValues"> <xs:complexType> <xs:sequence maxOccurs="unbounded"> <xs:element name="T012.7_UpdateLiveRateableValue" type="T012.7_UpdateLiveRateableValueType"/> </xs:sequence> </xs:complexType> </xs:element> </pre> |

element

MessageType/T012.7_UpdateLiveRateableValues/T012.7_UpdateLiveRateableValue

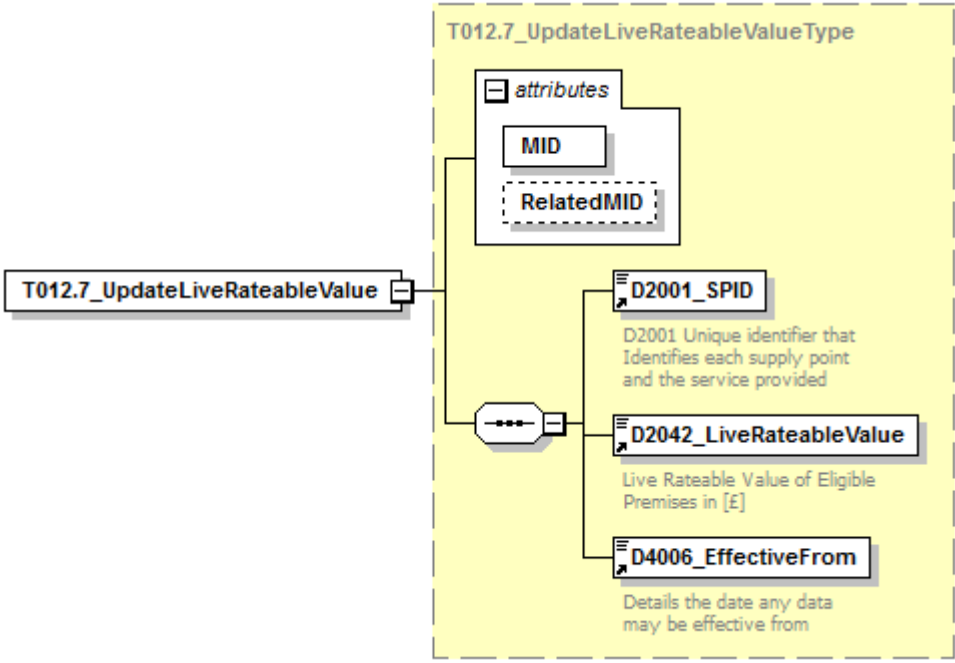
| <p>diagram</p> |  | | | | | | | | | | | | | | | | | | |
|----------------------------|--------------------------------------------------------------------------------------------------------------------------------------------------------------------------------------------------------------------------------------------------------------------------------------------------------------------------------------------------------------------------------------------------------------------------------------------|----------|---------|-------|------------|-------|------------|---------------------|-------------------------------|----------|--|--|--|----------------------------|-------------------------------|----------|--|--|--|
| <p>namespace</p> | <p>urn:bridgeall-com:cmaservice:data:v3</p> | | | | | | | | | | | | | | | | | | |
| <p>type</p> | <p>T012.7_UpdateLiveRateableValueType</p> | | | | | | | | | | | | | | | | | | |
| <p>properties</p> | <p>isRef 0 content complex</p> | | | | | | | | | | | | | | | | | | |
| <p>children</p> | <p>D2001_SPID D2042_LiveRateableValue D4006_EffectiveFrom</p> | | | | | | | | | | | | | | | | | | |
| <p>attributes</p> | <table border="1"> <thead> <tr> <th>Name</th> <th>Type</th> <th>Use</th> <th>Default</th> <th>Fixed</th> <th>annotation</th> </tr> </thead> <tbody> <tr> <td>MID</td> <td>MessageIdType</td> <td>required</td> <td></td> <td></td> <td></td> </tr> <tr> <td>RelatedMID</td> <td>MessageIdType</td> <td>optional</td> <td></td> <td></td> <td></td> </tr> </tbody> </table> | Name | Type | Use | Default | Fixed | annotation | MID | MessageIdType | required | | | | RelatedMID | MessageIdType | optional | | | |
| Name | Type | Use | Default | Fixed | annotation | | | | | | | | | | | | | | |
| MID | MessageIdType | required | | | | | | | | | | | | | | | | | |
| RelatedMID | MessageIdType | optional | | | | | | | | | | | | | | | | | |
| <p>source</p> | <pre><xs:element name="T012.7_UpdateLiveRateableValue" type="T012.7_UpdateLiveRateableValueType"/></pre> | | | | | | | | | | | | | | | | | | |

element MessageType/T013.0_MeterUpdates

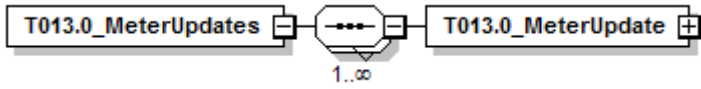
| | |
|-------------------|-----------------------------------------------------------------------------------------------------------------------------------------------------------------------------------------------------------------------------------------------------------------------------------|
| <p>diagram</p> |  |
| <p>namespace</p> | <p>urn:bridgeall-com:cmaservice:data:v3</p> |
| <p>properties</p> | <p>isRef 0 content complex</p> |
| <p>children</p> | <p>T013.0_MeterUpdate</p> |
| <p>source</p> | <pre><xs:element name="T013.0_MeterUpdates"> <xs:complexType> <xs:sequence maxOccurs="unbounded"> <xs:element name="T013.0_MeterUpdate" type="MeterUpdateType"/> </xs:sequence> </xs:complexType> </xs:element></pre> |

element **MessageType/T013.0_MeterUpdates/T013.0_MeterUpdate**

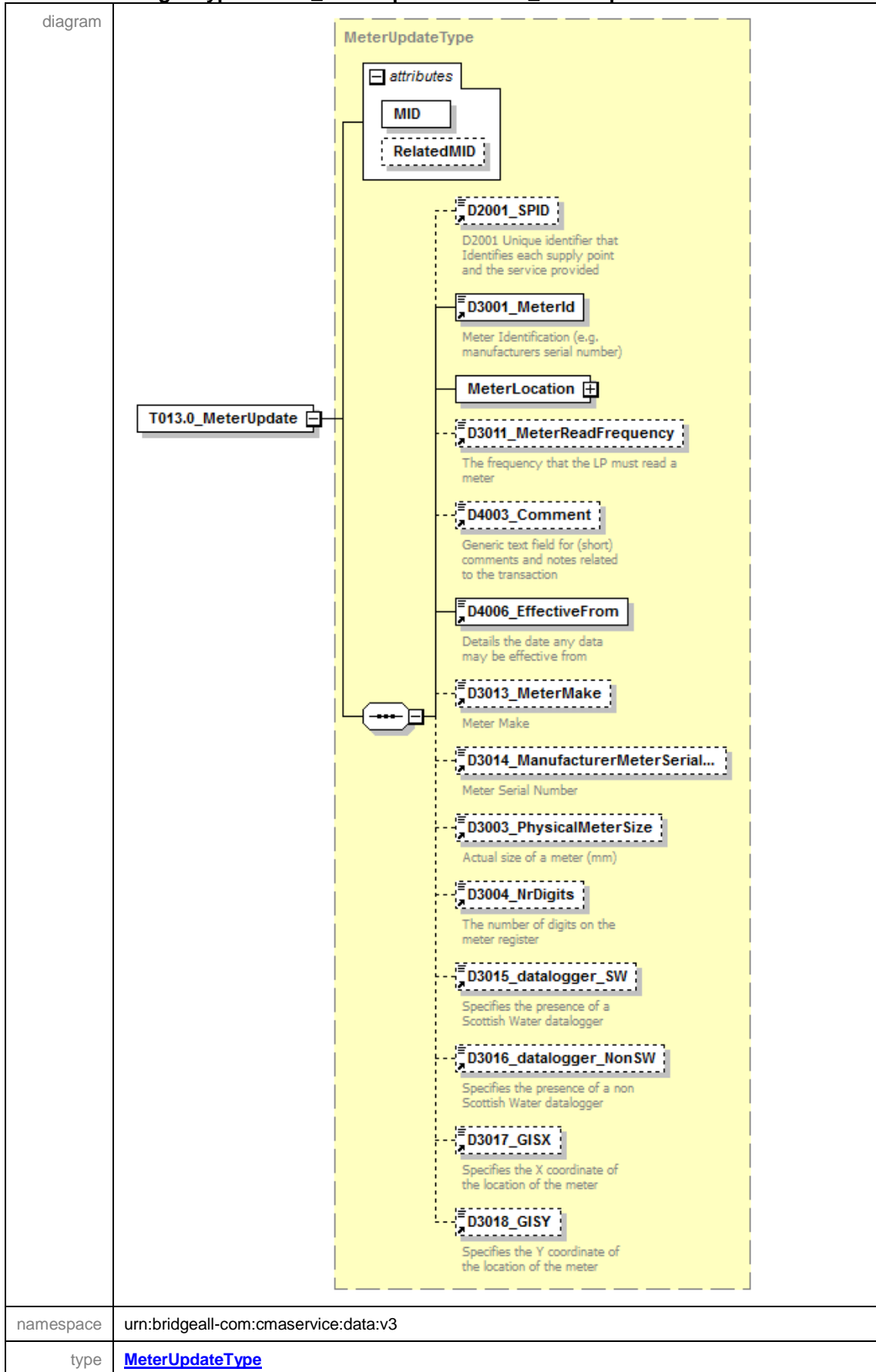

| properties | isRef 0 content complex | | | | | | | | | | | | | | | | | | |
|----------------------------|-------------------------------------------------------------------------------------------------------------------------------------------------------------------------------------------------------------------------------------------------------------------------------------------------------------------------------------------------------------------------------------------------------------------------------------------------------------------------------------------|----------|---------|-------|------------|-------|------------|---------------------|-------------------------------|----------|--|--|--|----------------------------|-------------------------------|----------|--|--|--|
| children | D2001 SPID D3001 MeterId MeterLocation D3011 MeterReadFrequency D4003 Comment D4006 EffectiveFrom D3013 MeterMake D3014 ManufacturerMeterSerialNr D3003 PhysicalMeterSize D3004 NrDigits D3015 datalogger SW D3016 datalogger NonSW D3017 GISX D3018 GISY | | | | | | | | | | | | | | | | | | |
| attributes | <table border="1"> <thead> <tr> <th>Name</th> <th>Type</th> <th>Use</th> <th>Default</th> <th>Fixed</th> <th>annotation</th> </tr> </thead> <tbody> <tr> <td>MID</td> <td>MessageIdType</td> <td>required</td> <td></td> <td></td> <td></td> </tr> <tr> <td>RelatedMID</td> <td>MessageIdType</td> <td>optional</td> <td></td> <td></td> <td></td> </tr> </tbody> </table> | Name | Type | Use | Default | Fixed | annotation | MID | MessageIdType | required | | | | RelatedMID | MessageIdType | optional | | | |
| Name | Type | Use | Default | Fixed | annotation | | | | | | | | | | | | | | |
| MID | MessageIdType | required | | | | | | | | | | | | | | | | | |
| RelatedMID | MessageIdType | optional | | | | | | | | | | | | | | | | | |
| source | <code><xs:element name="T013.0_MeterUpdate" type="MeterUpdateType"/></code> | | | | | | | | | | | | | | | | | | |

element MessagesType/T013.2_UpdateMeterLocations

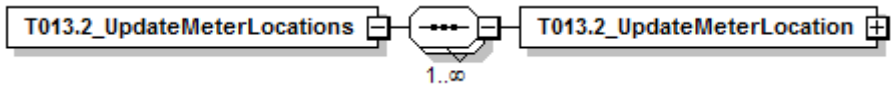
| | |
|------------|-------------------------------------------------------------------------------------------------------------------------------------------------------------------------------------------------------------------------------------------------------------------------------------------------------------------------------------------------|
| diagram |  |
| namespace | urn:bridgeall-com:cmaservice:data:v3 |
| properties | isRef 0 content complex |
| children | T013.2_UpdateMeterLocation |
| source | <code><xs:element name="T013.2_UpdateMeterLocations"> <xs:complexType> <xs:sequence maxOccurs="unbounded"> <xs:element name="T013.2_UpdateMeterLocation" type="UpdateMeterLocationType"/> </xs:sequence> </xs:complexType> </xs:element></code> |

element **MessagesType/T013.2_UpdateMeterLocations/T013.2_UpdateMeterLocation**

| diagram | <p>The diagram illustrates the structure of the UpdateMeterLocationType element. It is a complex type containing an attributes group with MID and RelatedMID. The main content is a sequence of four elements: D2001_SPID, D3001_MeterId, D3019_GISZFreeDescriptor, and D3025_MeterLocationCode.</p> <ul style="list-style-type: none"> D2001_SPID: D2001 Unique identifier that Identifies each supply point and the service provided D3001_MeterId: Meter Identification (e.g. manufacturers serial number) D3019_GISZFreeDescriptor: Specifies the Z Free Descriptor of the location of the meter D3025_MeterLocationCode: Meter Location Code | | | | | | | | | | | | | | | | | | |
|----------------------------|---------------------------------------------------------------------------------------------------------------------------------------------------------------------------------------------------------------------------------------------------------------------------------------------------------------------------------------------------------------------------------------------------------------------------------------------------------------------------------------------------------------------------------------------------------------------------------------------------------------------------------------------------------------------------------------------------------------------------------------------------------------------------------|----------|---------|-------|------------|-------|------------|---------------------|-------------------------------|----------|--|--|--|----------------------------|-------------------------------|----------|--|--|--|
| namespace | urn:bridgeall-com:cmaservice:data:v3 | | | | | | | | | | | | | | | | | | |
| type | UpdateMeterLocationType | | | | | | | | | | | | | | | | | | |
| properties | isRef 0 content complex | | | | | | | | | | | | | | | | | | |
| children | D2001_SPID D3001_MeterId D3019_GISZFreeDescriptor D3025_MeterLocationCode | | | | | | | | | | | | | | | | | | |
| attributes | <table border="1"> <thead> <tr> <th>Name</th> <th>Type</th> <th>Use</th> <th>Default</th> <th>Fixed</th> <th>annotation</th> </tr> </thead> <tbody> <tr> <td>MID</td> <td>MessageIdType</td> <td>required</td> <td></td> <td></td> <td></td> </tr> <tr> <td>RelatedMID</td> <td>MessageIdType</td> <td>optional</td> <td></td> <td></td> <td></td> </tr> </tbody> </table> | Name | Type | Use | Default | Fixed | annotation | MID | MessageIdType | required | | | | RelatedMID | MessageIdType | optional | | | |
| Name | Type | Use | Default | Fixed | annotation | | | | | | | | | | | | | | |
| MID | MessageIdType | required | | | | | | | | | | | | | | | | | |
| RelatedMID | MessageIdType | optional | | | | | | | | | | | | | | | | | |
| source | <code><xs:element name="T013.2_UpdateMeterLocation" type="UpdateMeterLocationType"/></code> | | | | | | | | | | | | | | | | | | |

element **MessagesType/T014.0_ChargeableMeterUpdates**

| | |
|------------|-----------------------------------------------------------------------------------------------------------------------------------------------------------------------------------------------------------------------------------------------------------------------------------------------|
| diagram | <p>The diagram illustrates the structure of the T014.0_ChargeableMeterUpdates element. It is a complex type containing a sequence of one or more T014.0_ChargeableMeterUpdate elements.</p> |
| namespace | urn:bridgeall-com:cmaservice:data:v3 |
| properties | isRef 0 content complex |
| children | T014.0_ChargeableMeterUpdate |
| source | <pre> <xs:element name="T014.0_ChargeableMeterUpdates"> <xs:complexType> <xs:sequence maxOccurs="unbounded"> <xs:element name="T014.0_ChargeableMeterUpdate" type="ChargeableMeterUpdateType"/> </xs:sequence> </xs:complexType> </pre> |

</xs:element>

element

MessagesType/T014.0_ChargeableMeterUpdates/T014.0_ChargeableMeterUpdate

| <p>diagram</p> | | | | | | | | | | | | | | | | | | | |
|----------------------------|--------------------------------------------------------------------------------------------------------------------------------------------------------------------------------------------------------------------------------------------------------------------------------------------------------------------------------------------------------------------------------------------------------------------------------------------|----------|---------|-------|------------|-------|------------|---------------------|-------------------------------|----------|--|--|--|----------------------------|-------------------------------|----------|--|--|--|
| <p>namespace</p> | <p>urn:bridgeall-com:cmaservice:data:v3</p> | | | | | | | | | | | | | | | | | | |
| <p>type</p> | <p>ChargeableMeterUpdateType</p> | | | | | | | | | | | | | | | | | | |
| <p>properties</p> | <p>isRef 0 content complex</p> | | | | | | | | | | | | | | | | | | |
| <p>children</p> | <p>D2001_SPID D3001_MeterId D3002_ChargeableMeterSize D3005_SewerageChargeableMeterSize D4003_Comment D3007_ReturnToSewerAllowance D4006_EffectiveFrom</p> | | | | | | | | | | | | | | | | | | |
| <p>attributes</p> | <table border="1"> <thead> <tr> <th>Name</th> <th>Type</th> <th>Use</th> <th>Default</th> <th>Fixed</th> <th>annotation</th> </tr> </thead> <tbody> <tr> <td>MID</td> <td>MessageIdType</td> <td>required</td> <td></td> <td></td> <td></td> </tr> <tr> <td>RelatedMID</td> <td>MessageIdType</td> <td>optional</td> <td></td> <td></td> <td></td> </tr> </tbody> </table> | Name | Type | Use | Default | Fixed | annotation | MID | MessageIdType | required | | | | RelatedMID | MessageIdType | optional | | | |
| Name | Type | Use | Default | Fixed | annotation | | | | | | | | | | | | | | |
| MID | MessageIdType | required | | | | | | | | | | | | | | | | | |
| RelatedMID | MessageIdType | optional | | | | | | | | | | | | | | | | | |
| <p>source</p> | <pre><xs:element name="T014.0_ChargeableMeterUpdate" type="ChargeableMeterUpdateType"/></pre> | | | | | | | | | | | | | | | | | | |

element **MessagesType/T015.0_DisconnectionDeclarations**

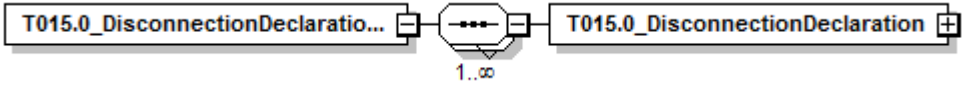
| | |
|------------|-----------------------------------------------------------------------------------------------------------------------------------------------------------------------------------------------------------------------------------------------------------------------------------------------------------------------|
| diagram |  |
| namespace | urn:bridgeall-com:cmaservice:data:v3 |
| properties | isRef 0 content complex |
| children | T015.0_DisconnectionDeclaration |
| source | <pre><xs:element name="T015.0_DisconnectionDeclarations"> <xs:complexType> <xs:sequence maxOccurs="unbounded"> <xs:element name="T015.0_DisconnectionDeclaration" type="DisconnectionType"/> </xs:sequence> </xs:complexType> </xs:element></pre> |

element **MessagesType/T015.0_DisconnectionDeclarations/T015.0_DisconnectionDeclaration**

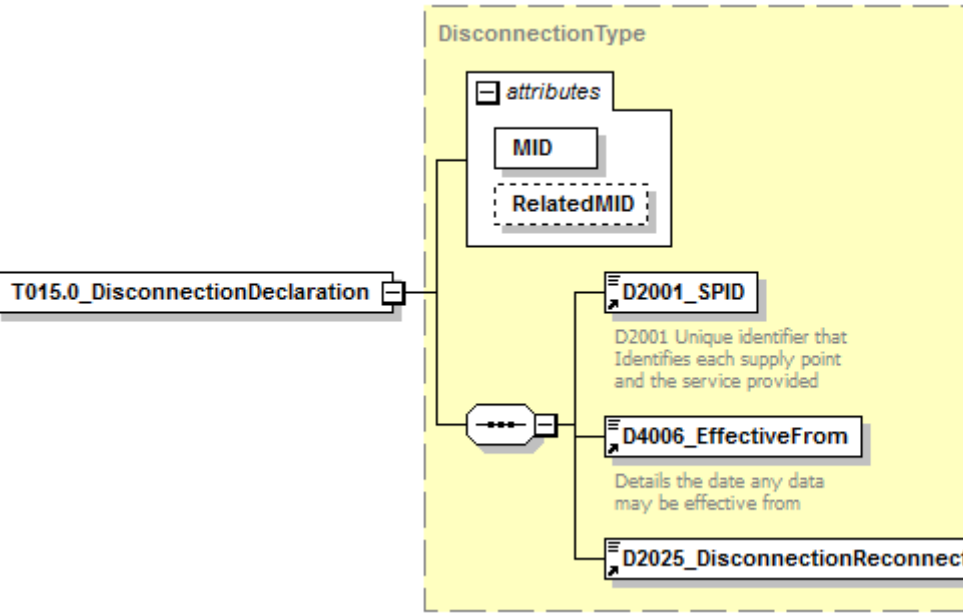
| diagram |  | | | | | | | | | | | | | | | | | | |
|----------------------------|--------------------------------------------------------------------------------------------------------------------------------------------------------------------------------------------------------------------------------------------------------------------------------------------------------------------------------------------------------------------------------------------------------------------------------------------|----------|---------|-------|------------|-------|------------|---------------------|-------------------------------|----------|--|--|--|----------------------------|-------------------------------|----------|--|--|--|
| namespace | urn:bridgeall-com:cmaservice:data:v3 | | | | | | | | | | | | | | | | | | |
| type | DisconnectionType | | | | | | | | | | | | | | | | | | |
| properties | isRef 0 content complex | | | | | | | | | | | | | | | | | | |
| children | D2001_SPID D4006_EffectiveFrom D2025_DisconnectionReconnect | | | | | | | | | | | | | | | | | | |
| attributes | <table border="1"> <thead> <tr> <th>Name</th> <th>Type</th> <th>Use</th> <th>Default</th> <th>Fixed</th> <th>annotation</th> </tr> </thead> <tbody> <tr> <td>MID</td> <td>MessageIdType</td> <td>required</td> <td></td> <td></td> <td></td> </tr> <tr> <td>RelatedMID</td> <td>MessageIdType</td> <td>optional</td> <td></td> <td></td> <td></td> </tr> </tbody> </table> | Name | Type | Use | Default | Fixed | annotation | MID | MessageIdType | required | | | | RelatedMID | MessageIdType | optional | | | |
| Name | Type | Use | Default | Fixed | annotation | | | | | | | | | | | | | | |
| MID | MessageIdType | required | | | | | | | | | | | | | | | | | |
| RelatedMID | MessageIdType | optional | | | | | | | | | | | | | | | | | |
| source | <pre><xs:element name="T015.0_DisconnectionDeclaration" type="DisconnectionType"/></pre> | | | | | | | | | | | | | | | | | | |

element **MessagesType/T016.0_UnmeasureableDeclarations**

| | |
|------------|-----------------------------------------------------------------------------------------------------------------------------------------------------------------------------------------------------------------------------------------------------------------------------------------------------------------------------------------|
| diagram | |
| namespace | urn:bridgeall-com:cmaservice:data:v3 |
| properties | isRef 0 content complex |
| children | T016.0_UnmeasureableDeclaration |
| source | <pre><xs:element name="T016.0_UnmeasureableDeclarations"> <xs:complexType> <xs:sequence maxOccurs="unbounded"> <xs:element name="T016.0_UnmeasureableDeclaration" type="T016.0_UnmeasureableDeclarationType"/> </xs:sequence> </xs:complexType> </xs:element></pre> |

element **MessagesType/T016.0_UnmeasureableDeclarations/T016.0_UnmeasureableDeclaration**

| diagram | | | | | | | | | | | | | | | | | | | |
|----------------------------|--------------------------------------------------------------------------------------------------------------------------------------------------------------------------------------------------------------------------------------------------------------------------------------------------------------------------------------------------------------------------------------------------------------------------------------------|----------|---------|-------|------------|-------|------------|---------------------|-------------------------------|----------|--|--|--|----------------------------|-------------------------------|----------|--|--|--|
| namespace | urn:bridgeall-com:cmaservice:data:v3 | | | | | | | | | | | | | | | | | | |
| type | T016.0_UnmeasureableDeclarationType | | | | | | | | | | | | | | | | | | |
| properties | isRef 0 content complex | | | | | | | | | | | | | | | | | | |
| children | D2001_SPID D2024_Unmeasurable D4006_EffectiveFrom | | | | | | | | | | | | | | | | | | |
| attributes | <table border="1"> <thead> <tr> <th>Name</th> <th>Type</th> <th>Use</th> <th>Default</th> <th>Fixed</th> <th>annotation</th> </tr> </thead> <tbody> <tr> <td>MID</td> <td>MessageIdType</td> <td>required</td> <td></td> <td></td> <td></td> </tr> <tr> <td>RelatedMID</td> <td>MessageIdType</td> <td>optional</td> <td></td> <td></td> <td></td> </tr> </tbody> </table> | Name | Type | Use | Default | Fixed | annotation | MID | MessageIdType | required | | | | RelatedMID | MessageIdType | optional | | | |
| Name | Type | Use | Default | Fixed | annotation | | | | | | | | | | | | | | |
| MID | MessageIdType | required | | | | | | | | | | | | | | | | | |
| RelatedMID | MessageIdType | optional | | | | | | | | | | | | | | | | | |

| | |
|--------|--------------------------------------------------------------------------------------------------------------------|
| source | <code><xs:element name="T016.0_UnmeasureableDeclaration" type="T016.0_UnmeasureableDeclarationType"/></code> |
|--------|--------------------------------------------------------------------------------------------------------------------|

element **MessagesType/T017.0_MeterSwaps**

| | |
|------------|-------------------------------------------------------------------------------------------------------------------------------------------------------------------------------------------------------------------------------------------------------------------------------------|
| diagram | |
| namespace | urn:bridgeall-com:cmaservice:data:v3 |
| properties | isRef 0 content complex |
| children | T017.0_MeterSwap |
| source | <code><xs:element name="T017.0_MeterSwaps"> <xs:complexType> <xs:sequence maxOccurs="unbounded"> <xs:element name="T017.0_MeterSwap" type="MeterSwapType"/> </xs:sequence> </xs:complexType> </xs:element></code> |

element **MessagesType/T017.0_MeterSwaps/T017.0_MeterSwap**

| | | | | | | |
|------------|-----------------------------------------------------------------------------------------------------------|-------------------------------|----------|---------|-------|------------|
| diagram | | | | | | |
| namespace | urn:bridgeall-com:cmaservice:data:v3 | | | | | |
| type | MeterSwapType | | | | | |
| properties | isRef 0 content complex | | | | | |
| children | D2001_SPID NewMeter OldMeter D3012_ReRead | | | | | |
| attributes | Name | Type | Use | Default | Fixed | annotation |
| | MID | MessageIdType | required | | | |
| | RelatedMID | MessageIdType | optional | | | |

| | |
|--------|-------------------------------------------------------------------------------|
| source | <code><xs:element name="T017.0_MeterSwap" type="MeterSwapType"/></code> |
|--------|-------------------------------------------------------------------------------|

element **MessagesType/T021.0_NewDPIDs**

| | |
|------------|----------------------------------------------------------------------------------------------------------------------------------------------------------------------------------------------------------------------------------------------------------------------------------|
| diagram | |
| namespace | urn:bridgeall-com:cmaservice:data:v3 |
| properties | isRef 0 content complex |
| children | T021.0_NewDPID |
| source | <pre> <xs:element name="T021.0_NewDPIDs"> <xs:complexType> <xs:sequence maxOccurs="unbounded"> <xs:element name="T021.0_NewDPID" type="DPIDNotificationType"/> </xs:sequence> </xs:complexType> </xs:element> </pre> |

element **MessagesType/T021.0_NewDPIDs/T021.0_NewDPID**

| | |
|------------------|---------------------------------------------|
| <p>diagram</p> | |
| <p>namespace</p> | <p>urn:bridgeall-com:cmaservice:data:v3</p> |
| <p>type</p> | <p>DPIDNotificationType</p> |

| properties | isRef 0 content complex | | | | | | | | | | | | | | | | | | |
|----------------------------|-----------------------------------------------------------------------------------------------------------------------------------------------------------------------------------------------------------------------------------------------------------------------------------------------------------------------------------------------------------------------------------------------------------------------------------------------------------------------------|----------|---------|-------|------------|-------|------------|---------------------|-------------------------------|----------|--|--|--|----------------------------|-------------------------------|----------|--|--|--|
| children | D2001_SPID D6001_DPID D4006_EffectiveFrom D6003_CDV D6004_sBODL D6005_TSSL D6006_Ot D6007_St D6009_Non-domesticAllowance D6010_SDTIndicator Address D6002_TeYVe D6011_TETreatment D6012_PcentAllowance D6013_FixedAllowance | | | | | | | | | | | | | | | | | | |
| attributes | <table border="1"> <thead> <tr> <th>Name</th> <th>Type</th> <th>Use</th> <th>Default</th> <th>Fixed</th> <th>annotation</th> </tr> </thead> <tbody> <tr> <td>MID</td> <td>MessageIdType</td> <td>required</td> <td></td> <td></td> <td></td> </tr> <tr> <td>RelatedMID</td> <td>MessageIdType</td> <td>optional</td> <td></td> <td></td> <td></td> </tr> </tbody> </table> | Name | Type | Use | Default | Fixed | annotation | MID | MessageIdType | required | | | | RelatedMID | MessageIdType | optional | | | |
| Name | Type | Use | Default | Fixed | annotation | | | | | | | | | | | | | | |
| MID | MessageIdType | required | | | | | | | | | | | | | | | | | |
| RelatedMID | MessageIdType | optional | | | | | | | | | | | | | | | | | |
| source | <code><xs:element name="T021.0_NewDPID" type="DPIDNotificationType"/></code> | | | | | | | | | | | | | | | | | | |

element **MessagesType/T022.0_TEUpdates**

| | |
|------------|----------------------------------------------------------------------------------------------------------------------------------------------------------------------------------------------------------------------------------------------------------------------------|
| diagram | <pre> sequenceDiagram participant T022.0_TEUpdates as T022.0_TEUpdates participant T022.0_TEUpdate as T022.0_TEUpdate T022.0_TEUpdates --> T022.0_TEUpdate : 1..∞ </pre> |
| namespace | urn:bridgeall-com:cmaservice:data:v3 |
| properties | isRef 0 content complex |
| children | T022.0_TEUpdate |
| source | <pre> <xs:element name="T022.0_TEUpdates"> <xs:complexType> <xs:sequence maxOccurs="unbounded"> <xs:element name="T022.0_TEUpdate" type="TEUpdateType"/> </xs:sequence> </xs:complexType> </xs:element> </pre> |

element **MessagesType/T022.0_TEUpdates/T022.0_TEUpdate**

| diagram | | | | | | | | | | | | | | | | | | | |
|----------------------------|--------------------------------------------------------------------------------------------------------------------------------------------------------------------------------------------------------------------------------------------------------------------------------------------------------------------------------------------------------------------------------------------------------------------------------------------|----------|---------|-------|------------|-------|------------|---------------------|-------------------------------|----------|--|--|--|----------------------------|-------------------------------|----------|--|--|--|
| namespace | urn:bridgeall-com:cmaservice:data:v3 | | | | | | | | | | | | | | | | | | |
| type | TEUpdateType | | | | | | | | | | | | | | | | | | |
| properties | isRef 0 content complex | | | | | | | | | | | | | | | | | | |
| children | D2001_SPID D6001_DPID D4006_EffectiveFrom D6006_Ot D6007_St | | | | | | | | | | | | | | | | | | |
| attributes | <table border="1"> <thead> <tr> <th>Name</th> <th>Type</th> <th>Use</th> <th>Default</th> <th>Fixed</th> <th>annotation</th> </tr> </thead> <tbody> <tr> <td>MID</td> <td>MessageIdType</td> <td>required</td> <td></td> <td></td> <td></td> </tr> <tr> <td>RelatedMID</td> <td>MessageIdType</td> <td>optional</td> <td></td> <td></td> <td></td> </tr> </tbody> </table> | Name | Type | Use | Default | Fixed | annotation | MID | MessageIdType | required | | | | RelatedMID | MessageIdType | optional | | | |
| Name | Type | Use | Default | Fixed | annotation | | | | | | | | | | | | | | |
| MID | MessageIdType | required | | | | | | | | | | | | | | | | | |
| RelatedMID | MessageIdType | optional | | | | | | | | | | | | | | | | | |
| source | <code><xs:element name="T022.0_TEUpdate" type="TEUpdateType"/></code> | | | | | | | | | | | | | | | | | | |

element **MessagesType/T023.0_MeterAssociations**

| | |
|------------|--------------------------------------------------------------------------------------------------------------------------------------------------------------------------------------------|
| diagram | |
| namespace | urn:bridgeall-com:cmaservice:data:v3 |
| properties | isRef 0 content complex |
| children | T023.0_MeterAssociation |
| source | <pre> <xs:element name="T023.0_MeterAssociations"> <xs:complexType> <xs:sequence maxOccurs="unbounded"> <xs:element name="T023.0_MeterAssociation" </pre> |

```

type="MeterAssociationType"/>
</xs:sequence>
</xs:complexType>
</xs:element>

```

element **MessagesType/T023.0_MeterAssociations/T023.0_MeterAssociation**

| diagram | | | | | | | | | | | | | | | | | | | |
|----------------------------|--------------------------------------------------------------------------------------------------------------------------------------------------------------------------------------------------------------------------------------------------------------------------------------------------------------------------------------------------------------------------------------------------------------------------------------------|----------|---------|-------|------------|-------|------------|---------------------|-------------------------------|----------|--|--|--|----------------------------|-------------------------------|----------|--|--|--|
| namespace | urn:bridgeall-com:cmaservice:data:v3 | | | | | | | | | | | | | | | | | | |
| type | MeterAssociationType | | | | | | | | | | | | | | | | | | |
| properties | isRef 0 content complex | | | | | | | | | | | | | | | | | | |
| children | D2001_SPID D6001_DPID D3001_MeterId D4006_EffectiveFrom D3024_MDVol | | | | | | | | | | | | | | | | | | |
| attributes | <table border="1"> <thead> <tr> <th>Name</th> <th>Type</th> <th>Use</th> <th>Default</th> <th>Fixed</th> <th>annotation</th> </tr> </thead> <tbody> <tr> <td>MID</td> <td>MessageIdType</td> <td>required</td> <td></td> <td></td> <td></td> </tr> <tr> <td>RelatedMID</td> <td>MessageIdType</td> <td>optional</td> <td></td> <td></td> <td></td> </tr> </tbody> </table> | Name | Type | Use | Default | Fixed | annotation | MID | MessageIdType | required | | | | RelatedMID | MessageIdType | optional | | | |
| Name | Type | Use | Default | Fixed | annotation | | | | | | | | | | | | | | |
| MID | MessageIdType | required | | | | | | | | | | | | | | | | | |
| RelatedMID | MessageIdType | optional | | | | | | | | | | | | | | | | | |
| source | <xs:element name="T023.0_MeterAssociation" type="MeterAssociationType"/> | | | | | | | | | | | | | | | | | | |

element **MessagesType/T024.0_MeterDisAssociations**

| | |
|-----------|--------------------------------------|
| diagram | |
| namespace | urn:bridgeall-com:cmaservice:data:v3 |

| | |
|------------|-----------------------------------------------------------------------------------------------------------------------------------------------------------------------------------------------------------------------------------------------------------------------------------------------------------|
| properties | isRef 0 content complex |
| children | T024.0_MeterDisAssociation |
| source | <pre><xs:element name="T024.0_MeterDisAssociations"> <xs:complexType> <xs:sequence maxOccurs="unbounded"> <xs:element name="T024.0_MeterDisAssociation" type="MeterDisAssociationType"/> </xs:sequence> </xs:complexType> </xs:element></pre> |

element **MessagesType/T024.0_MeterDisAssociations/T024.0_MeterDisAssociation**

| diagram | | | | | | | | | | | | | | | | | | | |
|----------------------------|--------------------------------------------------------------------------------------------------------------------------------------------------------------------------------------------------------------------------------------------------------------------------------------------------------------------------------------------------------------------------------------------------------------------------------------------|----------|---------|-------|------------|-------|------------|---------------------|-------------------------------|----------|--|--|--|----------------------------|-------------------------------|----------|--|--|--|
| namespace | urn:bridgeall-com:cmaservice:data:v3 | | | | | | | | | | | | | | | | | | |
| type | MeterDisAssociationType | | | | | | | | | | | | | | | | | | |
| properties | isRef 0 content complex | | | | | | | | | | | | | | | | | | |
| children | D2001_SPID D6001_DPID D3001_MeterId D4006_EffectiveFrom | | | | | | | | | | | | | | | | | | |
| attributes | <table border="1"> <thead> <tr> <th>Name</th> <th>Type</th> <th>Use</th> <th>Default</th> <th>Fixed</th> <th>annotation</th> </tr> </thead> <tbody> <tr> <td>MID</td> <td>MessageIdType</td> <td>required</td> <td></td> <td></td> <td></td> </tr> <tr> <td>RelatedMID</td> <td>MessageIdType</td> <td>optional</td> <td></td> <td></td> <td></td> </tr> </tbody> </table> | Name | Type | Use | Default | Fixed | annotation | MID | MessageIdType | required | | | | RelatedMID | MessageIdType | optional | | | |
| Name | Type | Use | Default | Fixed | annotation | | | | | | | | | | | | | | |
| MID | MessageIdType | required | | | | | | | | | | | | | | | | | |
| RelatedMID | MessageIdType | optional | | | | | | | | | | | | | | | | | |
| source | <pre><xs:element name="T024.0_MeterDisAssociation" type="MeterDisAssociationType"/></pre> | | | | | | | | | | | | | | | | | | |

element **MessagesType/T026.0_DiscontinueDPIDs**

| | |
|------------|-------------------------------------------------------------------------------------------------------------------------------------------------------------------------------------------------------------------------------------------------------------------------------------------------------|
| diagram | |
| namespace | urn:bridgeall-com:cmaservice:data:v3 |
| properties | isRef 0 content complex |
| children | T026.0_DiscontinueDPID |
| source | <pre><xs:element name="T026.0_DiscontinueDPIDs"> <xs:complexType> <xs:sequence maxOccurs="unbounded"> <xs:element name="T026.0_DiscontinueDPID" type="DiscontinueDPIDType"/> </xs:sequence> </xs:complexType> </xs:element></pre> |

element **MessagesType/T026.0_DiscontinueDPIDs/T026.0_DiscontinueDPID**

| diagram | | | | | | | | | | | | | | | | | | | |
|----------------------------|--------------------------------------------------------------------------------------------------------------------------------------------------------------------------------------------------------------------------------------------------------------------------------------------------------------------------------------------------------------------------------------------------------------------------------------------|----------|---------|-------|------------|-------|------------|---------------------|-------------------------------|----------|--|--|--|----------------------------|-------------------------------|----------|--|--|--|
| namespace | urn:bridgeall-com:cmaservice:data:v3 | | | | | | | | | | | | | | | | | | |
| type | DiscontinueDPIDType | | | | | | | | | | | | | | | | | | |
| properties | isRef 0 content complex | | | | | | | | | | | | | | | | | | |
| children | D2001_SPID D6001_DPID D4006_EffectiveFrom | | | | | | | | | | | | | | | | | | |
| attributes | <table border="1"> <thead> <tr> <th>Name</th> <th>Type</th> <th>Use</th> <th>Default</th> <th>Fixed</th> <th>annotation</th> </tr> </thead> <tbody> <tr> <td>MID</td> <td>MessageIDType</td> <td>required</td> <td></td> <td></td> <td></td> </tr> <tr> <td>RelatedMID</td> <td>MessageIDType</td> <td>optional</td> <td></td> <td></td> <td></td> </tr> </tbody> </table> | Name | Type | Use | Default | Fixed | annotation | MID | MessageIDType | required | | | | RelatedMID | MessageIDType | optional | | | |
| Name | Type | Use | Default | Fixed | annotation | | | | | | | | | | | | | | |
| MID | MessageIDType | required | | | | | | | | | | | | | | | | | |
| RelatedMID | MessageIDType | optional | | | | | | | | | | | | | | | | | |
| source | <pre><xs:element name="T026.0_DiscontinueDPID" type="DiscontinueDPIDType"/></pre> | | | | | | | | | | | | | | | | | | |

element **MessagesType/T027.0_DPIDUpdates**

| | |
|------------|----------------------------------------------------------------------------------------------------------------------------------------------------------------------------------------------------------------------------------------------------------------------------------|
| diagram | |
| namespace | urn:bridgeall-com:cmaservice:data:v3 |
| properties | isRef 0 content complex |
| children | T027.0 DPIDUpdate |
| source | <pre> <xs:element name="T027.0_DPIDUpdates"> <xs:complexType> <xs:sequence maxOccurs="unbounded"> <xs:element name="T027.0_DPIDUpdate" type="DPIDUpdateType"/> </xs:sequence> </xs:complexType> </xs:element> </pre> |

element **MessagesType/T027.0_DPIDUpdates/T027.0_DPIDUpdate**

| | |
|------------------|-------------------------------------------------------------------------------------------------------------------------------------------------------------------------------------------------------------------------------------------------------------------------------------------------------------------------------------------------------------------------------------------------------------------------------------------------------------------------------------------------------------------------------------------------------------------------------------------------------------------------------------------------------------------------------------------------------------------------------------------------------------------------------------------------------------------------------------------------------------------------------------------------------------------------------------------------------------------------------------------------------------------------------------------------------------------------------------------------------------------------------------------------------------------------------------------------------------------------------------------------------------------------------------------------------------------------------------------------------------------------------------------------------------------------------------------------------------------------------------------------------------------------------|
| <p>diagram</p> | <p>The diagram illustrates the structure of the DPIDUpdateType element. It is a complex type containing several attributes and elements. The attributes section includes MID and RelatedMID. The main body of the type contains the following elements:</p> <ul style="list-style-type: none"> D2001_SPID: D2001 Unique identifier that Identifies each supply point and the service provided. D6001_DPID: Discharge Point ID. D4006_EffectiveFrom: Details the date any data may be effective from. D6003_CDV: TE Availability data: Chargeable Daily Volume m3. D6004_sBODL: TE Availability data: Chargeable Settled Biochemical Oxygen Demand load (kg/day). D6005_TSSL: TE Availability data: Chargeable Total Suspended Solids load (kg/day). D6009_Non-domesticAllowance: Annual volume associated with the foul sewerage for the Discharge Point (m3). D6010_SDTIndicator: Seasonal Discharge Tariff Indicator - set as True to apply higher seasonal tariff. D6002_TEYVe: Trade Effluent Estimated Yearly Volume for a Discharge Point. Address: A complex type element. D4003_Comment: Generic text field for (short) comments and notes related to the transaction. D6012_PcentAllowance: DPID Percentage Allowance. D6013_FixedAllowance: DPID Fixed Allowance. |
| <p>namespace</p> | <p>urn:bridgeall-com:cmaservice:data:v3</p> |
| <p>type</p> | <p>DPIDUpdateType</p> |

| properties | isRef 0 content complex | | | | | | | | | | | | | | | | | | |
|----------------------------|--------------------------------------------------------------------------------------------------------------------------------------------------------------------------------------------------------------------------------------------------------------------------------------------------------------------------------------------------------------------------------------------------------------------------------------------|----------|---------|-------|------------|-------|------------|---------------------|-------------------------------|----------|--|--|--|----------------------------|-------------------------------|----------|--|--|--|
| children | D2001_SPID D6001_DPID D4006_EffectiveFrom D6003_CDV D6004_sBODL D6005_TSSL D6009_Non-domesticAllowance D6010_SDIndicator D6002_TYVe Address D4003_Comment D6012_PcentAllowance D6013_FixedAllowance | | | | | | | | | | | | | | | | | | |
| attributes | <table border="1"> <thead> <tr> <th>Name</th> <th>Type</th> <th>Use</th> <th>Default</th> <th>Fixed</th> <th>annotation</th> </tr> </thead> <tbody> <tr> <td>MID</td> <td>MessageIdType</td> <td>required</td> <td></td> <td></td> <td></td> </tr> <tr> <td>RelatedMID</td> <td>MessageIdType</td> <td>optional</td> <td></td> <td></td> <td></td> </tr> </tbody> </table> | Name | Type | Use | Default | Fixed | annotation | MID | MessageIdType | required | | | | RelatedMID | MessageIdType | optional | | | |
| Name | Type | Use | Default | Fixed | annotation | | | | | | | | | | | | | | |
| MID | MessageIdType | required | | | | | | | | | | | | | | | | | |
| RelatedMID | MessageIdType | optional | | | | | | | | | | | | | | | | | |
| source | <code><xs:element name="T027.0_DPIDUpdate" type="DPIDUpdateType"/></code> | | | | | | | | | | | | | | | | | | |

element **MessagesType/T028.1_Schedule3Updates**

| | |
|------------|-------------------------------------------------------------------------------------------------------------------------------------------------------------------------------------------------------------------------------------------------------------------------------------------------|
| diagram | |
| namespace | urn:bridgeall-com:cmaservice:data:v3 |
| properties | isRef 0 content complex |
| children | T028.1_Schedule3Update |
| source | <pre> <xs:element name="T028.1_Schedule3Updates"> <xs:complexType> <xs:sequence maxOccurs="unbounded"> <xs:element name="T028.1_Schedule3Update" type="Schedule3UpdateType"/> </xs:sequence> </xs:complexType> </xs:element> </pre> |

element **MessagesType/T028.1_Schedule3Updates/T028.1_Schedule3Update**

| diagram | | | | | | | | | | | | | | | | | | | |
|----------------------------|--------------------------------------------------------------------------------------------------------------------------------------------------------------------------------------------------------------------------------------------------------------------------------------------------------------------------------------------------------------------------------------------------------------------------------------------|----------|---------|-------|------------|-------|------------|---------------------|-------------------------------|----------|--|--|--|----------------------------|-------------------------------|----------|--|--|--|
| namespace | urn:bridgeall-com:cmaservice:data:v3 | | | | | | | | | | | | | | | | | | |
| type | Schedule3UpdateType | | | | | | | | | | | | | | | | | | |
| properties | isRef 0 content complex | | | | | | | | | | | | | | | | | | |
| children | D2001_SPID D2003_Schedule3 D4006_EffectiveFrom D6001_DPID | | | | | | | | | | | | | | | | | | |
| attributes | <table border="1"> <thead> <tr> <th>Name</th> <th>Type</th> <th>Use</th> <th>Default</th> <th>Fixed</th> <th>annotation</th> </tr> </thead> <tbody> <tr> <td>MID</td> <td>MessageIdType</td> <td>required</td> <td></td> <td></td> <td></td> </tr> <tr> <td>RelatedMID</td> <td>MessageIdType</td> <td>optional</td> <td></td> <td></td> <td></td> </tr> </tbody> </table> | Name | Type | Use | Default | Fixed | annotation | MID | MessageIdType | required | | | | RelatedMID | MessageIdType | optional | | | |
| Name | Type | Use | Default | Fixed | annotation | | | | | | | | | | | | | | |
| MID | MessageIdType | required | | | | | | | | | | | | | | | | | |
| RelatedMID | MessageIdType | optional | | | | | | | | | | | | | | | | | |
| source | <code><xs:element name="T028.1_Schedule3Update" type="Schedule3UpdateType"/></code> | | | | | | | | | | | | | | | | | | |

element **MessagesType/T029.1_SpecialArrangementsUpdates**

| | |
|------------|-----------------------------------------------------------------------------------------------------------------------------------------------------------------------------------------------------------------------------------------------------------------------------------------------------------|
| diagram | |
| namespace | urn:bridgeall-com:cmaservice:data:v3 |
| properties | isRef 0 content complex |
| children | T029.1_SpecialArrangementsUpdate |
| source | <pre> <xs:element name="T029.1_SpecialArrangementsUpdates"> <xs:complexType> <xs:sequence maxOccurs="unbounded"> <xs:element name="T029.1_SpecialArrangementsUpdate" type="SpecialArrangementsUpdateType"/> </xs:sequence> </xs:complexType> </pre> |

```
</xs:element>
```

element **MessagesType/T029.1_SpecialArrangementsUpdates/T029.1_SpecialArrangementsUpdate**

| diagram | | | | | | | | | | | | | | | | | | | |
|----------------------------|--------------------------------------------------------------------------------------------------------------------------------------------------------------------------------------------------------------------------------------------------------------------------------------------------------------------------------------------------------------------------------------------------------------------------------------------|----------|---------|-------|------------|-------|------------|---------------------|-------------------------------|----------|--|--|--|----------------------------|-------------------------------|----------|--|--|--|
| namespace | urn:bridgeall-com:cmaservice:data:v3 | | | | | | | | | | | | | | | | | | |
| type | SpecialArrangementsUpdateType | | | | | | | | | | | | | | | | | | |
| properties | isRef 0 content complex | | | | | | | | | | | | | | | | | | |
| children | D2001_SPID D4006_EffectiveFrom D2003_Schedule3 D2006_29e D2007_LargeVolAgreement | | | | | | | | | | | | | | | | | | |
| attributes | <table border="1"> <thead> <tr> <th>Name</th> <th>Type</th> <th>Use</th> <th>Default</th> <th>Fixed</th> <th>annotation</th> </tr> </thead> <tbody> <tr> <td>MID</td> <td>MessageIdType</td> <td>required</td> <td></td> <td></td> <td></td> </tr> <tr> <td>RelatedMID</td> <td>MessageIdType</td> <td>optional</td> <td></td> <td></td> <td></td> </tr> </tbody> </table> | Name | Type | Use | Default | Fixed | annotation | MID | MessageIdType | required | | | | RelatedMID | MessageIdType | optional | | | |
| Name | Type | Use | Default | Fixed | annotation | | | | | | | | | | | | | | |
| MID | MessageIdType | required | | | | | | | | | | | | | | | | | |
| RelatedMID | MessageIdType | optional | | | | | | | | | | | | | | | | | |
| source | <code><xs:element name="T029.1_SpecialArrangementsUpdate" type="SpecialArrangementsUpdateType"/></code> | | | | | | | | | | | | | | | | | | |

element **MessagesType/T029.3_PremisesSpecialArrangementsUpdates**

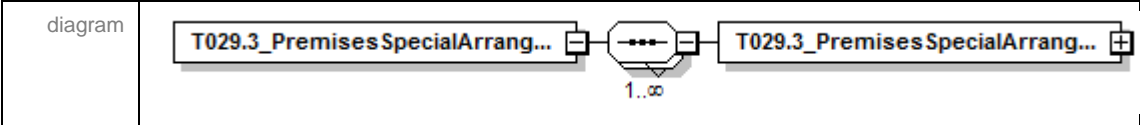

| | |
|------------|-----------------------------------------------------------------------------------------------------------------------------------------------------------------------------------------------------------------------------------------------------------------------------------------------------------------------------------------------------|
| namespace | urn:bridgeall-com:cmaservice:data:v3 |
| properties | isRef 0 content complex |
| children | T029.3_PremisesSpecialArrangementsUpdate |
| source | <pre><xs:element name="T029.3_PremisesSpecialArrangementsUpdates"> <xs:complexType> <xs:sequence maxOccurs="unbounded"> <xs:element name="T029.3_PremisesSpecialArrangementsUpdate" type="PremisesSpecialArrangementsUpdateType"/> </xs:sequence> </xs:complexType> </xs:element></pre> |

element
MessagesType/T029.3_PremisesSpecialArrangementsUpdates/T029.3_PremisesSpecialArrangementsUpdate

| diagram | | | | | | | | | | | | | | | | | | | |
|----------------------------|--------------------------------------------------------------------------------------------------------------------------------------------------------------------------------------------------------------------------------------------------------------------------------------------------------------------------------------------------------------------------------------------------------------------------------------------|----------|---------|-------|------------|-------|------------|---------------------|-------------------------------|----------|--|--|--|----------------------------|-------------------------------|----------|--|--|--|
| namespace | urn:bridgeall-com:cmaservice:data:v3 | | | | | | | | | | | | | | | | | | |
| type | PremisesSpecialArrangementsUpdateType | | | | | | | | | | | | | | | | | | |
| properties | isRef 0 content complex | | | | | | | | | | | | | | | | | | |
| children | D2001_SPID D4006_EffectiveFrom D2004_ExemptCustomerFlag D2041_PcentExemption | | | | | | | | | | | | | | | | | | |
| attributes | <table border="1"> <thead> <tr> <th>Name</th> <th>Type</th> <th>Use</th> <th>Default</th> <th>Fixed</th> <th>annotation</th> </tr> </thead> <tbody> <tr> <td>MID</td> <td>MessageIdType</td> <td>required</td> <td></td> <td></td> <td></td> </tr> <tr> <td>RelatedMID</td> <td>MessageIdType</td> <td>optional</td> <td></td> <td></td> <td></td> </tr> </tbody> </table> | Name | Type | Use | Default | Fixed | annotation | MID | MessageIdType | required | | | | RelatedMID | MessageIdType | optional | | | |
| Name | Type | Use | Default | Fixed | annotation | | | | | | | | | | | | | | |
| MID | MessageIdType | required | | | | | | | | | | | | | | | | | |
| RelatedMID | MessageIdType | optional | | | | | | | | | | | | | | | | | |
| source | <pre><xs:element name="T029.3_PremisesSpecialArrangementsUpdate" type="PremisesSpecialArrangementsUpdateType"/></pre> | | | | | | | | | | | | | | | | | | |

element **MessagesType/T032.0_CreateUpdateCustomerName**

| | |
|------------|----------------------------------------------------------------------------------------------------------------------------------------------------------------------------------------------------------------------------------------------------------------------------------------------------------------------------------|
| diagram | |
| namespace | urn:bridgeall-com:cmaservice:data:v3 |
| properties | isRef 0 content complex |
| children | T032.0_CreateUpdateCustomerName |
| source | <pre> <xs:element name="T032.0_CreateUpdateCustomerName"> <xs:complexType> <xs:sequence maxOccurs="unbounded"> <xs:element name="T032.0_CreateUpdateCustomerName" type="T032.0_CreateUpdateCustomerNameType"/> </xs:sequence> </xs:complexType> </xs:element> </pre> |

element **MessagesType/T032.0_CreateUpdateCustomerName/T032.0_CreateUpdateCustomerName**

| diagram | | | | | | | | | | | | | | | | | | | |
|----------------------------|--------------------------------------------------------------------------------------------------------------------------------------------------------------------------------------------------------------------------------------------------------------------------------------------------------------------------------------------------------------------------------------------------------------------------------------------|----------|---------|-------|------------|-------|------------|---------------------|-------------------------------|----------|--|--|--|----------------------------|-------------------------------|----------|--|--|--|
| namespace | urn:bridgeall-com:cmaservice:data:v3 | | | | | | | | | | | | | | | | | | |
| type | T032.0_CreateUpdateCustomerNameType | | | | | | | | | | | | | | | | | | |
| properties | isRef 0 content complex | | | | | | | | | | | | | | | | | | |
| children | D2001_SPID D2027_CustomerName D2028_CustomerNameType | | | | | | | | | | | | | | | | | | |
| attributes | <table border="1"> <thead> <tr> <th>Name</th> <th>Type</th> <th>Use</th> <th>Default</th> <th>Fixed</th> <th>annotation</th> </tr> </thead> <tbody> <tr> <td>MID</td> <td>MessageIdType</td> <td>required</td> <td></td> <td></td> <td></td> </tr> <tr> <td>RelatedMID</td> <td>MessageIdType</td> <td>optional</td> <td></td> <td></td> <td></td> </tr> </tbody> </table> | Name | Type | Use | Default | Fixed | annotation | MID | MessageIdType | required | | | | RelatedMID | MessageIdType | optional | | | |
| Name | Type | Use | Default | Fixed | annotation | | | | | | | | | | | | | | |
| MID | MessageIdType | required | | | | | | | | | | | | | | | | | |
| RelatedMID | MessageIdType | optional | | | | | | | | | | | | | | | | | |

| | |
|--------|--------------------------------------------------------------------------------------------------------------------|
| source | <code><xs:element name="T032.0_CreateUpdateCustomerName" type="T032.0_CreateUpdateCustomerNameType"/></code> |
|--------|--------------------------------------------------------------------------------------------------------------------|

element **MessagesType/T033.0_MeteredBuildings**

| | |
|------------|----------------------------------------------------------------------------------------------------------------------------------------------------------------------------------------------------------------------------------------------------------------------------------------------------------|
| diagram |  |
| namespace | urn:bridgeall-com:cmaservice:data:v3 |
| properties | isRef 0 content complex |
| children | T033.0_MeteredBuilding |
| source | <code><xs:element name="T033.0_MeteredBuildings"> <xs:complexType> <xs:sequence maxOccurs="unbounded"> <xs:element name="T033.0_MeteredBuilding" type="T033.0_MeteredBuilding"/> </xs:sequence> </xs:complexType> </xs:element></code> |

element **MessagesType/T033.0_MeteredBuildings/T033.0_MeteredBuilding**

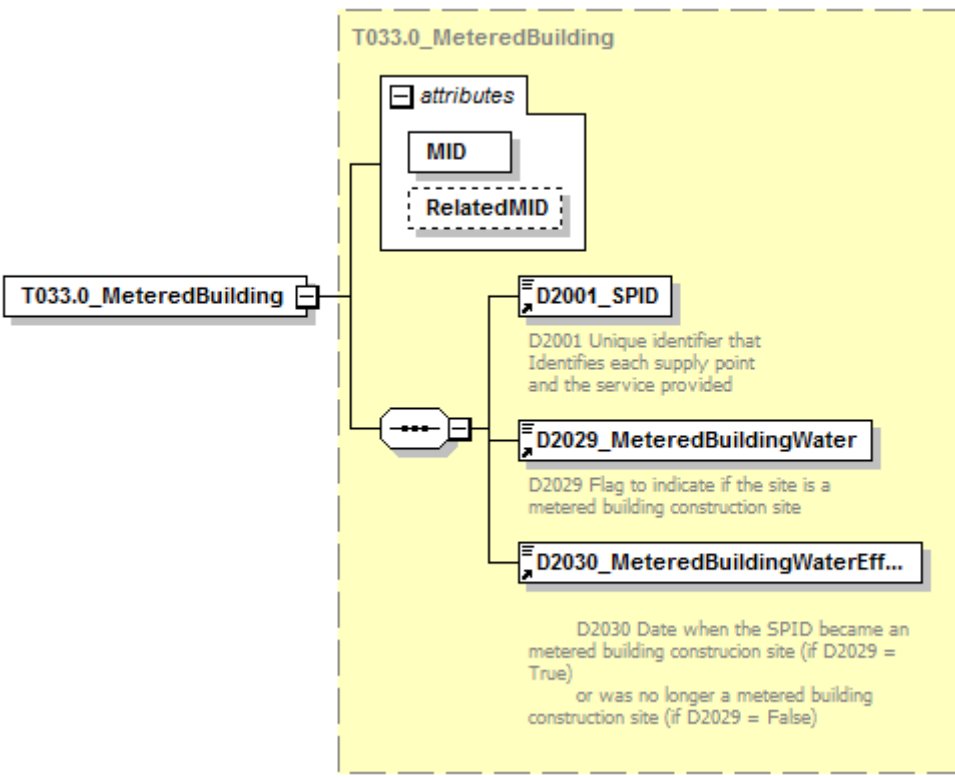
| | |
|------------|--------------------------------------------------------------------------------------|
| diagram |  |
| namespace | urn:bridgeall-com:cmaservice:data:v3 |
| type | T033.0_MeteredBuilding |
| properties | isRef 0 content complex |

| | | | | | | |
|------------|-------------------------------------------------------------------------------------------------------------------------------|-------------------------------|----------|---------|-------|------------|
| children | D2001_SPID D2029_MeteredBuildingWater D2030_MeteredBuildingWaterEffectiveDate | | | | | |
| attributes | Name | Type | Use | Default | Fixed | annotation |
| | MID | MessageIdType | required | | | |
| | RelatedMID | MessageIdType | optional | | | |
| source | <code><xs:element name="T033.0_MeteredBuilding" type="T033.0_MeteredBuilding"/></code> | | | | | |

element **MessagesType/T034.0_VacSchemeApplications**

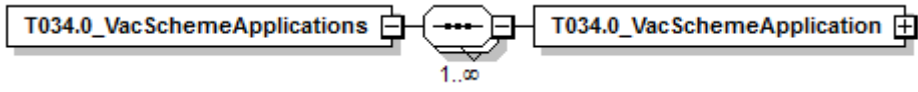
| | |
|------------|-----------------------------------------------------------------------------------------------------------------------------------------------------------------------------------------------------------------------------------------------------------------------------------------------------------------------------------------------|
| diagram |  |
| namespace | urn:bridgeall-com:cmaservice:data:v3 |
| properties | isRef 0 content complex |
| children | T034.0_VacSchemeApplication |
| source | <code><xs:element name="T034.0_VacSchemeApplications"> <xs:complexType> <xs:sequence maxOccurs="unbounded"> <xs:element name="T034.0_VacSchemeApplication" type="T034.0_VacSchemeApplication"/> </xs:sequence> </xs:complexType> </xs:element></code> |

element **MessagesType/T034.0_VacSchemeApplications/T034.0_VacSchemeApplication**

| <p>diagram</p> | <p>T034.0_VacSchemeApplication</p> <ul style="list-style-type: none"> attributes <ul style="list-style-type: none"> MID RelatedMID D2001_SPID: D2001 Unique identifier that Identifies each supply point and the service provided D4006_EffectiveFrom: Details the date any data may be effective from D4007_DateOfEvidence: Identifies the date on which evidence to support a T34.0 is compiled. D4003_Comment: Generic text field for (short) comments and notes related to the transaction D4008_CryptographicHash: Will identify the compiled evidence and will serve to provide a fingerprint for that evidence so that any party at any time can confirm the contents of the contemporary version of the evidence. The hash algorithm used to populate this data item must be that specified in the associated D4009 Cryptographic Hash Algorithm. D4009_CryptographicHashAlgorithm: Name of the cryptographic hash algorithm used to derive the value of an associated D4008 Cryptographic Hash. | | | | | | | | | | | | | | | | | | |
|----------------------------|------------------------------------------------------------------------------------------------------------------------------------------------------------------------------------------------------------------------------------------------------------------------------------------------------------------------------------------------------------------------------------------------------------------------------------------------------------------------------------------------------------------------------------------------------------------------------------------------------------------------------------------------------------------------------------------------------------------------------------------------------------------------------------------------------------------------------------------------------------------------------------------------------------------------------------------------------------------------------------------------------------------------------------------------------------------------------------------------------------------------------------------------------------------------------|----------|---------|-------|------------|-------|------------|---------------------|-------------------------------|----------|--|--|--|----------------------------|-------------------------------|----------|--|--|--|
| <p>namespace</p> | <p>urn:bridgeall-com:cmaservice:data:v3</p> | | | | | | | | | | | | | | | | | | |
| <p>type</p> | <p>T034.0_VacSchemeApplication</p> | | | | | | | | | | | | | | | | | | |
| <p>properties</p> | <p>isRef 0 content complex</p> | | | | | | | | | | | | | | | | | | |
| <p>children</p> | <p>D2001_SPID D4006_EffectiveFrom D4007_DateOfEvidence D4003_Comment D4008_CryptographicHash D4009_CryptographicHashAlgorithm</p> | | | | | | | | | | | | | | | | | | |
| <p>attributes</p> | <table border="1"> <thead> <tr> <th>Name</th> <th>Type</th> <th>Use</th> <th>Default</th> <th>Fixed</th> <th>annotation</th> </tr> </thead> <tbody> <tr> <td>MID</td> <td>MessageIdType</td> <td>required</td> <td></td> <td></td> <td></td> </tr> <tr> <td>RelatedMID</td> <td>MessageIdType</td> <td>optional</td> <td></td> <td></td> <td></td> </tr> </tbody> </table> | Name | Type | Use | Default | Fixed | annotation | MID | MessageIdType | required | | | | RelatedMID | MessageIdType | optional | | | |
| Name | Type | Use | Default | Fixed | annotation | | | | | | | | | | | | | | |
| MID | MessageIdType | required | | | | | | | | | | | | | | | | | |
| RelatedMID | MessageIdType | optional | | | | | | | | | | | | | | | | | |
| <p>source</p> | <pre><xs:element name="T034.0_VacSchemeApplication" type="T034.0_VacSchemeApplication"/></pre> | | | | | | | | | | | | | | | | | | |

element **MessagesType/T034.4_VacSchemeApplicationConfirmationOrCancellations**

| | |
|------------|-------------------------------------------------------------------------------------------------------------------------------------------------------------------------------------------------------------------------------------------------------------------------------------------------------------------------------------------------------------------------------------------------------------------|
| diagram | |
| namespace | urn:bridgeall-com:cmaservice:data:v3 |
| properties | isRef 0 content complex |
| children | T034.4_VacSchemeApplicationConfirmationOrCancellation |
| source | <pre> <xs:element name="T034.4_VacSchemeApplicationConfirmationOrCancellations"> <xs:complexType> <xs:sequence maxOccurs="unbounded"> <xs:element name="T034.4_VacSchemeApplicationConfirmationOrCancellation" type="T034.4_VacSchemeApplicationConfirmationOrCancellation"/> </xs:sequence> </xs:complexType> </xs:element> </pre> |

element

MessageType/T034.4_VacSchemeApplicationConfirmationOrCancellations/T034.4_VacSchemeApplicationConfirmationOrCancellation

| <p>diagram</p> | | | | | | | | | | | | | | | | | | | |
|----------------------------|--------------------------------------------------------------------------------------------------------------------------------------------------------------------------------------------------------------------------------------------------------------------------------------------------------------------------------------------------------------------------------------------------------------------------------------------|----------|---------|-------|------------|-------|------------|---------------------|-------------------------------|----------|--|--|--|----------------------------|-------------------------------|----------|--|--|--|
| <p>namespace</p> | <p>urn:bridgeall-com:cmaservice:data:v3</p> | | | | | | | | | | | | | | | | | | |
| <p>type</p> | <p>T034.4_VacSchemeApplicationConfirmationOrCancellation</p> | | | | | | | | | | | | | | | | | | |
| <p>properties</p> | <p>isRef 0 content complex</p> | | | | | | | | | | | | | | | | | | |
| <p>children</p> | <p>D2001_SPID D4006_EffectiveFrom D4007_DateOfEvidence D2031_VacancyChangeFlag D2032_LPChallengedVacancyApplicationFlag D4003_Comment</p> | | | | | | | | | | | | | | | | | | |
| <p>attributes</p> | <table border="1"> <thead> <tr> <th>Name</th> <th>Type</th> <th>Use</th> <th>Default</th> <th>Fixed</th> <th>annotation</th> </tr> </thead> <tbody> <tr> <td>MID</td> <td>MessageIdType</td> <td>required</td> <td></td> <td></td> <td></td> </tr> <tr> <td>RelatedMID</td> <td>MessageIdType</td> <td>optional</td> <td></td> <td></td> <td></td> </tr> </tbody> </table> | Name | Type | Use | Default | Fixed | annotation | MID | MessageIdType | required | | | | RelatedMID | MessageIdType | optional | | | |
| Name | Type | Use | Default | Fixed | annotation | | | | | | | | | | | | | | |
| MID | MessageIdType | required | | | | | | | | | | | | | | | | | |
| RelatedMID | MessageIdType | optional | | | | | | | | | | | | | | | | | |
| <p>source</p> | <pre><xs:element name="T034.4_VacSchemeApplicationConfirmationOrCancellation" type="T034.4_VacSchemeApplicationConfirmationOrCancellation"/></pre> | | | | | | | | | | | | | | | | | | |

element **MessageType/T036.0_MeterNetworkAssociations**

| | |
|------------|-------------------------------------------------------------------------------------------------------------------------------------------------------------------------------------------------------------------------------------------------------------------------------------------------------------------------|
| diagram |  |
| namespace | urn:bridgeall-com:cmaservice:data:v3 |
| properties | isRef 0 content complex |
| children | T036.0_MeterNetworkAssociation |
| source | <pre> <xs:element name="T036.0_MeterNetworkAssociations"> <xs:complexType> <xs:sequence maxOccurs="unbounded"> <xs:element name="T036.0_MeterNetworkAssociation" type="MeterNetworkAssociationType"/> </xs:sequence> </xs:complexType> </xs:element> </pre> |

element **MessageType/T036.0_MeterNetworkAssociations/T036.0_MeterNetworkAssociation**

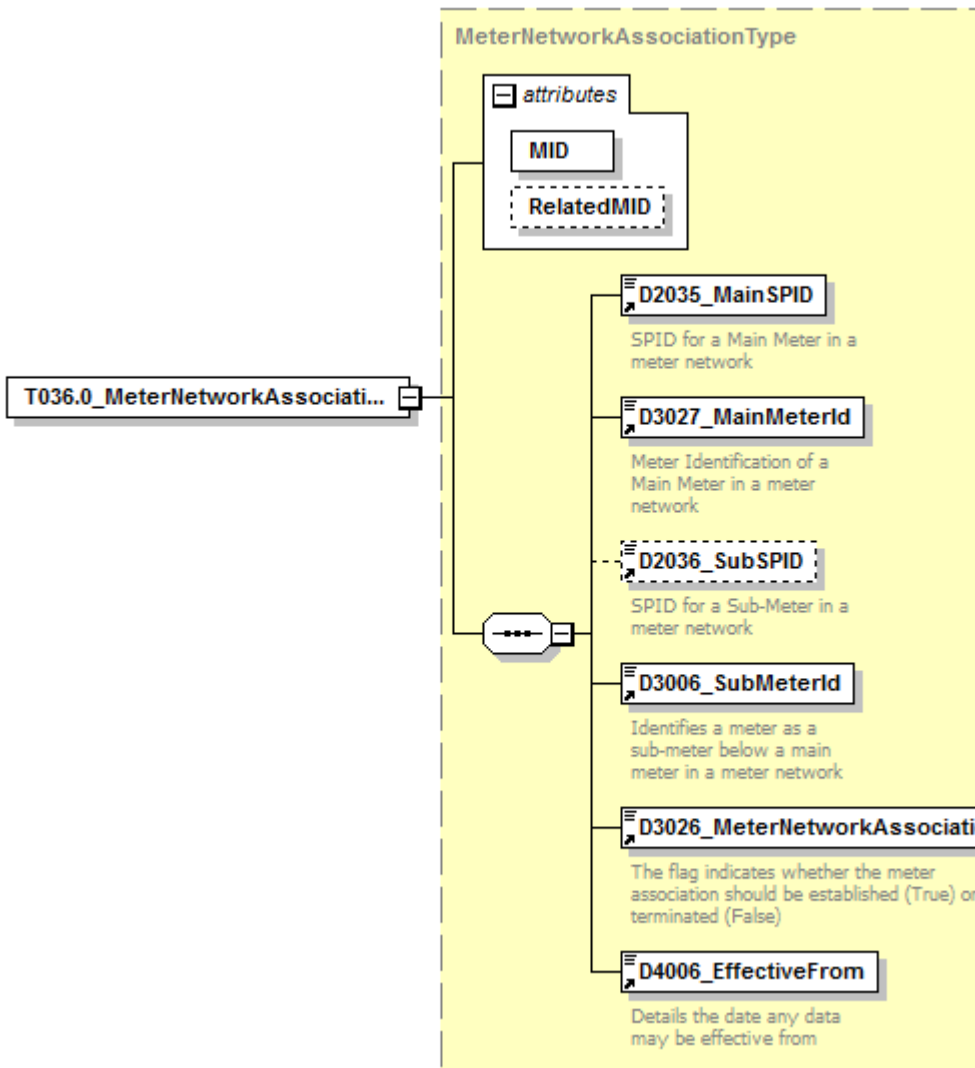
| | |
|---------|-------------------------------------------------------------------------------------|
| diagram |  |
|---------|-------------------------------------------------------------------------------------|

| | | | | | | |
|------------|-------------------------------------------------------------------------------------------------------------------------------------------------------------------------------------------------------------------|-------------------------------|----------|---------|-------|------------|
| namespace | urn:bridgeall-com:cmaservice:data:v3 | | | | | |
| type | MeterNetworkAssociationType | | | | | |
| properties | isRef | 0 | | | | |
| | content | complex | | | | |
| children | D2035 MainSPID D3027 MainMeterId D2036 SubSPID D3006 SubMeterId D3026 MeterNetworkAssociation D4006 EffectiveFrom | | | | | |
| attributes | Name | Type | Use | Default | Fixed | annotation |
| | MID | MessageldType | required | | | |
| | RelatedMID | MessageldType | optional | | | |
| source | <xs:element name="T036.0_MeterNetworkAssociation" type="MeterNetworkAssociationType"/> | | | | | |

complexType MeterAssociationType

| | | | | | | |
|------------|-----------------------------------------------------------------------------------------------------------------------------------------------------|--------------------------------------------------------------------------------------------------------------------------------------------------------|----------|---------|-------|------------|
| diagram | | | | | | |
| namespace | urn:bridgeall-com:cmaservice:data:v3 | | | | | |
| type | extension of MessageBody | | | | | |
| properties | base | MessageBody | | | | |
| children | D2001 SPID D6001 DPID D3001 MeterId D4006 EffectiveFrom D3024 MDVol | | | | | |
| used by | elements | MessagesType/T023.0 MeterAssociations/T023.0 MeterAssociation ResponseMessagesType/T023.1 MeterAssociationNotification | | | | |
| attributes | Name | Type | Use | Default | Fixed | annotation |
| | MID | MessageldType | required | | | |
| | RelatedMID | MessageldType | optional | | | |

| | |
|------------|-------------------------------------------------------------------------------------------------------------------------------------------------------------------------------------------------------------------------------------------------------------------------------------------------------------------------------------------------------------------------------------------------------------------------------------------------------------------------------------------------------------------------------------------------------------------------------------------------------------------------------------------------------------------|
| annotation | documentation |
| source | <pre> <xs:complexType name="MeterAssociationType"> <xs:annotation> <xs:documentation> </xs:documentation> </xs:annotation> <xs:complexContent> <xs:extension base="MessageBody"> <xs:sequence> <xs:element ref="D2001_SPID"/> <xs:element ref="D6001_DPID"/> <xs:element ref="D3001_MeterId"/> <xs:element ref="D4006_EffectiveFrom"/> <xs:element ref="D3024_MDVol"/> </xs:sequence> </xs:extension> </xs:complexContent> </xs:complexType> </pre> |

complexType **MeterDisAssociationType**

| diagram | | | | | | | | | | | | | |
|---------------------|------------------------------------------------------------------------------------------------------------------------------------------------------------------------------------------------------------------------------------------------------------------------------------------------------|----------|---------|-------|------------|-------|------------|---------------------|-------------------------------|----------|--|--|--|
| namespace | urn:bridgeall-com:cmaservice:data:v3 | | | | | | | | | | | | |
| type | extension of MessageBody | | | | | | | | | | | | |
| properties | base MessageBody | | | | | | | | | | | | |
| children | D2001_SPID D6001_DPID D3001_MeterId D4006_EffectiveFrom | | | | | | | | | | | | |
| used by | elements MessagesType/T024.0 MeterDisAssociations/T024.0 MeterDisAssociation ResponseMessagesType/T024.1 MeterDisAssociationNotification | | | | | | | | | | | | |
| attributes | <table border="1"> <thead> <tr> <th>Name</th> <th>Type</th> <th>Use</th> <th>Default</th> <th>Fixed</th> <th>annotation</th> </tr> </thead> <tbody> <tr> <td>MID</td> <td>MessageIdType</td> <td>required</td> <td></td> <td></td> <td></td> </tr> </tbody> </table> | Name | Type | Use | Default | Fixed | annotation | MID | MessageIdType | required | | | |
| Name | Type | Use | Default | Fixed | annotation | | | | | | | | |
| MID | MessageIdType | required | | | | | | | | | | | |

| | |
|------------|----------------------------------------------------------------------------------------------------------------------------------------------------------------------------------------------------------------------------------------------------------------------------------------------------------------------------------------------------------------------------------------------------------------------------------------------------------------------------------------------------------------------------------------------------------------------------------------------------------------------|
| | RelatedMID MessageIdType optional |
| annotation | documentation |
| source | <pre> <xs:complexType name="MeterDisAssociationType"> <xs:annotation> <xs:documentation> </xs:documentation> </xs:annotation> <xs:complexContent> <xs:extension base="MessageBody"> <xs:sequence> <xs:element ref="D2001_SPID"/> <xs:element ref="D6001_DPID"/> <xs:element ref="D3001_MeterId"/> <xs:element ref="D4006_EffectiveFrom"/> </xs:sequence> </xs:extension> </xs:complexContent> </xs:complexType> </pre> |

complexType **MeterNetworkAssociationType**

| <p>diagram</p> | | | | | | | | | | | | | | | | | | | |
|----------------------------|--------------------------------------------------------------------------------------------------------------------------------------------------------------------------------------------------------------------------------------------------------------------------------------------------------------------------------------------------------------------------------------------------------------------------------------------|----------|---------|-------|------------|-------|------------|---------------------|-------------------------------|----------|--|--|--|----------------------------|-------------------------------|----------|--|--|--|
| <p>namespace</p> | <p>urn:bridgeall-com:cmaservice:data:v3</p> | | | | | | | | | | | | | | | | | | |
| <p>type</p> | <p>extension of MessageBody</p> | | | | | | | | | | | | | | | | | | |
| <p>properties</p> | <p>base MessageBody</p> | | | | | | | | | | | | | | | | | | |
| <p>children</p> | <p>D2035_MainSPID D3027_MainMeterId D2036_SubSPID D3006_SubMeterId D3026_MeterNetworkAssociation D4006_EffectiveFrom</p> | | | | | | | | | | | | | | | | | | |
| <p>used by</p> | <p>elements MessagesType/T036.0_MeterNetworkAssociations/T036.0_MeterNetworkAssociationResponseMessagesType/T036.1_MeterNetworkAssociationNotification</p> | | | | | | | | | | | | | | | | | | |
| <p>attributes</p> | <table border="1"> <thead> <tr> <th>Name</th> <th>Type</th> <th>Use</th> <th>Default</th> <th>Fixed</th> <th>annotation</th> </tr> </thead> <tbody> <tr> <td>MID</td> <td>MessageIdType</td> <td>required</td> <td></td> <td></td> <td></td> </tr> <tr> <td>RelatedMID</td> <td>MessageIdType</td> <td>optional</td> <td></td> <td></td> <td></td> </tr> </tbody> </table> | Name | Type | Use | Default | Fixed | annotation | MID | MessageIdType | required | | | | RelatedMID | MessageIdType | optional | | | |
| Name | Type | Use | Default | Fixed | annotation | | | | | | | | | | | | | | |
| MID | MessageIdType | required | | | | | | | | | | | | | | | | | |
| RelatedMID | MessageIdType | optional | | | | | | | | | | | | | | | | | |
| <p>annotation</p> | <p>documentation</p> | | | | | | | | | | | | | | | | | | |
| <p>source</p> | <pre><xs:complexType name="MeterNetworkAssociationType"> <xs:annotation> <xs:documentation> </xs:documentation> </xs:annotation> <xs:complexContent> <xs:extension base="MessageBody"></pre> | | | | | | | | | | | | | | | | | | |

```
<xs:sequence>
  <xs:element ref="D2035_MainSPID"/>
  <xs:element ref="D3027_MainMeterId"/>
  <xs:element ref="D2036_SubSPID" minOccurs="0"/>
  <xs:element ref="D3006_SubMeterId"/>
  <xs:element ref="D3026_MeterNetworkAssociation"/>
  <xs:element ref="D4006_EffectiveFrom"/>
</xs:sequence>
</xs:extension>
</xs:complexContent>
</xs:complexType>
```

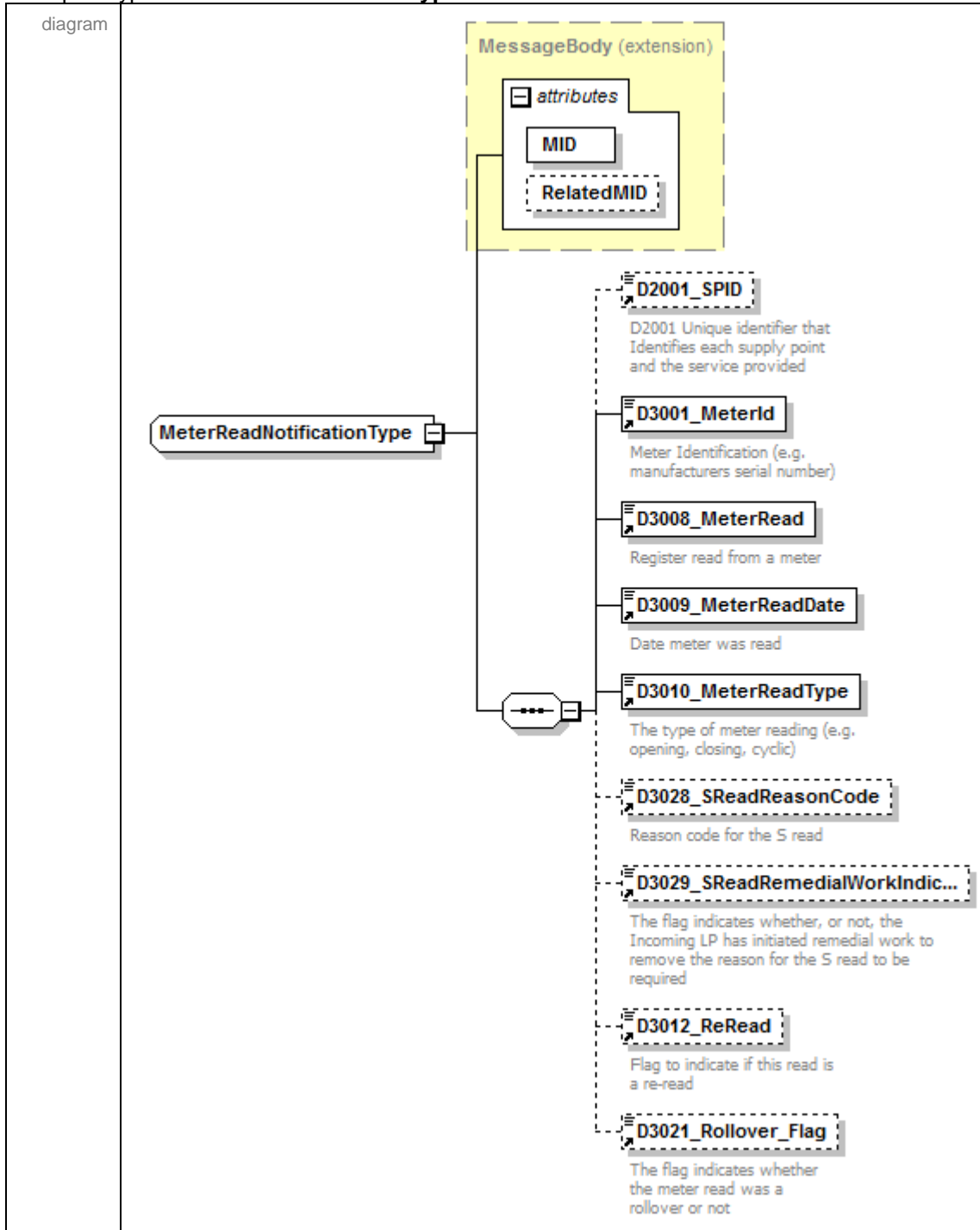

complexType **MeterReadNotificationType**



| | | | | | | |
|------------|--------------------------------------------------------------------------------------------------------------------------------------------------------------------------------------------------------------------------------------------------------------------------------------------------------------------------|----------------------------------------------------------------------------------------------------------------------------------------|----------|---------|-------|------------|
| namespace | urn:bridgeall-com:cmaservice:data:v3 | | | | | |
| type | extension of MessageBody | | | | | |
| properties | base MessageBody | | | | | |
| children | D2001_SPID D3001_MeterId D3008_MeterRead D3009_MeterReadDate D3010_MeterReadType D3028_SReadReasonCode D3029_SReadRemedialWorkIndicator D3012_ReRead D3021_Rollover_Flag | | | | | |
| used by | elements | ResponseMessagesType/T005.2_MeterReadNotification ResponseMessagesType/T005.3_MeterReadNotification | | | | |
| attributes | Name | Type | Use | Default | Fixed | annotation |
| | MID | MessageIdType | required | | | |

| | |
|------------|-------------------------------------------------------------------------------------------------------------------------------------------------------------------------------------------------------------------------------------------------------------------------------------------------------------------------------------------------------------------------------------------------------------------------------------------------------------------------------------------------------------------------------------------------------------------------------------------------------------------------------------------------------------------------------------------------------------------------------------------------------------------------------------------------------------------------------------------------------------------------------------------------------------------------------------------------------------------|
| | RelatedMID MessageIdType optional |
| annotation | documentation |
| source | <pre> <xs:complexType name="MeterReadNotificationType"> <xs:annotation> <xs:documentation> </xs:documentation> </xs:annotation> <xs:complexContent> <xs:extension base="MessageBody"> <xs:sequence> <xs:element ref="D2001_SPID" minOccurs="0"/> <xs:element ref="D3001_MeterId"/> <xs:element ref="D3008_MeterRead"/> <xs:element ref="D3009_MeterReadDate"/> <xs:element ref="D3010_MeterReadType"/> <xs:element ref="D3028_SReadReasonCode" minOccurs="0"/> <xs:element ref="D3029_SReadRemedialWorkIndicator" minOccurs="0"/> <xs:element ref="D3012_ReRead" minOccurs="0"/> <xs:element ref="D3021_Rollover_Flag" minOccurs="0"/> </xs:sequence> </xs:extension> </xs:complexContent> </xs:complexType> </pre> |

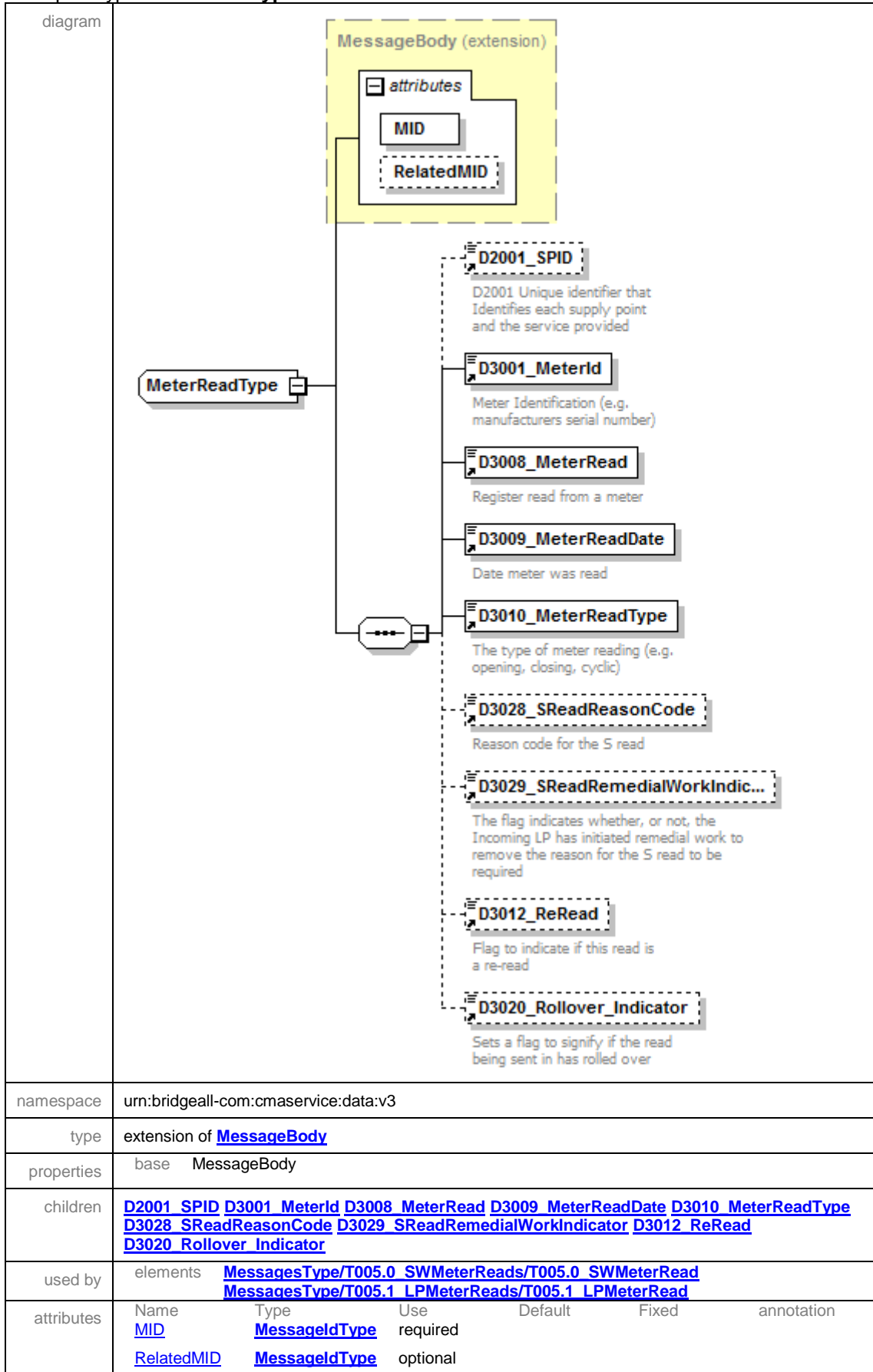
complexType **MeterReadType**



| | |
|------------|--------------------------------------------------------------------------------------------------------------------------------------------------------------------------------------------------------------------------------------------------------------------------------------------------------------------------------------------------------------------------------------------------------------------------------------------------------------------------------------------------------------------------------------------------------------------------------------------------------------------------------------------------------------------------------------------------------------------------------------------------------------------------------------------------------------------------------------------------------------------------------------------------------------------------------------------------------------------------------------------|
| annotation | documentation |
| source | <pre> <xs:complexType name="MeterReadType"> <xs:annotation> <xs:documentation> </xs:documentation> </xs:annotation> <xs:complexContent> <xs:extension base="MessageBody"> <xs:sequence> <xs:element ref="D2001_SPID" minOccurs="0"/> <xs:element ref="D3001_MeterId"/> <xs:element ref="D3008_MeterRead"/> <xs:element ref="D3009_MeterReadDate"/> <xs:element ref="D3010_MeterReadType"/> <xs:element ref="D3028_SReadReasonCode" minOccurs="0"/> <xs:element ref="D3029_SReadRemedialWorkIndicator" minOccurs="0"/> <xs:element ref="D3012_ReRead" minOccurs="0"/> <xs:element ref="D3020_Rollover_Indicator" minOccurs="0"/> </xs:sequence> </xs:extension> </xs:complexContent> </xs:complexType> </pre> |

complexType MeterSWAPDetailsNotificationType

| | |
|-----------|-------------------------------------------------------------------------------------------------------------------------------------------------------------------------------------------------------------------------------------------------------------------------------------------------|
| diagram | |
| namespace | urn:bridgeall-com:cmaservice:data:v3 |
| children | D3001_MeterId D3008_MeterRead D3009_MeterReadDate D3010_MeterReadType D3021_Rollover_Flag |
| used by | elements MeterSwapNotificationType/NewMeter MeterSwapNotificationType/OldMeter |
| source | <pre> <xs:complexType name="MeterSWAPDetailsNotificationType"> <xs:sequence> <xs:element ref="D3001_MeterId"/> <xs:element ref="D3008_MeterRead"/> <xs:element ref="D3009_MeterReadDate"/> <xs:element ref="D3010_MeterReadType"/> </pre> |

| | |
|--|---------------------------------------------------------------------------------------------------------------------|
| | <pre><xs:element ref="D3021_Rollover_Flag" minOccurs="0"/> </xs:sequence> </xs:complexType></pre> |
|--|---------------------------------------------------------------------------------------------------------------------|

complexType **MeterSWAPDetailsType**

| | |
|-----------|-------------------------------------------------------------------------------------------------------------------------------------------------------------------------------------------------------------------------------------------------------------------------------------------------------------------------------------------------------------------------------------------------------|
| diagram | |
| namespace | urn:bridgeall-com:cmaservice:data:v3 |
| children | D3001_MeterId D3008_MeterRead D3009_MeterReadDate D3010_MeterReadType D3020_Rollover_Indicator |
| used by | elements MeterSwapType/NewMeter MeterSwapType/OldMeter |
| source | <pre><xs:complexType name="MeterSWAPDetailsType"> <xs:sequence> <xs:element ref="D3001_MeterId"/> <xs:element ref="D3008_MeterRead"/> <xs:element ref="D3009_MeterReadDate"/> <xs:element ref="D3010_MeterReadType"/> <xs:element ref="D3020_Rollover_Indicator" minOccurs="0"/> </xs:sequence> </xs:complexType></pre> |

complexType **MeterSwapNotificationType**

| diagram | | | | | | | | | | | | | | | | | | | |
|----------------------------|----------------------------------------------------------------------------------------------------------------------------------------------------------------------------------------------------------------------------------------------------------------------------------------------------------------------------------------------------------------------------------------------------------------------------------------------------------------------------------------------------------------------------------------------------------------------------------------------------------------------------------------------------------------------------------------------------------|----------|---------|-------|------------|-------|------------|---------------------|-------------------------------|----------|--|--|--|----------------------------|-------------------------------|----------|--|--|--|
| namespace | urn:bridgeall-com:cmaservice:data:v3 | | | | | | | | | | | | | | | | | | |
| type | extension of MessageBody | | | | | | | | | | | | | | | | | | |
| properties | base MessageBody | | | | | | | | | | | | | | | | | | |
| children | D2001_SPID NewMeter OldMeter D3012_ReRead | | | | | | | | | | | | | | | | | | |
| used by | element ResponseMessagesType/T017.1 MeterSwapNotification | | | | | | | | | | | | | | | | | | |
| attributes | <table border="1"> <thead> <tr> <th>Name</th> <th>Type</th> <th>Use</th> <th>Default</th> <th>Fixed</th> <th>annotation</th> </tr> </thead> <tbody> <tr> <td>MID</td> <td>MessageIdType</td> <td>required</td> <td></td> <td></td> <td></td> </tr> <tr> <td>RelatedMID</td> <td>MessageIdType</td> <td>optional</td> <td></td> <td></td> <td></td> </tr> </tbody> </table> | Name | Type | Use | Default | Fixed | annotation | MID | MessageIdType | required | | | | RelatedMID | MessageIdType | optional | | | |
| Name | Type | Use | Default | Fixed | annotation | | | | | | | | | | | | | | |
| MID | MessageIdType | required | | | | | | | | | | | | | | | | | |
| RelatedMID | MessageIdType | optional | | | | | | | | | | | | | | | | | |
| annotation | documentation | | | | | | | | | | | | | | | | | | |
| source | <pre> <xs:complexType name="MeterSwapNotificationType"> <xs:annotation> <xs:documentation> </xs:documentation> </xs:annotation> <xs:complexContent> <xs:extension base="MessageBody"> <xs:sequence> <xs:element ref="D2001_SPID" minOccurs="0"/> <xs:element name="NewMeter" type="MeterSWAPDetailsNotificationType"/> <xs:element name="OldMeter" type="MeterSWAPDetailsNotificationType"/> <xs:element ref="D3012_ReRead"/> </xs:sequence> </xs:extension> </xs:complexContent> </xs:complexType> </pre> | | | | | | | | | | | | | | | | | | |

element **MeterSwapNotificationType/NewMeter**

| | |
|-------------------|----------------------------------------------------------------------------------------------------------------------------------------------------------------------------------------------------------------------------------------------------------------------------------------------------------------------------------------------------------------------------------------------------------------------------------------------------------------------------------------------------------------------------------------------------------------------------------------------------------------------------------------------------------------|
| <p>diagram</p> | <p>The diagram illustrates the structure of the NewMeter element. It is a container for the MeterSWAPDetailsNotificationType complex type. The complex type contains five elements:</p> <ul style="list-style-type: none"> D3001_MeterId: Meter Identification (e.g. manufacturers serial number) D3008_MeterRead: Register read from a meter D3009_MeterReadDate: Date meter was read D3010_MeterReadType: The type of meter reading (e.g. opening, closing, cyclic) D3021_Rollover_Flag: The flag indicates whether the meter read was a rollover or not |
| <p>namespace</p> | <p>urn:bridgeall-com:cmaservice:data:v3</p> |
| <p>type</p> | <p>MeterSWAPDetailsNotificationType</p> |
| <p>properties</p> | <p>isRef 0 content complex</p> |
| <p>children</p> | <p>D3001_MeterId D3008_MeterRead D3009_MeterReadDate D3010_MeterReadType D3021_Rollover_Flag</p> |
| <p>source</p> | <p><code><xs:element name="NewMeter" type="MeterSWAPDetailsNotificationType"/></code></p> |

element **MeterSwapNotificationType/OldMeter**

| | |
|----------------|----------------------------------------------------------------------------------------------------------------------------------------------------------------------------------------------------------------------------------------------------------------------------------------------------------------------------------------------------------------------------------------------------------------------------------------------------------------------------------------------------------------------------------------------------------------------------------------------------------------------------------------------------------------|
| <p>diagram</p> | <p>The diagram illustrates the structure of the OldMeter element. It is a container for the MeterSWAPDetailsNotificationType complex type. The complex type contains five elements:</p> <ul style="list-style-type: none"> D3001_MeterId: Meter Identification (e.g. manufacturers serial number) D3008_MeterRead: Register read from a meter D3009_MeterReadDate: Date meter was read D3010_MeterReadType: The type of meter reading (e.g. opening, closing, cyclic) D3021_Rollover_Flag: The flag indicates whether the meter read was a rollover or not |
|----------------|----------------------------------------------------------------------------------------------------------------------------------------------------------------------------------------------------------------------------------------------------------------------------------------------------------------------------------------------------------------------------------------------------------------------------------------------------------------------------------------------------------------------------------------------------------------------------------------------------------------------------------------------------------------|

| | |
|------------|------------------------------------------------------------------------------------------------------------------------------------------------------------------------------|
| namespace | urn:bridgeall-com:cmaservice:data:v3 |
| type | MeterSWAPDetailsNotificationType |
| properties | isRef 0 content complex |
| children | D3001_MeterId D3008_MeterRead D3009_MeterReadDate D3010_MeterReadType D3021_Rollover_Flag |
| source | <xs:element name="OldMeter" type="MeterSWAPDetailsNotificationType"/> |

complexType MeterSwapType

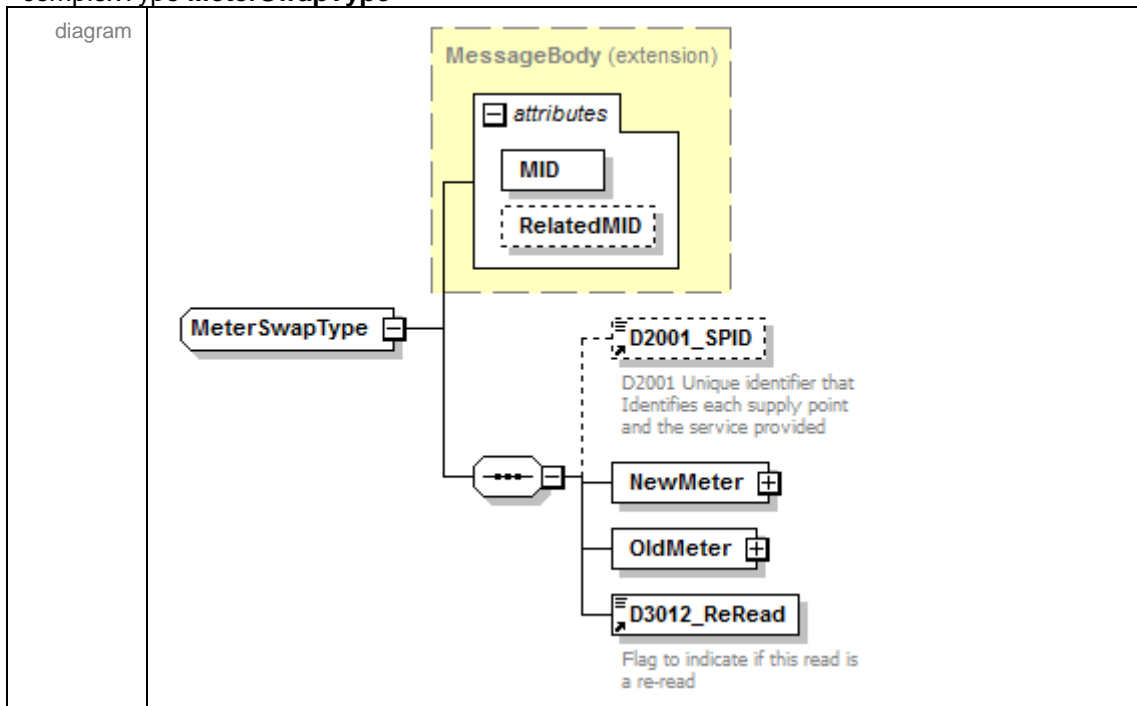

| namespace | urn:bridgeall-com:cmaservice:data:v3 | | | | | | | | | | | | | | | | | | |
|----------------------------|-------------------------------------------------------------------------------------------------------------------------------------------------------------------------------------------------------------------------------------------------------------------------------------------------------------------------------------------------------------------------------------------------------------------------------------------------------------------------------------------------------------------------------------------|----------|---------|-------|------------|-------|------------|---------------------|-------------------------------|----------|--|--|--|----------------------------|-------------------------------|----------|--|--|--|
| type | extension of MessageBody | | | | | | | | | | | | | | | | | | |
| properties | base MessageBody | | | | | | | | | | | | | | | | | | |
| children | D2001_SPID NewMeter OldMeter D3012_ReRead | | | | | | | | | | | | | | | | | | |
| used by | element MessagesType/T017.0_MeterSwaps/T017.0_MeterSwap | | | | | | | | | | | | | | | | | | |
| attributes | <table border="1"> <thead> <tr> <th>Name</th> <th>Type</th> <th>Use</th> <th>Default</th> <th>Fixed</th> <th>annotation</th> </tr> </thead> <tbody> <tr> <td>MID</td> <td>MessageIdType</td> <td>required</td> <td></td> <td></td> <td></td> </tr> <tr> <td>RelatedMID</td> <td>MessageIdType</td> <td>optional</td> <td></td> <td></td> <td></td> </tr> </tbody> </table> | Name | Type | Use | Default | Fixed | annotation | MID | MessageIdType | required | | | | RelatedMID | MessageIdType | optional | | | |
| Name | Type | Use | Default | Fixed | annotation | | | | | | | | | | | | | | |
| MID | MessageIdType | required | | | | | | | | | | | | | | | | | |
| RelatedMID | MessageIdType | optional | | | | | | | | | | | | | | | | | |
| annotation | documentation | | | | | | | | | | | | | | | | | | |
| source | <pre> <xs:complexType name="MeterSwapType"> <xs:annotation> <xs:documentation> </xs:documentation> </xs:annotation> <xs:complexContent> <xs:extension base="MessageBody"> <xs:sequence> <xs:element ref="D2001_SPID" minOccurs="0"/> <xs:element name="NewMeter" type="MeterSWAPDetailsType"/> </xs:sequence> </xs:extension> </xs:complexContent> </xs:complexType> </pre> | | | | | | | | | | | | | | | | | | |

| | |
|--|-------------------------------------------------------------------------------------------------------------------------------------------------------------------------------------------------------------------|
| | <pre> <xs:element name="OldMeter" type="MeterSWAPDetailsType"/> <xs:element ref="D3012_ReRead"/> </xs:sequence> </xs:extension> </xs:complexContent> </xs:complexType> </pre> |
|--|-------------------------------------------------------------------------------------------------------------------------------------------------------------------------------------------------------------------|

element **MeterSwapType/NewMeter**

| | |
|------------|------------------------------------------------------------------------------------------------------------------------------------------------------------------------------------------------------------------------------------------------------------------------------------------------------------------------------------------------------------------------------------------------------------------------------------------------------------------------------------------------------------------------------------------------------------------------------------------------------------------------------------------------------------------------------------------------------------------------------------|
| diagram | <p>The diagram illustrates the structure of the NewMeter element. It is a complex type that contains a MeterSWAPDetailsType element. The MeterSWAPDetailsType element is shown in a yellow dashed box and contains the following elements:</p> <ul style="list-style-type: none"> D3001_MeterId: Meter Identification (e.g. manufacturers serial number) D3008_MeterRead: Register read from a meter D3009_MeterReadDate: Date meter was read D3010_MeterReadType: The type of meter reading (e.g. opening, closing, cyclic) D3020_Rollover_Indicator: Sets a flag to signify if the read being sent in has rolled over |
| namespace | urn:bridgeall-com:cmaservice:data:v3 |
| type | MeterSWAPDetailsType |
| properties | isRef 0 content complex |
| children | D3001_MeterId D3008_MeterRead D3009_MeterReadDate D3010_MeterReadType D3020_Rollover_Indicator |
| source | <pre><xs:element name="NewMeter" type="MeterSWAPDetailsType"/></pre> |

element **MeterSwapType/OldMeter**

| | |
|-------------------|-------------------------------------------------------------------------------------------------------------------------------------------------------------------------------------------------------------------------------------------------------------------------------------------------------------------------------------------------------------------------------------------------------------------------------------------------------------------------------------------------------------------------------------------------------------------------------------------------------------------------------------------------------------------------------|
| <p>diagram</p> | <p>The diagram illustrates the structure of the OldMeter element. It is a container for the MeterSWAPDetailsType complex type. The MeterSWAPDetailsType contains five child elements:</p> <ul style="list-style-type: none"> D3001_MeterId: Meter Identification (e.g. manufacturers serial number) D3008_MeterRead: Register read from a meter D3009_MeterReadDate: Date meter was read D3010_MeterReadType: The type of meter reading (e.g. opening, closing, cyclic) D3020_Rollover_Indicator: Sets a flag to signify if the read being sent in has rolled over |
| <p>namespace</p> | <p>urn:bridgeall-com:cmaservice:data:v3</p> |
| <p>type</p> | <p>MeterSWAPDetailsType</p> |
| <p>properties</p> | <p>isRef 0 content complex</p> |
| <p>children</p> | <p>D3001_MeterId D3008_MeterRead D3009_MeterReadDate D3010_MeterReadType D3020_Rollover_Indicator</p> |
| <p>source</p> | <pre><xs:element name="OldMeter" type="MeterSWAPDetailsType"/></pre> |

complexType **MeterUpdateNotificationType**

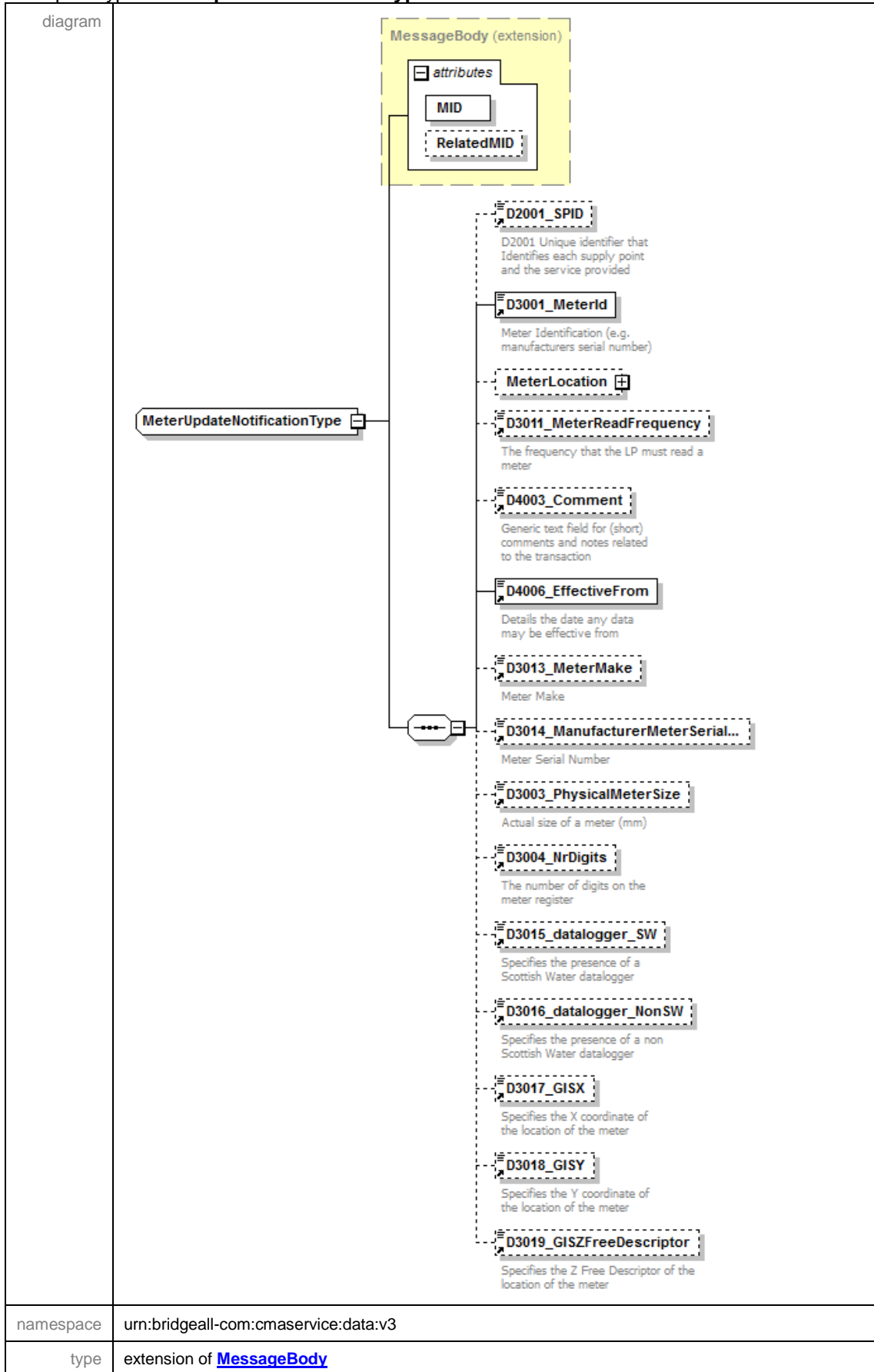

| properties | base MessageBody | | | | | | | | | | | | | | | | | | |
|----------------------------|---------------------------------------------------------------------------------------------------------------------------------------------------------------------------------------------------------------------------------------------------------------------------------------------------------------------------------------------------------------------------------------------------------------------------------------------------------------------------------------------------------------------------------------------------------------------------------------------------------------------------------------------------------------------------------------------------------------------------------------------------------------------------------------------------------------------------------------------------------------------------------------------------------------------------------------------------------------------------------------------------------------------------------------------------------------------------------------------------------------------------------------------------------------------------------------------------------------------------------------------------------------------------------------------------------------------------------------------------------------------------------------------------------------------------------------------------------------------------|----------|---------|-------|------------|-------|------------|---------------------|-------------------------------|----------|--|--|--|----------------------------|-------------------------------|----------|--|--|--|
| children | D2001_SPID D3001_MeterId MeterLocation D3011_MeterReadFrequency D4003_Comment D4006_EffectiveFrom D3013_MeterMake D3014_ManufacturerMeterSerialNr D3003_PhysicalMeterSize D3004_NrDigits D3015_datalogger_SW D3016_datalogger_NonSW D3017_GISX D3018_GISY D3019_GISZFreeDescriptor | | | | | | | | | | | | | | | | | | |
| used by | element ResponseMessagesType/T013.1_MeterUpdate | | | | | | | | | | | | | | | | | | |
| attributes | <table border="1"> <thead> <tr> <th>Name</th> <th>Type</th> <th>Use</th> <th>Default</th> <th>Fixed</th> <th>annotation</th> </tr> </thead> <tbody> <tr> <td>MID</td> <td>MessageldType</td> <td>required</td> <td></td> <td></td> <td></td> </tr> <tr> <td>RelatedMID</td> <td>MessageldType</td> <td>optional</td> <td></td> <td></td> <td></td> </tr> </tbody> </table> | Name | Type | Use | Default | Fixed | annotation | MID | MessageldType | required | | | | RelatedMID | MessageldType | optional | | | |
| Name | Type | Use | Default | Fixed | annotation | | | | | | | | | | | | | | |
| MID | MessageldType | required | | | | | | | | | | | | | | | | | |
| RelatedMID | MessageldType | optional | | | | | | | | | | | | | | | | | |
| annotation | documentation | | | | | | | | | | | | | | | | | | |
| source | <pre> <xs:complexType name="MeterUpdateNotificationType"> <xs:annotation> <xs:documentation> </xs:documentation> </xs:annotation> <xs:complexContent> <xs:extension base="MessageBody"> <xs:sequence> <xs:element ref="D2001_SPID" minOccurs="0"/> <xs:element ref="D3001_MeterId"/> <xs:element name="MeterLocation" type="AddressType" minOccurs="0"/> <xs:element ref="D3011_MeterReadFrequency" minOccurs="0"/> <xs:element ref="D4003_Comment" minOccurs="0"/> <xs:element ref="D4006_EffectiveFrom"/> <xs:element ref="D3013_MeterMake" minOccurs="0"/> <xs:element ref="D3014_ManufacturerMeterSerialNr" minOccurs="0"/> <xs:element ref="D3003_PhysicalMeterSize" minOccurs="0"/> <xs:element ref="D3004_NrDigits" minOccurs="0"/> <xs:element ref="D3015_datalogger_SW" minOccurs="0"/> <xs:element ref="D3016_datalogger_NonSW" minOccurs="0"/> <xs:element ref="D3017_GISX" minOccurs="0"/> <xs:element ref="D3018_GISY" minOccurs="0"/> <xs:element ref="D3019_GISZFreeDescriptor" minOccurs="0"/> </xs:sequence> </xs:extension> </xs:complexContent> </xs:complexType> </pre> | | | | | | | | | | | | | | | | | | |

element **MeterUpdateNotificationType/MeterLocation**

| | |
|-------------------|--------------------------------------------------------------------------------------------------------------------------------------------------------------------------------------------------------------------------------------------------------------------------------------------------------------------------------------------------------------------------------------------------------------------------------------------------------------------------------------------------------------------------------------|
| <p>diagram</p> | |
| <p>namespace</p> | <p>urn:bridgeall-com:cmaservice:data:v3</p> |
| <p>type</p> | <p>AddressType</p> |
| <p>properties</p> | <p>isRef 0 minOcc 0 maxOcc 1 content complex</p> |
| <p>children</p> | <p>D5001_FreeDescriptor D5002_SubBuildingName D5003_BuildingName D5004_BuildingNumber D5005_DependentThoroughfareName D5006_DependentThoroughfareDescriptor D5007_ThoroughfareName D5008_ThoroughfareDescriptor D5009_DoubleDependentLocality D5010_DependentLocality D5011_PostTown D5012_County D5013_Postcode</p> |
| <p>source</p> | <p><xs:element name="MeterLocation" type="AddressType" minOccurs="0"/></p> |

complexType **MeterUpdateType**

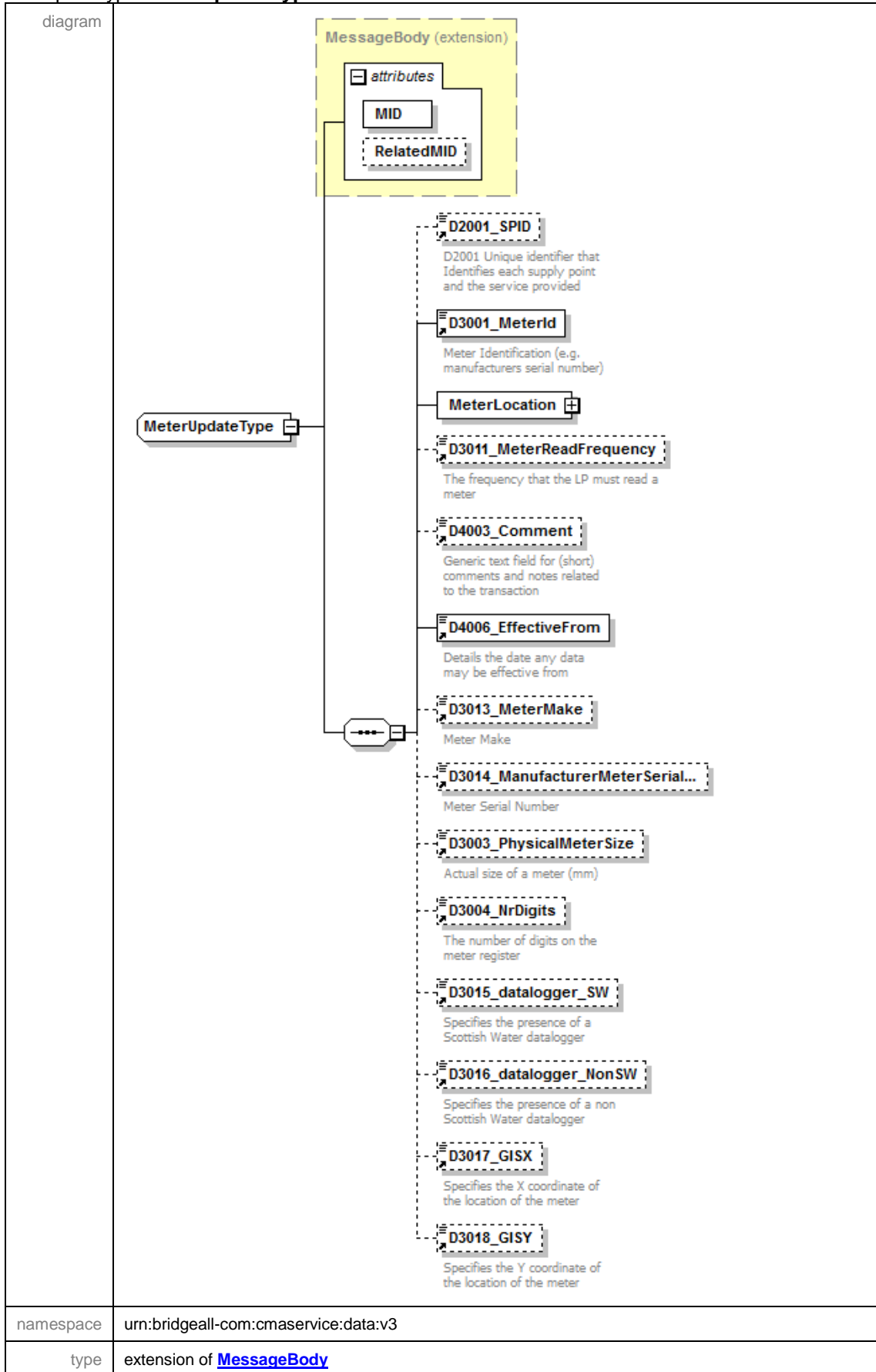

| properties | base MessageBody | | | | | | | | | | | | | | | | | | |
|----------------------------|----------------------------------------------------------------------------------------------------------------------------------------------------------------------------------------------------------------------------------------------------------------------------------------------------------------------------------------------------------------------------------------------------------------------------------------------------------------------------------------------------------------------------------------------------------------------------------------------------------------------------------------------------------------------------------------------------------------------------------------------------------------------------------------------------------------------------------------------------------------------------------------------------------------------------------------------------------------------------------------------------------------------------------------------------------------------------------------------------------------------------------------------------------------------------------------------------------------------------------------------------------------------------------------------------------------------------------------------------------------------|----------|---------|-------|------------|-------|------------|---------------------|-------------------------------|----------|--|--|--|----------------------------|-------------------------------|----------|--|--|--|
| children | D2001_SPID D3001_MeterId MeterLocation D3011_MeterReadFrequency D4003_Comment D4006_EffectiveFrom D3013_MeterMake D3014_ManufacturerMeterSerialNr D3003_PhysicalMeterSize D3004_NrDigits D3015_datalogger_SW D3016_datalogger_NonSW D3017_GISX D3018_GISY | | | | | | | | | | | | | | | | | | |
| used by | element MessagesType/T013.0_MeterUpdates/T013.0_MeterUpdate | | | | | | | | | | | | | | | | | | |
| attributes | <table border="1"> <thead> <tr> <th>Name</th> <th>Type</th> <th>Use</th> <th>Default</th> <th>Fixed</th> <th>annotation</th> </tr> </thead> <tbody> <tr> <td>MID</td> <td>MessageIdType</td> <td>required</td> <td></td> <td></td> <td></td> </tr> <tr> <td>RelatedMID</td> <td>MessageIdType</td> <td>optional</td> <td></td> <td></td> <td></td> </tr> </tbody> </table> | Name | Type | Use | Default | Fixed | annotation | MID | MessageIdType | required | | | | RelatedMID | MessageIdType | optional | | | |
| Name | Type | Use | Default | Fixed | annotation | | | | | | | | | | | | | | |
| MID | MessageIdType | required | | | | | | | | | | | | | | | | | |
| RelatedMID | MessageIdType | optional | | | | | | | | | | | | | | | | | |
| annotation | documentation | | | | | | | | | | | | | | | | | | |
| source | <pre> <xs:complexType name="MeterUpdateType"> <xs:annotation> <xs:documentation> </xs:documentation> </xs:annotation> <xs:complexContent> <xs:extension base="MessageBody"> <xs:sequence> <xs:element ref="D2001_SPID" minOccurs="0"/> <xs:element ref="D3001_MeterId"/> <xs:element name="MeterLocation" type="AddressType"/> <xs:element ref="D3011_MeterReadFrequency" minOccurs="0"/> <xs:element ref="D4003_Comment" minOccurs="0"/> <xs:element ref="D4006_EffectiveFrom"/> <xs:element ref="D3013_MeterMake" minOccurs="0"/> <xs:element ref="D3014_ManufacturerMeterSerialNr" minOccurs="0"/> <xs:element ref="D3003_PhysicalMeterSize" minOccurs="0"/> <xs:element ref="D3004_NrDigits" minOccurs="0"/> <xs:element ref="D3015_datalogger_SW" minOccurs="0"/> <xs:element ref="D3016_datalogger_NonSW" minOccurs="0"/> <xs:element ref="D3017_GISX" minOccurs="0"/> <xs:element ref="D3018_GISY" minOccurs="0"/> </xs:sequence> </xs:extension> </xs:complexContent> </xs:complexType> </pre> | | | | | | | | | | | | | | | | | | |

element **MeterUpdateType/MeterLocation**

| | |
|-------------------|--------------------------------------------------------------------------------------------------------------------------------------------------------------------------------------------------------------------------------------------------------------------------------------------------------------------------------------------------------------------------------------------------------------------------------------------------------------------------------------------------------------------------------------|
| <p>diagram</p> | |
| <p>namespace</p> | <p>urn:bridgeall-com:cmaservice:data:v3</p> |
| <p>type</p> | <p>AddressType</p> |
| <p>properties</p> | <p>isRef 0 content complex</p> |
| <p>children</p> | <p>D5001_FreeDescriptor D5002_SubBuildingName D5003_BuildingName D5004_BuildingNumber D5005_DependentThoroughfareName D5006_DependentThoroughfareDescriptor D5007_ThoroughfareName D5008_ThoroughfareDescriptor D5009_DoubleDependentLocality D5010_DependentLocality D5011_PostTown D5012_County D5013_Postcode</p> |
| <p>source</p> | <p><xs:element name="MeterLocation" type="AddressType"/></p> |

complexType **NewLPSPIDNotificationType**

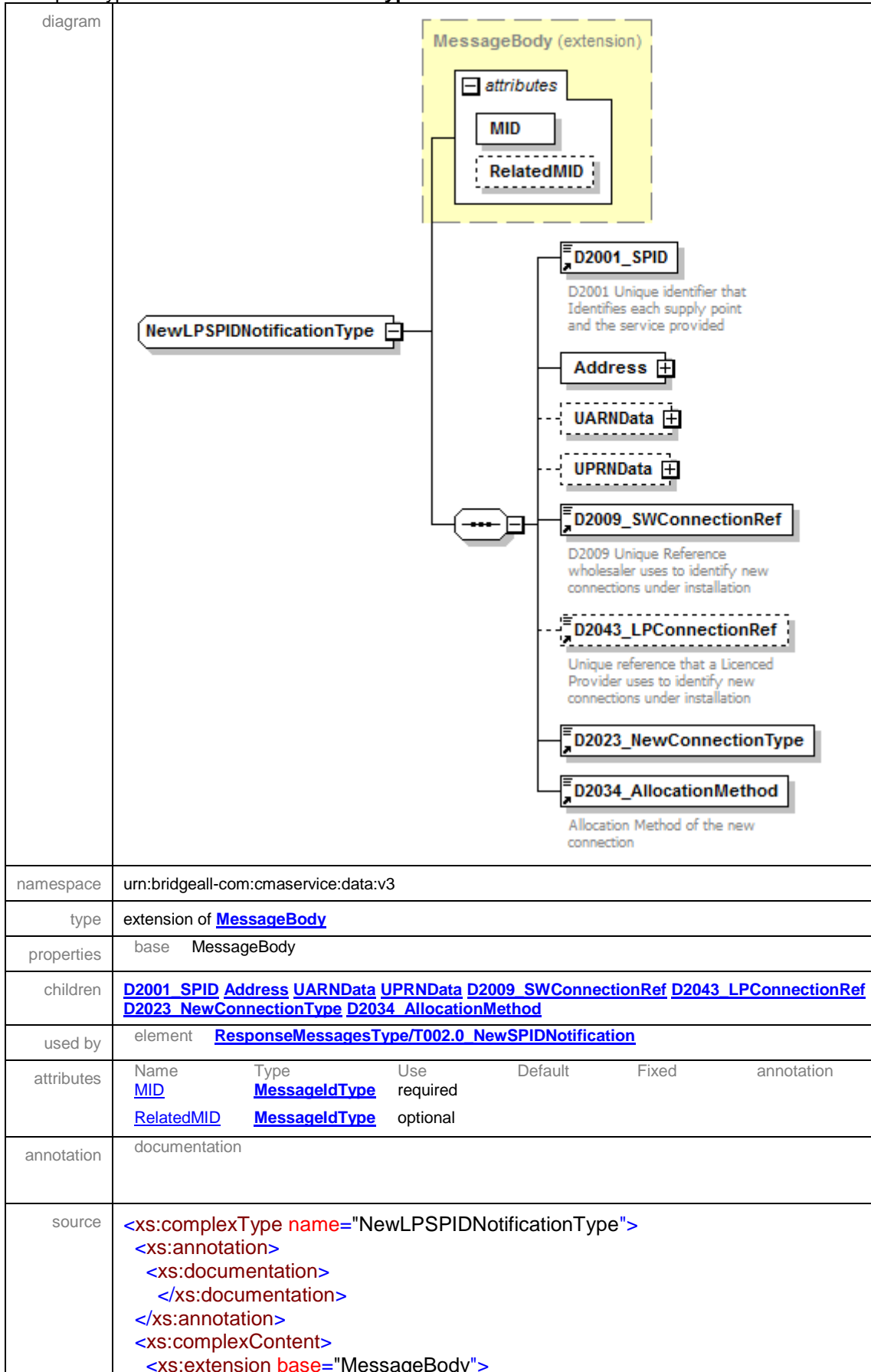

| | |
|--|--------------------------------------------------------------------------------------------------------------------------------------------------------------------------------------------------------------------------------------------------------------------------------------------------------------------------------------------------------------------------------------------------------------------------------------------------------------------------------------------------------------------------------------------------------------------------------------------------|
| | <pre> <xs:sequence> <xs:element ref="D2001_SPID"/> <xs:element name="Address" type="AddressType"/> <xs:element name="UARNDData" type="UARNTYPE" minOccurs="0"/> <xs:element name="UPRNDData" type="UPRNTYPE" minOccurs="0"/> <xs:element ref="D2009_SWConnectionRef"/> <xs:element ref="D2043_LPConnectionRef" minOccurs="0"/> <xs:element ref="D2023_NewConnectionType"/> <xs:element ref="D2034_AllocationMethod"/> </xs:sequence> </xs:extension> </xs:complexContent> </xs:complexType> </pre> |
|--|--------------------------------------------------------------------------------------------------------------------------------------------------------------------------------------------------------------------------------------------------------------------------------------------------------------------------------------------------------------------------------------------------------------------------------------------------------------------------------------------------------------------------------------------------------------------------------------------------|

element **NewLPSPIDNotificationType/Address**

| | |
|------------|-------------------------------------------------------------------------------------------------------------------------------------------------------------------------------------------------------------------------------------------------------------------------------------------------------------------------------------------------------------------------------------------------------------------------------------------------------------------------------------------------------------------------------|
| diagram | |
| namespace | urn:bridgeall-com:cmaservice:data:v3 |
| type | AddressType |
| properties | isRef 0 content complex |
| children | D5001_FreeDescriptor D5002_SubBuildingName D5003_BuildingName D5004_BuildingNumber D5005_DependentThoroughfareName D5006_DependentThoroughfareDescriptor D5007_ThoroughfareName D5008_ThoroughfareDescriptor D5009_DoubleDependentLocality D5010_DependentLocality D5011_PostTown D5012_County D5013_Postcode |
| source | <pre><xs:element name="Address" type="AddressType"/></pre> |

element **NewLPSPIDNotificationType/UARNDData**

| | |
|------------|---------------------------------------------------------------------------------------------------------------------------------------------------------------------------------------------------------------------------------------------------------------------------------------------------------------------------------------------------------------------------------------------------------------------------|
| diagram | <p>The diagram illustrates the structure of the UARNDData element. It is a dashed box containing a solid box labeled UARNType. Inside UARNType, there are two dashed boxes representing child elements: D2037_SAAReferenceNumber and D2038_SAAReferenceNumberAbsenceCode. The UARNDData element is connected to the UARNType element by a line with a small square at the end, indicating a containment relationship.</p> |
| namespace | urn:bridgeall-com:cmaservice:data:v3 |
| type | UARNType |
| properties | isRef 0 minOcc 0 maxOcc 1 content complex |
| children | D2037_SAAReferenceNumber D2038_SAAReferenceNumberAbsenceCode |
| source | <code><xs:element name="UARNDData" type="UARNType" minOccurs="0"/></code> |

element **NewLPSPIDNotificationType/UPRNDData**

| | |
|------------|-----------------------------------------------------------------------------------------------------------------------------------------------------------------------------------------------------------------------------------------------------------------------------------------------------------------------------------------------------------------------------------------------|
| diagram | <p>The diagram illustrates the structure of the UPRNDData element. It is a dashed box containing a solid box labeled UPRNType. Inside UPRNType, there are two dashed boxes representing child elements: D2039_UPRN and D2040_UPRNAbsenceCode. The UPRNDData element is connected to the UPRNType element by a line with a small square at the end, indicating a containment relationship.</p> |
| namespace | urn:bridgeall-com:cmaservice:data:v3 |
| type | UPRNType |
| properties | isRef 0 minOcc 0 maxOcc 1 content complex |
| children | D2039_UPRN D2040_UPRNAbsenceCode |
| source | <code><xs:element name="UPRNDData" type="UPRNType" minOccurs="0"/></code> |

complexType **NewSPIDNotificationType**

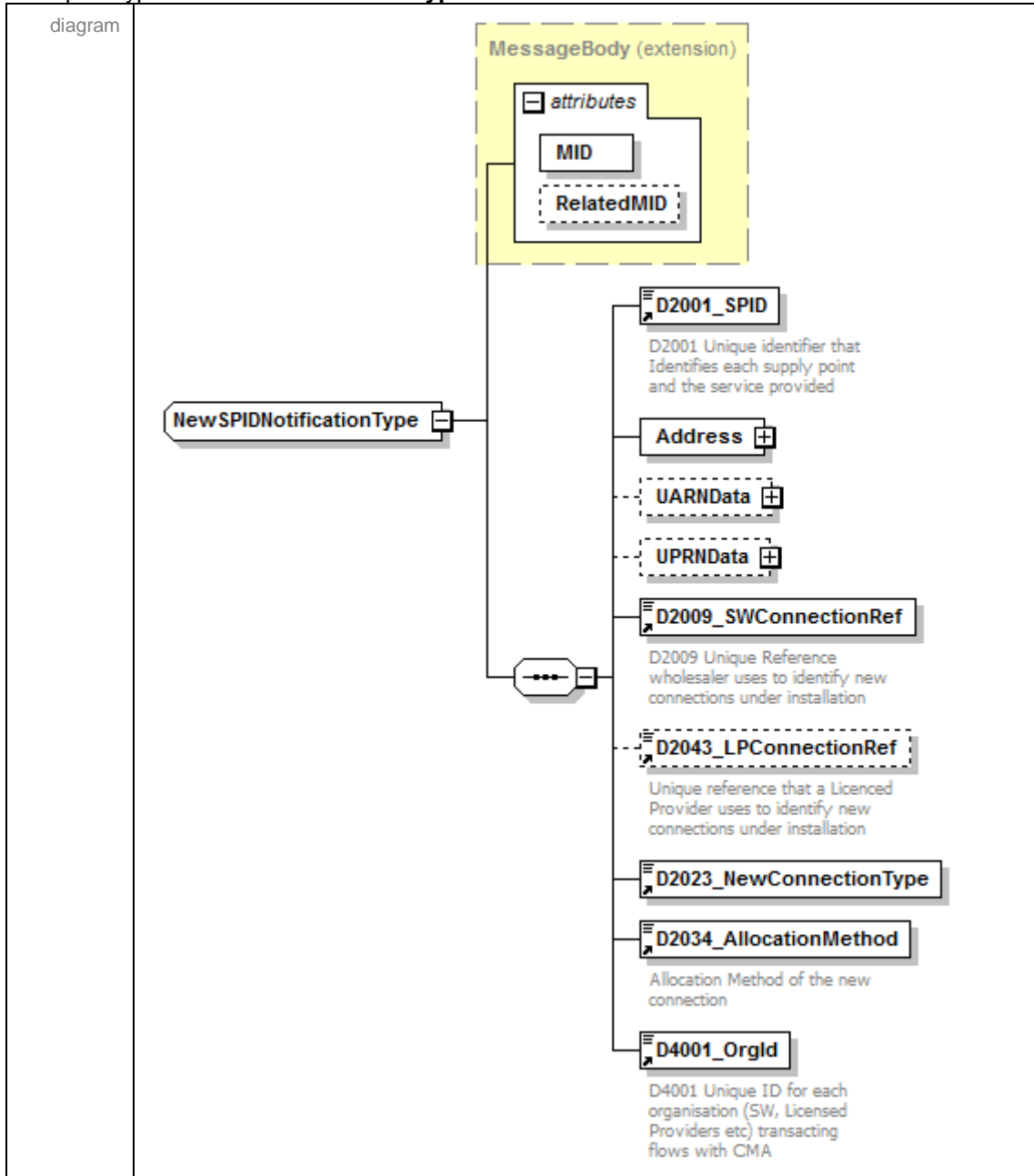

| | | | | | | |
|------------|-----------------------------------------------------------------------------------------------------------------------------------------------------------------------------------------------------------------------------------------------------------------------------------------------|-------------------------------|----------|---------|-------|------------|
| namespace | urn:bridgeall-com:cmaservice:data:v3 | | | | | |
| type | extension of MessageBody | | | | | |
| properties | base MessageBody | | | | | |
| children | D2001_SPID Address UARNDData UPRNDData D2009_SWConnectionRef D2043_LPConnectionRef D2023_NewConnectionType D2034_AllocationMethod D4001_OrgId | | | | | |
| used by | element ResponseMessagesType/T002.1 NewSPIDNotification | | | | | |
| attributes | Name | Type | Use | Default | Fixed | annotation |
| | MID | MessageIdType | required | | | |
| | RelatedMID | MessageIdType | optional | | | |
| annotation | documentation | | | | | |
| source | <code><xs:complexType name="NewSPIDNotificationType"> <xs:annotation></code> | | | | | |

```

<xs:documentation>
  </xs:documentation>
</xs:annotation>
<xs:complexContent>
  <xs:extension base="MessageBody">
    <xs:sequence>
      <xs:element ref="D2001_SPIID"/>
      <xs:element name="Address" type="AddressType"/>
      <xs:element name="UARNDData" type="UARNTYPE" minOccurs="0"/>
      <xs:element name="UPRNDData" type="UPRNTYPE" minOccurs="0"/>
      <xs:element ref="D2009_SWConnectionRef"/>
      <xs:element ref="D2043_LPConnectionRef" minOccurs="0"/>
      <xs:element ref="D2023_NewConnectionType"/>
      <xs:element ref="D2034_AllocationMethod"/>
      <xs:element ref="D4001_OrgId"/>
    </xs:sequence>
  </xs:extension>
</xs:complexContent>
</xs:complexType>

```

element **NewSPIDNotificationType/Address**

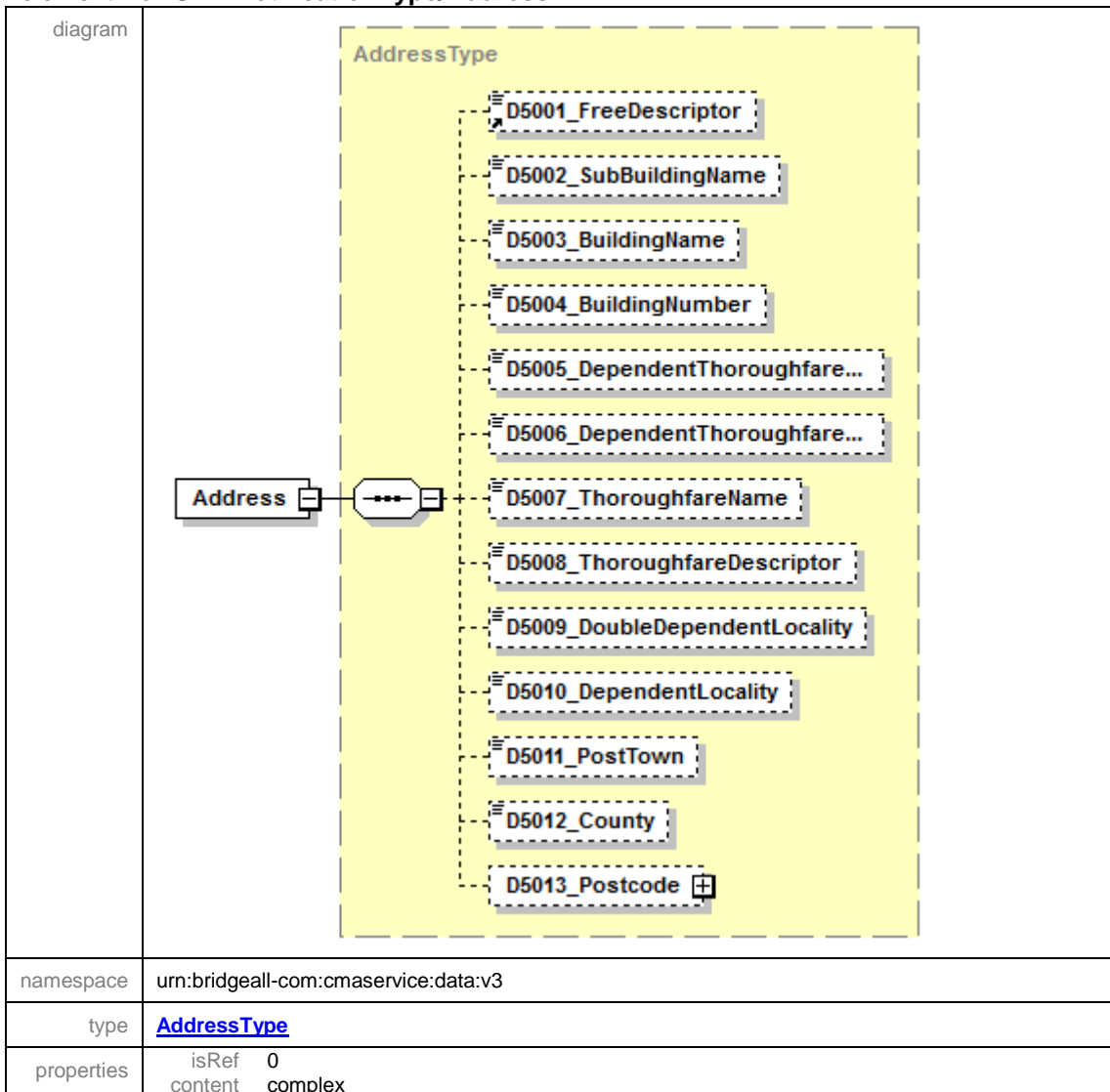

| | |
|----------|-------------------------------------------------------------------------------------------------------------------------------------------------------------------------------------------------------------------------------------------------------------------------------------------------------------------------------------------------------------------------------------------------------------------------------------------------------------------------------------------------------------------------------|
| children | D5001_FreeDescriptor D5002_SubBuildingName D5003_BuildingName D5004_BuildingNumber D5005_DependentThoroughfareName D5006_DependentThoroughfareDescriptor D5007_ThoroughfareName D5008_ThoroughfareDescriptor D5009_DoubleDependentLocality D5010_DependentLocality D5011_PostTown D5012_County D5013_Postcode |
| source | <xs:element name="Address" type="AddressType"/> |

element NewSPIDNotificationType/UARNDData

| | |
|------------|-------------------------------------------------------------------------------------------------------------------------------------------------------------------------------------------------------------------------------------------------------------------------------------------------------------------------------------------------------------------------------|
| diagram | <p>The diagram illustrates the structure of the UARNDData element. It is a dashed box containing a solid box labeled 'UARNType'. Inside 'UARNType', there are two dashed boxes representing child elements: 'D2037_SAAReferenceNumber' and 'D2038_SAAReferenceNumberAbsenceCode'. A line connects 'UARNDData' to 'UARNType', indicating that UARNDData contains UARNType.</p> |
| namespace | urn:bridgeall-com:cmaservice:data:v3 |
| type | UARNType |
| properties | isRef 0 minOcc 0 maxOcc 1 content complex |
| children | D2037_SAAReferenceNumber D2038_SAAReferenceNumberAbsenceCode |
| source | <xs:element name="UARNDData" type="UARNType" minOccurs="0"/> |

element NewSPIDNotificationType/UPRNDData

| | |
|------------|---------------------------------------------------------------------------------------------------------------------------------------------------------------------------------------------------------------------------------------------------------------------------------------------------------------------------------------------------|
| diagram | <p>The diagram illustrates the structure of the UPRNDData element. It is a dashed box containing a solid box labeled 'UPRNType'. Inside 'UPRNType', there are two dashed boxes representing child elements: 'D2039_UPRN' and 'D2040_UPRNAbsenceCode'. A line connects 'UPRNDData' to 'UPRNType', indicating that UPRNDData contains UPRNType.</p> |
| namespace | urn:bridgeall-com:cmaservice:data:v3 |
| type | UPRNType |
| properties | isRef 0 minOcc 0 maxOcc 1 content complex |
| children | D2039_UPRN D2040_UPRNAbsenceCode |
| source | <xs:element name="UPRNDData" type="UPRNType" minOccurs="0"/> |

complexType **NewSPIDRequestType**

| <p>diagram</p> | | | | | | | | | | | | | | | | | | | |
|----------------------------|--------------------------------------------------------------------------------------------------------------------------------------------------------------------------------------------------------------------------------------------------------------------------------------------------------------------------------------------------------------------------------------------------------------------------------------------|----------|---------|-------|------------|-------|------------|---------------------|-------------------------------|----------|--|--|--|----------------------------|-------------------------------|----------|--|--|--|
| <p>namespace</p> | <p>urn:bridgeall-com:cmaservice:data:v3</p> | | | | | | | | | | | | | | | | | | |
| <p>type</p> | <p>extension of MessageBody</p> | | | | | | | | | | | | | | | | | | |
| <p>properties</p> | <p>base MessageBody</p> | | | | | | | | | | | | | | | | | | |
| <p>children</p> | <p>D2001_SPID D2009_SWConnectionRef D2043_LPConnectionRef D4001_OrgId D2002_ServiceCategory SPIDLocation D2023_NewConnectionType UARNDData UPRNDData</p> | | | | | | | | | | | | | | | | | | |
| <p>used by</p> | <p>element MessagesType/T001.0_NewSPIDRequests/T001.0_NewSPIDRequest</p> | | | | | | | | | | | | | | | | | | |
| <p>attributes</p> | <table border="1"> <thead> <tr> <th>Name</th> <th>Type</th> <th>Use</th> <th>Default</th> <th>Fixed</th> <th>annotation</th> </tr> </thead> <tbody> <tr> <td>MID</td> <td>MessageIdType</td> <td>required</td> <td></td> <td></td> <td></td> </tr> <tr> <td>RelatedMID</td> <td>MessageIdType</td> <td>optional</td> <td></td> <td></td> <td></td> </tr> </tbody> </table> | Name | Type | Use | Default | Fixed | annotation | MID | MessageIdType | required | | | | RelatedMID | MessageIdType | optional | | | |
| Name | Type | Use | Default | Fixed | annotation | | | | | | | | | | | | | | |
| MID | MessageIdType | required | | | | | | | | | | | | | | | | | |
| RelatedMID | MessageIdType | optional | | | | | | | | | | | | | | | | | |
| <p>annotation</p> | <p>documentation</p> | | | | | | | | | | | | | | | | | | |
| <p>source</p> | <pre><xs:complexType name="NewSPIDRequestType"> <xs:annotation> <xs:documentation></pre> | | | | | | | | | | | | | | | | | | |

| | |
|--|-------------------------------------------------------------------------------------------------------------------------------------------------------------------------------------------------------------------------------------------------------------------------------------------------------------------------------------------------------------------------------------------------------------------------------------------------------------------------------------------------------------------------------------------------------------------------------------------------------------------------------------------------------------------------------------------------------------------------------------------------------------------------------------------------------------------------------------------------------------------------|
| | <pre> </xs:documentation> </xs:annotation> <xs:complexContent> <xs:extension base="MessageBody"> <xs:sequence> <xs:element ref="D2001_SPID" minOccurs="0"/> <xs:element ref="D2009_SWConnectionRef"/> <xs:element ref="D2043_LPConnectionRef" minOccurs="0"/> <xs:element ref="D4001_OrgId" minOccurs="0"/> <xs:element name="D2002_ServiceCategory" type="ServiceCategoryType"/> <xs:element name="SPIDLocation" type="AddressType"/> <xs:element ref="D2023_NewConnectionType"/> <xs:element name="UARNDData" type="UARNTYPE" minOccurs="0"/> <xs:element name="UPRNDData" type="UPRNType" minOccurs="0"/> </xs:sequence> </xs:extension> </xs:complexContent> </xs:complexType> </pre> |
|--|-------------------------------------------------------------------------------------------------------------------------------------------------------------------------------------------------------------------------------------------------------------------------------------------------------------------------------------------------------------------------------------------------------------------------------------------------------------------------------------------------------------------------------------------------------------------------------------------------------------------------------------------------------------------------------------------------------------------------------------------------------------------------------------------------------------------------------------------------------------------------|

element **NewSPIDRequestType/D2002_ServiceCategory**

| | |
|------------|----------------------------------------------------------------------------------------|
| diagram |  |
| namespace | urn:bridgeall-com:cmaservice:data:v3 |
| type | ServiceCategoryType |
| properties | isRef 0 content simple |
| facets | Kind Value annotation enumeration 01 enumeration 02 |
| source | <pre><xs:element name="D2002_ServiceCategory" type="ServiceCategoryType"/></pre> |

element **NewSPIDRequestType/SPIDLocation**

| | |
|-------------------|--------------------------------------------------------------------------------------------------------------------------------------------------------------------------------------------------------------------------------------------------------------------------------------------------------------------------------------------------------------------------------------------------------------------------------------------------------------------------------------------------------------------------------------|
| <p>diagram</p> | |
| <p>namespace</p> | <p>urn:bridgeall-com:cmaservice:data:v3</p> |
| <p>type</p> | <p>AddressType</p> |
| <p>properties</p> | <p>isRef 0 content complex</p> |
| <p>children</p> | <p>D5001_FreeDescriptor D5002_SubBuildingName D5003_BuildingName D5004_BuildingNumber D5005_DependentThoroughfareName D5006_DependentThoroughfareDescriptor D5007_ThoroughfareName D5008_ThoroughfareDescriptor D5009_DoubleDependentLocality D5010_DependentLocality D5011_PostTown D5012_County D5013_Postcode</p> |
| <p>source</p> | <p><code><xs:element name="SPIDLocation" type="AddressType"/></code></p> |

element **NewSPIDRequestType/UARNData**

| | |
|-------------------|---------------------------------------------|
| <p>diagram</p> | |
| <p>namespace</p> | <p>urn:bridgeall-com:cmaservice:data:v3</p> |
| <p>type</p> | <p>UARNTYPE</p> |
| <p>properties</p> | <p>isRef 0 minOcc 0 maxOcc 1</p> |

| | |
|----------|----------------------------------------------------------------------------------------|
| | content complex |
| children | D2037_SAARefereNumber D2038_SAARefereNumberAbsenceCode |
| source | <code><xs:element name="UARNDData" type="UARNTType" minOccurs="0"/></code> |

element NewSPIDRequestType/UPRNDData

| | |
|------------|----------------------------------------------------------------------------------|
| diagram | |
| namespace | urn:bridgeall-com:cmaservice:data:v3 |
| type | UPRNTType |
| properties | isRef 0 minOcc 0 maxOcc 1 content complex |
| children | D2039_UPRN D2040_UPRNBabsenceCode |
| source | <code><xs:element name="UPRNDData" type="UPRNTType" minOccurs="0"/></code> |

complexType NotificationType

| | |
|------------|---------------------------------------------------------------------------------------------------------------------------------------------------------------------------------------------------------------------------------------------------------------------------------|
| diagram | |
| namespace | urn:bridgeall-com:cmaservice:data:v3 |
| type | extension of MessageBody |
| properties | base MessageBody |
| children | D1008_DataItemRef D4004_ReturnCode D2001_SPID |
| used by | elements ResponseMessagesType/T009.0_Notification ResponseMessagesType/T009.1_Notification MessagesType/T009.2_Notifications/T009.2_Notification MessagesType/T009.3_Notifications/T009.3_Notification |

| | | | | | | |
|------------|---------------------------------------------------------------------------------------------------------------------------------------------------------------------------------------------------------------------------------------------------------------------------------------------------------------------------------------------------------------------------------------------------------------------------------------------------------------------------------------------------------------------------------------------------------------------------------------------|------------------------------------------------------------------------|-----------------------------|---------|-------|------------|
| attributes | Name MID RelatedMID | Type MessageIdType MessageIdType | Use required optional | Default | Fixed | annotation |
| annotation | documentation | | | | | |
| source | <pre> <xs:complexType name="NotificationType"> <xs:annotation> <xs:documentation> </xs:documentation> </xs:annotation> <xs:complexContent> <xs:extension base="MessageBody"> <xs:sequence> <xs:element ref="D1008_DataItemRef" minOccurs="0"/> <xs:element ref="D4004_ReturnCode"/> <xs:element ref="D2001_SPID" minOccurs="0"/> </xs:sequence> </xs:extension> </xs:complexContent> </xs:complexType> </pre> | | | | | |

complexType NotifyRSDType

| | | | | | | |
|------------|----------------------------------------------------------------------------------------------------|---------------------------------------|-----------------|---------|-------|------------|
| diagram | | | | | | |
| namespace | urn:bridgeall-com:cmaservice:data:v3 | | | | | |
| type | extension of MessageBody | | | | | |
| properties | base MessageBody | | | | | |
| children | D2001_SPID D4001_OrgId D4002_RegistrationStartDate | | | | | |
| used by | element ResponseMessagesType/T008.2_NotifyRSD | | | | | |
| attributes | Name MID | Type MessageIdType | Use required | Default | Fixed | annotation |

| | |
|--------|--------------------------------------------------------------------------------------------------------------------------------------------------------------------------------------------------------------------------------------------------------------------------------------------------------------------------------------------------------------------------------------------------------------------------------------------------------------------------------------------------------------|
| | RelatedMID MessageIdType optional |
| source | <pre> <xs:complexType name="NotifyRSDType"> <xs:annotation> <xs:documentation/> </xs:annotation> <xs:complexContent> <xs:extension base="MessageBody"> <xs:sequence> <xs:element ref="D2001_SPID"/> <xs:element ref="D4001_OrgId"/> <xs:element ref="D4002_RegistrationStartDate"/> </xs:sequence> </xs:extension> </xs:complexContent> </xs:complexType> </pre> |

complexType **PartialRegistrationApplicationType**

| diagram | | | | | | | | | | | | | | | | | | | |
|----------------------------|--------------------------------------------------------------------------------------------------------------------------------------------------------------------------------------------------------------------------------------------------------------------------------------------------------------------------------------------------------------------------------------------------------------------------------------------|----------|---------|-------|------------|-------|------------|---------------------|-------------------------------|----------|--|--|--|----------------------------|-------------------------------|----------|--|--|--|
| namespace | urn:bridgeall-com:cmaservice:data:v3 | | | | | | | | | | | | | | | | | | |
| type | extension of MessageBody | | | | | | | | | | | | | | | | | | |
| properties | base MessageBody | | | | | | | | | | | | | | | | | | |
| children | D2001_SPID | | | | | | | | | | | | | | | | | | |
| used by | element MessagesType/T003.0_PartialRegistrationApplications/T003.0_PartialRegistrationApplication | | | | | | | | | | | | | | | | | | |
| attributes | <table border="1"> <thead> <tr> <th>Name</th> <th>Type</th> <th>Use</th> <th>Default</th> <th>Fixed</th> <th>annotation</th> </tr> </thead> <tbody> <tr> <td>MID</td> <td>MessageIdType</td> <td>required</td> <td></td> <td></td> <td></td> </tr> <tr> <td>RelatedMID</td> <td>MessageIdType</td> <td>optional</td> <td></td> <td></td> <td></td> </tr> </tbody> </table> | Name | Type | Use | Default | Fixed | annotation | MID | MessageIdType | required | | | | RelatedMID | MessageIdType | optional | | | |
| Name | Type | Use | Default | Fixed | annotation | | | | | | | | | | | | | | |
| MID | MessageIdType | required | | | | | | | | | | | | | | | | | |
| RelatedMID | MessageIdType | optional | | | | | | | | | | | | | | | | | |
| annotation | documentation T003.0 | | | | | | | | | | | | | | | | | | |
| source | <pre> <xs:complexType name="PartialRegistrationApplicationType"> <xs:annotation> <xs:documentation>T003.0</xs:documentation> </xs:annotation> <xs:complexContent> <xs:extension base="MessageBody"> <xs:sequence> <xs:element ref="D2001_SPID"/> </xs:sequence> </xs:extension> </xs:complexContent> </pre> | | | | | | | | | | | | | | | | | | |

| | |
|--|--------------------------------------|
| | <code></xs:complexType></code> |
|--|--------------------------------------|

complexType **PostcodeType**

| | |
|-----------|-----------------------------------------------------------------------------------------------------------------------------------------------------------------------------------------------------------------------------------------------------------------------------------------------------------------------------------------------------------------------------------------------------------------------------------------------------------------------------------------------------------------------------------------------------------------------------------------------------------------------------------------------------------------------------------------------------------------------------------------------------------------------------------------------------------------------------------------------------------------------|
| diagram | |
| namespace | urn:bridgeall-com:cmaservice:data:v3 |
| children | Outcode Incode |
| used by | element AddressType/D5013 Postcode |
| source | <pre> <xs:complexType name="PostcodeType"> <xs:sequence> <xs:element name="Outcode" minOccurs="0"> <xs:simpleType> <xs:restriction base="xs:string"> <xs:maxLength value="4"/> <xs:whiteSpace value="preserve"/> <xs:pattern value="([A-Z][0-9])*"/> </xs:restriction> </xs:simpleType> </xs:element> <xs:element name="Incode" minOccurs="0"> <xs:simpleType> <xs:restriction base="xs:string"> <xs:maxLength value="3"/> <xs:whiteSpace value="preserve"/> <xs:pattern value="([A-Z][0-9])*"/> </xs:restriction> </xs:simpleType> </xs:element> </xs:sequence> </xs:complexType> </pre> |

element **PostcodeType/Outcode**

| diagram | | | | | | | | | | | | | |
|------------|-----------------------------------------------------------------------------------------------------------------------------------------------------------------------------------------------------------------------------------------------------------------------------------------------|------------|-------|------------|-----------|--------|---|------------|----------|--|---------|---------------|--|
| namespace | urn:bridgeall-com:cmaservice:data:v3 | | | | | | | | | | | | |
| type | restriction of xs:string | | | | | | | | | | | | |
| properties | <table> <tr><td>isRef</td><td>0</td></tr> <tr><td>minOcc</td><td>0</td></tr> <tr><td>maxOcc</td><td>1</td></tr> <tr><td>content</td><td>simple</td></tr> </table> | isRef | 0 | minOcc | 0 | maxOcc | 1 | content | simple | | | | |
| isRef | 0 | | | | | | | | | | | | |
| minOcc | 0 | | | | | | | | | | | | |
| maxOcc | 1 | | | | | | | | | | | | |
| content | simple | | | | | | | | | | | | |
| facets | <table> <thead> <tr> <th>Kind</th> <th>Value</th> <th>annotation</th> </tr> </thead> <tbody> <tr> <td>maxLength</td> <td>4</td> <td></td> </tr> <tr> <td>whiteSpace</td> <td>preserve</td> <td></td> </tr> <tr> <td>pattern</td> <td>([A-Z][0-9]*)</td> <td></td> </tr> </tbody> </table> | Kind | Value | annotation | maxLength | 4 | | whiteSpace | preserve | | pattern | ([A-Z][0-9]*) | |
| Kind | Value | annotation | | | | | | | | | | | |
| maxLength | 4 | | | | | | | | | | | | |
| whiteSpace | preserve | | | | | | | | | | | | |
| pattern | ([A-Z][0-9]*) | | | | | | | | | | | | |
| source | <pre> <xs:element name="Outcode" minOccurs="0"> <xs:simpleType> <xs:restriction base="xs:string"> <xs:maxLength value="4"/> <xs:whiteSpace value="preserve"/> </xs:restriction> </xs:simpleType> </xs:element> </pre> | | | | | | | | | | | | |

| | |
|--|---------------------------------------------------------------------------------------------------------------------------|
| | <pre> <xs:pattern value="([A-Z][0-9])*"/> </xs:restriction> </xs:simpleType> </xs:element> </pre> |
|--|---------------------------------------------------------------------------------------------------------------------------|

element PostcodeType/Incode

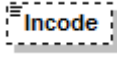
| | | | | | | | | | | | | | |
|------------|----------------------------------------------------------------------------------------------------------------------------------------------------------------------------------------------------------------------------------------------------------------------------------------------------------------------------------------------|------------|-------|------------|-----------|--------|---|------------|----------|--|---------|----------------|--|
| diagram |  | | | | | | | | | | | | |
| namespace | urn:bridgeall-com:cmaservice:data:v3 | | | | | | | | | | | | |
| type | restriction of xs:string | | | | | | | | | | | | |
| properties | <table border="0"> <tr><td>isRef</td><td>0</td></tr> <tr><td>minOcc</td><td>0</td></tr> <tr><td>maxOcc</td><td>1</td></tr> <tr><td>content</td><td>simple</td></tr> </table> | isRef | 0 | minOcc | 0 | maxOcc | 1 | content | simple | | | | |
| isRef | 0 | | | | | | | | | | | | |
| minOcc | 0 | | | | | | | | | | | | |
| maxOcc | 1 | | | | | | | | | | | | |
| content | simple | | | | | | | | | | | | |
| facets | <table border="0"> <tr><td>Kind</td><td>Value</td><td>annotation</td></tr> <tr><td>maxLength</td><td>3</td><td></td></tr> <tr><td>whiteSpace</td><td>preserve</td><td></td></tr> <tr><td>pattern</td><td>(([A-Z][0-9])*</td><td></td></tr> </table> | Kind | Value | annotation | maxLength | 3 | | whiteSpace | preserve | | pattern | (([A-Z][0-9])* | |
| Kind | Value | annotation | | | | | | | | | | | |
| maxLength | 3 | | | | | | | | | | | | |
| whiteSpace | preserve | | | | | | | | | | | | |
| pattern | (([A-Z][0-9])* | | | | | | | | | | | | |
| source | <pre> <xs:element name="Incode" minOccurs="0"> <xs:simpleType> <xs:restriction base="xs:string"> <xs:maxLength value="3"/> <xs:whiteSpace value="preserve"/> <xs:pattern value="([A-Z][0-9])*"/> </xs:restriction> </xs:simpleType> </xs:element> </pre> | | | | | | | | | | | | |

complexType **PremisesSpecialArrangementsUpdateNotificationType**

| <p>diagram</p> | <p>The diagram illustrates the structure of the PremisesSpecialArrangementsUpdateNotificationType complex type. It is an extension of the MessageBody type. The MessageBody (extension) contains an attributes container with two elements: MID (required) and RelatedMID (optional). The PremisesSpecialArrangementsUpdateNotificationType contains a sequence of four elements: D2001_SPID (required), D4006_EffectiveFrom (required), D2004_ExemptCustomerFlag (optional), and D2041_PcentExemption (optional). Each element has a corresponding description: D2001_SPID is a unique identifier for supply points and services; D4006_EffectiveFrom details the effective date; D2004_ExemptCustomerFlag is a Scottish Executive Exempt Scheme flag; and D2041_PcentExemption is the percentage of the exempt customer flag applied.</p> | | | | | | | | | | | | | | | | | | |
|----------------------------|------------------------------------------------------------------------------------------------------------------------------------------------------------------------------------------------------------------------------------------------------------------------------------------------------------------------------------------------------------------------------------------------------------------------------------------------------------------------------------------------------------------------------------------------------------------------------------------------------------------------------------------------------------------------------------------------------------------------------------------------------------------------------------------------------------------------------------------------------------------------------------------------------------------------------------------------------|----------|---------|-------|------------|-------|------------|---------------------|-------------------------------|----------|--|--|--|----------------------------|-------------------------------|----------|--|--|--|
| <p>namespace</p> | <p>urn:bridgeall-com:cmaservice:data:v3</p> | | | | | | | | | | | | | | | | | | |
| <p>type</p> | <p>extension of MessageBody</p> | | | | | | | | | | | | | | | | | | |
| <p>properties</p> | <p>base MessageBody</p> | | | | | | | | | | | | | | | | | | |
| <p>children</p> | <p>D2001_SPID D4006_EffectiveFrom D2004_ExemptCustomerFlag D2041_PcentExemption</p> | | | | | | | | | | | | | | | | | | |
| <p>used by</p> | <p>element ResponseMessagesType/T029.4_PremisesSpecialArrangementsUpdateNotification</p> | | | | | | | | | | | | | | | | | | |
| <p>attributes</p> | <table border="1"> <thead> <tr> <th>Name</th> <th>Type</th> <th>Use</th> <th>Default</th> <th>Fixed</th> <th>annotation</th> </tr> </thead> <tbody> <tr> <td>MID</td> <td>MessageIdType</td> <td>required</td> <td></td> <td></td> <td></td> </tr> <tr> <td>RelatedMID</td> <td>MessageIdType</td> <td>optional</td> <td></td> <td></td> <td></td> </tr> </tbody> </table> | Name | Type | Use | Default | Fixed | annotation | MID | MessageIdType | required | | | | RelatedMID | MessageIdType | optional | | | |
| Name | Type | Use | Default | Fixed | annotation | | | | | | | | | | | | | | |
| MID | MessageIdType | required | | | | | | | | | | | | | | | | | |
| RelatedMID | MessageIdType | optional | | | | | | | | | | | | | | | | | |
| <p>annotation</p> | <p>documentation</p> | | | | | | | | | | | | | | | | | | |
| <p>source</p> | <pre><xs:complexType name="PremisesSpecialArrangementsUpdateNotificationType"> <xs:annotation> <xs:documentation> </xs:documentation> </xs:annotation> <xs:complexContent> <xs:extension base="MessageBody"> <xs:sequence> <xs:element ref="D2001_SPID"/> <xs:element ref="D4006_EffectiveFrom"/> <xs:element ref="D2004_ExemptCustomerFlag" minOccurs="0"/> <xs:element ref="D2041_PcentExemption" minOccurs="0"/> </xs:sequence> </xs:extension> </xs:complexContent> </xs:complexType></pre> | | | | | | | | | | | | | | | | | | |

complexType **PremisesSpecialArrangementsUpdateType**

| <p>diagram</p> | | | | | | | | | | | | | | | | | | | |
|----------------------------|---------------------------------------------------------------------------------------------------------------------------------------------------------------------------------------------------------------------------------------------------------------------------------------------------------------------------------------------------------------------------------------------------------------------------------------------------------------------------------------------------------------------------------------------------------------------------------------------------------------------------------------------------------|----------|---------|-------|------------|-------|------------|---------------------|-------------------------------|----------|--|--|--|----------------------------|-------------------------------|----------|--|--|--|
| <p>namespace</p> | <p>urn:bridgeall-com:cmaservice:data:v3</p> | | | | | | | | | | | | | | | | | | |
| <p>type</p> | <p>extension of MessageBody</p> | | | | | | | | | | | | | | | | | | |
| <p>properties</p> | <p>base MessageBody</p> | | | | | | | | | | | | | | | | | | |
| <p>children</p> | <p>D2001_SPID D4006_EffectiveFrom D2004_ExemptCustomerFlag D2041_PcentExemption</p> | | | | | | | | | | | | | | | | | | |
| <p>used by</p> | <p>element MessagesType/T029.3 PremisesSpecialArrangementsUpdates/T029.3 PremisesSpecialArrangementsUpdate</p> | | | | | | | | | | | | | | | | | | |
| <p>attributes</p> | <table border="1"> <thead> <tr> <th>Name</th> <th>Type</th> <th>Use</th> <th>Default</th> <th>Fixed</th> <th>annotation</th> </tr> </thead> <tbody> <tr> <td>MID</td> <td>MessageIdType</td> <td>required</td> <td></td> <td></td> <td></td> </tr> <tr> <td>RelatedMID</td> <td>MessageIdType</td> <td>optional</td> <td></td> <td></td> <td></td> </tr> </tbody> </table> | Name | Type | Use | Default | Fixed | annotation | MID | MessageIdType | required | | | | RelatedMID | MessageIdType | optional | | | |
| Name | Type | Use | Default | Fixed | annotation | | | | | | | | | | | | | | |
| MID | MessageIdType | required | | | | | | | | | | | | | | | | | |
| RelatedMID | MessageIdType | optional | | | | | | | | | | | | | | | | | |
| <p>annotation</p> | <p>documentation</p> | | | | | | | | | | | | | | | | | | |
| <p>source</p> | <pre><xs:complexType name="PremisesSpecialArrangementsUpdateType"> <xs:annotation> <xs:documentation> </xs:documentation> </xs:annotation> <xs:complexContent> <xs:extension base="MessageBody"> <xs:sequence> <xs:element ref="D2001_SPID"/> <xs:element ref="D4006_EffectiveFrom"/> <xs:element ref="D2004_ExemptCustomerFlag" minOccurs="0"/> <xs:element ref="D2041_PcentExemption" minOccurs="0"/> </xs:sequence> </xs:extension> </xs:complexContent> </xs:complexType></pre> | | | | | | | | | | | | | | | | | | |

</xs:complexType>

complexType **RegistrationStartType**

| diagram | | | | | | | | | | | | | | | | | | | |
|----------------------------|------------------------------------------------------------------------------------------------------------------------------------------------------------------------------------------------------------------------------------------------------------------------------------------------------------------------------------------------------------------------------------------------------------------------------------------------------------------------|----------|---------|-------|------------|-------|------------|---------------------|-------------------------------|----------|--|--|--|----------------------------|-------------------------------|----------|--|--|--|
| namespace | urn:bridgeall-com:cmaservice:data:v3 | | | | | | | | | | | | | | | | | | |
| type | extension of MessageBody | | | | | | | | | | | | | | | | | | |
| properties | base MessageBody | | | | | | | | | | | | | | | | | | |
| children | D2001_SPID D4002_RegistrationStartDate | | | | | | | | | | | | | | | | | | |
| used by | elements ResponseMessagesType/T008.0 TerminationNotification ResponseMessagesType/T008.1 RegistrationConfirmation | | | | | | | | | | | | | | | | | | |
| attributes | <table border="1"> <thead> <tr> <th>Name</th> <th>Type</th> <th>Use</th> <th>Default</th> <th>Fixed</th> <th>annotation</th> </tr> </thead> <tbody> <tr> <td>MID</td> <td>MessageIdType</td> <td>required</td> <td></td> <td></td> <td></td> </tr> <tr> <td>RelatedMID</td> <td>MessageIdType</td> <td>optional</td> <td></td> <td></td> <td></td> </tr> </tbody> </table> | Name | Type | Use | Default | Fixed | annotation | MID | MessageIdType | required | | | | RelatedMID | MessageIdType | optional | | | |
| Name | Type | Use | Default | Fixed | annotation | | | | | | | | | | | | | | |
| MID | MessageIdType | required | | | | | | | | | | | | | | | | | |
| RelatedMID | MessageIdType | optional | | | | | | | | | | | | | | | | | |
| source | <pre> <xs:complexType name="RegistrationStartType"> <xs:annotation> <xs:documentation/> </xs:annotation> <xs:complexContent> <xs:extension base="MessageBody"> <xs:sequence> <xs:element ref="D2001_SPID"/> <xs:element ref="D4002_RegistrationStartDate"/> </xs:sequence> </xs:extension> </xs:complexContent> </xs:complexType> </pre> | | | | | | | | | | | | | | | | | | |

complexType **ResponseMessagesType**

| | |
|----------------------------------------------------------------------------------------------------|---------------------------------------------------------------------------------------------------------------------------------------------------------------------------------------------------------------------------------------------------------------------------------------------------------------------------------------------------------------------------------------------|
| <p>diagram</p>  | |
| <p>namespace</p> | <p>urn:bridgeall-com:cmaservice:data:v3</p> |
| <p>children</p> | <p>T002.0 NewSPIDNotification T002.1 NewSPIDNotification T004.1 NewMeterNotification T005.2 MeterReadNotification T005.3 MeterReadNotification T006.4 WaterSPIDNotification T006.5 SewerageSPIDNotification T006.7 ProvideLiveRateableValueNotification</p> |

| | |
|---------|-------------------------------------------------------------------------------------------------------------------------------------------------------------------------------------------------------------------------------------------------------------------------------------------------------------------------------------------------------------------------------------------------------------------------------------------------------------------------------------------------------------------------------------------------------------------------------------------------------------------------------------------------------------------------------------------------------------------------------------------------------------------------------------------------------------------------------------------------------------------------------------------------------------------------------------------------------------------------------------------------------------------------------------------------------------------------------------------------------------------------------------------------------------------------------------------------------------------------------------------------------------------------------------------------------------------------------------------------------------------------------------------------------------------------------------------------------------------------------------------------------------------------------------------------------------------------------------------------------------------------------------------------------------------------------------------------------------------------------------------------------------------------------------------------------------------------------------------------------------------------------------------------------------------------------------------------------------------------------------------------------------------------------------------------------------------------------------------------------------------------------------------------------------------------------------------------------------------------------------------------------------------------------------------------------------------------------|
| | <p>T007.2 ConnectionCompleteNotification T008.0 TerminationNotification T008.1 RegistrationConfirmation T008.2 NotifyRSD T009.0 Notification T009.1 Notification T009.4 Notification T011.0 CancelRegistrationNotificationIncoming T011.1 CancelRegistrationNotificationOutgoing T012.2 ServiceElementUpdateNotification T012.4 SewerageServiceElementUpdateNotification T012.6 UpdateSAARefereceNumberUPRNNotification T012.8 UpdateLiveRateableValueNotification T013.1 MeterUpdate T013.3 UpdateMeterLocationNotification T014.1 MeterUpdateNotification T015.1 DisconnectionNotification T016.1 UnmeasureableNotification T017.1 MeterSwapNotification T019.0 WaterSPIDData T020.0 SewerageSPIDData T021.1 DPIDNotification T022.1 TEUpdateNotification T023.1 MeterAssociationNotification T024.1 MeterDisAssociationNotification T026.1 DiscontinueDPIDNotification T027.1 DPIDUpdateNotification T028.0 Schedule3UpdateNotification T029.0 SpecialArrangementsUpdateNotification T029.4 PremisesSpecialArrangementsUpdateNotification T030.0 DPMeterReadNotification T030.1 DPMeterReadNotification T032.1 CustomerNameUpdated T032.2 CustomerNameUpdatedNotification T033.1 MeteredBuildingUpdate T034.1 VacSchemeGracePeriodNotification T034.2 VacSchemeGraceEndNotification T034.3 VacSchemeApplicationNotification T034.5 VacSchemeApplicationConfirmationOrCancellationNotification T035.0 TradeabilityNotification T035.1 TradeabilityNotification T036.1 MeterNetworkAssociationNotification</p> |
| used by | element ResponseMessages |
| source | <pre><xs:complexType name="ResponseMessagesType"> <xs:sequence> <xs:choice maxOccurs="unbounded"> <xs:element name="T002.0_NewSPIDNotification" type="NewLPSPIDNotificationType"/> <xs:element name="T002.1_NewSPIDNotification" type="NewSPIDNotificationType"/> <xs:element name="T004.1_NewMeterNotification" type="T004.1_NewMeterNotificationType"/> <xs:element name="T005.2_MeterReadNotification" type="MeterReadNotificationType"/> <xs:element name="T005.3_MeterReadNotification" type="MeterReadNotificationType"/> <xs:element name="T006.4_WaterSPIDNotification" type="T006.4_WaterSPIDNotificationType"/> <xs:element name="T006.5_SewerageSPIDNotification" type="T006.5_SewerageSPIDNotificationType"/> <xs:element name="T006.7_ProvideLiveRateableValueNotification" type="T006.7_ProvideLiveRateableValueNotificationType"/> <xs:element name="T007.2_ConnectionCompleteNotification" type="ConnectionCompleteType"/> <xs:element name="T008.0_TerminationNotification" type="RegistrationStartType"/> <xs:element name="T008.1_RegistrationConfirmation" type="RegistrationStartType"/> <xs:element name="T008.2_NotifyRSD" type="NotifyRSDType"/> <xs:element name="T009.0_Notification" type="NotificationType"/> <xs:element name="T009.1_Notification" type="NotificationType"/> <xs:element name="T009.4_Notification" type="T009.4_NotificationType"/> <xs:element name="T011.0_CancelRegistrationNotificationIncoming" type="CancelRegistrationNotificationType"/> <xs:element name="T011.1_CancelRegistrationNotificationOutgoing" type="CancelRegistrationNotificationOutType"/> <xs:element name="T012.2_ServiceElementUpdateNotification" type="ServiceElementUpdateNotificationType"/> <xs:element name="T012.4_SewerageServiceElementUpdateNotification" type="SewerageServiceElementUpdateNotificationType"/> <xs:element name="T012.6_UpdateSAARefereceNumberUPRNNotification" type="UpdateSAARefereceNumberUPRNNotificationType"/> <xs:element name="T012.8_UpdateLiveRateableValueNotification"</pre> |

```

type="T012.8_UpdateLiveRateableValueNotificationType"/>
  <xs:element name="T013.1_MeterUpdate"
type="MeterUpdateNotificationType"/>
  <xs:element name="T013.3_UpdateMeterLocationNotification"
type="UpdateMeterLocationNotificationType"/>
  <xs:element name="T014.1_MeterUpdateNotification"
type="ChargeableMeterUpdateType"/>
  <xs:element name="T015.1_DisconnectionNotification"
type="DisconnectionType"/>
  <xs:element name="T016.1_UnmeasureableNotification"
type="T016.0_UnmeasureableDeclarationType"/>
  <xs:element name="T017.1_MeterSwapNotification"
type="MeterSwapNotificationType"/>
  <xs:element name="T019.0_WaterSPIDData" type="WaterSPIDDataType"/>
  <xs:element name="T020.0_SewerageSPIDData"
type="SewerageSPIDDataType"/>
  <xs:element name="T021.1_DPIDNotification" type="DPIDNotificationType"/>
  <xs:element name="T022.1_TEUpdateNotification" type="TEUpdateType"/>
  <xs:element name="T023.1_MeterAssociationNotification"
type="MeterAssociationType"/>
  <xs:element name="T024.1_MeterDisAssociationNotification"
type="MeterDisAssociationType"/>
  <xs:element name="T026.1_DiscontinueDPIDNotification"
type="DiscontinueDPIDType"/>
  <xs:element name="T027.1_DPIDUpdateNotification"
type="DPIDUpdateType"/>
  <xs:element name="T028.0_Schedule3UpdateNotification"
type="Schedule3UpdateType"/>
  <xs:element name="T029.0_SpecialArrangementsUpdateNotification"
type="SpecialArrangementsUpdateNotificationType"/>
  <xs:element
name="T029.4_PremisesSpecialArrangementsUpdateNotification"
type="PremisesSpecialArrangementsUpdateNotificationType"/>
  <xs:element name="T030.0_DPMeterReadNotification"
type="DPMeterReadType"/>
  <xs:element name="T030.1_DPMeterReadNotification"
type="DPMeterReadType"/>
  <xs:element name="T032.1_CustomerNameUpdated"
type="T032.1_CustomerNameUpdatedType"/>
  <xs:element name="T032.2_CustomerNameUpdatedNotification"
type="CustomerNameUpdatedNotificationType"/>
  <xs:element name="T033.1_MeteredBuildingUpdate"
type="T033.1_MeteredBuildingUpdate"/>
  <xs:element name="T034.1_VacSchemeGracePeriodNotification"
type="T034.1_VacSchemeGracePeriodNotification"/>
  <xs:element name="T034.2_VacSchemeGraceEndNotification"
type="T034.2_VacSchemeGraceEndNotification"/>
  <xs:element name="T034.3_VacSchemeApplicationNotification"
type="T034.3_VacSchemeApplicationNotification"/>
  <xs:element
name="T034.5_VacSchemeApplicationConfirmationOrCancellationNotification"
type="T034.5_VacSchemeApplicationConfirmationOrCancellationNotification"/>
  <xs:element name="T035.0_TradeabilityNotification"
type="T035.0_TradeabilityNotification"/>
  <xs:element name="T035.1_TradeabilityNotification"
type="T035.1_TradeabilityNotification"/>
  <xs:element name="T036.1_MeterNetworkAssociationNotification"
type="MeterNetworkAssociationType"/>
</xs:choice>

```

```

</xs:sequence>
</xs:complexType>

```

element **ResponseMessagesType/T002.0_NewSPIDNotification**

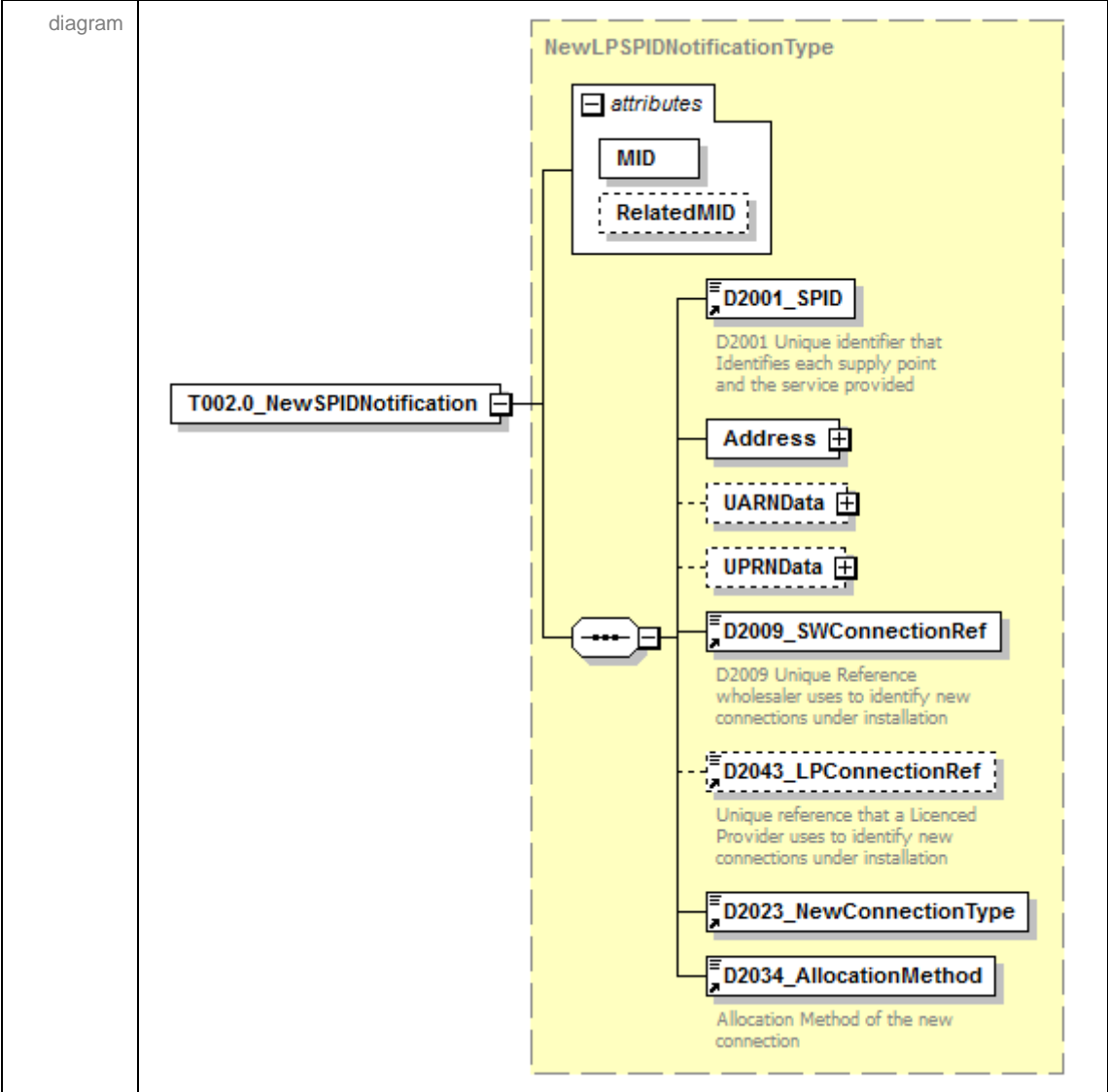

| | | | | | | |
|------------|--------------------------------------------------------------------------------------------------------------------------------------------------------------------------------------------------------------------------------------------------------------------|-------------------------------|----------|---------|-------|------------|
| namespace | urn:bridgeall-com:cmaservice:data:v3 | | | | | |
| type | NewLPSPIDNotificationType | | | | | |
| properties | isRef | 0 | content | complex | | |
| children | D2001_SPID Address UARNDData UPRNDData D2009_SWConnectionRef D2043_LPCConnectionRef D2023_NewConnectionType D2034_AllocationMethod | | | | | |
| attributes | Name | Type | Use | Default | Fixed | annotation |
| | MID | MessageIdType | required | | | |
| | RelatedMID | MessageIdType | optional | | | |
| source | <pre> <xs:element name="T002.0_NewSPIDNotification" type="NewLPSPIDNotificationType"/> </pre> | | | | | |

element **ResponseMessagesType/T002.1_NewSPIDNotification**

| <p>diagram</p> | | | | | | | | | | | | | | | | | | | |
|----------------------------|--------------------------------------------------------------------------------------------------------------------------------------------------------------------------------------------------------------------------------------------------------------------------------------------------------------------------------------------------------------------------------------------------------------------------------------------|----------|---------|-------|------------|-------|------------|---------------------|-------------------------------|----------|--|--|--|----------------------------|-------------------------------|----------|--|--|--|
| <p>namespace</p> | <p>urn:bridgeall-com:cmaservice:data:v3</p> | | | | | | | | | | | | | | | | | | |
| <p>type</p> | <p>NewSPIDNotificationType</p> | | | | | | | | | | | | | | | | | | |
| <p>properties</p> | <p>isRef 0 content complex</p> | | | | | | | | | | | | | | | | | | |
| <p>children</p> | <p>D2001_SPID Address UARNDData UPRNDData D2009_SWConnectionRef D2043_LPCConnectionRef D2023_NewConnectionType D2034_AllocationMethod D4001_OrgId</p> | | | | | | | | | | | | | | | | | | |
| <p>attributes</p> | <table border="1"> <thead> <tr> <th>Name</th> <th>Type</th> <th>Use</th> <th>Default</th> <th>Fixed</th> <th>annotation</th> </tr> </thead> <tbody> <tr> <td>MID</td> <td>MessageIdType</td> <td>required</td> <td></td> <td></td> <td></td> </tr> <tr> <td>RelatedMID</td> <td>MessageIdType</td> <td>optional</td> <td></td> <td></td> <td></td> </tr> </tbody> </table> | Name | Type | Use | Default | Fixed | annotation | MID | MessageIdType | required | | | | RelatedMID | MessageIdType | optional | | | |
| Name | Type | Use | Default | Fixed | annotation | | | | | | | | | | | | | | |
| MID | MessageIdType | required | | | | | | | | | | | | | | | | | |
| RelatedMID | MessageIdType | optional | | | | | | | | | | | | | | | | | |
| <p>source</p> | <p><xs:element name="T002.1_NewSPIDNotification" type="NewSPIDNotificationType"/></p> | | | | | | | | | | | | | | | | | | |

element **ResponseMessagesType/T004.1_NewMeterNotification**

| | |
|------------------|--------------------------------------------------------------------------------------------------------------------------------------------------------------------------------------------------------------------------------------------------------------------------------------------------------------------------------------------------------------------------------------------------------------------------------------------------------------------------------------------------------------------------------------------------------------------------------------------------------------------------------------------------------------------------------------------------------------------------------------------------------------------------------------------------------------------------------------------------------------------------------------------------------------------------------------------------------------------------------------------------------------------------------------------------------------------------------------------------------------------------------------------------------------------------------------------------------------------------------------------------------------------------------------------------------------------------------------------------------------------------------------------------------------------------------------------------------------------------------------------------------------------------------------------------------------------------------------------------------------------------------------------------------------------------------------------------------------------------------------------------------------------------------------------------------------------------------------------------------------------------------------------------------------------------------------------------------------------------------------------------------------------------------------------------------------------------------------------------------------------------------------------------------------------------------------------------------------|
| <p>diagram</p> | <p>The diagram illustrates the structure of the T004.1_NewMeterNotificationType element. It is a complex type containing several attributes and elements. The structure is as follows:</p> <ul style="list-style-type: none"> attributes (group): <ul style="list-style-type: none"> MID (string) RelatedMID (string) D2001_SPID (string): D2001 Unique Identifier that Identifies each supply point and the service provided D3001_MeterId (string): Meter Identification (e.g. manufacturers serial number) D3004_NrDigits (string): The number of digits on the meter register MeterLocation (string) D3003_PhysicalMeterSize (string): Actual size of a meter (mm) D3002_ChargeableMeterSize (string): Meter size for tariff charge calculation purposes (mm) D3005_SewerageChargeableMet... (string): The chargeable size for the Related Water Supply Meter for calculations of Sewerage tariff D3011_MeterReadFrequency (string): The frequency that the LP must read a meter D3007_ReturnToSewerAllowance (string): Return to sewer allowance for a particular meter D3013_MeterMake (string): Meter Make D3014_ManufacturerMeterSerial... (string): Meter Serial Number D2010_YVe (string): Yearly Volumetric Usage Estimate for the SPID D3015_datalogger_SW (boolean): Specifies the presence of a Scottish Water datalogger D3016_datalogger_NonSW (boolean): Specifies the presence of a non Scottish Water datalogger D3017_GISX (string): Specifies the X coordinate of the location of the meter D3018_GISY (string): Specifies the Y coordinate of the location of the meter D3019_GISZFreeDescriptor (string): Specifies the Z Free Descriptor of the location of the meter D3022_MeterTreatment (string): Meter Treatment Indicator D3025_MeterLocationCode (string): Meter Location Code |
| <p>namespace</p> | <p>urn:bridgeall-com:cmaservice:data:v3</p> |
| <p>type</p> | <p>T004.1_NewMeterNotificationType</p> |

| properties | isRef 0 content complex | | | | | | | | | | | | | | | | | | |
|----------------------------|---------------------------------------------------------------------------------------------------------------------------------------------------------------------------------------------------------------------------------------------------------------------------------------------------------------------------------------------------------------------------------------------------------------------------------------------------------------------------------------------------------------------------------------------------------------------------------------------------------------------------------------------------------------------------------------------------------------------------------|----------|---------|-------|------------|-------|------------|---------------------|-------------------------------|----------|--|--|--|----------------------------|-------------------------------|----------|--|--|--|
| children | D2001_SPID D3001_MeterId D3004_NrDigits MeterLocation D3003_PhysicalMeterSize D3002_ChargeableMeterSize D3005_SewerageChargeableMeterSize D3011_MeterReadFrequency D3007_ReturnToSewerAllowance D3013_MeterMake D3014_ManufacturerMeterSerialNr D2010_YVe D3015_datalogger_SW D3016_datalogger_NonSW D3017_GISX D3018_GISY D3019_GISZFreeDescriptor D3022_MeterTreatment D3025_MeterLocationCode | | | | | | | | | | | | | | | | | | |
| attributes | <table border="1"> <thead> <tr> <th>Name</th> <th>Type</th> <th>Use</th> <th>Default</th> <th>Fixed</th> <th>annotation</th> </tr> </thead> <tbody> <tr> <td>MID</td> <td>MessageIdType</td> <td>required</td> <td></td> <td></td> <td></td> </tr> <tr> <td>RelatedMID</td> <td>MessageIdType</td> <td>optional</td> <td></td> <td></td> <td></td> </tr> </tbody> </table> | Name | Type | Use | Default | Fixed | annotation | MID | MessageIdType | required | | | | RelatedMID | MessageIdType | optional | | | |
| Name | Type | Use | Default | Fixed | annotation | | | | | | | | | | | | | | |
| MID | MessageIdType | required | | | | | | | | | | | | | | | | | |
| RelatedMID | MessageIdType | optional | | | | | | | | | | | | | | | | | |
| source | <xs:element name="T004.1_NewMeterNotification" type="T004.1_NewMeterNotificationType"/> | | | | | | | | | | | | | | | | | | |

element **ResponseMessagesType/T005.2_MeterReadNotification**

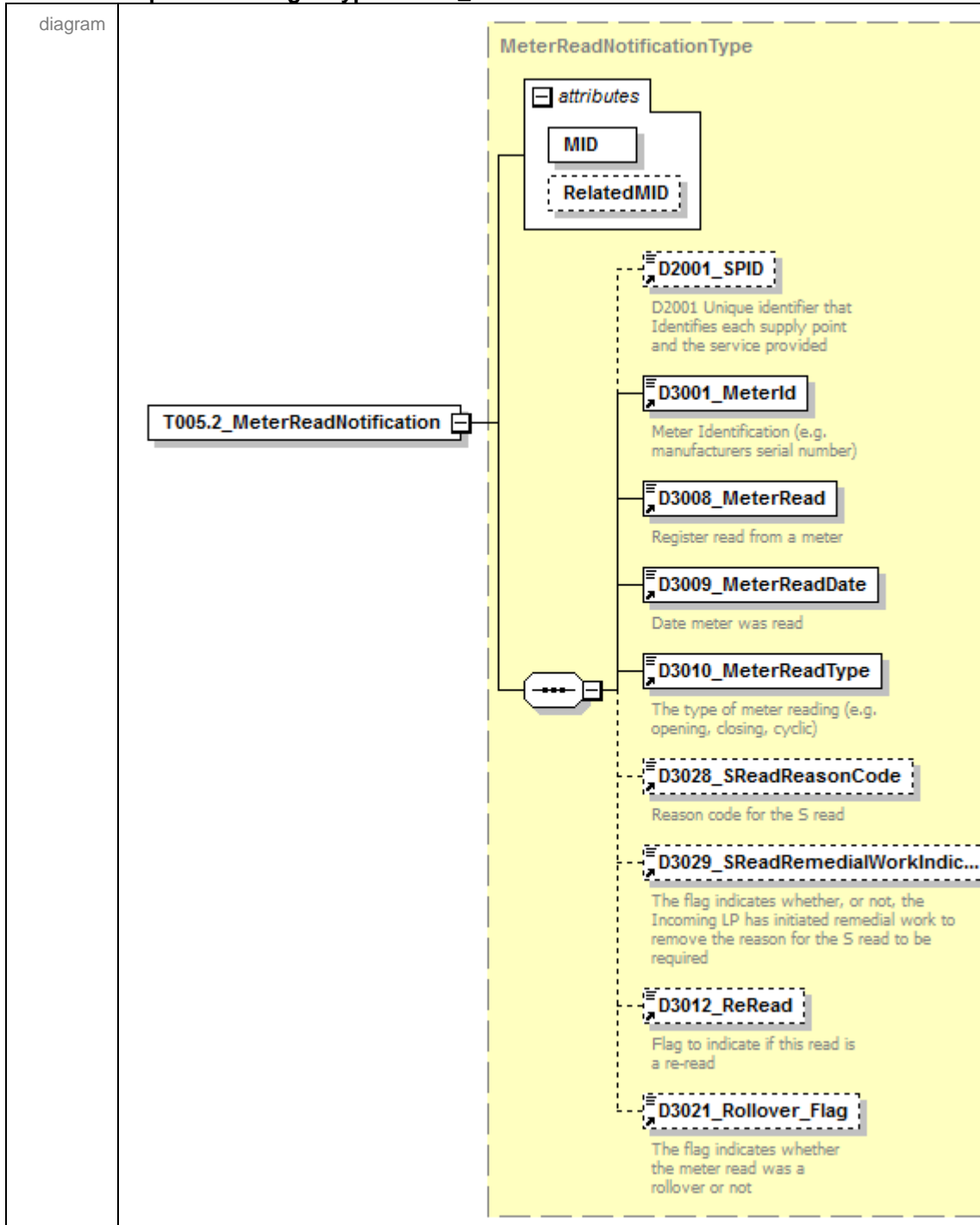

| | | | | | | |
|------------|--------------------------------------------------------------------------------------------------------------------------------------------------------------------------------------------------------------------------------------------------------------------------------------------------------------------------|-------------------------------|----------|---------|-------|------------|
| namespace | urn:bridgeall-com:cmaservice:data:v3 | | | | | |
| type | MeterReadNotificationType | | | | | |
| properties | isRef | 0 | content | complex | | |
| children | D2001_SPID D3001_MeterId D3008_MeterRead D3009_MeterReadDate D3010_MeterReadType D3028_SReadReasonCode D3029_SReadRemedialWorkIndicator D3012_ReRead D3021_Rollover_Flag | | | | | |
| attributes | Name | Type | Use | Default | Fixed | annotation |
| | MID | MessageIdType | required | | | |
| | RelatedMID | MessageIdType | optional | | | |

| | |
|--------|------------------------------------------------------------------------------------|
| source | <xs:element name="T005.2_MeterReadNotification" type="MeterReadNotificationType"/> |
|--------|------------------------------------------------------------------------------------|

element **ResponseMessagesType/T005.3_MeterReadNotification**

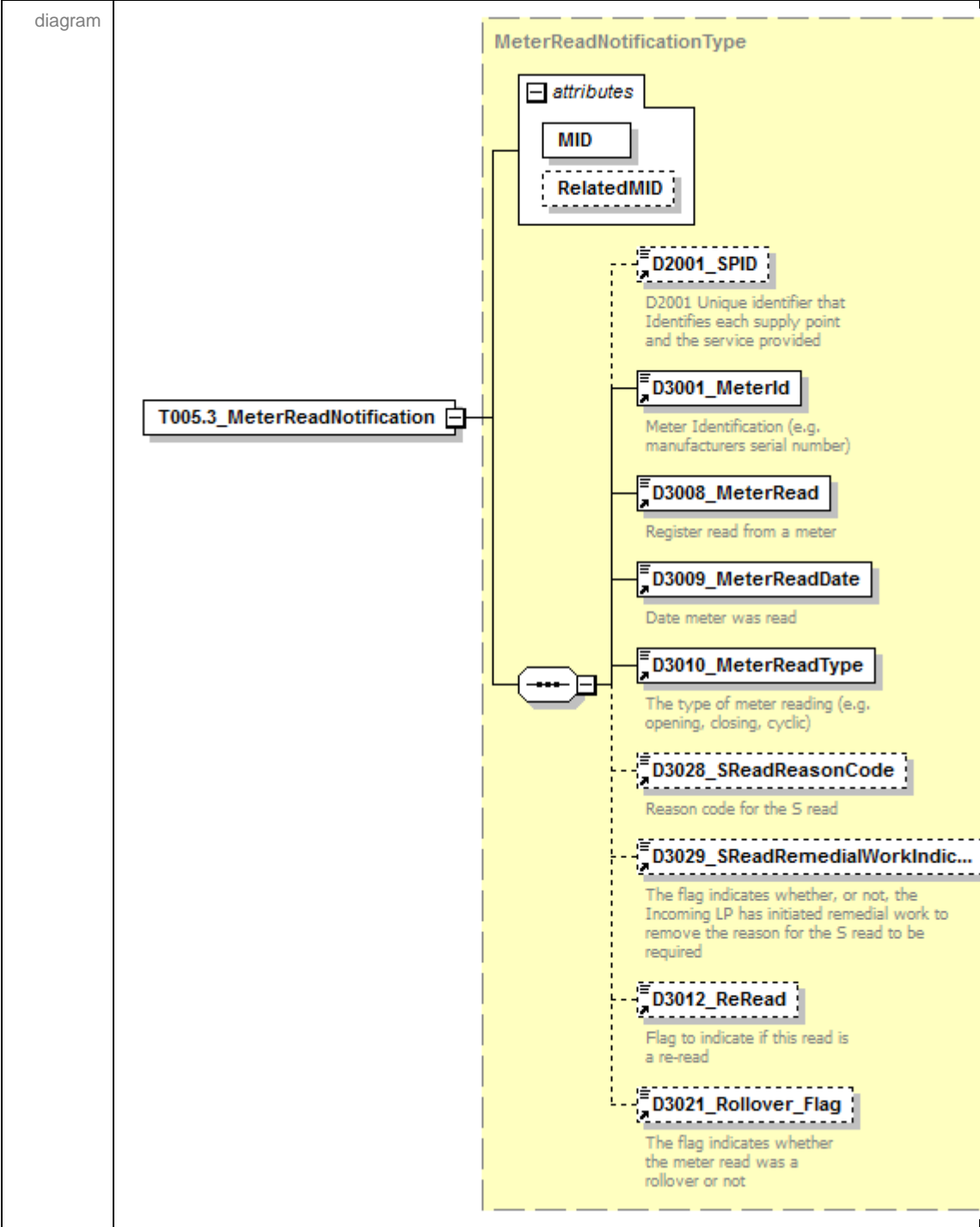

| | |
|------------|------------------------------------------------------------------------------------------------------------------------------------------------------------------|
| namespace | urn:bridgeall-com:cmaservice:data:v3 |
| type | MeterReadNotificationType |
| properties | isRef 0 content complex |
| children | D2001_SPID D3001_MeterId D3008_MeterRead D3009_MeterReadDate D3010_MeterReadType |

| | | | | | | |
|------------|---------------------------------------------------------------------------------------------------------------------------------------------------------|------------------------------------------------------------------------|-----------------------------|---------|-------|------------|
| | D3028_SReadReasonCode D3029_SReadRemedialWorkIndicator D3012_ReRead D3021_Rollover_Flag | | | | | |
| attributes | Name MID RelatedMID | Type MessageIdType MessageIdType | Use required optional | Default | Fixed | annotation |
| source | <xs:element name="T005.3_MeterReadNotification" type="MeterReadNotificationType"/> | | | | | |

element **ResponseMessagesType/T006.4_WaterSPIDNotification**

| | | | | | | |
|------------|---------------------------------------------------------------------------------------------------------------------------------------------------------------------------------------------------------------------------------------------------------------------------------------------------------------------------------------------------------------------------------------------------------------------------------------------------------------------------------------------------------------------------------------------------------------------------------------------------------------------------------------------------------------------------------------------------------------------------------------------------------------------------------------------------------------------------------------------------------------------------------------------------------------------------------------------------|------------------------------------------------------------------------|-----------------------------|---------|-------|------------|
| diagram | <p>The diagram illustrates the structure of the T006.4_WaterSPIDNotificationType element. It is a complex type with the following components:</p> <ul style="list-style-type: none"> Attributes: <ul style="list-style-type: none"> MID: Required, MessageIdType. RelatedMID: Optional, MessageIdType. Children: <ul style="list-style-type: none"> D2001_SPID: Unique identifier that identifies each supply point and the service provided. D2018_TroughsDrinkingBowls: Does SPID have this Service Element (how many). D2020_OutsideTaps: Does SPID have this Service Element (how many). D2011_RateableValue: Rateable Value of Supply Point. D2014_FarmCroft: If Outside Taps or Troughs and Drinking Bowls are True, this must be used to specify farm or croft. | | | | | |
| namespace | urn:bridgeall-com:cmaservice:data:v3 | | | | | |
| type | T006.4_WaterSPIDNotificationType | | | | | |
| properties | isRef 0 content complex | | | | | |
| children | D2001_SPID D2018_TroughsDrinkingBowls D2020_OutsideTaps D2011_RateableValue D2014_FarmCroft | | | | | |
| attributes | Name MID RelatedMID | Type MessageIdType MessageIdType | Use required optional | Default | Fixed | annotation |
| source | <xs:element name="T006.4_WaterSPIDNotification" type="T006.4_WaterSPIDNotificationType"/> | | | | | |

element **ResponseMessagesType/T006.5_SewerageSPIDNotification**

| <p>diagram</p> | <p>The diagram illustrates the structure of the T006.5_SewerageSPIDNotificationType. It consists of a root element T006.5_SewerageSPIDNotification which contains two main parts:</p> <ul style="list-style-type: none"> attributes: A block containing two elements: MID (required) and RelatedMID (optional). Complex Content: A block containing four elements: <ul style="list-style-type: none"> D2001_SPID: D2001 Unique identifier that Identifies each supply point and the service provided. D2016_PropertyDrainage: Does SPID have this Service Element. D2017_RoadDrainage: Does SPID have this Service Element. D2011_RateableValue: Rateable Value of Supply Point. | | | | | | | | | | | | | | | | | | |
|----------------------------|---------------------------------------------------------------------------------------------------------------------------------------------------------------------------------------------------------------------------------------------------------------------------------------------------------------------------------------------------------------------------------------------------------------------------------------------------------------------------------------------------------------------------------------------------------------------------------------------------------------------------------------------------------------------------------------------------------------------------------------------------------------------------------------------------------------------------|----------|---------|-------|------------|-------|------------|---------------------|-------------------------------|----------|--|--|--|----------------------------|-------------------------------|----------|--|--|--|
| <p>namespace</p> | <p>urn:bridgeall-com:cmaservice:data:v3</p> | | | | | | | | | | | | | | | | | | |
| <p>type</p> | <p>T006.5_SewerageSPIDNotificationType</p> | | | | | | | | | | | | | | | | | | |
| <p>properties</p> | <p>isRef 0 content complex</p> | | | | | | | | | | | | | | | | | | |
| <p>children</p> | <p>D2001_SPID D2016_PropertyDrainage D2017_RoadDrainage D2011_RateableValue</p> | | | | | | | | | | | | | | | | | | |
| <p>attributes</p> | <table border="1"> <thead> <tr> <th>Name</th> <th>Type</th> <th>Use</th> <th>Default</th> <th>Fixed</th> <th>annotation</th> </tr> </thead> <tbody> <tr> <td>MID</td> <td>MessageIdType</td> <td>required</td> <td></td> <td></td> <td></td> </tr> <tr> <td>RelatedMID</td> <td>MessageIdType</td> <td>optional</td> <td></td> <td></td> <td></td> </tr> </tbody> </table> | Name | Type | Use | Default | Fixed | annotation | MID | MessageIdType | required | | | | RelatedMID | MessageIdType | optional | | | |
| Name | Type | Use | Default | Fixed | annotation | | | | | | | | | | | | | | |
| MID | MessageIdType | required | | | | | | | | | | | | | | | | | |
| RelatedMID | MessageIdType | optional | | | | | | | | | | | | | | | | | |
| <p>source</p> | <pre><xs:element name="T006.5_SewerageSPIDNotification" type="T006.5_SewerageSPIDNotificationType"/></pre> | | | | | | | | | | | | | | | | | | |

element **ResponseMessagesType/T006.7_ProvideLiveRateableValueNotification**

| | | | | | | |
|------------|--------------------------------------------------------------------------------------------------------------------------------------------|-------------------------------|----------|---------|-------|------------|
| diagram | | | | | | |
| namespace | urn:bridgeall-com:cmaservice:data:v3 | | | | | |
| type | T006.7_ProvideLiveRateableValueNotificationType | | | | | |
| properties | isRef | 0 | | | | |
| | content | complex | | | | |
| children | D2001_SPID D2042_LiveRateableValue | | | | | |
| attributes | Name | Type | Use | Default | Fixed | annotation |
| | MID | MessageIdType | required | | | |
| | RelatedMID | MessageIdType | optional | | | |
| source | <code><xs:element name="T006.7_ProvideLiveRateableValueNotification" type="T006.7_ProvideLiveRateableValueNotificationType"/></code> | | | | | |

element **ResponseMessagesType/T007.2_ConnectionCompleteNotification**

| | | | | | | |
|------------|----------------------------------------|---|--|--|--|--|
| diagram | | | | | | |
| namespace | urn:bridgeall-com:cmaservice:data:v3 | | | | | |
| type | ConnectionCompleteType | | | | | |
| properties | isRef | 0 | | | | |

| | | | | | | |
|------------|-------------------------------------------------------------------------------------------------------------|-------------------------------|----------|---------|-------|------------|
| | content | complex | | | | |
| children | D2001_SPID D2013_ConnectionDate | | | | | |
| attributes | Name | Type | Use | Default | Fixed | annotation |
| | MID | MessageIdType | required | | | |
| | RelatedMID | MessageIdType | optional | | | |
| source | <code><xs:element name="T007.2_ConnectionCompleteNotification" type="ConnectionCompleteType"/></code> | | | | | |

element **ResponseMessagesType/T008.0_TerminationNotification**

| | | | | | | |
|------------|-------------------------------------------------------------------------------------------------------------------------------------------------------------------------------------------------------------------------------------------------------------------------------------------------------------------------------------------------------------------------------------------------------------------------------------------------------------------------------------------------------------------------------------------------------------------------------------------------------------------------|-------------------------------|----------|---------|-------|------------|
| diagram | <p>The diagram illustrates the structure of the T008.0_TerminationNotification element. It is a complex type containing an attributes container with MID (required) and RelatedMID (optional). It also contains a sequence of elements: D2001_SPID (required) and D4002_RegistrationStartDate (required). The D2001_SPID element is described as "D2001 Unique identifier that Identifies each supply point and the service provided". The D4002_RegistrationStartDate element is described as "D4002 Date SPID becomes registered to a Licensed Provider".</p> | | | | | |
| namespace | urn:bridgeall-com:cmaservice:data:v3 | | | | | |
| type | RegistrationStartType | | | | | |
| properties | isRef | 0 | content | complex | | |
| children | D2001_SPID D4002_RegistrationStartDate | | | | | |
| attributes | Name | Type | Use | Default | Fixed | annotation |
| | MID | MessageIdType | required | | | |
| | RelatedMID | MessageIdType | optional | | | |
| source | <code><xs:element name="T008.0_TerminationNotification" type="RegistrationStartType"/></code> | | | | | |

element **ResponseMessagesType/T008.1_RegistrationConfirmation**

| diagram | | | | | | | | | | | | | | | | | | | |
|----------------------------|--------------------------------------------------------------------------------------------------------------------------------------------------------------------------------------------------------------------------------------------------------------------------------------------------------------------------------------------------------------------------------------------------------------------------------------------|----------|---------|-------|------------|-------|------------|---------------------|-------------------------------|----------|--|--|--|----------------------------|-------------------------------|----------|--|--|--|
| namespace | urn:bridgeall-com:cmaservice:data:v3 | | | | | | | | | | | | | | | | | | |
| type | RegistrationStartType | | | | | | | | | | | | | | | | | | |
| properties | isRef 0 content complex | | | | | | | | | | | | | | | | | | |
| children | D2001_SPID D4002_RegistrationStartDate | | | | | | | | | | | | | | | | | | |
| attributes | <table border="1"> <thead> <tr> <th>Name</th> <th>Type</th> <th>Use</th> <th>Default</th> <th>Fixed</th> <th>annotation</th> </tr> </thead> <tbody> <tr> <td>MID</td> <td>MessageIdType</td> <td>required</td> <td></td> <td></td> <td></td> </tr> <tr> <td>RelatedMID</td> <td>MessageIdType</td> <td>optional</td> <td></td> <td></td> <td></td> </tr> </tbody> </table> | Name | Type | Use | Default | Fixed | annotation | MID | MessageIdType | required | | | | RelatedMID | MessageIdType | optional | | | |
| Name | Type | Use | Default | Fixed | annotation | | | | | | | | | | | | | | |
| MID | MessageIdType | required | | | | | | | | | | | | | | | | | |
| RelatedMID | MessageIdType | optional | | | | | | | | | | | | | | | | | |
| source | <pre><xs:element name="T008.1_RegistrationConfirmation" type="RegistrationStartType"/></pre> | | | | | | | | | | | | | | | | | | |

element **ResponseMessagesType/T008.2_NotifyRSD**

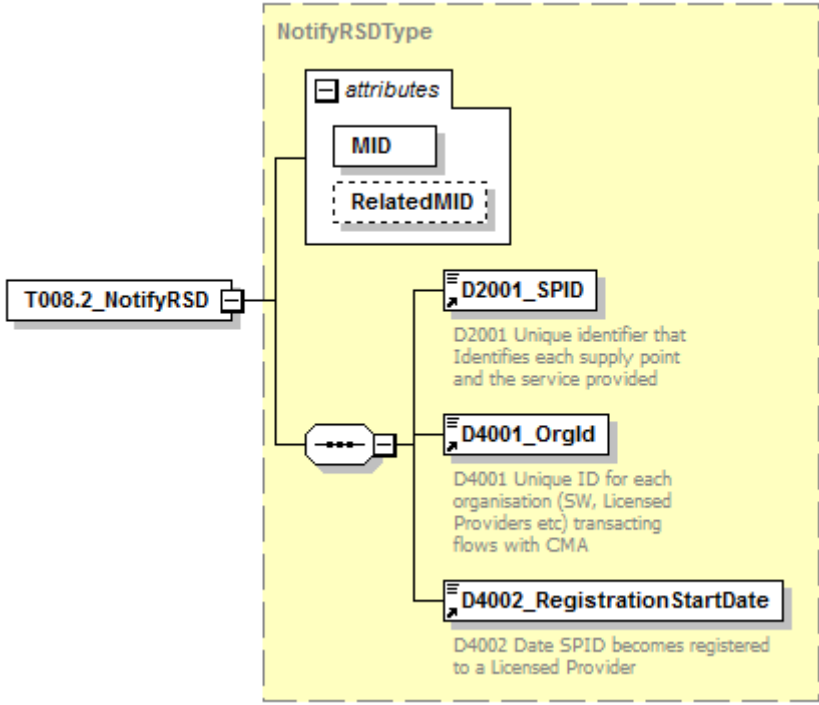
| diagram |  | | | | | | | | | | | | | | | | | | |
|----------------------------|--------------------------------------------------------------------------------------------------------------------------------------------------------------------------------------------------------------------------------------------------------------------------------------------------------------------------------------------------------------------------------------------------------------------------------------------|----------|---------|-------|------------|-------|------------|---------------------|-------------------------------|----------|--|--|--|----------------------------|-------------------------------|----------|--|--|--|
| namespace | urn:bridgeall-com:cmaservice:data:v3 | | | | | | | | | | | | | | | | | | |
| type | NotifyRSDType | | | | | | | | | | | | | | | | | | |
| properties | isRef 0 content complex | | | | | | | | | | | | | | | | | | |
| children | D2001_SPID D4001_OrgId D4002_RegistrationStartDate | | | | | | | | | | | | | | | | | | |
| attributes | <table border="1"> <thead> <tr> <th>Name</th> <th>Type</th> <th>Use</th> <th>Default</th> <th>Fixed</th> <th>annotation</th> </tr> </thead> <tbody> <tr> <td>MID</td> <td>MessageIdType</td> <td>required</td> <td></td> <td></td> <td></td> </tr> <tr> <td>RelatedMID</td> <td>MessageIdType</td> <td>optional</td> <td></td> <td></td> <td></td> </tr> </tbody> </table> | Name | Type | Use | Default | Fixed | annotation | MID | MessageIdType | required | | | | RelatedMID | MessageIdType | optional | | | |
| Name | Type | Use | Default | Fixed | annotation | | | | | | | | | | | | | | |
| MID | MessageIdType | required | | | | | | | | | | | | | | | | | |
| RelatedMID | MessageIdType | optional | | | | | | | | | | | | | | | | | |
| source | <xs:element name="T008.2_NotifyRSD" type="NotifyRSDType"/> | | | | | | | | | | | | | | | | | | |

element **ResponseMessagesType/T009.0_Notification**

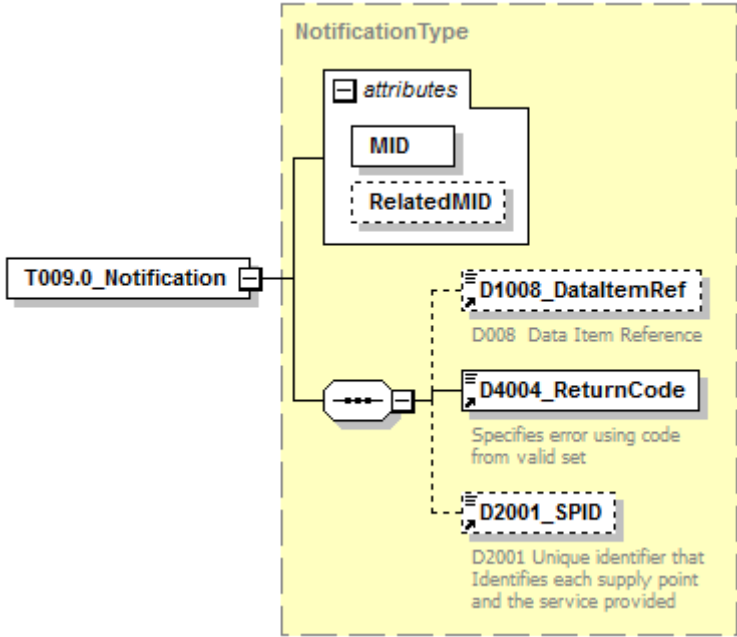
| diagram |  | | | | | | | | | | | | | | | | | | |
|----------------------------|--------------------------------------------------------------------------------------------------------------------------------------------------------------------------------------------------------------------------------------------------------------------------------------------------------------------------------------------------------------------------------------------------------------------------------------------|----------|---------|-------|------------|-------|------------|---------------------|-------------------------------|----------|--|--|--|----------------------------|-------------------------------|----------|--|--|--|
| namespace | urn:bridgeall-com:cmaservice:data:v3 | | | | | | | | | | | | | | | | | | |
| type | NotificationType | | | | | | | | | | | | | | | | | | |
| properties | isRef 0 content complex | | | | | | | | | | | | | | | | | | |
| children | D1008_DataItemRef D4004_ReturnCode D2001_SPID | | | | | | | | | | | | | | | | | | |
| attributes | <table border="1"> <thead> <tr> <th>Name</th> <th>Type</th> <th>Use</th> <th>Default</th> <th>Fixed</th> <th>annotation</th> </tr> </thead> <tbody> <tr> <td>MID</td> <td>MessageIdType</td> <td>required</td> <td></td> <td></td> <td></td> </tr> <tr> <td>RelatedMID</td> <td>MessageIdType</td> <td>optional</td> <td></td> <td></td> <td></td> </tr> </tbody> </table> | Name | Type | Use | Default | Fixed | annotation | MID | MessageIdType | required | | | | RelatedMID | MessageIdType | optional | | | |
| Name | Type | Use | Default | Fixed | annotation | | | | | | | | | | | | | | |
| MID | MessageIdType | required | | | | | | | | | | | | | | | | | |
| RelatedMID | MessageIdType | optional | | | | | | | | | | | | | | | | | |
| source | <code><xs:element name="T009.0_Notification" type="NotificationType"/></code> | | | | | | | | | | | | | | | | | | |

element **ResponseMessagesType/T009.1_Notification**

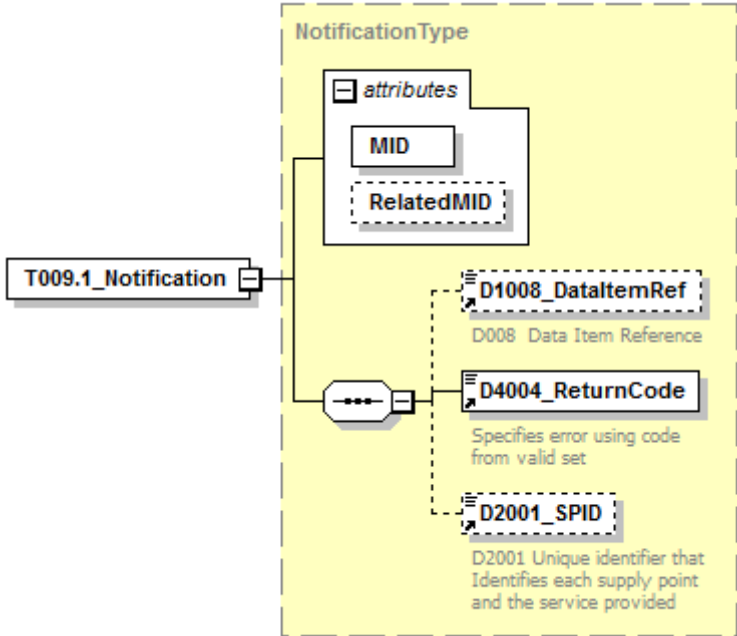
| | |
|---------|--------------------------------------------------------------------------------------|
| diagram |  |
|---------|--------------------------------------------------------------------------------------|

| | | | | | | |
|------------|-----------------------------------------------------------------------------------------------|-------------------------------|----------|---------|-------|------------|
| namespace | urn:bridgeall-com:cmaservice:data:v3 | | | | | |
| type | NotificationType | | | | | |
| properties | isRef | 0 | | | | |
| | content | complex | | | | |
| children | D1008 DataItemRef D4004 ReturnCode D2001 SPID | | | | | |
| attributes | Name | Type | Use | Default | Fixed | annotation |
| | MID | MessageIDType | required | | | |
| | RelatedMID | MessageIDType | optional | | | |
| source | <xs:element name="T009.1_Notification" type="NotificationType"/> | | | | | |

element **ResponseMessageType/T009.4_Notification**

| | | | | | | |
|------------|---------------------------------------------------------------------------|-------------------------------|----------|---------|-------|------------|
| diagram | | | | | | |
| namespace | urn:bridgeall-com:cmaservice:data:v3 | | | | | |
| type | T009.4_NotificationType | | | | | |
| properties | isRef | 0 | | | | |
| | content | complex | | | | |
| children | D1009 DuplicateMessageID D4004 ReturnCode | | | | | |
| attributes | Name | Type | Use | Default | Fixed | annotation |
| | MID | MessageIDType | required | | | |
| | RelatedMID | MessageIDType | optional | | | |
| source | <xs:element name="T009.4_Notification" type="T009.4_NotificationType"/> | | | | | |

element **ResponseMessageType/T011.0_CancelRegistrationNotificationIncoming**

| diagram | | | | | | | | | | | | | | | | | | | |
|----------------------------|--------------------------------------------------------------------------------------------------------------------------------------------------------------------------------------------------------------------------------------------------------------------------------------------------------------------------------------------------------------------------------------------------------------------------------------------|----------|---------|-------|------------|-------|------------|---------------------|-------------------------------|----------|--|--|--|----------------------------|-------------------------------|----------|--|--|--|
| namespace | urn:bridgeall-com:cmaservice:data:v3 | | | | | | | | | | | | | | | | | | |
| type | CancelRegistrationNotificationType | | | | | | | | | | | | | | | | | | |
| properties | isRef 0 content complex | | | | | | | | | | | | | | | | | | |
| children | D2001_SPID D4003_Comment D4005_CancellationCode | | | | | | | | | | | | | | | | | | |
| attributes | <table border="1"> <thead> <tr> <th>Name</th> <th>Type</th> <th>Use</th> <th>Default</th> <th>Fixed</th> <th>annotation</th> </tr> </thead> <tbody> <tr> <td>MID</td> <td>MessageIdType</td> <td>required</td> <td></td> <td></td> <td></td> </tr> <tr> <td>RelatedMID</td> <td>MessageIdType</td> <td>optional</td> <td></td> <td></td> <td></td> </tr> </tbody> </table> | Name | Type | Use | Default | Fixed | annotation | MID | MessageIdType | required | | | | RelatedMID | MessageIdType | optional | | | |
| Name | Type | Use | Default | Fixed | annotation | | | | | | | | | | | | | | |
| MID | MessageIdType | required | | | | | | | | | | | | | | | | | |
| RelatedMID | MessageIdType | optional | | | | | | | | | | | | | | | | | |
| source | <xs:element name="T011.0_CancelRegistrationNotificationIncoming" type="CancelRegistrationNotificationType"/> | | | | | | | | | | | | | | | | | | |

element **ResponseMessageType/T011.1_CancelRegistrationNotificationOutgoing**

| | |
|-----------|-------------------------------------------------------|
| diagram | |
| namespace | urn:bridgeall-com:cmaservice:data:v3 |
| type | CancelRegistrationNotificationOutType |

| properties | isRef 0 content complex | | | | | | | | | | | | | | | | | | |
|----------------------------|--------------------------------------------------------------------------------------------------------------------------------------------------------------------------------------------------------------------------------------------------------------------------------------------------------------------------------------------------------------------------------------------------------------------------------------------|----------|---------|-------|------------|-------|------------|---------------------|-------------------------------|----------|--|--|--|----------------------------|-------------------------------|----------|--|--|--|
| children | D2001_SPID | | | | | | | | | | | | | | | | | | |
| attributes | <table border="1"> <thead> <tr> <th>Name</th> <th>Type</th> <th>Use</th> <th>Default</th> <th>Fixed</th> <th>annotation</th> </tr> </thead> <tbody> <tr> <td>MID</td> <td>MessageIdType</td> <td>required</td> <td></td> <td></td> <td></td> </tr> <tr> <td>RelatedMID</td> <td>MessageIdType</td> <td>optional</td> <td></td> <td></td> <td></td> </tr> </tbody> </table> | Name | Type | Use | Default | Fixed | annotation | MID | MessageIdType | required | | | | RelatedMID | MessageIdType | optional | | | |
| Name | Type | Use | Default | Fixed | annotation | | | | | | | | | | | | | | |
| MID | MessageIdType | required | | | | | | | | | | | | | | | | | |
| RelatedMID | MessageIdType | optional | | | | | | | | | | | | | | | | | |
| source | <code><xs:element name="T011.1_CancelRegistrationNotificationOutgoing" type="CancelRegistrationNotificationOutType"/></code> | | | | | | | | | | | | | | | | | | |

element **ResponseMessagesType/T012.2_ServiceElementUpdateNotification**

| diagram | | | | | | | | | | | | | | | | | | | |
|----------------------------|--------------------------------------------------------------------------------------------------------------------------------------------------------------------------------------------------------------------------------------------------------------------------------------------------------------------------------------------------------------------------------------------------------------------------------------------|----------|---------|-------|------------|-------|------------|---------------------|-------------------------------|----------|--|--|--|----------------------------|-------------------------------|----------|--|--|--|
| namespace | urn:bridgeall-com:cmaservice:data:v3 | | | | | | | | | | | | | | | | | | |
| type | ServiceElementUpdateNotificationType | | | | | | | | | | | | | | | | | | |
| properties | isRef 0 content complex | | | | | | | | | | | | | | | | | | |
| children | D2001_SPID D2015_SPIDVacant D4006_EffectiveFrom D4003_Comment | | | | | | | | | | | | | | | | | | |
| attributes | <table border="1"> <thead> <tr> <th>Name</th> <th>Type</th> <th>Use</th> <th>Default</th> <th>Fixed</th> <th>annotation</th> </tr> </thead> <tbody> <tr> <td>MID</td> <td>MessageIdType</td> <td>required</td> <td></td> <td></td> <td></td> </tr> <tr> <td>RelatedMID</td> <td>MessageIdType</td> <td>optional</td> <td></td> <td></td> <td></td> </tr> </tbody> </table> | Name | Type | Use | Default | Fixed | annotation | MID | MessageIdType | required | | | | RelatedMID | MessageIdType | optional | | | |
| Name | Type | Use | Default | Fixed | annotation | | | | | | | | | | | | | | |
| MID | MessageIdType | required | | | | | | | | | | | | | | | | | |
| RelatedMID | MessageIdType | optional | | | | | | | | | | | | | | | | | |
| source | <code><xs:element name="T012.2_ServiceElementUpdateNotification" type="ServiceElementUpdateNotificationType"/></code> | | | | | | | | | | | | | | | | | | |

element **ResponseMessagesType/T012.4_SewerageServiceElementUpdateNotification**

| <p>diagram</p> | | | | | | | | | | | | | | | | | | | |
|----------------------------|--------------------------------------------------------------------------------------------------------------------------------------------------------------------------------------------------------------------------------------------------------------------------------------------------------------------------------------------------------------------------------------------------------------------------------------------|----------|---------|-------|------------|-------|------------|---------------------|-------------------------------|----------|--|--|--|----------------------------|-------------------------------|----------|--|--|--|
| <p>namespace</p> | <p>urn:bridgeall-com:cmaservice:data:v3</p> | | | | | | | | | | | | | | | | | | |
| <p>type</p> | <p>SewerageServiceElementUpdateNotificationType</p> | | | | | | | | | | | | | | | | | | |
| <p>properties</p> | <p>isRef 0 content complex</p> | | | | | | | | | | | | | | | | | | |
| <p>children</p> | <p>D2001_SPID D4006_EffectiveFrom D2016_PropertyDrainage D2017_RoadDrainage D4003_Comment</p> | | | | | | | | | | | | | | | | | | |
| <p>attributes</p> | <table border="1"> <thead> <tr> <th>Name</th> <th>Type</th> <th>Use</th> <th>Default</th> <th>Fixed</th> <th>annotation</th> </tr> </thead> <tbody> <tr> <td>MID</td> <td>MessageIdType</td> <td>required</td> <td></td> <td></td> <td></td> </tr> <tr> <td>RelatedMID</td> <td>MessageIdType</td> <td>optional</td> <td></td> <td></td> <td></td> </tr> </tbody> </table> | Name | Type | Use | Default | Fixed | annotation | MID | MessageIdType | required | | | | RelatedMID | MessageIdType | optional | | | |
| Name | Type | Use | Default | Fixed | annotation | | | | | | | | | | | | | | |
| MID | MessageIdType | required | | | | | | | | | | | | | | | | | |
| RelatedMID | MessageIdType | optional | | | | | | | | | | | | | | | | | |
| <p>source</p> | <pre><xs:element name="T012.4_SewerageServiceElementUpdateNotification" type="SewerageServiceElementUpdateNotificationType"/></pre> | | | | | | | | | | | | | | | | | | |

element

ResponseMessageType/T012.6_UpdateSAAReferenceNumberUPRNNotification

| <p>diagram</p> | | | | | | | | | | | | | | | | | | | |
|----------------------------|------------------------------------------------------------------------------------------------------------------------------------------------------------------------------------------------------------------------------------------------------------------------------------------------------------------------------------------------------------------------------------------------------------------------------------------|----------|---------|-------|------------|-------|------------|---------------------|------------------------------|----------|--|--|--|----------------------------|------------------------------|----------|--|--|--|
| <p>namespa ce</p> | <p>urn:bridgeall-com:cmaservice:data:v3</p> | | | | | | | | | | | | | | | | | | |
| <p>type</p> | <p>UpdateSAAReferenceNumberUPRNNotificationType</p> | | | | | | | | | | | | | | | | | | |
| <p>properties</p> | <p>isRef 0 content complex</p> | | | | | | | | | | | | | | | | | | |
| <p>children</p> | <p>D2001_SPID UARNDData UPRNDData</p> | | | | | | | | | | | | | | | | | | |
| <p>attributes</p> | <table border="1"> <thead> <tr> <th>Name</th> <th>Type</th> <th>Use</th> <th>Default</th> <th>Fixed</th> <th>annotation</th> </tr> </thead> <tbody> <tr> <td>MID</td> <td>MessagedType</td> <td>required</td> <td></td> <td></td> <td></td> </tr> <tr> <td>RelatedMID</td> <td>MessagedType</td> <td>optional</td> <td></td> <td></td> <td></td> </tr> </tbody> </table> | Name | Type | Use | Default | Fixed | annotation | MID | MessagedType | required | | | | RelatedMID | MessagedType | optional | | | |
| Name | Type | Use | Default | Fixed | annotation | | | | | | | | | | | | | | |
| MID | MessagedType | required | | | | | | | | | | | | | | | | | |
| RelatedMID | MessagedType | optional | | | | | | | | | | | | | | | | | |
| <p>source</p> | <pre><xs:element name="T012.6_UpdateSAAReferenceNumberUPRNNotification" type="UpdateSAAReferenceNumberUPRNNotificationType"/></pre> | | | | | | | | | | | | | | | | | | |

element **ResponseMessagesType/T012.8_UpdateLiveRateableValueNotification**

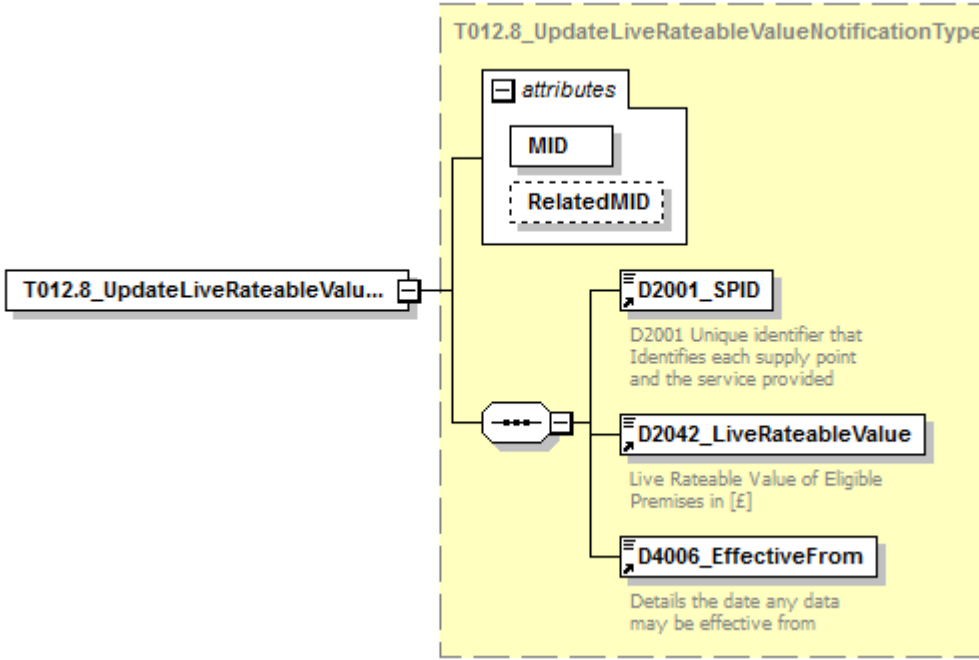
| <p>diagram</p> |  | | | | | | | | | | | | | | | | | | |
|----------------------------|--------------------------------------------------------------------------------------------------------------------------------------------------------------------------------------------------------------------------------------------------------------------------------------------------------------------------------------------------------------------------------------------------------------------------------------------|----------|---------|-------|------------|-------|------------|---------------------|-------------------------------|----------|--|--|--|----------------------------|-------------------------------|----------|--|--|--|
| <p>namespace</p> | <p>urn:bridgeall-com:cmaservice:data:v3</p> | | | | | | | | | | | | | | | | | | |
| <p>type</p> | <p>T012.8_UpdateLiveRateableValueNotificationType</p> | | | | | | | | | | | | | | | | | | |
| <p>properties</p> | <p>isRef 0 content complex</p> | | | | | | | | | | | | | | | | | | |
| <p>children</p> | <p>D2001_SPID D2042_LiveRateableValue D4006_EffectiveFrom</p> | | | | | | | | | | | | | | | | | | |
| <p>attributes</p> | <table border="1"> <thead> <tr> <th>Name</th> <th>Type</th> <th>Use</th> <th>Default</th> <th>Fixed</th> <th>annotation</th> </tr> </thead> <tbody> <tr> <td>MID</td> <td>MessageIdType</td> <td>required</td> <td></td> <td></td> <td></td> </tr> <tr> <td>RelatedMID</td> <td>MessageIdType</td> <td>optional</td> <td></td> <td></td> <td></td> </tr> </tbody> </table> | Name | Type | Use | Default | Fixed | annotation | MID | MessageIdType | required | | | | RelatedMID | MessageIdType | optional | | | |
| Name | Type | Use | Default | Fixed | annotation | | | | | | | | | | | | | | |
| MID | MessageIdType | required | | | | | | | | | | | | | | | | | |
| RelatedMID | MessageIdType | optional | | | | | | | | | | | | | | | | | |
| <p>source</p> | <pre><xs:element name="T012.8_UpdateLiveRateableValueNotification" type="T012.8_UpdateLiveRateableValueNotificationType"/></pre> | | | | | | | | | | | | | | | | | | |

element **ResponseMessagesType/T013.1_MeterUpdate**

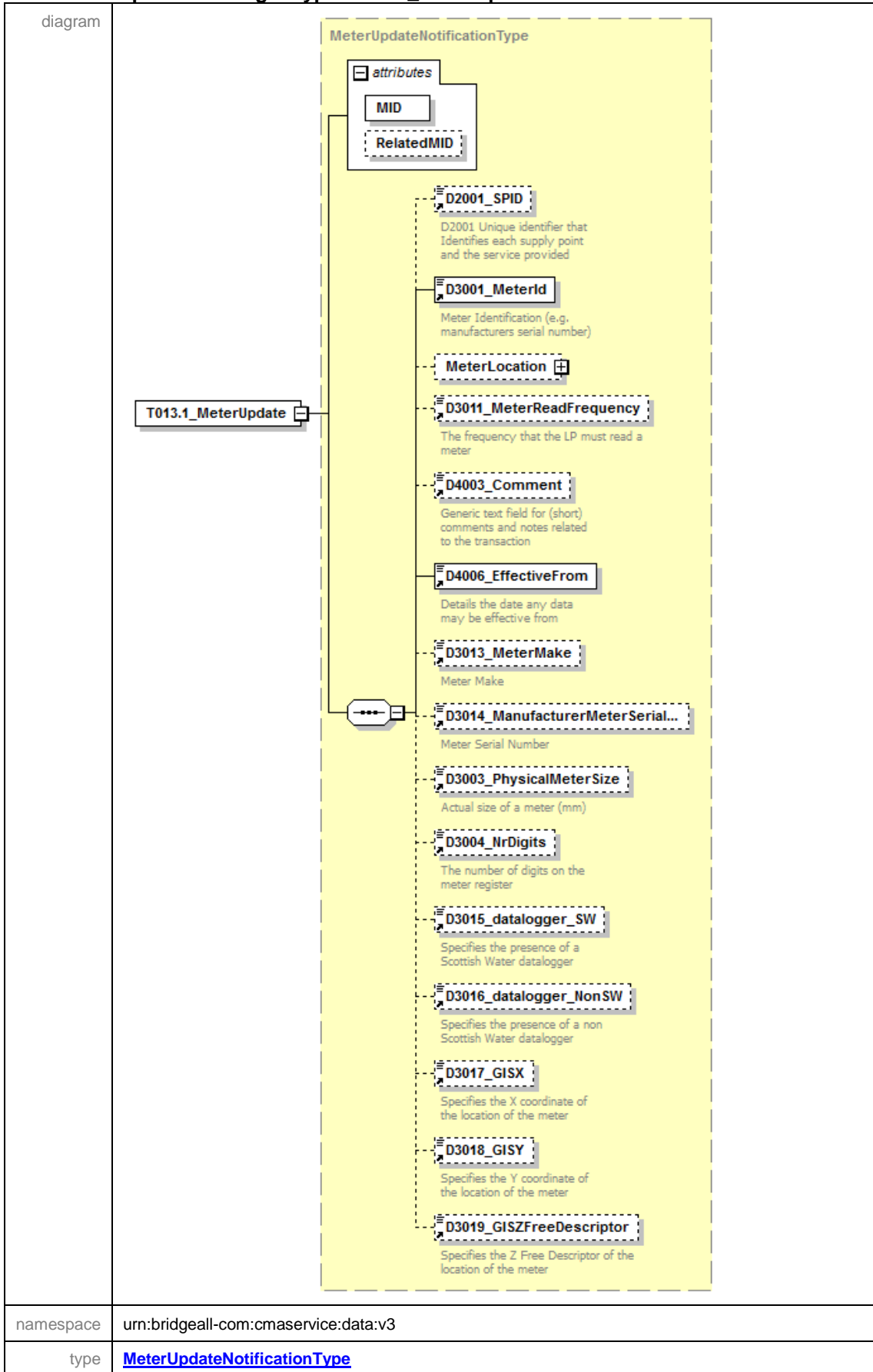

| properties | isRef 0 content complex | | | | | | | | | | | | | | | | | | |
|----------------------------|------------------------------------------------------------------------------------------------------------------------------------------------------------------------------------------------------------------------------------------------------------------------------------------------------------------------------------------------------------------------------------------------------------------------------------------------------------------------------------------------------------------------------------|----------|---------|-------|------------|-------|------------|---------------------|-------------------------------|----------|--|--|--|----------------------------|-------------------------------|----------|--|--|--|
| children | D2001_SPID D3001_MeterId MeterLocation D3011_MeterReadFrequency D4003_Comment D4006_EffectiveFrom D3013_MeterMake D3014_ManufacturerMeterSerialNr D3003_PhysicalMeterSize D3004_NrDigits D3015_datalogger_SW D3016_datalogger_NonSW D3017_GISX D3018_GISY D3019_GISZFreeDescriptor | | | | | | | | | | | | | | | | | | |
| attributes | <table border="1"> <thead> <tr> <th>Name</th> <th>Type</th> <th>Use</th> <th>Default</th> <th>Fixed</th> <th>annotation</th> </tr> </thead> <tbody> <tr> <td>MID</td> <td>MessageIdType</td> <td>required</td> <td></td> <td></td> <td></td> </tr> <tr> <td>RelatedMID</td> <td>MessageIdType</td> <td>optional</td> <td></td> <td></td> <td></td> </tr> </tbody> </table> | Name | Type | Use | Default | Fixed | annotation | MID | MessageIdType | required | | | | RelatedMID | MessageIdType | optional | | | |
| Name | Type | Use | Default | Fixed | annotation | | | | | | | | | | | | | | |
| MID | MessageIdType | required | | | | | | | | | | | | | | | | | |
| RelatedMID | MessageIdType | optional | | | | | | | | | | | | | | | | | |
| source | <code><xs:element name="T013.1_MeterUpdate" type="MeterUpdateNotificationType"/></code> | | | | | | | | | | | | | | | | | | |

element ResponseMessagesType/T013.3_UpdateMeterLocationNotification

| diagram | | | | | | | | | | | | | | | | | | | |
|----------------------------|--------------------------------------------------------------------------------------------------------------------------------------------------------------------------------------------------------------------------------------------------------------------------------------------------------------------------------------------------------------------------------------------------------------------------------------------|----------|---------|-------|------------|-------|------------|---------------------|-------------------------------|----------|--|--|--|----------------------------|-------------------------------|----------|--|--|--|
| namespace | urn:bridgeall-com:cmaservice:data:v3 | | | | | | | | | | | | | | | | | | |
| type | UpdateMeterLocationNotificationType | | | | | | | | | | | | | | | | | | |
| properties | isRef 0 content complex | | | | | | | | | | | | | | | | | | |
| children | D2001_SPID D3001_MeterId D3019_GISZFreeDescriptor D3025_MeterLocationCode | | | | | | | | | | | | | | | | | | |
| attributes | <table border="1"> <thead> <tr> <th>Name</th> <th>Type</th> <th>Use</th> <th>Default</th> <th>Fixed</th> <th>annotation</th> </tr> </thead> <tbody> <tr> <td>MID</td> <td>MessageIdType</td> <td>required</td> <td></td> <td></td> <td></td> </tr> <tr> <td>RelatedMID</td> <td>MessageIdType</td> <td>optional</td> <td></td> <td></td> <td></td> </tr> </tbody> </table> | Name | Type | Use | Default | Fixed | annotation | MID | MessageIdType | required | | | | RelatedMID | MessageIdType | optional | | | |
| Name | Type | Use | Default | Fixed | annotation | | | | | | | | | | | | | | |
| MID | MessageIdType | required | | | | | | | | | | | | | | | | | |
| RelatedMID | MessageIdType | optional | | | | | | | | | | | | | | | | | |
| source | <code><xs:element name="T013.3_UpdateMeterLocationNotification" type="UpdateMeterLocationNotificationType"/></code> | | | | | | | | | | | | | | | | | | |

element **ResponseMessagesType/T014.1_MeterUpdateNotification**

| <p>diagram</p> | | | | | | | | | | | | | | | | | | | |
|----------------------------|--------------------------------------------------------------------------------------------------------------------------------------------------------------------------------------------------------------------------------------------------------------------------------------------------------------------------------------------------------------------------------------------------------------------------------------------|----------|---------|-------|------------|-------|------------|---------------------|-------------------------------|----------|--|--|--|----------------------------|-------------------------------|----------|--|--|--|
| <p>namespace</p> | <p>urn:bridgeall-com:cmaservice:data:v3</p> | | | | | | | | | | | | | | | | | | |
| <p>type</p> | <p>ChargeableMeterUpdateType</p> | | | | | | | | | | | | | | | | | | |
| <p>properties</p> | <p>isRef 0 content complex</p> | | | | | | | | | | | | | | | | | | |
| <p>children</p> | <p>D2001_SPID D3001_MeterId D3002_ChargeableMeterSize D3005_SewerageChargeableMeterSize D4003_Comment D3007_ReturnToSewerAllowance D4006_EffectiveFrom</p> | | | | | | | | | | | | | | | | | | |
| <p>attributes</p> | <table border="1"> <thead> <tr> <th>Name</th> <th>Type</th> <th>Use</th> <th>Default</th> <th>Fixed</th> <th>annotation</th> </tr> </thead> <tbody> <tr> <td>MID</td> <td>MessageIdType</td> <td>required</td> <td></td> <td></td> <td></td> </tr> <tr> <td>RelatedMID</td> <td>MessageIdType</td> <td>optional</td> <td></td> <td></td> <td></td> </tr> </tbody> </table> | Name | Type | Use | Default | Fixed | annotation | MID | MessageIdType | required | | | | RelatedMID | MessageIdType | optional | | | |
| Name | Type | Use | Default | Fixed | annotation | | | | | | | | | | | | | | |
| MID | MessageIdType | required | | | | | | | | | | | | | | | | | |
| RelatedMID | MessageIdType | optional | | | | | | | | | | | | | | | | | |
| <p>source</p> | <pre><xs:element name="T014.1_MeterUpdateNotification" type="ChargeableMeterUpdateType"/></pre> | | | | | | | | | | | | | | | | | | |

element **ResponseMessagesType/T015.1_DisconnectionNotification**

| <p>diagram</p> | | | | | | | | | | | | | | | | | | | |
|----------------------------|--------------------------------------------------------------------------------------------------------------------------------------------------------------------------------------------------------------------------------------------------------------------------------------------------------------------------------------------------------------------------------------------------------------------------------------------|----------|---------|-------|------------|-------|------------|---------------------|-------------------------------|----------|--|--|--|----------------------------|-------------------------------|----------|--|--|--|
| <p>namespace</p> | <p>urn:bridgeall-com:cmaservice:data:v3</p> | | | | | | | | | | | | | | | | | | |
| <p>type</p> | <p>DisconnectionType</p> | | | | | | | | | | | | | | | | | | |
| <p>properties</p> | <p>isRef 0 content complex</p> | | | | | | | | | | | | | | | | | | |
| <p>children</p> | <p>D2001_SPID D4006_EffectiveFrom D2025_DisconnectionReconnection</p> | | | | | | | | | | | | | | | | | | |
| <p>attributes</p> | <table border="1"> <thead> <tr> <th>Name</th> <th>Type</th> <th>Use</th> <th>Default</th> <th>Fixed</th> <th>annotation</th> </tr> </thead> <tbody> <tr> <td>MID</td> <td>MessageIdType</td> <td>required</td> <td></td> <td></td> <td></td> </tr> <tr> <td>RelatedMID</td> <td>MessageIdType</td> <td>optional</td> <td></td> <td></td> <td></td> </tr> </tbody> </table> | Name | Type | Use | Default | Fixed | annotation | MID | MessageIdType | required | | | | RelatedMID | MessageIdType | optional | | | |
| Name | Type | Use | Default | Fixed | annotation | | | | | | | | | | | | | | |
| MID | MessageIdType | required | | | | | | | | | | | | | | | | | |
| RelatedMID | MessageIdType | optional | | | | | | | | | | | | | | | | | |
| <p>source</p> | <pre><xs:element name="T015.1_DisconnectionNotification" type="DisconnectionType"/></pre> | | | | | | | | | | | | | | | | | | |

element **ResponseMessagesType/T016.1_UnmeasureableNotification**

| <p>diagram</p> | | | | | | | | | | | | | | | | | | | |
|----------------------------|--------------------------------------------------------------------------------------------------------------------------------------------------------------------------------------------------------------------------------------------------------------------------------------------------------------------------------------------------------------------------------------------------------------------------------------------|----------|---------|-------|------------|-------|------------|---------------------|-------------------------------|----------|--|--|--|----------------------------|-------------------------------|----------|--|--|--|
| <p>namespace</p> | <p>urn:bridgeall-com:cmaservice:data:v3</p> | | | | | | | | | | | | | | | | | | |
| <p>type</p> | <p>T016.0_UnmeasureableDeclarationType</p> | | | | | | | | | | | | | | | | | | |
| <p>properties</p> | <p>isRef 0 content complex</p> | | | | | | | | | | | | | | | | | | |
| <p>children</p> | <p>D2001_SPID D2024_Unmeasurable D4006_EffectiveFrom</p> | | | | | | | | | | | | | | | | | | |
| <p>attributes</p> | <table border="1"> <thead> <tr> <th>Name</th> <th>Type</th> <th>Use</th> <th>Default</th> <th>Fixed</th> <th>annotation</th> </tr> </thead> <tbody> <tr> <td>MID</td> <td>MessageIdType</td> <td>required</td> <td></td> <td></td> <td></td> </tr> <tr> <td>RelatedMID</td> <td>MessageIdType</td> <td>optional</td> <td></td> <td></td> <td></td> </tr> </tbody> </table> | Name | Type | Use | Default | Fixed | annotation | MID | MessageIdType | required | | | | RelatedMID | MessageIdType | optional | | | |
| Name | Type | Use | Default | Fixed | annotation | | | | | | | | | | | | | | |
| MID | MessageIdType | required | | | | | | | | | | | | | | | | | |
| RelatedMID | MessageIdType | optional | | | | | | | | | | | | | | | | | |
| <p>source</p> | <pre><xs:element name="T016.1_UnmeasureableNotification" type="T016.0_UnmeasureableDeclarationType"/></pre> | | | | | | | | | | | | | | | | | | |

element **ResponseMessagesType/T017.1_MeterSwapNotification**

| diagram | | | | | | | | | | | | | | | | | | | |
|----------------------------|--------------------------------------------------------------------------------------------------------------------------------------------------------------------------------------------------------------------------------------------------------------------------------------------------------------------------------------------------------------------------------------------------------------------------------------------|----------|---------|-------|------------|-------|------------|---------------------|-------------------------------|----------|--|--|--|----------------------------|-------------------------------|----------|--|--|--|
| namespace | urn:bridgeall-com:cmaservice:data:v3 | | | | | | | | | | | | | | | | | | |
| type | MeterSwapNotificationType | | | | | | | | | | | | | | | | | | |
| properties | isRef 0 content complex | | | | | | | | | | | | | | | | | | |
| children | D2001_SPID NewMeter OldMeter D3012_ReRead | | | | | | | | | | | | | | | | | | |
| attributes | <table border="1"> <thead> <tr> <th>Name</th> <th>Type</th> <th>Use</th> <th>Default</th> <th>Fixed</th> <th>annotation</th> </tr> </thead> <tbody> <tr> <td>MID</td> <td>MessageIdType</td> <td>required</td> <td></td> <td></td> <td></td> </tr> <tr> <td>RelatedMID</td> <td>MessageIdType</td> <td>optional</td> <td></td> <td></td> <td></td> </tr> </tbody> </table> | Name | Type | Use | Default | Fixed | annotation | MID | MessageIdType | required | | | | RelatedMID | MessageIdType | optional | | | |
| Name | Type | Use | Default | Fixed | annotation | | | | | | | | | | | | | | |
| MID | MessageIdType | required | | | | | | | | | | | | | | | | | |
| RelatedMID | MessageIdType | optional | | | | | | | | | | | | | | | | | |
| source | <pre><xs:element name="T017.1_MeterSwapNotification" type="MeterSwapNotificationType"/></pre> | | | | | | | | | | | | | | | | | | |

element **ResponseMessagesType/T019.0_WaterSPIDData**

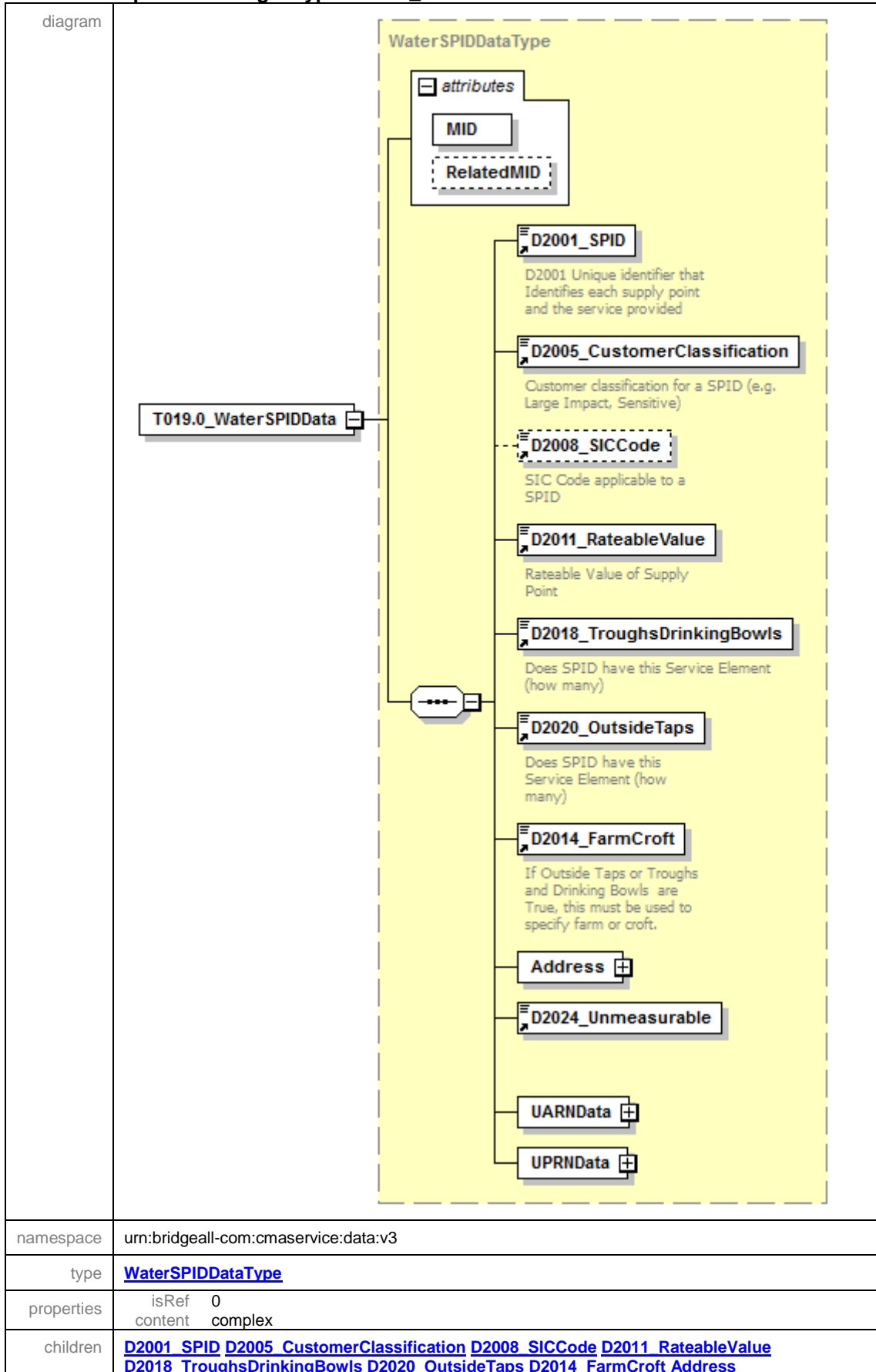

| | | | | | | |
|------------|---------------------------------------------------------------------------------------|-------------------------------|----------|---------|-------|------------|
| | D2024 Unmeasurable UARNDData UPRNDData | | | | | |
| attributes | Name | Type | Use | Default | Fixed | annotation |
| | MID | MessageIdType | required | | | |
| | RelatedMID | MessageIdType | optional | | | |
| source | <code><xs:element name="T019.0_WaterSPIDData" type="WaterSPIDDataType"/></code> | | | | | |

element **ResponseMessagesType/T020.0_SewerageSPIDData**

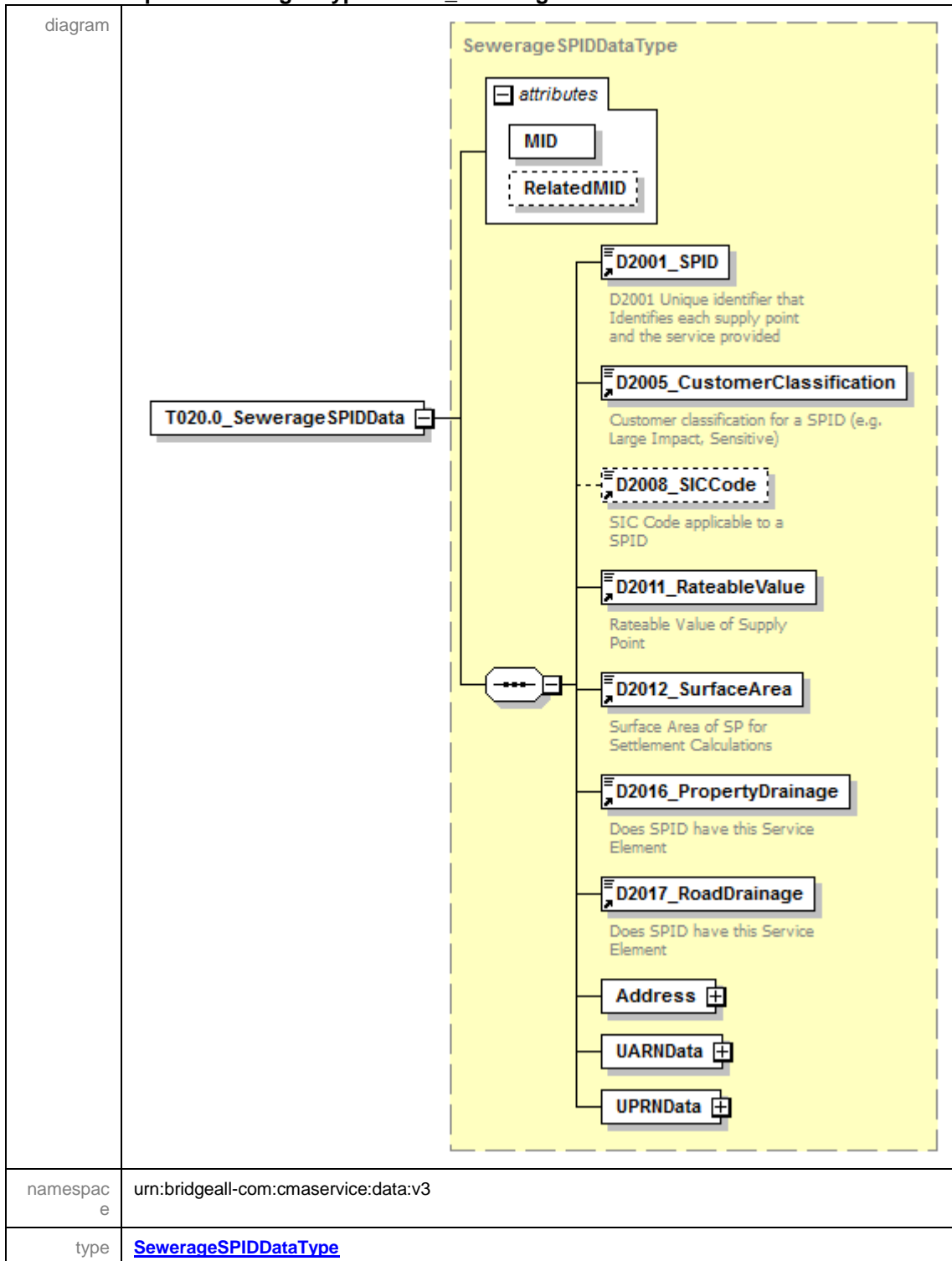

| properties | isRef 0 content complex | | | | | | | | | | | | | | | | | | |
|----------------------------|--------------------------------------------------------------------------------------------------------------------------------------------------------------------------------------------------------------------------------------------------------------------------------------------------------------------------------------------------------------------------------------------------------------------------------------------|----------|---------|-------|------------|-------|------------|---------------------|-------------------------------|----------|--|--|--|----------------------------|-------------------------------|----------|--|--|--|
| children | D2001_SPID D2005_CustomerClassification D2008_SICCode D2011_RateableValue D2012_SurfaceArea D2016_PropertyDrainage D2017_RoadDrainage Address UARNDData UPRNData | | | | | | | | | | | | | | | | | | |
| attributes | <table border="1"> <thead> <tr> <th>Name</th> <th>Type</th> <th>Use</th> <th>Default</th> <th>Fixed</th> <th>annotation</th> </tr> </thead> <tbody> <tr> <td>MID</td> <td>MessageIdType</td> <td>required</td> <td></td> <td></td> <td></td> </tr> <tr> <td>RelatedMID</td> <td>MessageIdType</td> <td>optional</td> <td></td> <td></td> <td></td> </tr> </tbody> </table> | Name | Type | Use | Default | Fixed | annotation | MID | MessageIdType | required | | | | RelatedMID | MessageIdType | optional | | | |
| Name | Type | Use | Default | Fixed | annotation | | | | | | | | | | | | | | |
| MID | MessageIdType | required | | | | | | | | | | | | | | | | | |
| RelatedMID | MessageIdType | optional | | | | | | | | | | | | | | | | | |
| source | <code><xs:element name="T020.0_SewerageSPIDData" type="SewerageSPIDDataType"/></code> | | | | | | | | | | | | | | | | | | |

element **ResponseMessagesType/T021.1_DPIDNotification**

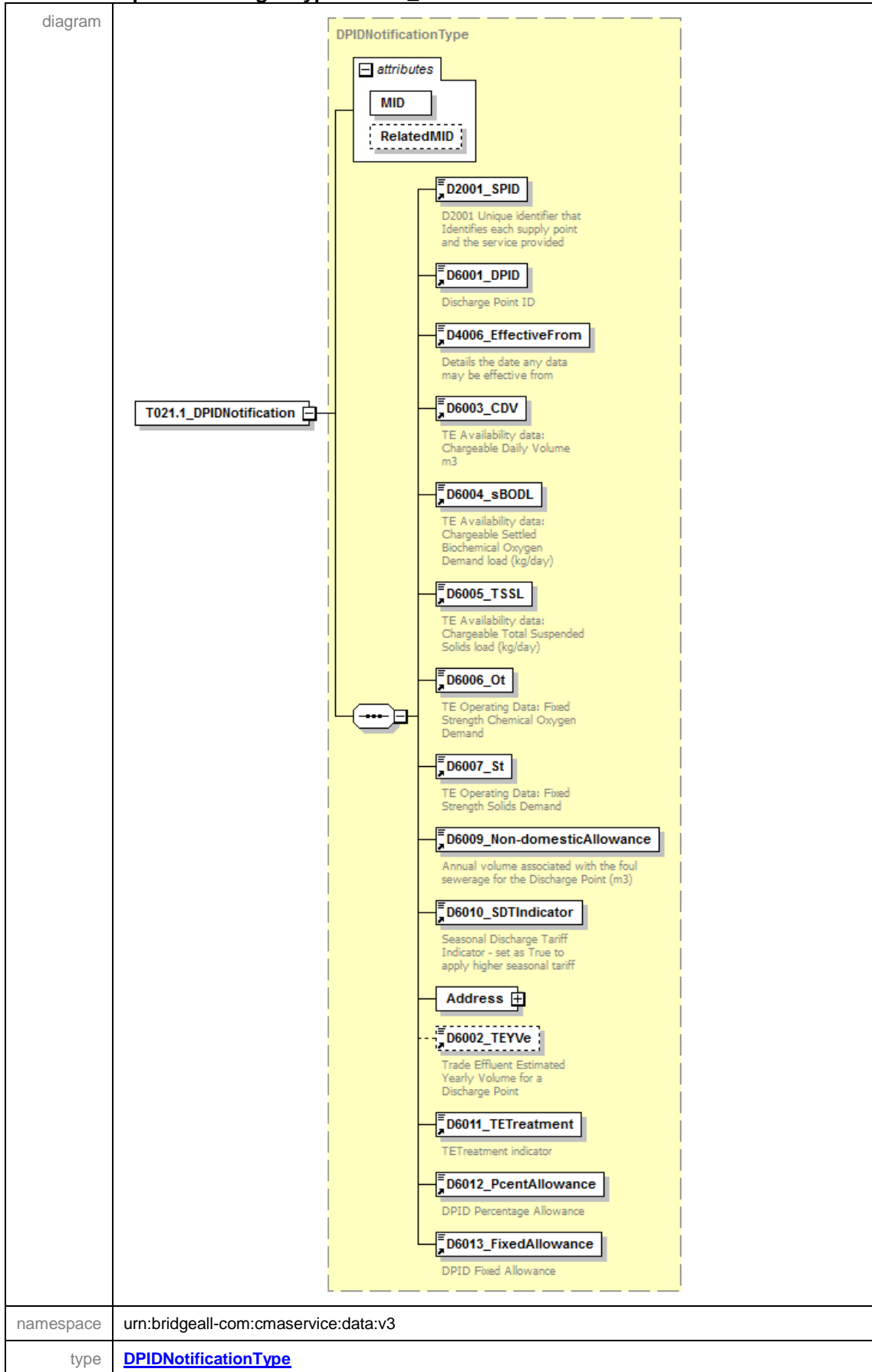

| properties | isRef 0 content complex | | | | | | | | | | | | | | | | | | |
|----------------------------|-----------------------------------------------------------------------------------------------------------------------------------------------------------------------------------------------------------------------------------------------------------------------------------------------------------------------------------------------------------------------------------------------------------------------------------------------------------------------------|----------|---------|-------|------------|-------|------------|---------------------|-------------------------------|----------|--|--|--|----------------------------|-------------------------------|----------|--|--|--|
| children | D2001_SPID D6001_DPID D4006_EffectiveFrom D6003_CDV D6004_sBODL D6005_TSSL D6006_Ot D6007_St D6009_Non-domesticAllowance D6010_SDTIndicator Address D6002_TeYVe D6011_TETreatment D6012_PcentAllowance D6013_FixedAllowance | | | | | | | | | | | | | | | | | | |
| attributes | <table border="1"> <thead> <tr> <th>Name</th> <th>Type</th> <th>Use</th> <th>Default</th> <th>Fixed</th> <th>annotation</th> </tr> </thead> <tbody> <tr> <td>MID</td> <td>MessageIdType</td> <td>required</td> <td></td> <td></td> <td></td> </tr> <tr> <td>RelatedMID</td> <td>MessageIdType</td> <td>optional</td> <td></td> <td></td> <td></td> </tr> </tbody> </table> | Name | Type | Use | Default | Fixed | annotation | MID | MessageIdType | required | | | | RelatedMID | MessageIdType | optional | | | |
| Name | Type | Use | Default | Fixed | annotation | | | | | | | | | | | | | | |
| MID | MessageIdType | required | | | | | | | | | | | | | | | | | |
| RelatedMID | MessageIdType | optional | | | | | | | | | | | | | | | | | |
| source | <code><xs:element name="T021.1_DPIDNotification" type="DPIDNotificationType"/></code> | | | | | | | | | | | | | | | | | | |

element **ResponseMessagesType/T022.1_TEUpdateNotification**

| diagram | | | | | | | | | | | | | | | | | | | |
|----------------------------|--------------------------------------------------------------------------------------------------------------------------------------------------------------------------------------------------------------------------------------------------------------------------------------------------------------------------------------------------------------------------------------------------------------------------------------------|----------|---------|-------|------------|-------|------------|---------------------|-------------------------------|----------|--|--|--|----------------------------|-------------------------------|----------|--|--|--|
| namespace | urn:bridgeall-com:cmaservice:data:v3 | | | | | | | | | | | | | | | | | | |
| type | TEUpdateType | | | | | | | | | | | | | | | | | | |
| properties | isRef 0 content complex | | | | | | | | | | | | | | | | | | |
| children | D2001_SPID D6001_DPID D4006_EffectiveFrom D6006_Ot D6007_St | | | | | | | | | | | | | | | | | | |
| attributes | <table border="1"> <thead> <tr> <th>Name</th> <th>Type</th> <th>Use</th> <th>Default</th> <th>Fixed</th> <th>annotation</th> </tr> </thead> <tbody> <tr> <td>MID</td> <td>MessageIdType</td> <td>required</td> <td></td> <td></td> <td></td> </tr> <tr> <td>RelatedMID</td> <td>MessageIdType</td> <td>optional</td> <td></td> <td></td> <td></td> </tr> </tbody> </table> | Name | Type | Use | Default | Fixed | annotation | MID | MessageIdType | required | | | | RelatedMID | MessageIdType | optional | | | |
| Name | Type | Use | Default | Fixed | annotation | | | | | | | | | | | | | | |
| MID | MessageIdType | required | | | | | | | | | | | | | | | | | |
| RelatedMID | MessageIdType | optional | | | | | | | | | | | | | | | | | |
| source | <code><xs:element name="T022.1_TEUpdateNotification" type="TEUpdateType"/></code> | | | | | | | | | | | | | | | | | | |

element **ResponseMessagesType/T023.1_MeterAssociationNotification**

| diagram | <p>The diagram illustrates the structure of the T023.1_MeterAssociationNotification element. It is a complex type containing an attributes group and five data elements:</p> <ul style="list-style-type: none"> attributes (group): Contains MID (required) and RelatedMID (optional). D2001_SPID: D2001 Unique identifier that Identifies each supply point and the service provided. D6001_DPID: Discharge Point ID. D3001_MeterId: Meter Identification (e.g. manufacturers serial number). D4006_EffectiveFrom: Details the date any data may be effective from. D3024_MDVol: The Meter-DPID Volume for a particular DP-MeterAssociation. | | | | | | | | | | | | | | | | | | |
|----------------------------|---------------------------------------------------------------------------------------------------------------------------------------------------------------------------------------------------------------------------------------------------------------------------------------------------------------------------------------------------------------------------------------------------------------------------------------------------------------------------------------------------------------------------------------------------------------------------------------------------------------------------------------------------------------------------------------------------------------------------------------------------------------------------------|----------|---------|-------|------------|-------|------------|---------------------|-------------------------------|----------|--|--|--|----------------------------|-------------------------------|----------|--|--|--|
| namespace | urn:bridgeall-com:cmaservice:data:v3 | | | | | | | | | | | | | | | | | | |
| type | MeterAssociationType | | | | | | | | | | | | | | | | | | |
| properties | isRef 0 content complex | | | | | | | | | | | | | | | | | | |
| children | D2001_SPID D6001_DPID D3001_MeterId D4006_EffectiveFrom D3024_MDVol | | | | | | | | | | | | | | | | | | |
| attributes | <table border="1"> <thead> <tr> <th>Name</th> <th>Type</th> <th>Use</th> <th>Default</th> <th>Fixed</th> <th>annotation</th> </tr> </thead> <tbody> <tr> <td>MID</td> <td>MessageIdType</td> <td>required</td> <td></td> <td></td> <td></td> </tr> <tr> <td>RelatedMID</td> <td>MessageIdType</td> <td>optional</td> <td></td> <td></td> <td></td> </tr> </tbody> </table> | Name | Type | Use | Default | Fixed | annotation | MID | MessageIdType | required | | | | RelatedMID | MessageIdType | optional | | | |
| Name | Type | Use | Default | Fixed | annotation | | | | | | | | | | | | | | |
| MID | MessageIdType | required | | | | | | | | | | | | | | | | | |
| RelatedMID | MessageIdType | optional | | | | | | | | | | | | | | | | | |
| source | <pre><xs:element name="T023.1_MeterAssociationNotification" type="MeterAssociationType"/></pre> | | | | | | | | | | | | | | | | | | |

element **ResponseMessagesType/T024.1_MeterDisAssociationNotification**

| <p>diagram</p> | | | | | | | | | | | | | | | | | | | |
|----------------------------|--------------------------------------------------------------------------------------------------------------------------------------------------------------------------------------------------------------------------------------------------------------------------------------------------------------------------------------------------------------------------------------------------------------------------------------------|----------|---------|-------|------------|-------|------------|---------------------|-------------------------------|----------|--|--|--|----------------------------|-------------------------------|----------|--|--|--|
| <p>namespace</p> | <p>urn:bridgeall-com:cmaservice:data:v3</p> | | | | | | | | | | | | | | | | | | |
| <p>type</p> | <p>MeterDisAssociationType</p> | | | | | | | | | | | | | | | | | | |
| <p>properties</p> | <p>isRef 0 content complex</p> | | | | | | | | | | | | | | | | | | |
| <p>children</p> | <p>D2001_SPID D6001_DPID D3001_MeterId D4006_EffectiveFrom</p> | | | | | | | | | | | | | | | | | | |
| <p>attributes</p> | <table border="1"> <thead> <tr> <th>Name</th> <th>Type</th> <th>Use</th> <th>Default</th> <th>Fixed</th> <th>annotation</th> </tr> </thead> <tbody> <tr> <td>MID</td> <td>MessageIdType</td> <td>required</td> <td></td> <td></td> <td></td> </tr> <tr> <td>RelatedMID</td> <td>MessageIdType</td> <td>optional</td> <td></td> <td></td> <td></td> </tr> </tbody> </table> | Name | Type | Use | Default | Fixed | annotation | MID | MessageIdType | required | | | | RelatedMID | MessageIdType | optional | | | |
| Name | Type | Use | Default | Fixed | annotation | | | | | | | | | | | | | | |
| MID | MessageIdType | required | | | | | | | | | | | | | | | | | |
| RelatedMID | MessageIdType | optional | | | | | | | | | | | | | | | | | |
| <p>source</p> | <pre><xs:element name="T024.1_MeterDisAssociationNotification" type="MeterDisAssociationType"/></pre> | | | | | | | | | | | | | | | | | | |

element **ResponseMessagesType/T026.1_DiscontinueDPIDNotification**

| <p>diagram</p> | | | | | | | | | | | | | | | | | | | |
|----------------------------|--------------------------------------------------------------------------------------------------------------------------------------------------------------------------------------------------------------------------------------------------------------------------------------------------------------------------------------------------------------------------------------------------------------------------------------------|----------|---------|-------|------------|-------|------------|---------------------|-------------------------------|----------|--|--|--|----------------------------|-------------------------------|----------|--|--|--|
| <p>namespace</p> | <p>urn:bridgeall-com:cmaservice:data:v3</p> | | | | | | | | | | | | | | | | | | |
| <p>type</p> | <p>DiscontinueDPIDType</p> | | | | | | | | | | | | | | | | | | |
| <p>properties</p> | <p>isRef 0 content complex</p> | | | | | | | | | | | | | | | | | | |
| <p>children</p> | <p>D2001_SPID D6001_DPID D4006_EffectiveFrom</p> | | | | | | | | | | | | | | | | | | |
| <p>attributes</p> | <table border="1"> <thead> <tr> <th>Name</th> <th>Type</th> <th>Use</th> <th>Default</th> <th>Fixed</th> <th>annotation</th> </tr> </thead> <tbody> <tr> <td>MID</td> <td>MessageIdType</td> <td>required</td> <td></td> <td></td> <td></td> </tr> <tr> <td>RelatedMID</td> <td>MessageIdType</td> <td>optional</td> <td></td> <td></td> <td></td> </tr> </tbody> </table> | Name | Type | Use | Default | Fixed | annotation | MID | MessageIdType | required | | | | RelatedMID | MessageIdType | optional | | | |
| Name | Type | Use | Default | Fixed | annotation | | | | | | | | | | | | | | |
| MID | MessageIdType | required | | | | | | | | | | | | | | | | | |
| RelatedMID | MessageIdType | optional | | | | | | | | | | | | | | | | | |
| <p>source</p> | <pre><xs:element name="T026.1_DiscontinueDPIDNotification" type="DiscontinueDPIDType"/></pre> | | | | | | | | | | | | | | | | | | |

element **ResponseMessagesType/T027.1_DPIDUpdateNotification**

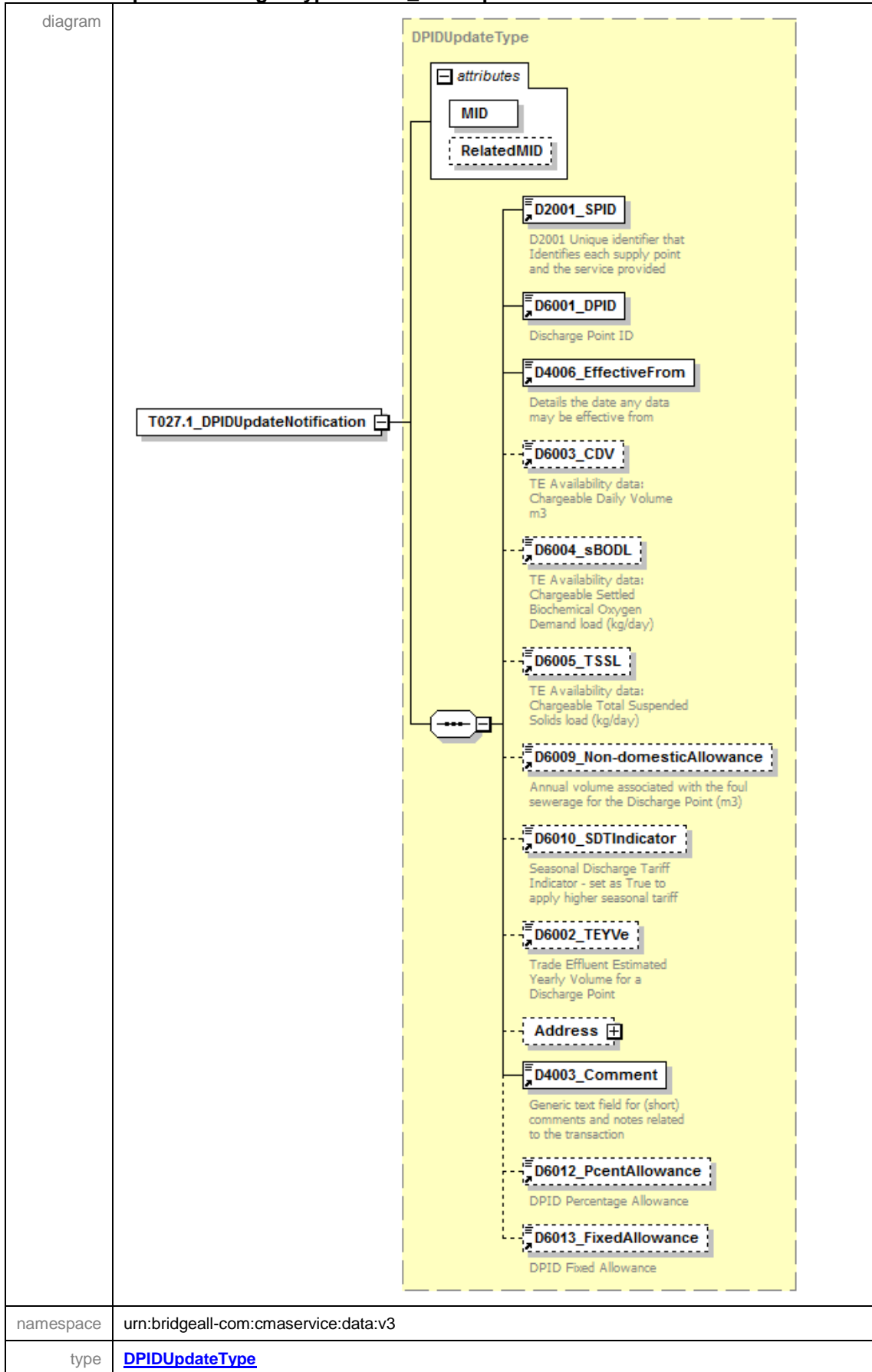

| properties | isRef 0 content complex | | | | | | | | | | | | | | | | | | |
|----------------------------|--------------------------------------------------------------------------------------------------------------------------------------------------------------------------------------------------------------------------------------------------------------------------------------------------------------------------------------------------------------------------------------------------------------------------------------------|----------|---------|-------|------------|-------|------------|---------------------|-------------------------------|----------|--|--|--|----------------------------|-------------------------------|----------|--|--|--|
| children | D2001_SPID D6001_DPID D4006_EffectiveFrom D6003_CDV D6004_sBODL D6005_TSSL D6009_Non-domesticAllowance D6010_SDIndicator D6002_TeyVe Address D4003_Comment D6012_PcentAllowance D6013_FixedAllowance | | | | | | | | | | | | | | | | | | |
| attributes | <table border="1"> <thead> <tr> <th>Name</th> <th>Type</th> <th>Use</th> <th>Default</th> <th>Fixed</th> <th>annotation</th> </tr> </thead> <tbody> <tr> <td>MID</td> <td>MessageIdType</td> <td>required</td> <td></td> <td></td> <td></td> </tr> <tr> <td>RelatedMID</td> <td>MessageIdType</td> <td>optional</td> <td></td> <td></td> <td></td> </tr> </tbody> </table> | Name | Type | Use | Default | Fixed | annotation | MID | MessageIdType | required | | | | RelatedMID | MessageIdType | optional | | | |
| Name | Type | Use | Default | Fixed | annotation | | | | | | | | | | | | | | |
| MID | MessageIdType | required | | | | | | | | | | | | | | | | | |
| RelatedMID | MessageIdType | optional | | | | | | | | | | | | | | | | | |
| source | <code><xs:element name="T027.1_DPIDUpdateNotification" type="DPIDUpdateType"/></code> | | | | | | | | | | | | | | | | | | |

element **ResponseMessagesType/T028.0_Schedule3UpdateNotification**

| diagram | | | | | | | | | | | | | | | | | | | |
|----------------------------|--------------------------------------------------------------------------------------------------------------------------------------------------------------------------------------------------------------------------------------------------------------------------------------------------------------------------------------------------------------------------------------------------------------------------------------------|----------|---------|-------|------------|-------|------------|---------------------|-------------------------------|----------|--|--|--|----------------------------|-------------------------------|----------|--|--|--|
| namespace | urn:bridgeall-com:cmaservice:data:v3 | | | | | | | | | | | | | | | | | | |
| type | Schedule3UpdateType | | | | | | | | | | | | | | | | | | |
| properties | isRef 0 content complex | | | | | | | | | | | | | | | | | | |
| children | D2001_SPID D2003_Schedule3 D4006_EffectiveFrom D6001_DPID | | | | | | | | | | | | | | | | | | |
| attributes | <table border="1"> <thead> <tr> <th>Name</th> <th>Type</th> <th>Use</th> <th>Default</th> <th>Fixed</th> <th>annotation</th> </tr> </thead> <tbody> <tr> <td>MID</td> <td>MessageIdType</td> <td>required</td> <td></td> <td></td> <td></td> </tr> <tr> <td>RelatedMID</td> <td>MessageIdType</td> <td>optional</td> <td></td> <td></td> <td></td> </tr> </tbody> </table> | Name | Type | Use | Default | Fixed | annotation | MID | MessageIdType | required | | | | RelatedMID | MessageIdType | optional | | | |
| Name | Type | Use | Default | Fixed | annotation | | | | | | | | | | | | | | |
| MID | MessageIdType | required | | | | | | | | | | | | | | | | | |
| RelatedMID | MessageIdType | optional | | | | | | | | | | | | | | | | | |
| source | <code><xs:element name="T028.0_Schedule3UpdateNotification" type="Schedule3UpdateType"/></code> | | | | | | | | | | | | | | | | | | |

element **ResponseMessagesType/T029.0_SpecialArrangementsUpdateNotification**

| <p>diagram</p> | <p>SpecialArrangementsUpdateNotificationType</p> <ul style="list-style-type: none"> attributes <ul style="list-style-type: none"> MID (required) RelatedMID (optional) D2001_SPID (required): D2001 Unique identifier that Identifies each supply point and the service provided D4006_EffectiveFrom (required): Details the date any data may be effective from D2003_Schedule3 (optional): Schedule 3 percentage discount applied to service element D2004_ExemptCustomerFlag (optional): Scottish Executive Exempt Scheme flag D2041_PcentExemption (optional): The percentage of the D2004_ExemptCustomerFlag that is applied D2006_29e (optional): 29e percentage discount applied per SPID D2007_LargeVolAgreement (optional): Large-User Volume Agreement (LUV A) for SPID | | | | | | | | | | | | | | | | | | |
|----------------------------|-----------------------------------------------------------------------------------------------------------------------------------------------------------------------------------------------------------------------------------------------------------------------------------------------------------------------------------------------------------------------------------------------------------------------------------------------------------------------------------------------------------------------------------------------------------------------------------------------------------------------------------------------------------------------------------------------------------------------------------------------------------------------------------------------------------------------------------------------------------------------------------------------------------------------------------------------------------------------|----------|---------|-------|------------|-------|------------|---------------------|-------------------------------|----------|--|--|--|----------------------------|-------------------------------|----------|--|--|--|
| <p>namespace</p> | <p>urn:bridgeall-com:cmaservice:data:v3</p> | | | | | | | | | | | | | | | | | | |
| <p>type</p> | <p>SpecialArrangementsUpdateNotificationType</p> | | | | | | | | | | | | | | | | | | |
| <p>properties</p> | <p>isRef 0 content complex</p> | | | | | | | | | | | | | | | | | | |
| <p>children</p> | <p>D2001_SPID D4006_EffectiveFrom D2003_Schedule3 D2004_ExemptCustomerFlag D2041_PcentExemption D2006_29e D2007_LargeVolAgreement</p> | | | | | | | | | | | | | | | | | | |
| <p>attributes</p> | <table border="1"> <thead> <tr> <th>Name</th> <th>Type</th> <th>Use</th> <th>Default</th> <th>Fixed</th> <th>annotation</th> </tr> </thead> <tbody> <tr> <td>MID</td> <td>MessageIdType</td> <td>required</td> <td></td> <td></td> <td></td> </tr> <tr> <td>RelatedMID</td> <td>MessageIdType</td> <td>optional</td> <td></td> <td></td> <td></td> </tr> </tbody> </table> | Name | Type | Use | Default | Fixed | annotation | MID | MessageIdType | required | | | | RelatedMID | MessageIdType | optional | | | |
| Name | Type | Use | Default | Fixed | annotation | | | | | | | | | | | | | | |
| MID | MessageIdType | required | | | | | | | | | | | | | | | | | |
| RelatedMID | MessageIdType | optional | | | | | | | | | | | | | | | | | |
| <p>source</p> | <pre><xs:element name="T029.0_SpecialArrangementsUpdateNotification" type="SpecialArrangementsUpdateNotificationType"/></pre> | | | | | | | | | | | | | | | | | | |

element

ResponseMessageType/T029.4_PremisesSpecialArrangementsUpdateNotification

| <p>diagram</p> | | | | | | | | | | | | | | | | | | | |
|----------------------------|--------------------------------------------------------------------------------------------------------------------------------------------------------------------------------------------------------------------------------------------------------------------------------------------------------------------------------------------------------------------------------------------------------------------------------------------|----------|---------|-------|------------|-------|------------|---------------------|-------------------------------|----------|--|--|--|----------------------------|-------------------------------|----------|--|--|--|
| <p>namespace</p> | <p>urn:bridgeall-com:cmaservice:data:v3</p> | | | | | | | | | | | | | | | | | | |
| <p>type</p> | <p>PremisesSpecialArrangementsUpdateNotificationType</p> | | | | | | | | | | | | | | | | | | |
| <p>properties</p> | <p>isRef 0 content complex</p> | | | | | | | | | | | | | | | | | | |
| <p>children</p> | <p>D2001_SPID D4006_EffectiveFrom D2004_ExemptCustomerFlag D2041_PcentExemption</p> | | | | | | | | | | | | | | | | | | |
| <p>attributes</p> | <table border="1"> <thead> <tr> <th>Name</th> <th>Type</th> <th>Use</th> <th>Default</th> <th>Fixed</th> <th>annotation</th> </tr> </thead> <tbody> <tr> <td>MID</td> <td>MessageIdType</td> <td>required</td> <td></td> <td></td> <td></td> </tr> <tr> <td>RelatedMID</td> <td>MessageIdType</td> <td>optional</td> <td></td> <td></td> <td></td> </tr> </tbody> </table> | Name | Type | Use | Default | Fixed | annotation | MID | MessageIdType | required | | | | RelatedMID | MessageIdType | optional | | | |
| Name | Type | Use | Default | Fixed | annotation | | | | | | | | | | | | | | |
| MID | MessageIdType | required | | | | | | | | | | | | | | | | | |
| RelatedMID | MessageIdType | optional | | | | | | | | | | | | | | | | | |
| <p>source</p> | <pre><xs:element name="T029.4_PremisesSpecialArrangementsUpdateNotification" type="PremisesSpecialArrangementsUpdateNotificationType"/></pre> | | | | | | | | | | | | | | | | | | |

element **ResponseMessagesType/T030.0_DPMeterReadNotification**

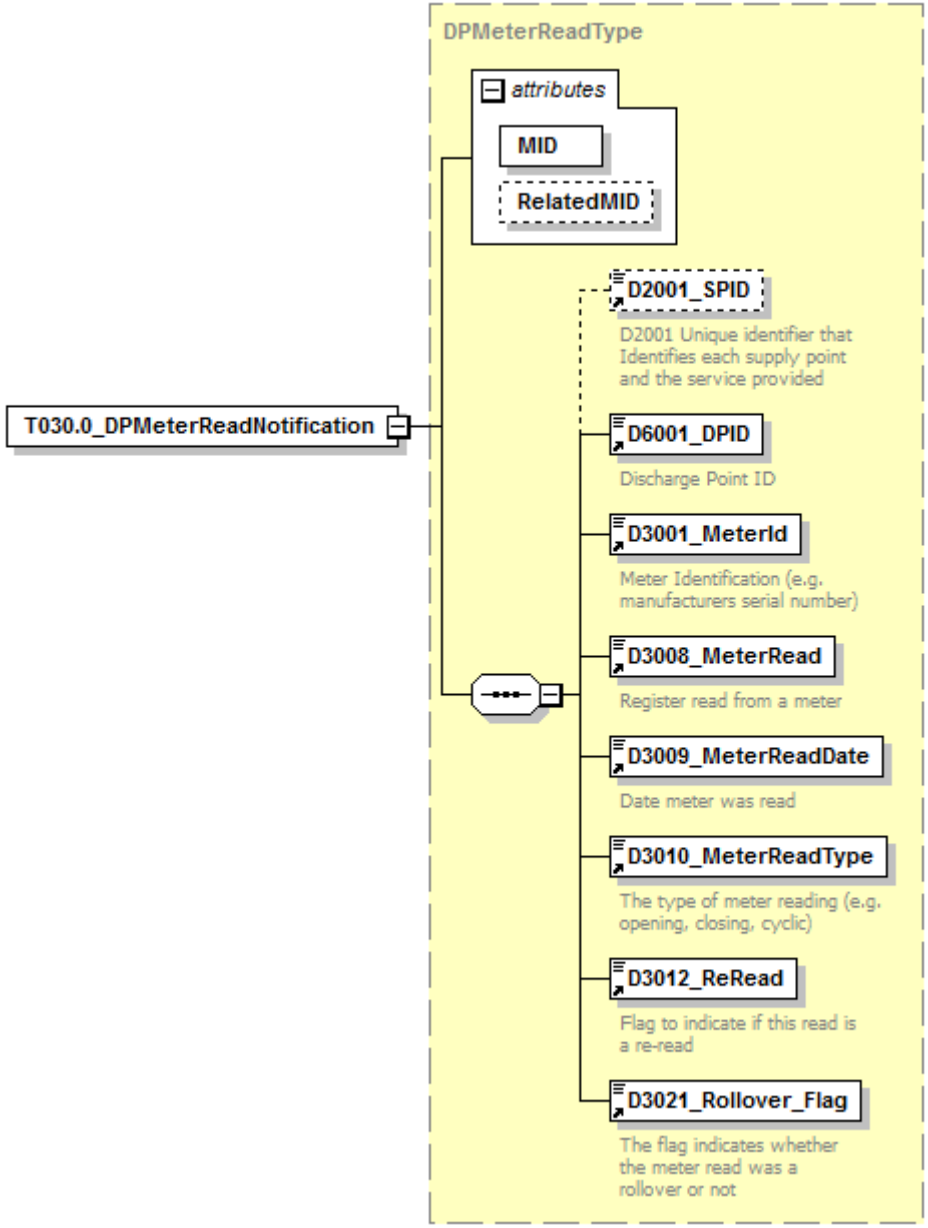
| <p>diagram</p> |  | | | | | | | | | | | | | | | | | | |
|----------------------------|--------------------------------------------------------------------------------------------------------------------------------------------------------------------------------------------------------------------------------------------------------------------------------------------------------------------------------------------------------------------------------------------------------------------------------------------|----------|---------|-------|------------|-------|------------|---------------------|-------------------------------|----------|--|--|--|----------------------------|-------------------------------|----------|--|--|--|
| <p>namespace</p> | <p>urn:bridgeall-com:cmaservice:data:v3</p> | | | | | | | | | | | | | | | | | | |
| <p>type</p> | <p>DPMeterReadType</p> | | | | | | | | | | | | | | | | | | |
| <p>properties</p> | <p>isRef 0 content complex</p> | | | | | | | | | | | | | | | | | | |
| <p>children</p> | <p>D2001_SPID D6001_DPID D3001_MeterId D3008_MeterRead D3009_MeterReadDate D3010_MeterReadType D3012_ReRead D3021_Rollover_Flag</p> | | | | | | | | | | | | | | | | | | |
| <p>attributes</p> | <table border="1"> <thead> <tr> <th>Name</th> <th>Type</th> <th>Use</th> <th>Default</th> <th>Fixed</th> <th>annotation</th> </tr> </thead> <tbody> <tr> <td>MID</td> <td>MessageIdType</td> <td>required</td> <td></td> <td></td> <td></td> </tr> <tr> <td>RelatedMID</td> <td>MessageIdType</td> <td>optional</td> <td></td> <td></td> <td></td> </tr> </tbody> </table> | Name | Type | Use | Default | Fixed | annotation | MID | MessageIdType | required | | | | RelatedMID | MessageIdType | optional | | | |
| Name | Type | Use | Default | Fixed | annotation | | | | | | | | | | | | | | |
| MID | MessageIdType | required | | | | | | | | | | | | | | | | | |
| RelatedMID | MessageIdType | optional | | | | | | | | | | | | | | | | | |
| <p>source</p> | <pre><xs:element name="T030.0_DPMeterReadNotification" type="DPMeterReadType"/></pre> | | | | | | | | | | | | | | | | | | |

element **ResponseMessagesType/T030.1_DPMeterReadNotification**

| <p>diagram</p> | | | | | | | | | | | | | | | | | | | |
|----------------------------|--------------------------------------------------------------------------------------------------------------------------------------------------------------------------------------------------------------------------------------------------------------------------------------------------------------------------------------------------------------------------------------------------------------------------------------------|----------|---------|-------|------------|-------|------------|---------------------|-------------------------------|----------|--|--|--|----------------------------|-------------------------------|----------|--|--|--|
| <p>namespace</p> | <p>urn:bridgeall-com:cmaservice:data:v3</p> | | | | | | | | | | | | | | | | | | |
| <p>type</p> | <p>DPMeterReadType</p> | | | | | | | | | | | | | | | | | | |
| <p>properties</p> | <p>isRef 0 content complex</p> | | | | | | | | | | | | | | | | | | |
| <p>children</p> | <p>D2001_SPID D6001_DPID D3001_MeterId D3008_MeterRead D3009_MeterReadDate D3010_MeterReadType D3012_ReRead D3021_Rollover_Flag</p> | | | | | | | | | | | | | | | | | | |
| <p>attributes</p> | <table border="1"> <thead> <tr> <th>Name</th> <th>Type</th> <th>Use</th> <th>Default</th> <th>Fixed</th> <th>annotation</th> </tr> </thead> <tbody> <tr> <td>MID</td> <td>MessageIdType</td> <td>required</td> <td></td> <td></td> <td></td> </tr> <tr> <td>RelatedMID</td> <td>MessageIdType</td> <td>optional</td> <td></td> <td></td> <td></td> </tr> </tbody> </table> | Name | Type | Use | Default | Fixed | annotation | MID | MessageIdType | required | | | | RelatedMID | MessageIdType | optional | | | |
| Name | Type | Use | Default | Fixed | annotation | | | | | | | | | | | | | | |
| MID | MessageIdType | required | | | | | | | | | | | | | | | | | |
| RelatedMID | MessageIdType | optional | | | | | | | | | | | | | | | | | |
| <p>source</p> | <pre><xs:element name="T030.1_DPMeterReadNotification" type="DPMeterReadType"/></pre> | | | | | | | | | | | | | | | | | | |

element **ResponseMessagesType/T032.1_CustomerNameUpdated**

| <p>diagram</p> | | | | | | | | | | | | | | | | | | | |
|----------------------------|--------------------------------------------------------------------------------------------------------------------------------------------------------------------------------------------------------------------------------------------------------------------------------------------------------------------------------------------------------------------------------------------------------------------------------------------|----------|---------|-------|------------|-------|------------|---------------------|-------------------------------|----------|--|--|--|----------------------------|-------------------------------|----------|--|--|--|
| <p>namespace</p> | <p>urn:bridgeall-com:cmaservice:data:v3</p> | | | | | | | | | | | | | | | | | | |
| <p>type</p> | <p>T032.1_CustomerNameUpdatedType</p> | | | | | | | | | | | | | | | | | | |
| <p>properties</p> | <p>isRef 0 content complex</p> | | | | | | | | | | | | | | | | | | |
| <p>children</p> | <p>D2001_SPID D2027_CustomerName D2028_CustomerNameType</p> | | | | | | | | | | | | | | | | | | |
| <p>attributes</p> | <table border="1"> <thead> <tr> <th>Name</th> <th>Type</th> <th>Use</th> <th>Default</th> <th>Fixed</th> <th>annotation</th> </tr> </thead> <tbody> <tr> <td>MID</td> <td>MessageIdType</td> <td>required</td> <td></td> <td></td> <td></td> </tr> <tr> <td>RelatedMID</td> <td>MessageIdType</td> <td>optional</td> <td></td> <td></td> <td></td> </tr> </tbody> </table> | Name | Type | Use | Default | Fixed | annotation | MID | MessageIdType | required | | | | RelatedMID | MessageIdType | optional | | | |
| Name | Type | Use | Default | Fixed | annotation | | | | | | | | | | | | | | |
| MID | MessageIdType | required | | | | | | | | | | | | | | | | | |
| RelatedMID | MessageIdType | optional | | | | | | | | | | | | | | | | | |
| <p>source</p> | <pre><xs:element name="T032.1_CustomerNameUpdated" type="T032.1_CustomerNameUpdatedType"/></pre> | | | | | | | | | | | | | | | | | | |

element **ResponseMessagesType/T032.2_CustomerNameUpdatedNotification**

| <p>diagram</p> | | | | | | | | | | | | | | | | | | | |
|----------------------------|--------------------------------------------------------------------------------------------------------------------------------------------------------------------------------------------------------------------------------------------------------------------------------------------------------------------------------------------------------------------------------------------------------------------------------------------|----------|---------|-------|------------|-------|------------|---------------------|-------------------------------|----------|--|--|--|----------------------------|-------------------------------|----------|--|--|--|
| <p>namespace</p> | <p>urn:bridgeall-com:cmaservice:data:v3</p> | | | | | | | | | | | | | | | | | | |
| <p>type</p> | <p>CustomerNameUpdatedNotificationType</p> | | | | | | | | | | | | | | | | | | |
| <p>properties</p> | <p>isRef 0 content complex</p> | | | | | | | | | | | | | | | | | | |
| <p>children</p> | <p>D2001 SPID D2027 CustomerName D2028 CustomerNameType D4001 OrgId</p> | | | | | | | | | | | | | | | | | | |
| <p>attributes</p> | <table border="1"> <thead> <tr> <th>Name</th> <th>Type</th> <th>Use</th> <th>Default</th> <th>Fixed</th> <th>annotation</th> </tr> </thead> <tbody> <tr> <td>MID</td> <td>MessageIdType</td> <td>required</td> <td></td> <td></td> <td></td> </tr> <tr> <td>RelatedMID</td> <td>MessageIdType</td> <td>optional</td> <td></td> <td></td> <td></td> </tr> </tbody> </table> | Name | Type | Use | Default | Fixed | annotation | MID | MessageIdType | required | | | | RelatedMID | MessageIdType | optional | | | |
| Name | Type | Use | Default | Fixed | annotation | | | | | | | | | | | | | | |
| MID | MessageIdType | required | | | | | | | | | | | | | | | | | |
| RelatedMID | MessageIdType | optional | | | | | | | | | | | | | | | | | |
| <p>source</p> | <pre><xs:element name="T032.2_CustomerNameUpdatedNotification" type="CustomerNameUpdatedNotificationType"/></pre> | | | | | | | | | | | | | | | | | | |

element **ResponseMessageType/T033.1_MeteredBuildingUpdate**

| <p>diagram</p> | <p>The diagram shows the structure of the T033.1_MeteredBuildingUpdate element. It is a complex type containing an attributes block and three child elements:</p> <ul style="list-style-type: none"> attributes: Contains MID (required) and RelatedMID (optional). D2001_SPID: D2001 Unique identifier that Identifies each supply point and the service provided. D2029_MeteredBuildingWater: D2029 Flag to indicate if the site is a metered building construction site. D2030_MeteredBuildingWaterEffectiveDate: D2030 Date when the SPID became a metered building construction site (if D2029 = True) or was no longer a metered building construction site (if D2029 = False). | | | | | | | | | | | | | | | | | | |
|----------------------------|-----------------------------------------------------------------------------------------------------------------------------------------------------------------------------------------------------------------------------------------------------------------------------------------------------------------------------------------------------------------------------------------------------------------------------------------------------------------------------------------------------------------------------------------------------------------------------------------------------------------------------------------------------------------------------------------------------------------------------------------------------------------------------------------|----------|---------|-------|------------|-------|------------|---------------------|-------------------------------|----------|--|--|--|----------------------------|-------------------------------|----------|--|--|--|
| <p>namespace</p> | <p>urn:bridgeall-com:cmaservice:data:v3</p> | | | | | | | | | | | | | | | | | | |
| <p>type</p> | <p>T033.1_MeteredBuildingUpdate</p> | | | | | | | | | | | | | | | | | | |
| <p>properties</p> | <p>isRef 0 content complex</p> | | | | | | | | | | | | | | | | | | |
| <p>children</p> | <p>D2001_SPID D2029_MeteredBuildingWater D2030_MeteredBuildingWaterEffectiveDate</p> | | | | | | | | | | | | | | | | | | |
| <p>attributes</p> | <table border="1"> <thead> <tr> <th>Name</th> <th>Type</th> <th>Use</th> <th>Default</th> <th>Fixed</th> <th>annotation</th> </tr> </thead> <tbody> <tr> <td>MID</td> <td>MessageIdType</td> <td>required</td> <td></td> <td></td> <td></td> </tr> <tr> <td>RelatedMID</td> <td>MessageIdType</td> <td>optional</td> <td></td> <td></td> <td></td> </tr> </tbody> </table> | Name | Type | Use | Default | Fixed | annotation | MID | MessageIdType | required | | | | RelatedMID | MessageIdType | optional | | | |
| Name | Type | Use | Default | Fixed | annotation | | | | | | | | | | | | | | |
| MID | MessageIdType | required | | | | | | | | | | | | | | | | | |
| RelatedMID | MessageIdType | optional | | | | | | | | | | | | | | | | | |
| <p>source</p> | <pre><xs:element name="T033.1_MeteredBuildingUpdate" type="T033.1_MeteredBuildingUpdate"/></pre> | | | | | | | | | | | | | | | | | | |

element **ResponseMessageType/T034.1_VacSchemeGracePeriodNotification**

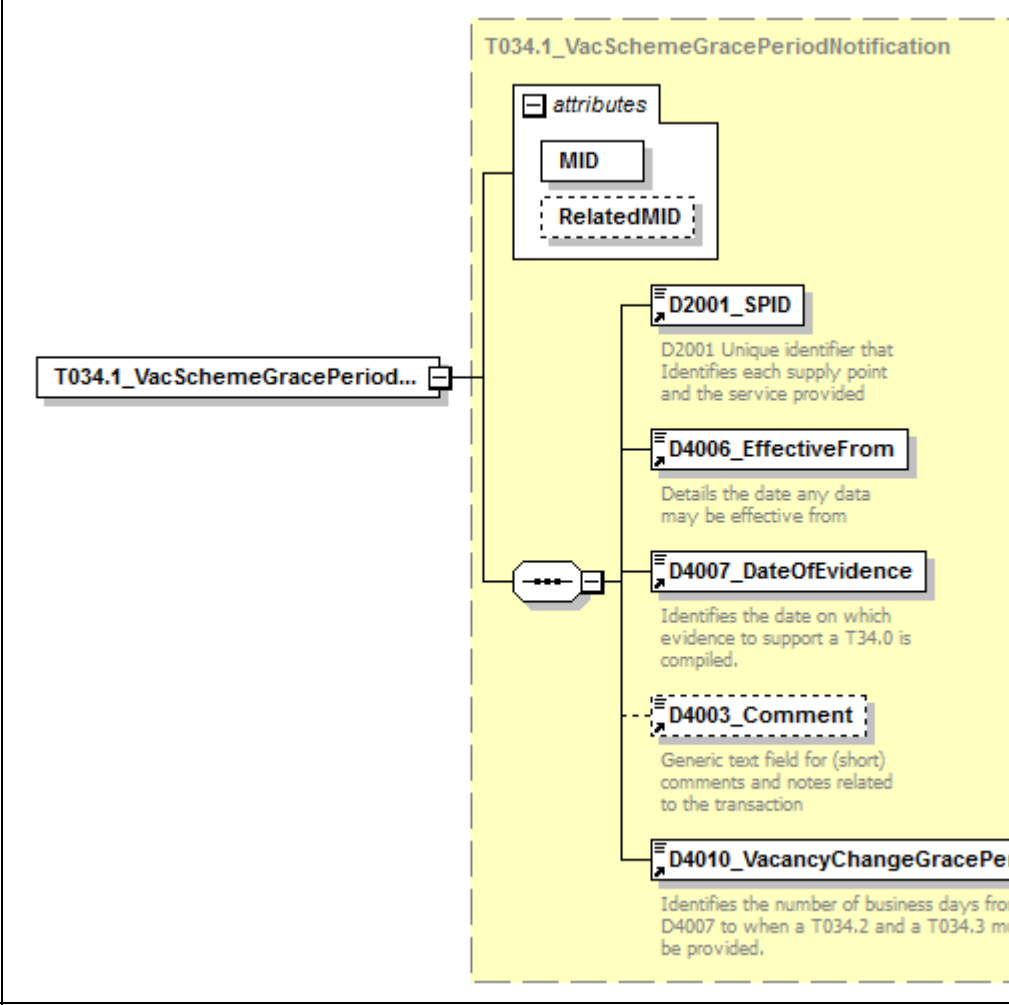
| <p>diagram</p>  | | | | | | | | | | | | | | | | | | | |
|----------------------------------------------------------------------------------------------------|--------------------------------------------------------------------------------------------------------------------------------------------------------------------------------------------------------------------------------------------------------------------------------------------------------------------------------------------------------------------------------------------------------------------------------------------|----------|---------|-------|------------|-------|------------|---------------------|-------------------------------|----------|--|--|--|----------------------------|-------------------------------|----------|--|--|--|
| <p>namespace</p> | <p>urn:bridgeall-com:cmaservice:data:v3</p> | | | | | | | | | | | | | | | | | | |
| <p>type</p> | <p>T034.1_VacSchemeGracePeriodNotification</p> | | | | | | | | | | | | | | | | | | |
| <p>properties</p> | <p>isRef 0 content complex</p> | | | | | | | | | | | | | | | | | | |
| <p>children</p> | <p>D2001_SPID D4006_EffectiveFrom D4007_DateOfEvidence D4003_Comment D4010_VacancyChangeGracePeriod</p> | | | | | | | | | | | | | | | | | | |
| <p>attributes</p> | <table border="1"> <thead> <tr> <th>Name</th> <th>Type</th> <th>Use</th> <th>Default</th> <th>Fixed</th> <th>annotation</th> </tr> </thead> <tbody> <tr> <td>MID</td> <td>MessageIdType</td> <td>required</td> <td></td> <td></td> <td></td> </tr> <tr> <td>RelatedMID</td> <td>MessageIdType</td> <td>optional</td> <td></td> <td></td> <td></td> </tr> </tbody> </table> | Name | Type | Use | Default | Fixed | annotation | MID | MessageIdType | required | | | | RelatedMID | MessageIdType | optional | | | |
| Name | Type | Use | Default | Fixed | annotation | | | | | | | | | | | | | | |
| MID | MessageIdType | required | | | | | | | | | | | | | | | | | |
| RelatedMID | MessageIdType | optional | | | | | | | | | | | | | | | | | |
| <p>source</p> | <pre><xs:element name="T034.1_VacSchemeGracePeriodNotification" type="T034.1_VacSchemeGracePeriodNotification"/></pre> | | | | | | | | | | | | | | | | | | |

element **ResponseMessagesType/T034.2_VacSchemeGraceEndNotification**

| <p>diagram</p> | <div style="border: 1px dashed black; padding: 10px;"> <p>T034.2_VacSchemeGraceEndNotification</p> <ul style="list-style-type: none"> attributes <ul style="list-style-type: none"> MID RelatedMID D2001_SPID D2001 Unique identifier that Identifies each supply point and the service provided D4006_EffectiveFrom Details the date any data may be effective from D4007_DateOfEvidence Identifies the date on which evidence to support a T34.0 is compiled. D4003_Comment Generic text field for (short) comments and notes related to the transaction D4004_ReturnCode Specifies error using code from valid set D4011_WaterSPLPOrgId The Organisation ID of an LP. Provided to SW in connection with the Vacancy Admin Charging Scheme. D4012_SewerageSPLPOrgId The Organisation ID of an LP. Provided to SW in connection with the Vacancy Admin Charging Scheme. </div> | | | | | | | | | | | | | | | | | | |
|----------------------------|-------------------------------------------------------------------------------------------------------------------------------------------------------------------------------------------------------------------------------------------------------------------------------------------------------------------------------------------------------------------------------------------------------------------------------------------------------------------------------------------------------------------------------------------------------------------------------------------------------------------------------------------------------------------------------------------------------------------------------------------------------------------------------------------------------------------------------------------------------------------------------------------------------------------------------------------------------------------------------------------------------------------------------------------------------------------------------------------------|----------|---------|-------|------------|-------|------------|---------------------|-------------------------------|----------|--|--|--|----------------------------|-------------------------------|----------|--|--|--|
| <p>namespace</p> | <p>urn:bridgeall-com:cmaservice:data:v3</p> | | | | | | | | | | | | | | | | | | |
| <p>type</p> | <p>T034.2_VacSchemeGraceEndNotification</p> | | | | | | | | | | | | | | | | | | |
| <p>properties</p> | <p>isRef 0 content complex</p> | | | | | | | | | | | | | | | | | | |
| <p>children</p> | <p>D2001_SPID D4006_EffectiveFrom D4007_DateOfEvidence D4003_Comment D4004_ReturnCode D4011_WaterSPLPOrgId D4012_SewerageSPLPOrgId</p> | | | | | | | | | | | | | | | | | | |
| <p>attributes</p> | <table border="1"> <thead> <tr> <th>Name</th> <th>Type</th> <th>Use</th> <th>Default</th> <th>Fixed</th> <th>annotation</th> </tr> </thead> <tbody> <tr> <td>MID</td> <td>MessageIdType</td> <td>required</td> <td></td> <td></td> <td></td> </tr> <tr> <td>RelatedMID</td> <td>MessageIdType</td> <td>optional</td> <td></td> <td></td> <td></td> </tr> </tbody> </table> | Name | Type | Use | Default | Fixed | annotation | MID | MessageIdType | required | | | | RelatedMID | MessageIdType | optional | | | |
| Name | Type | Use | Default | Fixed | annotation | | | | | | | | | | | | | | |
| MID | MessageIdType | required | | | | | | | | | | | | | | | | | |
| RelatedMID | MessageIdType | optional | | | | | | | | | | | | | | | | | |
| <p>source</p> | <pre><xs:element name="T034.2_VacSchemeGraceEndNotification" type="T034.2_VacSchemeGraceEndNotification"/></pre> | | | | | | | | | | | | | | | | | | |

element **ResponseMessagesType/T034.3_VacSchemeApplicationNotification**

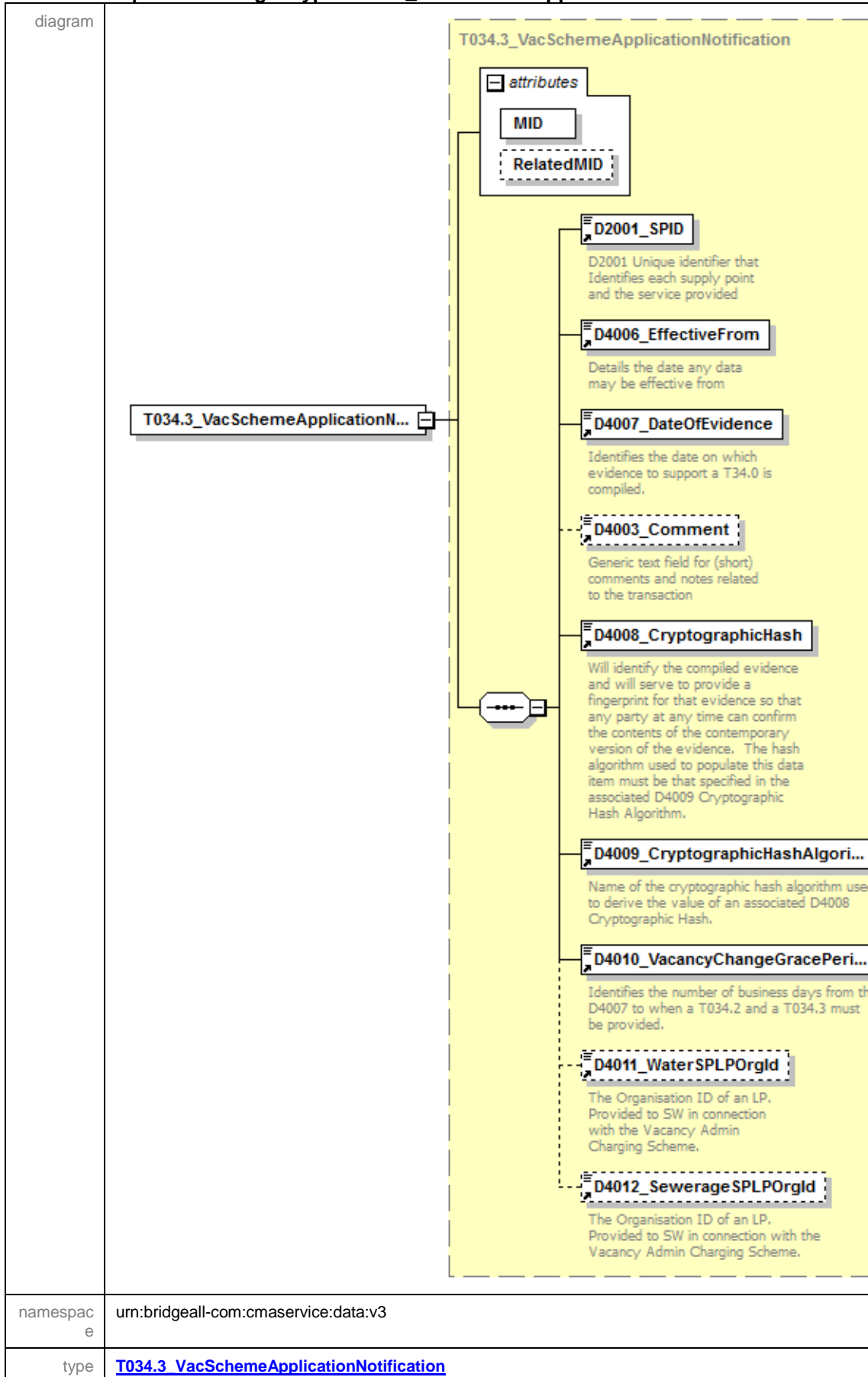

| properties | isRef 0 content complex | | | | | | | | | | | | | | | | | | |
|----------------------------|--------------------------------------------------------------------------------------------------------------------------------------------------------------------------------------------------------------------------------------------------------------------------------------------------------------------------------------------------------------------------------------------------------------------------------------------|----------|---------|-------|------------|-------|------------|---------------------|-------------------------------|----------|--|--|--|----------------------------|-------------------------------|----------|--|--|--|
| children | D2001_SPID D4006_EffectiveFrom D4007_DateOfEvidence D4003_Comment D4008_CryptographicHash D4009_CryptographicHashAlgorithm D4010_VacancyChangeGracePeriod D4011_WaterSPLPOrgld D4012_SewerageSPLPOrgld | | | | | | | | | | | | | | | | | | |
| attributes | <table border="1"> <thead> <tr> <th>Name</th> <th>Type</th> <th>Use</th> <th>Default</th> <th>Fixed</th> <th>annotation</th> </tr> </thead> <tbody> <tr> <td>MID</td> <td>MessageIdType</td> <td>required</td> <td></td> <td></td> <td></td> </tr> <tr> <td>RelatedMID</td> <td>MessageIdType</td> <td>optional</td> <td></td> <td></td> <td></td> </tr> </tbody> </table> | Name | Type | Use | Default | Fixed | annotation | MID | MessageIdType | required | | | | RelatedMID | MessageIdType | optional | | | |
| Name | Type | Use | Default | Fixed | annotation | | | | | | | | | | | | | | |
| MID | MessageIdType | required | | | | | | | | | | | | | | | | | |
| RelatedMID | MessageIdType | optional | | | | | | | | | | | | | | | | | |
| source | <code><xs:element name="T034.3_VacSchemeApplicationNotification" type="T034.3_VacSchemeApplicationNotification"/></code> | | | | | | | | | | | | | | | | | | |

element
ResponseMessagesType/T034.5_VacSchemeApplicationConfirmationOrCancellationNotification

| | |
|------------|-----------------------------------------------------------------------------------|
| diagram | |
| namespace | urn:bridgeall-com:cmaservice:data:v3 |
| type | T034.5_VacSchemeApplicationConfirmationOrCancellationNotification |
| properties | isRef 0 content complex |

| | | | | | | |
|------------|------------------------------------------------------------------------------------------------------------------------------------------------------------------------------------------------------------------------------------|-------------------------------|----------|---------|-------|------------|
| children | D2001_SPID D4006_EffectiveFrom D4007_DateOfEvidence D2031_VacancyChangeFlag D2032_LPChallengedVacancyApplicationFlag D4003_Comment | | | | | |
| attributes | Name | Type | Use | Default | Fixed | annotation |
| | MID | MessageIdType | required | | | |
| | RelatedMID | MessageIdType | optional | | | |
| source | <code><xs:element name="T034.5_VacSchemeApplicationConfirmationOrCancellationNotification" type="T034.5_VacSchemeApplicationConfirmationOrCancellationNotification"/></code> | | | | | |

element **ResponseMessagesType/T035.0_TradeabilityNotification**

| | | | | | | |
|------------|----------------------------------------------------------------------------------------------------------------|-------------------------------|----------|---------|-------|------------|
| diagram | | | | | | |
| namespace | urn:bridgeall-com:cmaservice:data:v3 | | | | | |
| type | T035.0_TradeabilityNotification | | | | | |
| properties | isRef | 0 | | | | |
| | content | complex | | | | |
| children | D2001_SPID D2013_ConnectionDate | | | | | |
| attributes | Name | Type | Use | Default | Fixed | annotation |
| | MID | MessageIdType | required | | | |
| | RelatedMID | MessageIdType | optional | | | |
| source | <code><xs:element name="T035.0_TradeabilityNotification" type="T035.0_TradeabilityNotification"/></code> | | | | | |

element **ResponseMessagesType/T035.1_TradeabilityNotification**

| <p>diagram</p> | | | | | | | | | | | | | | | | | | | |
|----------------------------|--------------------------------------------------------------------------------------------------------------------------------------------------------------------------------------------------------------------------------------------------------------------------------------------------------------------------------------------------------------------------------------------------------------------------------------------|----------|---------|-------|------------|-------|------------|---------------------|-------------------------------|----------|--|--|--|----------------------------|-------------------------------|----------|--|--|--|
| <p>namespace</p> | <p>urn:bridgeall-com:cmaservice:data:v3</p> | | | | | | | | | | | | | | | | | | |
| <p>type</p> | <p>T035.1_TradeabilityNotification</p> | | | | | | | | | | | | | | | | | | |
| <p>properties</p> | <p>isRef 0 content complex</p> | | | | | | | | | | | | | | | | | | |
| <p>children</p> | <p>D2001_SPID D2013_ConnectionDate</p> | | | | | | | | | | | | | | | | | | |
| <p>attributes</p> | <table border="1"> <thead> <tr> <th>Name</th> <th>Type</th> <th>Use</th> <th>Default</th> <th>Fixed</th> <th>annotation</th> </tr> </thead> <tbody> <tr> <td>MID</td> <td>MessageIdType</td> <td>required</td> <td></td> <td></td> <td></td> </tr> <tr> <td>RelatedMID</td> <td>MessageIdType</td> <td>optional</td> <td></td> <td></td> <td></td> </tr> </tbody> </table> | Name | Type | Use | Default | Fixed | annotation | MID | MessageIdType | required | | | | RelatedMID | MessageIdType | optional | | | |
| Name | Type | Use | Default | Fixed | annotation | | | | | | | | | | | | | | |
| MID | MessageIdType | required | | | | | | | | | | | | | | | | | |
| RelatedMID | MessageIdType | optional | | | | | | | | | | | | | | | | | |
| <p>source</p> | <pre><xs:element name="T035.1_TradeabilityNotification" type="T035.1_TradeabilityNotification"/></pre> | | | | | | | | | | | | | | | | | | |

element **ResponseMessagesType/T036.1_MeterNetworkAssociationNotification**

| <p>diagram</p> | | | | | | | | | | | | | | | | | | | |
|----------------------------|--------------------------------------------------------------------------------------------------------------------------------------------------------------------------------------------------------------------------------------------------------------------------------------------------------------------------------------------------------------------------------------------------------------------------------------------|----------|---------|-------|------------|-------|------------|---------------------|-------------------------------|----------|--|--|--|----------------------------|-------------------------------|----------|--|--|--|
| <p>namespace</p> | <p>urn:bridgeall-com:cmaservice:data:v3</p> | | | | | | | | | | | | | | | | | | |
| <p>type</p> | <p>MeterNetworkAssociationType</p> | | | | | | | | | | | | | | | | | | |
| <p>properties</p> | <p>isRef 0 content complex</p> | | | | | | | | | | | | | | | | | | |
| <p>children</p> | <p>D2035_MainSPID D3027_MainMeterId D2036_SubSPID D3006_SubMeterId D3026_MeterNetworkAssociati... D4006_EffectiveFrom</p> | | | | | | | | | | | | | | | | | | |
| <p>attributes</p> | <table border="1"> <thead> <tr> <th>Name</th> <th>Type</th> <th>Use</th> <th>Default</th> <th>Fixed</th> <th>annotation</th> </tr> </thead> <tbody> <tr> <td>MID</td> <td>MessageIdType</td> <td>required</td> <td></td> <td></td> <td></td> </tr> <tr> <td>RelatedMID</td> <td>MessageIdType</td> <td>optional</td> <td></td> <td></td> <td></td> </tr> </tbody> </table> | Name | Type | Use | Default | Fixed | annotation | MID | MessageIdType | required | | | | RelatedMID | MessageIdType | optional | | | |
| Name | Type | Use | Default | Fixed | annotation | | | | | | | | | | | | | | |
| MID | MessageIdType | required | | | | | | | | | | | | | | | | | |
| RelatedMID | MessageIdType | optional | | | | | | | | | | | | | | | | | |
| <p>source</p> | <pre><xs:element name="T036.1_MeterNetworkAssociationNotification" type="MeterNetworkAssociationType"/></pre> | | | | | | | | | | | | | | | | | | |

complexType **Schedule3UpdateType**

| <p>diagram</p> | <p>The diagram shows the structure of the Schedule3UpdateType complex type. It is an extension of the MessageBody type. The MessageBody extension contains an attributes container with two elements: MID (required) and RelatedMID (optional). The Schedule3UpdateType contains a sequence of four elements: D2001_SPID (required), D2003_Schedule3 (required), D4006_EffectiveFrom (required), and D6001_DPID (required). The descriptions for these elements are: D2001_SPID: D2001 Unique identifier that Identifies each supply point and the service provided; D2003_Schedule3: Schedule 3 percentage discount applied to service element; D4006_EffectiveFrom: Details the date any data may be effective from; D6001_DPID: Discharge Point ID.</p> | | | | | | | | | | | | | | | | | | |
|----------------------------|---------------------------------------------------------------------------------------------------------------------------------------------------------------------------------------------------------------------------------------------------------------------------------------------------------------------------------------------------------------------------------------------------------------------------------------------------------------------------------------------------------------------------------------------------------------------------------------------------------------------------------------------------------------------------------------------------------------------------------------------------------------------------------------------------------------------------------------------------------------------|----------|---------|-------|------------|-------|------------|---------------------|-------------------------------|----------|--|--|--|----------------------------|-------------------------------|----------|--|--|--|
| <p>namespace</p> | <p>urn:bridgeall-com:cmaservice:data:v3</p> | | | | | | | | | | | | | | | | | | |
| <p>type</p> | <p>extension of MessageBody</p> | | | | | | | | | | | | | | | | | | |
| <p>properties</p> | <p>base MessageBody</p> | | | | | | | | | | | | | | | | | | |
| <p>children</p> | <p>D2001_SPID D2003_Schedule3 D4006_EffectiveFrom D6001_DPID</p> | | | | | | | | | | | | | | | | | | |
| <p>used by</p> | <p>elements ResponseMessagesType/T028.0_Schedule3UpdateNotification MessagesType/T028.1_Schedule3Updates/T028.1_Schedule3Update</p> | | | | | | | | | | | | | | | | | | |
| <p>attributes</p> | <table border="1"> <thead> <tr> <th>Name</th> <th>Type</th> <th>Use</th> <th>Default</th> <th>Fixed</th> <th>annotation</th> </tr> </thead> <tbody> <tr> <td>MID</td> <td>MessageIdType</td> <td>required</td> <td></td> <td></td> <td></td> </tr> <tr> <td>RelatedMID</td> <td>MessageIdType</td> <td>optional</td> <td></td> <td></td> <td></td> </tr> </tbody> </table> | Name | Type | Use | Default | Fixed | annotation | MID | MessageIdType | required | | | | RelatedMID | MessageIdType | optional | | | |
| Name | Type | Use | Default | Fixed | annotation | | | | | | | | | | | | | | |
| MID | MessageIdType | required | | | | | | | | | | | | | | | | | |
| RelatedMID | MessageIdType | optional | | | | | | | | | | | | | | | | | |
| <p>annotation</p> | <p>documentation</p> | | | | | | | | | | | | | | | | | | |
| <p>source</p> | <pre><xs:complexType name="Schedule3UpdateType"> <xs:annotation> <xs:documentation> </xs:documentation> </xs:annotation> <xs:complexContent> <xs:extension base="MessageBody"> <xs:sequence> <xs:element ref="D2001_SPID"/> <xs:element ref="D2003_Schedule3"/> <xs:element ref="D4006_EffectiveFrom"/> <xs:element ref="D6001_DPID"/> </xs:sequence> </xs:extension> </xs:complexContent> </xs:complexType></pre> | | | | | | | | | | | | | | | | | | |

complexType **ServiceElementUpdateNotificationType**

| <p>diagram</p> | | | | | | | | | | | | | | | | | | | |
|----------------------------|-------------------------------------------------------------------------------------------------------------------------------------------------------------------------------------------------------------------------------------------------------------------------------------------------------------------------------------------------------------------------------------------------------------------------------------------------------------------------------------------------------------------------------------------------------------------------------------------------------------------------------------------------------|----------|---------|-------|------------|-------|------------|---------------------|-------------------------------|----------|--|--|--|----------------------------|-------------------------------|----------|--|--|--|
| <p>namespace</p> | <p>urn:bridgeall-com:cmaservice:data:v3</p> | | | | | | | | | | | | | | | | | | |
| <p>type</p> | <p>extension of MessageBody</p> | | | | | | | | | | | | | | | | | | |
| <p>properties</p> | <p>base MessageBody</p> | | | | | | | | | | | | | | | | | | |
| <p>children</p> | <p>D2001_SPID D2015_SPIDVacant D4006_EffectiveFrom D4003_Comment</p> | | | | | | | | | | | | | | | | | | |
| <p>used by</p> | <p>element ResponseMessagesType/T012.2_ServiceElementUpdateNotification</p> | | | | | | | | | | | | | | | | | | |
| <p>attributes</p> | <table border="1"> <thead> <tr> <th>Name</th> <th>Type</th> <th>Use</th> <th>Default</th> <th>Fixed</th> <th>annotation</th> </tr> </thead> <tbody> <tr> <td>MID</td> <td>MessageIdType</td> <td>required</td> <td></td> <td></td> <td></td> </tr> <tr> <td>RelatedMID</td> <td>MessageIdType</td> <td>optional</td> <td></td> <td></td> <td></td> </tr> </tbody> </table> | Name | Type | Use | Default | Fixed | annotation | MID | MessageIdType | required | | | | RelatedMID | MessageIdType | optional | | | |
| Name | Type | Use | Default | Fixed | annotation | | | | | | | | | | | | | | |
| MID | MessageIdType | required | | | | | | | | | | | | | | | | | |
| RelatedMID | MessageIdType | optional | | | | | | | | | | | | | | | | | |
| <p>annotation</p> | <p>documentation</p> | | | | | | | | | | | | | | | | | | |
| <p>source</p> | <pre> <xs:complexType name="ServiceElementUpdateNotificationType"> <xs:annotation> <xs:documentation> </xs:documentation> </xs:annotation> <xs:complexContent> <xs:extension base="MessageBody"> <xs:sequence> <xs:element ref="D2001_SPID"/> <xs:element ref="D2015_SPIDVacant" minOccurs="0"/> <xs:element ref="D4006_EffectiveFrom"/> <xs:element ref="D4003_Comment"/> </xs:sequence> </xs:extension> </xs:complexContent> </xs:complexType> </pre> | | | | | | | | | | | | | | | | | | |

complexType **SewerageServiceElementUpdateNotificationType**

| | | | | | | |
|------------|----------------------------------------------------------------------------------------------------------------------------------------------------------------------------------------------------------------------------------------------------------------------------------------------------------------------------------------------------------------------------------------------------------------------------------------------------------------------------------|-------------------------------|----------|---------|-------|------------|
| diagram | | | | | | |
| namespace | urn:bridgeall-com:cmaservice:data:v3 | | | | | |
| type | extension of MessageBody | | | | | |
| properties | base MessageBody | | | | | |
| children | D2001_SPID D4006_EffectiveFrom D2016_PropertyDrainage D2017_RoadDrainage D4003_Comment | | | | | |
| used by | element ResponseMessagesType/T012.4 SewerageServiceElementUpdateNotification | | | | | |
| attributes | Name | Type | Use | Default | Fixed | annotation |
| | MID | MessageIdType | required | | | |
| | RelatedMID | MessageIdType | optional | | | |
| annotation | documentation | | | | | |
| source | <pre> <xs:complexType name="SewerageServiceElementUpdateNotificationType"> <xs:annotation> <xs:documentation> </xs:documentation> </xs:annotation> <xs:complexContent> <xs:extension base="MessageBody"> <xs:sequence> <xs:element ref="D2001_SPID"/> </xs:sequence> </xs:extension> </xs:complexContent> </xs:complexType> </pre> | | | | | |

```

<xs:element ref="D4006_EffectiveFrom"/>
<xs:element ref="D2016_PropertyDrainage" minOccurs="0"/>
<xs:element ref="D2017_RoadDrainage" minOccurs="0"/>
<xs:element ref="D4003_Comment"/>
</xs:sequence>
</xs:extension>
</xs:complexContent>
</xs:complexType>

```

complexType **SewerageSPIDDataType**

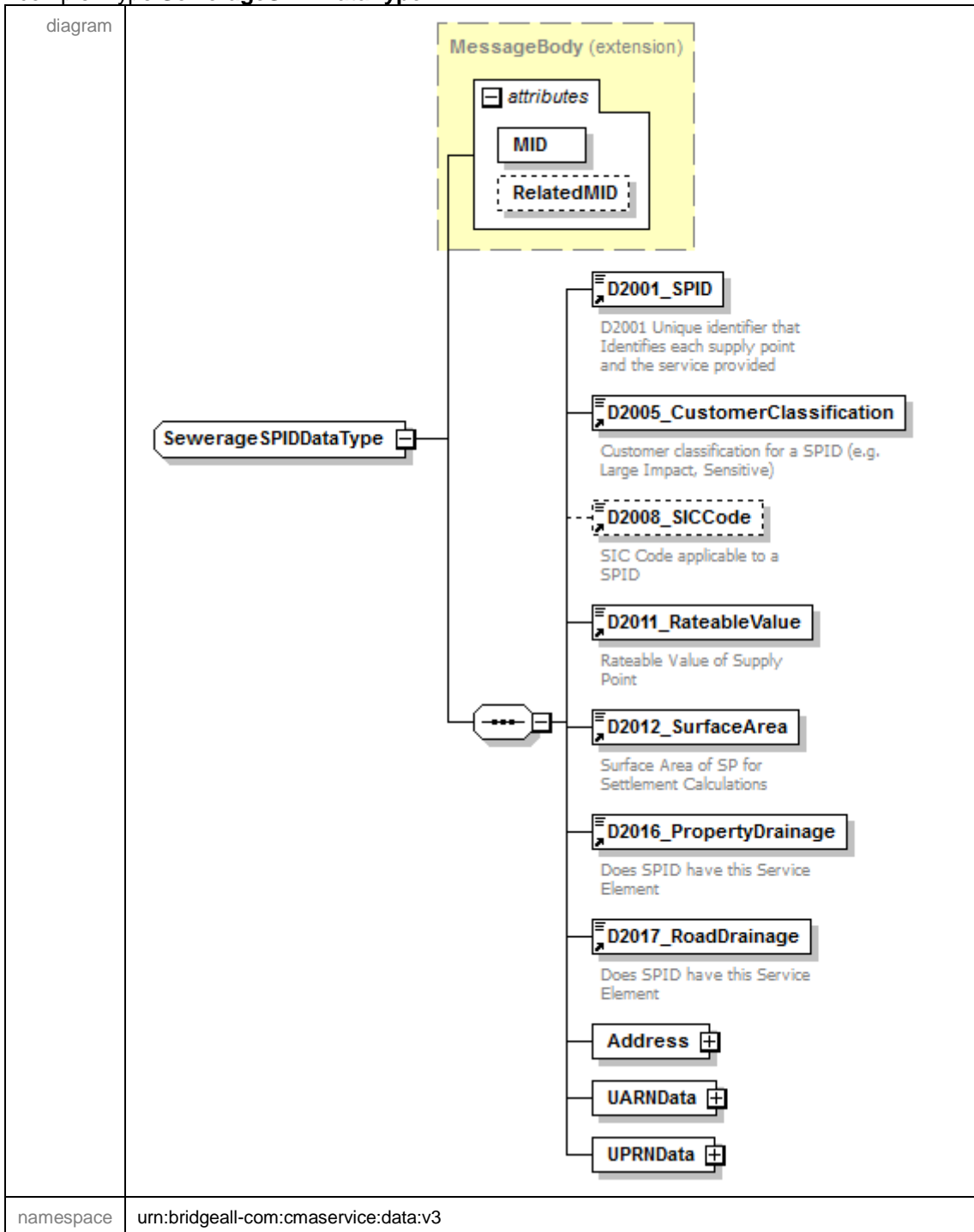

| | | | | | | |
|------------|-------------------------------------------------------------------------------------------------------------------------------------------------------------------------------------------------------------------------------------------------------------------------------------------------------------------------------------------------------------------------------------------------------------------------------------------------------------------------------------------------------------------------------------------------------------------------------------------------------------------------------------------------------------------------------------------------------------------------------------------------------------------------------------------------------------------------------------------------------------------------------------------------------------------------------------------------------------------------------------------------------------------------|-------------------------------|----------|---------|-------|------------|
| type | extension of MessageBody | | | | | |
| properties | base MessageBody | | | | | |
| children | D2001_SPID D2005_CustomerClassification D2008_SICCode D2011_RateableValue D2012_SurfaceArea D2016_PropertyDrainage D2017_RoadDrainage Address UARNDData UPRNDData | | | | | |
| used by | element ResponseMessagesType/T020.0_SewerageSPIDData | | | | | |
| attributes | Name | Type | Use | Default | Fixed | annotation |
| | MID | MessageIdType | required | | | |
| | RelatedMID | MessageIdType | optional | | | |
| annotation | documentation | | | | | |
| source | <pre> <xs:complexType name="SewerageSPIDDataType"> <xs:annotation> <xs:documentation> </xs:documentation> </xs:annotation> <xs:complexContent> <xs:extension base="MessageBody"> <xs:sequence> <xs:element ref="D2001_SPID"/> <xs:element ref="D2005_CustomerClassification"/> <xs:element ref="D2008_SICCode" minOccurs="0"/> <xs:element ref="D2011_RateableValue"/> <xs:element ref="D2012_SurfaceArea"/> <xs:element ref="D2016_PropertyDrainage"/> <xs:element ref="D2017_RoadDrainage"/> <xs:element name="Address" type="AddressType"/> <xs:element name="UARNDData" type="UARNTYPE"/> <xs:element name="UPRNDData" type="UPRNTYPE"/> </xs:sequence> </xs:extension> </xs:complexContent> </xs:complexType> </pre> | | | | | |

element **SewerageSPIDDataType/Address**

| | |
|-------------------|--------------------------------------------------------------------------------------------------------------------------------------------------------------------------------------------------------------------------------------------------------------------------------------------------------------------------------------------------------------------------------------------------------------------------------------------------------------------------------------------------------------------------------------|
| <p>diagram</p> | |
| <p>namespace</p> | <p>urn:bridgeall-com:cmaservice:data:v3</p> |
| <p>type</p> | <p>AddressType</p> |
| <p>properties</p> | <p>isRef 0 content complex</p> |
| <p>children</p> | <p>D5001_FreeDescriptor D5002_SubBuildingName D5003_BuildingName D5004_BuildingNumber D5005_DependentThoroughfareName D5006_DependentThoroughfareDescriptor D5007_ThoroughfareName D5008_ThoroughfareDescriptor D5009_DoubleDependentLocality D5010_DependentLocality D5011_PostTown D5012_County D5013_Postcode</p> |
| <p>source</p> | <p><xs:element name="Address" type="AddressType"/></p> |

element **SewerageSPIDDataType/UARNDData**

| | |
|-------------------|---------------------------------------------|
| <p>diagram</p> | |
| <p>namespace</p> | <p>urn:bridgeall-com:cmaservice:data:v3</p> |
| <p>type</p> | <p>UARNTType</p> |
| <p>properties</p> | <p>isRef 0 content complex</p> |

| | |
|----------|----------------------------------------------------------------------------------------------|
| children | D2037 SAAReferenceNumber D2038 SAAReferenceNumberAbsenceCode |
| source | <code><xs:element name="UARNDData" type="UARNTYPE"/></code> |

element **SewerageSPIDData/UPRNDData**

| | |
|------------|-----------------------------------------------------------------------------------------------------------------------------------------------------------------------------------------------------------------------------------------------------------------------------------------------------------------------------------------------------------------------------------------------------------------------------------------------------------------------------------------------------------------------------------------------------------------------------------------------------------------------------------------|
| diagram | <p>The diagram illustrates the relationship between the UPRNDData element and the UPRNTYPE base type. UPRNDData is shown as a complex type that inherits from UPRNTYPE. UPRNTYPE is a base class that contains two subclasses: D2039_UPRN and D2040_UPRNBsenceCode. The UPRNDData element is shown as a box with a small square on its right side, indicating it is a complex type. The UPRNTYPE base type is shown as a box with a small square on its right side, indicating it is a base type. The two subclasses are shown as dashed boxes with small squares on their right sides, indicating they are subclasses of UPRNTYPE.</p> |
| namespace | urn:bridgeall-com:cmaservice:data:v3 |
| type | UPRNTYPE |
| properties | isRef 0 content complex |
| children | D2039 UPRN D2040 UPRNBsenceCode |
| source | <code><xs:element name="UPRNDData" type="UPRNTYPE"/></code> |

complexType **SpecialArrangementsUpdateNotificationType**

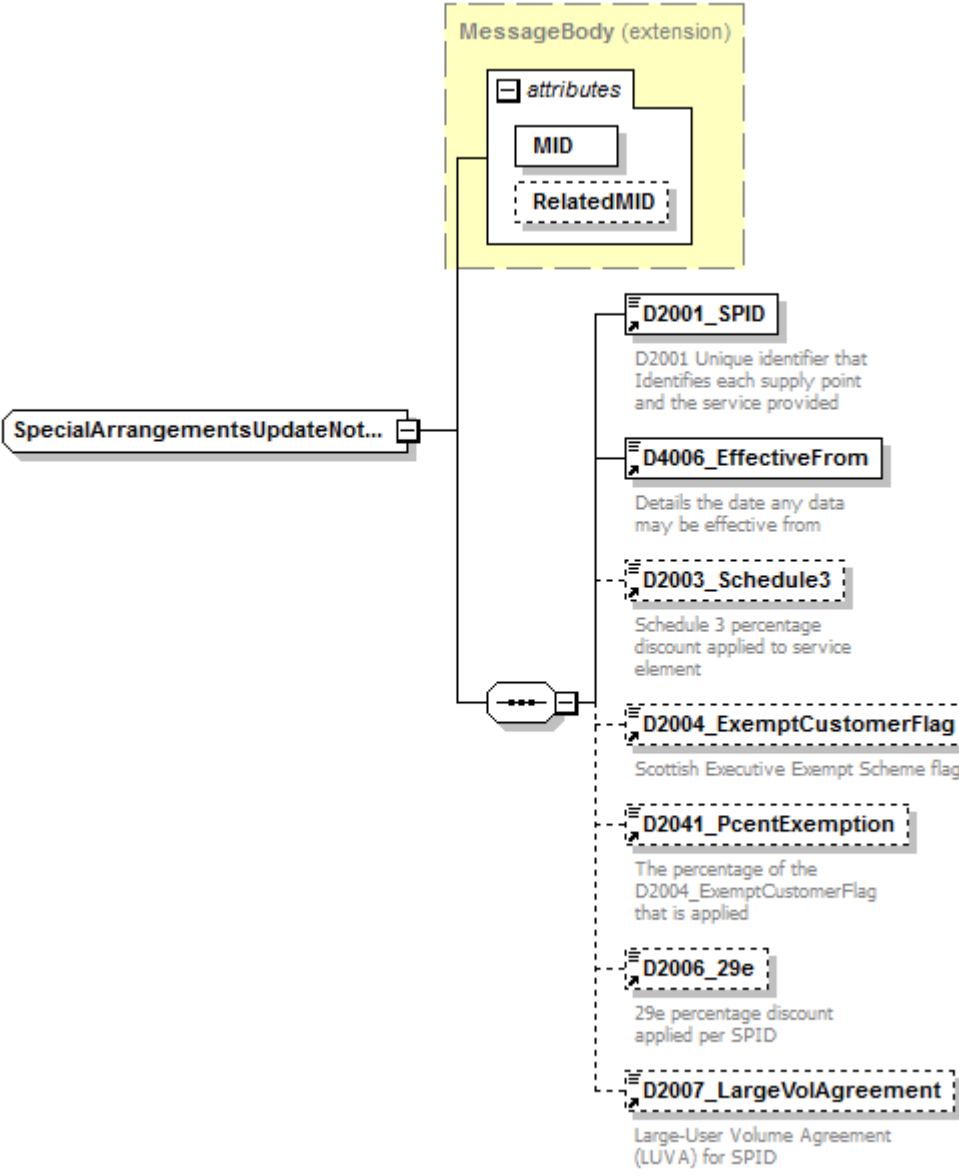
| <p>diagram</p> |  | | | | | | | | | | | | | | | | | | |
|----------------------------|--------------------------------------------------------------------------------------------------------------------------------------------------------------------------------------------------------------------------------------------------------------------------------------------------------------------------------------------------------------------------------------------------------------------------------------------|----------|---------|-------|------------|-------|------------|---------------------|-------------------------------|----------|--|--|--|----------------------------|-------------------------------|----------|--|--|--|
| <p>namespace</p> | <p>urn:bridgeall-com:cmaservice:data:v3</p> | | | | | | | | | | | | | | | | | | |
| <p>type</p> | <p>extension of MessageBody</p> | | | | | | | | | | | | | | | | | | |
| <p>properties</p> | <p>base MessageBody</p> | | | | | | | | | | | | | | | | | | |
| <p>children</p> | <p>D2001_SPID D4006_EffectiveFrom D2003_Schedule3 D2004_ExemptCustomerFlag D2041_PcentExemption D2006_29e D2007_LargeVolAgreement</p> | | | | | | | | | | | | | | | | | | |
| <p>used by</p> | <p>element ResponseMessagesType/T029.0_SpecialArrangementsUpdateNotification</p> | | | | | | | | | | | | | | | | | | |
| <p>attributes</p> | <table border="1"> <thead> <tr> <th>Name</th> <th>Type</th> <th>Use</th> <th>Default</th> <th>Fixed</th> <th>annotation</th> </tr> </thead> <tbody> <tr> <td>MID</td> <td>MessageIdType</td> <td>required</td> <td></td> <td></td> <td></td> </tr> <tr> <td>RelatedMID</td> <td>MessageIdType</td> <td>optional</td> <td></td> <td></td> <td></td> </tr> </tbody> </table> | Name | Type | Use | Default | Fixed | annotation | MID | MessageIdType | required | | | | RelatedMID | MessageIdType | optional | | | |
| Name | Type | Use | Default | Fixed | annotation | | | | | | | | | | | | | | |
| MID | MessageIdType | required | | | | | | | | | | | | | | | | | |
| RelatedMID | MessageIdType | optional | | | | | | | | | | | | | | | | | |
| <p>annotation</p> | <p>documentation</p> | | | | | | | | | | | | | | | | | | |
| <p>source</p> | <pre><xs:complexType name="SpecialArrangementsUpdateNotificationType"> <xs:annotation> <xs:documentation> </xs:documentation></pre> | | | | | | | | | | | | | | | | | | |

```

</xs:annotation>
<xs:complexContent>
  <xs:extension base="MessageBody">
    <xs:sequence>
      <xs:element ref="D2001_SPID"/>
      <xs:element ref="D4006_EffectiveFrom"/>
      <xs:element ref="D2003_Schedule3" minOccurs="0"/>
      <xs:element ref="D2004_ExemptCustomerFlag" minOccurs="0"/>
      <xs:element ref="D2041_PcentExemption" minOccurs="0"/>
      <xs:element ref="D2006_29e" minOccurs="0"/>
      <xs:element ref="D2007_LargeVolAgreement" minOccurs="0"/>
    </xs:sequence>
  </xs:extension>
</xs:complexContent>
</xs:complexType>

```

complexType **SpecialArrangementsUpdateType**

| | |
|------------|------------------------------------------------------------------------------------------------------------------------------------------------------------------|
| diagram | |
| namespace | urn:bridgeall-com:cmaservice:data:v3 |
| type | extension of MessageBody |
| properties | base MessageBody |
| children | D2001_SPID D4006_EffectiveFrom D2003_Schedule3 D2006_29e D2007_LargeVolAgreement |
| used by | element MessagesType/T029.1_SpecialArrangementsUpdates/T029.1_SpecialArrangementsUpdate |

| | | | | | | |
|------------|-----------------------------------------------------------------------------------------------------------------------------------------------------------------------------------------------------------------------------------------------------------------------------------------------------------------------------------------------------------------------------------------------------------------------------------------------------------------------------------------------------------------------------------------------------------------------------------------------------------------------------------------------------------------------------------------------------------------------------------|------------------------------------------------------------------------|-----------------------------|---------|-------|------------|
| attributes | Name MID RelatedMID | Type MessageIdType MessageIdType | Use required optional | Default | Fixed | annotation |
| annotation | documentation | | | | | |
| source | <pre> <xs:complexType name="SpecialArrangementsUpdateType"> <xs:annotation> <xs:documentation> </xs:documentation> </xs:annotation> <xs:complexContent> <xs:extension base="MessageBody"> <xs:sequence> <xs:element ref="D2001_SPID"/> <xs:element ref="D4006_EffectiveFrom"/> <xs:element ref="D2003_Schedule3" minOccurs="0"/> <xs:element ref="D2006_29e" minOccurs="0"/> <xs:element ref="D2007_LargeVolAgreement" minOccurs="0"/> </xs:sequence> </xs:extension> </xs:complexContent> </xs:complexType> </pre> | | | | | |

complexType T003.1_RegistrationApplicationType

| | | | | | | |
|------------|-----------------------------------------------------------------------------------------------------|------------------------------------------------------------------------|-----------------------------|---------|-------|------------|
| diagram | | | | | | |
| namespace | urn:bridgeall-com:cmaservice:data:v3 | | | | | |
| type | extension of MessageBody | | | | | |
| properties | base MessageBody | | | | | |
| children | D2001_SPID D4002_RegistrationStartDate | | | | | |
| used by | element MessagesType/T003.1_RegistrationApplications/T003.1_RegistrationApplication | | | | | |
| attributes | Name MID RelatedMID | Type MessageIdType MessageIdType | Use required optional | Default | Fixed | annotation |
| annotation | documentation | | | | | |

| | |
|--------|--------------------------------------------------------------------------------------------------------------------------------------------------------------------------------------------------------------------------------------------------------------------------------------------------------------------------------------------------------------------------------------------------------------------------------------------------------------------------------------------------------------------|
| | |
| source | <pre><xs:complexType name="T003.1_RegistrationApplicationType"> <xs:annotation> <xs:documentation> </xs:documentation> </xs:annotation> <xs:complexContent> <xs:extension base="MessageBody"> <xs:sequence> <xs:element ref="D2001_SPID"/> <xs:element ref="D4002_RegistrationStartDate"/> </xs:sequence> </xs:extension> </xs:complexContent> </xs:complexType></pre> |

complexType T004.0_NewMeterType

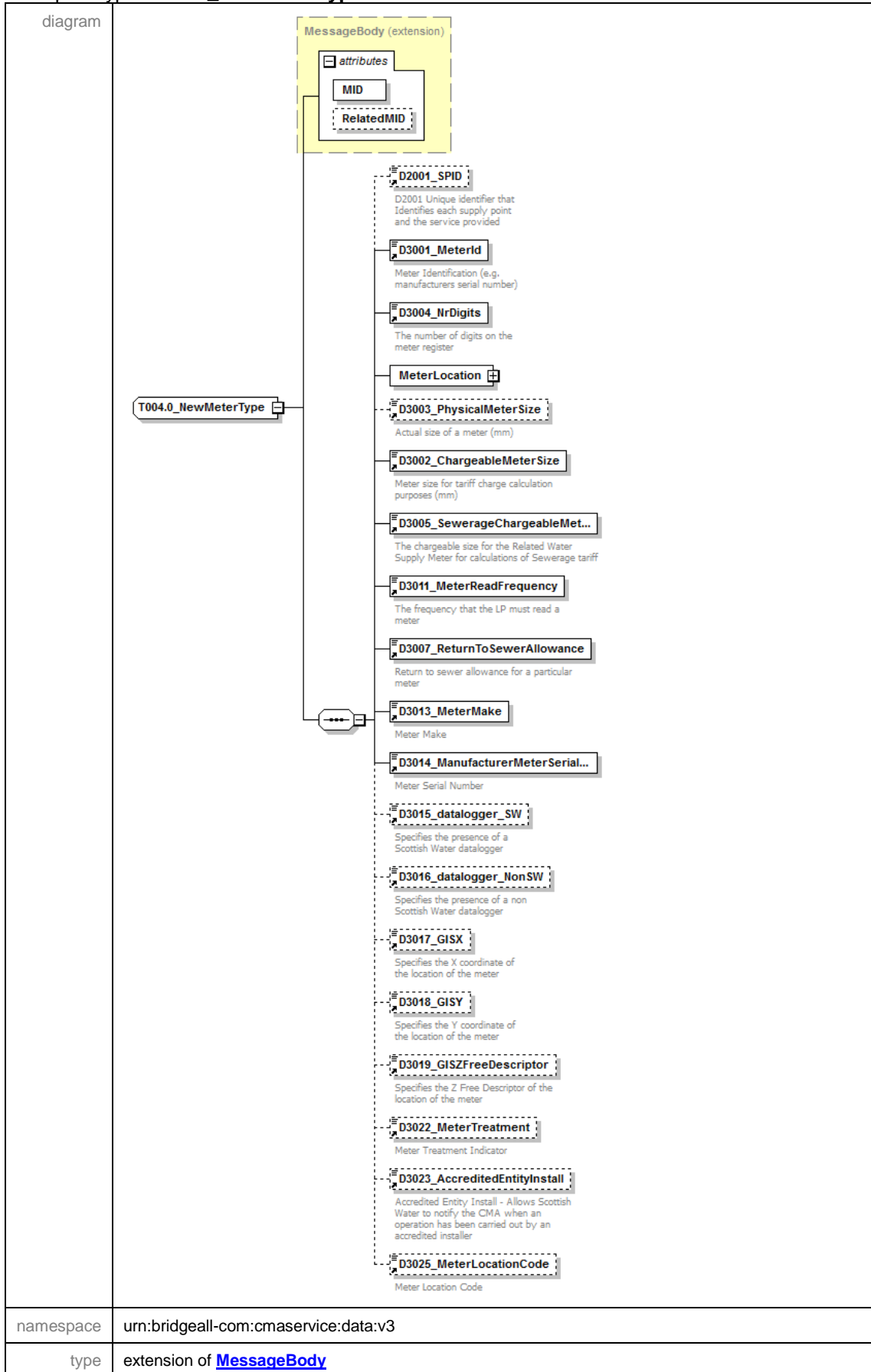

| | | | | | | |
|------------|-----------------------------------------------------------------------------------------------------------------------------------------------------------------------------------------------------------------------------------------------------------------------------------------------------------------------------------------------------------------------------------------------------------------------------------------------------------------------------------------------------------------------------------------------------------------------------------------------------------------------------------------------------------------------------------------------------------------------------------------------------------------------------------------------------------------------------------------------------------------------------------------------------------------------------------------------------------------------------------------------------------------------------------------------------------------------------------------------------------------------------------------------------------------------------------------------------------------------------------------------------------------------------------------------------------------------------------------------------------------------------------------------------------------------------------------------------------------------------------------------------------------------------------------------------------------------------------------------------------------------------------------------------------------------------------------------------------|-------------------------------|----------|---------|-------|------------|
| properties | base MessageBody | | | | | |
| children | D2001_SPID D3001_MeterId D3004_NrDigits MeterLocation D3003_PhysicalMeterSize D3002_ChargeableMeterSize D3005_SewerageChargeableMeterSize D3011_MeterReadFrequency D3007_ReturnToSewerAllowance D3013_MeterMake D3014_ManufacturerMeterSerialNr D3015_datalogger_SW D3016_datalogger_NonSW D3017_GISX D3018_GISY D3019_GISZFreeDescriptor D3022_MeterTreatment D3023_AccreditedEntityInstall D3025_MeterLocationCode | | | | | |
| used by | element MessagesType/T004.0_NewMeters/T004.0_NewMeter | | | | | |
| attributes | Name | Type | Use | Default | Fixed | annotation |
| | MID | MessageIdType | required | | | |
| | RelatedMID | MessageIdType | optional | | | |
| annotation | documentation | | | | | |
| source | <pre> <xs:complexType name="T004.0_NewMeterType"> <xs:annotation> <xs:documentation> </xs:documentation> </xs:annotation> <xs:complexContent> <xs:extension base="MessageBody"> <xs:sequence> <xs:element ref="D2001_SPID" minOccurs="0"/> <xs:element ref="D3001_MeterId"/> <xs:element ref="D3004_NrDigits"/> <xs:element name="MeterLocation" type="AddressType"/> <xs:element ref="D3003_PhysicalMeterSize" minOccurs="0"/> <xs:element ref="D3002_ChargeableMeterSize"/> <xs:element ref="D3005_SewerageChargeableMeterSize"/> <xs:element ref="D3011_MeterReadFrequency"/> <xs:element ref="D3007_ReturnToSewerAllowance"/> <xs:element ref="D3013_MeterMake"/> <xs:element ref="D3014_ManufacturerMeterSerialNr"/> <xs:element ref="D3015_datalogger_SW" minOccurs="0"/> <xs:element ref="D3016_datalogger_NonSW" minOccurs="0"/> <xs:element ref="D3017_GISX" minOccurs="0"/> <xs:element ref="D3018_GISY" minOccurs="0"/> <xs:element ref="D3019_GISZFreeDescriptor" minOccurs="0"/> <xs:element ref="D3022_MeterTreatment" minOccurs="0"/> <xs:element ref="D3023_AccreditedEntityInstall" minOccurs="0"/> <xs:element ref="D3025_MeterLocationCode" minOccurs="0"/> </xs:sequence> </xs:extension> </xs:complexContent> </xs:complexType> </pre> | | | | | |

element **T004.0_NewMeterType/MeterLocation**

| | |
|-------------------|--------------------------------------------------------------------------------------------------------------------------------------------------------------------------------------------------------------------------------------------------------------------------------------------------------------------------------------------------------------------------------------------------------------------------------------------------------------------------------------------------------------------------------------|
| <p>diagram</p> | |
| <p>namespace</p> | <p>urn:bridgeall-com:cmaservice:data:v3</p> |
| <p>type</p> | <p>AddressType</p> |
| <p>properties</p> | <p>isRef 0 content complex</p> |
| <p>children</p> | <p>D5001_FreeDescriptor D5002_SubBuildingName D5003_BuildingName D5004_BuildingNumber D5005_DependentThoroughfareName D5006_DependentThoroughfareDescriptor D5007_ThoroughfareName D5008_ThoroughfareDescriptor D5009_DoubleDependentLocality D5010_DependentLocality D5011_PostTown D5012_County D5013_Postcode</p> |
| <p>source</p> | <p><xs:element name="MeterLocation" type="AddressType"/></p> |

complexType **T004.1_NewMeterNotificationType**

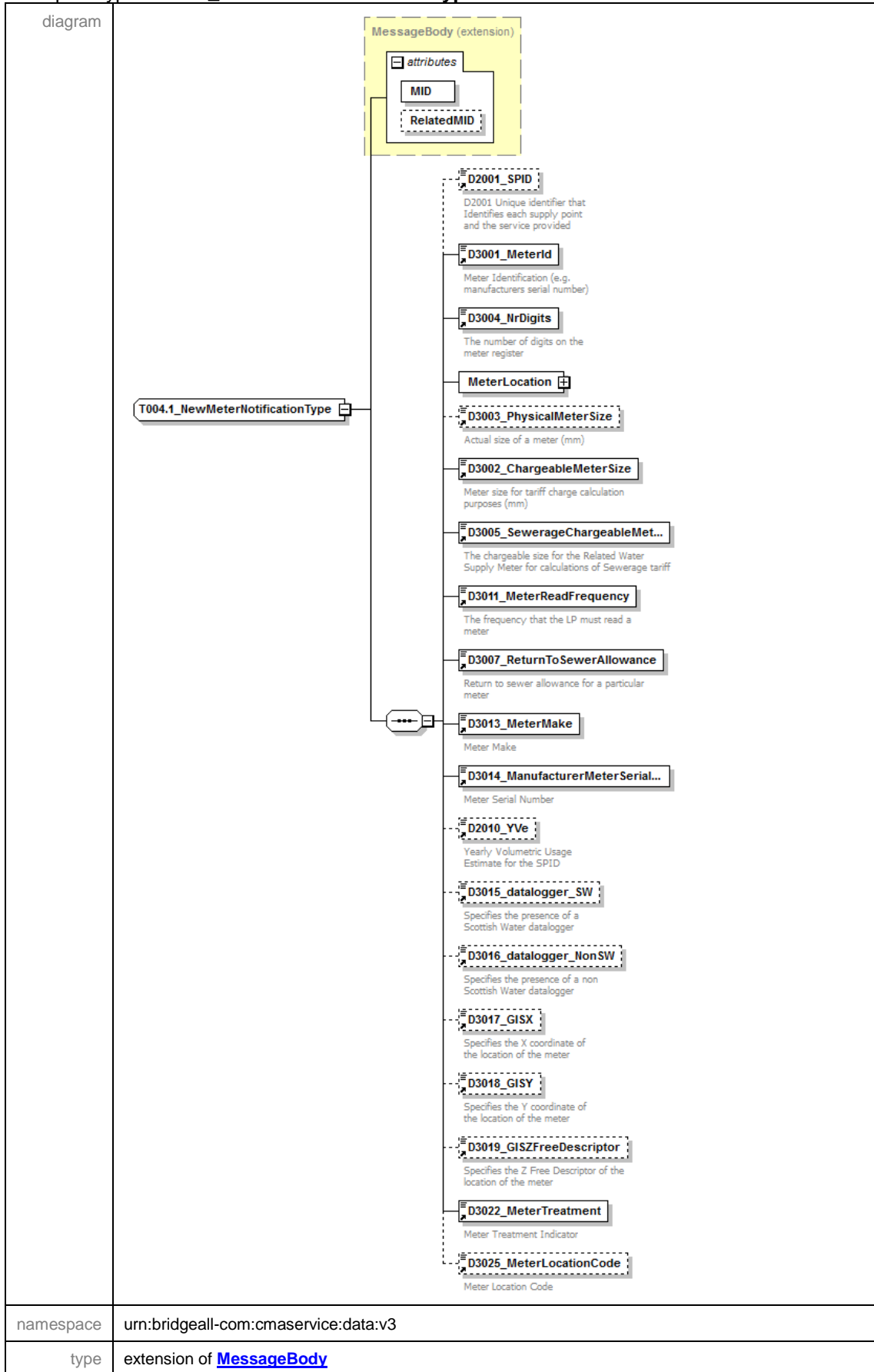

| | | | | | | |
|------------|-------------------------------------------------------------------------------------------------------------------------------------------------------------------------------------------------------------------------------------------------------------------------------------------------------------------------------------------------------------------------------------------------------------------------------------------------------------------------------------------------------------------------------------------------------------------------------------------------------------------------------------------------------------------------------------------------------------------------------------------------------------------------------------------------------------------------------------------------------------------------------------------------------------------------------------------------------------------------------------------------------------------------------------------------------------------------------------------------------------------------------------------------------------------------------------------------------------------------------------------------------------------------------------------------------------------------------------------------------------------------------------------------------------------------------------------------------------------------------------------------------------------------------------------------------------------------------------------------------------------------------------------------------------------------------------|-------------------------------|----------|---------|-------|------------|
| properties | base MessageBody | | | | | |
| children | D2001_SPID D3001_MeterId D3004_NrDigits MeterLocation D3003_PhysicalMeterSize D3002_ChargeableMeterSize D3005_SewerageChargeableMeterSize D3011_MeterReadFrequency D3007_ReturnToSewerAllowance D3013_MeterMake D3014_ManufacturerMeterSerialNr D2010_YVe D3015_datalogger_SW D3016_datalogger_NonSW D3017_GISX D3018_GISY D3019_GISZFreeDescriptor D3022_MeterTreatment D3025_MeterLocationCode | | | | | |
| used by | element ResponseMessagesType/T004.1_NewMeterNotification | | | | | |
| attributes | Name | Type | Use | Default | Fixed | annotation |
| | MID | MessageIdType | required | | | |
| | RelatedMID | MessageIdType | optional | | | |
| annotation | documentation | | | | | |
| source | <pre> <xs:complexType name="T004.1_NewMeterNotificationType"> <xs:annotation> <xs:documentation> </xs:documentation> </xs:annotation> <xs:complexContent> <xs:extension base="MessageBody"> <xs:sequence> <xs:element ref="D2001_SPID" minOccurs="0"/> <xs:element ref="D3001_MeterId"/> <xs:element ref="D3004_NrDigits"/> <xs:element name="MeterLocation" type="AddressType"/> <xs:element ref="D3003_PhysicalMeterSize" minOccurs="0"/> <xs:element ref="D3002_ChargeableMeterSize"/> <xs:element ref="D3005_SewerageChargeableMeterSize"/> <xs:element ref="D3011_MeterReadFrequency"/> <xs:element ref="D3007_ReturnToSewerAllowance"/> <xs:element ref="D3013_MeterMake"/> <xs:element ref="D3014_ManufacturerMeterSerialNr"/> <xs:element ref="D2010_YVe" minOccurs="0"/> <xs:element ref="D3015_datalogger_SW" minOccurs="0"/> <xs:element ref="D3016_datalogger_NonSW" minOccurs="0"/> <xs:element ref="D3017_GISX" minOccurs="0"/> <xs:element ref="D3018_GISY" minOccurs="0"/> <xs:element ref="D3019_GISZFreeDescriptor" minOccurs="0"/> <xs:element ref="D3022_MeterTreatment"/> <xs:element ref="D3025_MeterLocationCode" minOccurs="0"/> </xs:sequence> </xs:extension> </xs:complexContent> </xs:complexType> </pre> | | | | | |

element **T004.1_NewMeterNotificationType/MeterLocation**

| | |
|-------------------|--------------------------------------------------------------------------------------------------------------------------------------------------------------------------------------------------------------------------------------------------------------------------------------------------------------------------------------------------------------------------------------------------------------------------------------------------------------------------------------------------------------------------------------|
| <p>diagram</p> | |
| <p>namespace</p> | <p>urn:bridgeall-com:cmaservice:data:v3</p> |
| <p>type</p> | <p>AddressType</p> |
| <p>properties</p> | <p>isRef 0 content complex</p> |
| <p>children</p> | <p>D5001_FreeDescriptor D5002_SubBuildingName D5003_BuildingName D5004_BuildingNumber D5005_DependentThoroughfareName D5006_DependentThoroughfareDescriptor D5007_ThoroughfareName D5008_ThoroughfareDescriptor D5009_DoubleDependentLocality D5010_DependentLocality D5011_PostTown D5012_County D5013_Postcode</p> |
| <p>source</p> | <p><xs:element name="MeterLocation" type="AddressType"/></p> |

complexType **T004.3_VirtualMeterType**

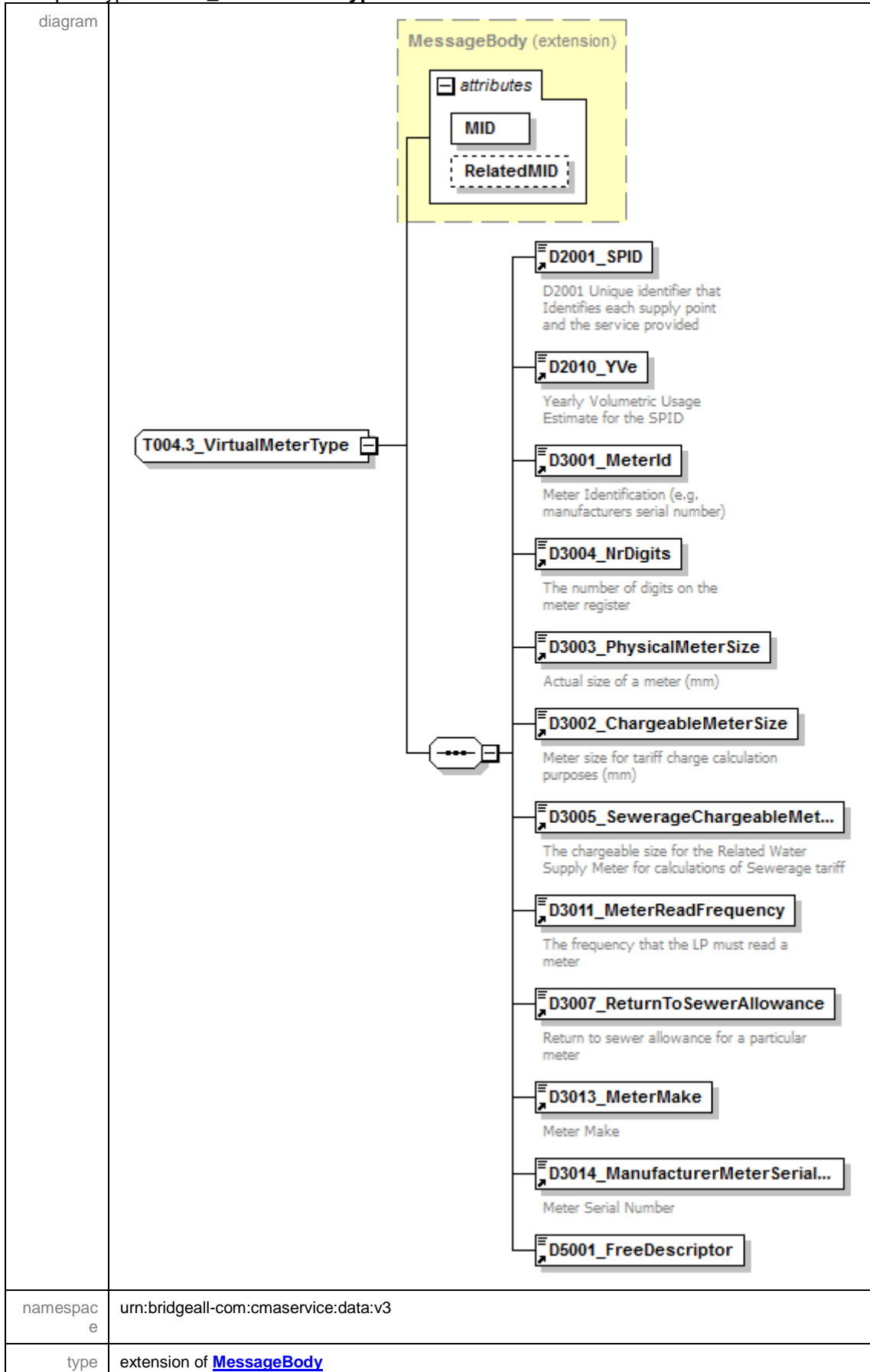

| properties | base MessageBody | | | | | | | | | | | | | | | | | | |
|----------------------------|-------------------------------------------------------------------------------------------------------------------------------------------------------------------------------------------------------------------------------------------------------------------------------------------------------------------------------------------------------------------------------------------------------------------------------------------------------------------------------------------------------------------------------------------------------------------------------------------------------------------------------------------------------------------------------------------------------------------------------------------------------------------------------------------------------------------------------------------------------------------------------------------------------------------------------------------------------------------------------------------------------------------------------------------------------------------------------------------------------------------------------|----------|---------|-------|------------|-------|------------|---------------------|-------------------------------|----------|--|--|--|----------------------------|-------------------------------|----------|--|--|--|
| children | D2001_SPID D2010_YVe D3001_MeterId D3004_NrDigits D3003_PhysicalMeterSize D3002_ChargeableMeterSize D3005_SewerageChargeableMeterSize D3011_MeterReadFrequency D3007_ReturnToSewerAllowance D3013_MeterMake D3014_ManufacturerMeterSerialNr D5001_FreeDescriptor | | | | | | | | | | | | | | | | | | |
| used by | element MessagesType/T004.3_VirtualMeters/T004.3_VirtualMeter | | | | | | | | | | | | | | | | | | |
| attributes | <table border="1"> <thead> <tr> <th>Name</th> <th>Type</th> <th>Use</th> <th>Default</th> <th>Fixed</th> <th>annotation</th> </tr> </thead> <tbody> <tr> <td>MID</td> <td>MessageldType</td> <td>required</td> <td></td> <td></td> <td></td> </tr> <tr> <td>RelatedMID</td> <td>MessageldType</td> <td>optional</td> <td></td> <td></td> <td></td> </tr> </tbody> </table> | Name | Type | Use | Default | Fixed | annotation | MID | MessageldType | required | | | | RelatedMID | MessageldType | optional | | | |
| Name | Type | Use | Default | Fixed | annotation | | | | | | | | | | | | | | |
| MID | MessageldType | required | | | | | | | | | | | | | | | | | |
| RelatedMID | MessageldType | optional | | | | | | | | | | | | | | | | | |
| annotation | documentation | | | | | | | | | | | | | | | | | | |
| source | <pre> <xs:complexType name="T004.3_VirtualMeterType"> <xs:annotation> <xs:documentation> </xs:documentation> </xs:annotation> <xs:complexContent> <xs:extension base="MessageBody"> <xs:sequence> <xs:element ref="D2001_SPID"/> <xs:element ref="D2010_YVe"/> <xs:element ref="D3001_MeterId"/> <xs:element ref="D3004_NrDigits"/> <xs:element ref="D3003_PhysicalMeterSize"/> <xs:element ref="D3002_ChargeableMeterSize"/> <xs:element ref="D3005_SewerageChargeableMeterSize"/> <xs:element ref="D3011_MeterReadFrequency"/> <xs:element ref="D3007_ReturnToSewerAllowance"/> <xs:element ref="D3013_MeterMake"/> <xs:element ref="D3014_ManufacturerMeterSerialNr"/> <xs:element ref="D5001_FreeDescriptor"/> </xs:sequence> </xs:extension> </xs:complexContent> </xs:complexType> </pre> | | | | | | | | | | | | | | | | | | |

complexType **T006.0_LPWaterSPIDUpdateType**

| <p>diagram</p> | <p>The diagram illustrates the structure of the T006.0_LPWaterSPIDUpdateType complex type. It is an extension of the MessageBody type. The MessageBody (extension) contains two attributes: MID and RelatedMID. The T006.0_LPWaterSPIDUpdateType contains a sequence of four elements: D2001_SPID, D2005_CustomerClassification, D2008_SICCode, and D2011_RateableValue. The elements D2005_CustomerClassification, D2008_SICCode, and D2011_RateableValue are optional, indicated by a dashed box and minOccurs="0".</p> <ul style="list-style-type: none"> D2001_SPID: D2001 Unique identifier that Identifies each supply point and the service provided D2005_CustomerClassification: Customer classification for a SPID (e.g. Large Impact, Sensitive) D2008_SICCode: SIC Code applicable to a SPID D2011_RateableValue: Rateable Value of Supply Point | | | | | | | | | | | | | | | | | | |
|----------------------------|--------------------------------------------------------------------------------------------------------------------------------------------------------------------------------------------------------------------------------------------------------------------------------------------------------------------------------------------------------------------------------------------------------------------------------------------------------------------------------------------------------------------------------------------------------------------------------------------------------------------------------------------------------------------------------------------------------------------------------------------------------------------------------------------------------------------------------------------------------------------------------------------------------------------------------------------------------------------------------------------------------------------------------------|----------|---------|-------|------------|-------|------------|---------------------|-------------------------------|----------|--|--|--|----------------------------|-------------------------------|----------|--|--|--|
| <p>namespace</p> | <p>urn:bridgeall-com:cmaservice:data:v3</p> | | | | | | | | | | | | | | | | | | |
| <p>type</p> | <p>extension of MessageBody</p> | | | | | | | | | | | | | | | | | | |
| <p>properties</p> | <p>base MessageBody</p> | | | | | | | | | | | | | | | | | | |
| <p>children</p> | <p>D2001_SPID D2005_CustomerClassification D2008_SICCode D2011_RateableValue</p> | | | | | | | | | | | | | | | | | | |
| <p>used by</p> | <p>element MessagesType/T006.0_LPWaterSPIDUpdates/T006.0_LPWaterSPIDUpdate</p> | | | | | | | | | | | | | | | | | | |
| <p>attributes</p> | <table border="1"> <thead> <tr> <th>Name</th> <th>Type</th> <th>Use</th> <th>Default</th> <th>Fixed</th> <th>annotation</th> </tr> </thead> <tbody> <tr> <td>MID</td> <td>MessageIdType</td> <td>required</td> <td></td> <td></td> <td></td> </tr> <tr> <td>RelatedMID</td> <td>MessageIdType</td> <td>optional</td> <td></td> <td></td> <td></td> </tr> </tbody> </table> | Name | Type | Use | Default | Fixed | annotation | MID | MessageIdType | required | | | | RelatedMID | MessageIdType | optional | | | |
| Name | Type | Use | Default | Fixed | annotation | | | | | | | | | | | | | | |
| MID | MessageIdType | required | | | | | | | | | | | | | | | | | |
| RelatedMID | MessageIdType | optional | | | | | | | | | | | | | | | | | |
| <p>annotation</p> | <p>documentation</p> | | | | | | | | | | | | | | | | | | |
| <p>source</p> | <pre><xs:complexType name="T006.0_LPWaterSPIDUpdateType"> <xs:annotation> <xs:documentation> </xs:documentation> </xs:annotation> <xs:complexContent> <xs:extension base="MessageBody"> <xs:sequence> <xs:element ref="D2001_SPID"/> <xs:element ref="D2005_CustomerClassification" minOccurs="0"/> <xs:element ref="D2008_SICCode" minOccurs="0"/> <xs:element ref="D2011_RateableValue" minOccurs="0"/> </xs:sequence> </xs:extension> </xs:complexContent> </xs:complexType></pre> | | | | | | | | | | | | | | | | | | |

complexType **T006.1_LPsewerageSPIDUpdateType**

| diagram | | | | | | | | | | | | | | | | | | | |
|----------------------------|------------------------------------------------------------------------------------------------------------------------------------------------------------------------------------------------------------------------------------------------------------------------------------------------------------------------------------------------------------------------------------------------------------------------------------------------------------------------------------------------------------------------------------------------------------------------------------------------------------------------------------------------------------------------------------------|----------|---------|-------|------------|-------|------------|---------------------|-------------------------------|----------|--|--|--|----------------------------|-------------------------------|----------|--|--|--|
| namespace | urn:bridgeall-com:cmaservice:data:v3 | | | | | | | | | | | | | | | | | | |
| type | extension of MessageBody | | | | | | | | | | | | | | | | | | |
| properties | base MessageBody | | | | | | | | | | | | | | | | | | |
| children | D2001_SPID D2005_CustomerClassification D2008_SICCode D2011_RateableValue | | | | | | | | | | | | | | | | | | |
| used by | element MessagesType/T006.1_LPsewerageSPIDUpdates/T006.1_LPsewerageSPIDUpdate | | | | | | | | | | | | | | | | | | |
| attributes | <table border="1"> <thead> <tr> <th>Name</th> <th>Type</th> <th>Use</th> <th>Default</th> <th>Fixed</th> <th>annotation</th> </tr> </thead> <tbody> <tr> <td>MID</td> <td>MessageIdType</td> <td>required</td> <td></td> <td></td> <td></td> </tr> <tr> <td>RelatedMID</td> <td>MessageIdType</td> <td>optional</td> <td></td> <td></td> <td></td> </tr> </tbody> </table> | Name | Type | Use | Default | Fixed | annotation | MID | MessageIdType | required | | | | RelatedMID | MessageIdType | optional | | | |
| Name | Type | Use | Default | Fixed | annotation | | | | | | | | | | | | | | |
| MID | MessageIdType | required | | | | | | | | | | | | | | | | | |
| RelatedMID | MessageIdType | optional | | | | | | | | | | | | | | | | | |
| annotation | documentation | | | | | | | | | | | | | | | | | | |
| source | <pre> <xs:complexType name="T006.1_LPsewerageSPIDUpdateType"> <xs:annotation> <xs:documentation> </xs:documentation> </xs:annotation> <xs:complexContent> <xs:extension base="MessageBody"> <xs:sequence> <xs:element ref="D2001_SPID"/> <xs:element ref="D2005_CustomerClassification" minOccurs="0"/> <xs:element ref="D2008_SICCode" minOccurs="0"/> <xs:element ref="D2011_RateableValue" minOccurs="0"/> </xs:sequence> </xs:extension> </xs:complexContent> </xs:complexType> </pre> | | | | | | | | | | | | | | | | | | |

complexType **T006.2_WaterSPIDUpdateType**

| | | | | | | | |
|------------|-------------------------------------------------------------------------------------------------------------------------------------------------------------------------------------------------------------------------------------------------------------------------------------------------------------------------------------------------------------------------------------------------------------------------------------------------------------------------------------------------------------------------------------------------------------------------------------------------------------------------------------------------------------------------------------------------|-------------------------------|----------|---------|-------|------------|--|
| diagram | <p>The diagram shows the structure of the T006.2_WaterSPIDUpdateType complex type. It is an extension of the MessageBody type. The MessageBody (extension) contains an attributes container with two elements: MID (required) and RelatedMID (optional). The T006.2_WaterSPIDUpdateType contains a sequence of four elements: D2001_SPID (required), D2018_TroughsDrinkingBowls (required), D2020_OutsideTaps (required), and D2014_FarmCroft (required). The D2014_FarmCroft element has a note: "If Outside Taps or Troughs and Drinking Bowls are True, this must be used to specify farm or croft."</p> | | | | | | |
| namespace | urn:bridgeall-com:cmaservice:data:v3 | | | | | | |
| type | extension of MessageBody | | | | | | |
| properties | base MessageBody | | | | | | |
| children | D2001_SPID D2018_TroughsDrinkingBowls D2020_OutsideTaps D2014_FarmCroft | | | | | | |
| used by | element MessagesType/T006.2_WaterSPIDUpdates/T006.2_WaterSPIDUpdate | | | | | | |
| attributes | Name | Type | Use | Default | Fixed | annotation | |
| | MID | MessageIdType | required | | | | |
| | RelatedMID | MessageIdType | optional | | | | |
| annotation | documentation | | | | | | |
| source | <pre> <xs:complexType name="T006.2_WaterSPIDUpdateType"> <xs:annotation> <xs:documentation> </xs:documentation> </xs:annotation> <xs:complexContent> <xs:extension base="MessageBody"> <xs:sequence> <xs:element ref="D2001_SPID"/> <xs:element ref="D2018_TroughsDrinkingBowls"/> <xs:element ref="D2020_OutsideTaps"/> <xs:element ref="D2014_FarmCroft"/> </xs:sequence> </xs:extension> </xs:complexContent> </xs:complexType> </pre> | | | | | | |

```

</xs:sequence>
</xs:extension>
</xs:complexContent>
</xs:complexType>

```

complexType T006.3_SewerageSPIDUpdateType

| diagram | | | | | | | | | | | | | | | | | | | |
|----------------------------|-------------------------------------------------------------------------------------------------------------------------------------------------------------------------------------------------------------------------------------------------------------------------------------------------------------------------------------------------------------------------------------------------------------------------------------------------------------------------------------------------------------------------------------------------------------------------------------|----------|---------|-------|------------|-------|------------|---------------------|-------------------------------|----------|--|--|--|----------------------------|-------------------------------|----------|--|--|--|
| namespace | urn:bridgeall-com:cmaservice:data:v3 | | | | | | | | | | | | | | | | | | |
| type | extension of MessageBody | | | | | | | | | | | | | | | | | | |
| properties | base MessageBody | | | | | | | | | | | | | | | | | | |
| children | D2001_SPID D2016_PropertyDrainage D2017_RoadDrainage | | | | | | | | | | | | | | | | | | |
| used by | element MessagesType/T006.3_SewerageSPIDUpdates/T006.3_SewerageSPIDUpdate | | | | | | | | | | | | | | | | | | |
| attributes | <table border="1"> <thead> <tr> <th>Name</th> <th>Type</th> <th>Use</th> <th>Default</th> <th>Fixed</th> <th>annotation</th> </tr> </thead> <tbody> <tr> <td>MID</td> <td>MessageIdType</td> <td>required</td> <td></td> <td></td> <td></td> </tr> <tr> <td>RelatedMID</td> <td>MessageIdType</td> <td>optional</td> <td></td> <td></td> <td></td> </tr> </tbody> </table> | Name | Type | Use | Default | Fixed | annotation | MID | MessageIdType | required | | | | RelatedMID | MessageIdType | optional | | | |
| Name | Type | Use | Default | Fixed | annotation | | | | | | | | | | | | | | |
| MID | MessageIdType | required | | | | | | | | | | | | | | | | | |
| RelatedMID | MessageIdType | optional | | | | | | | | | | | | | | | | | |
| annotation | documentation | | | | | | | | | | | | | | | | | | |
| source | <pre> <xs:complexType name="T006.3_SewerageSPIDUpdateType"> <xs:annotation> <xs:documentation> </xs:documentation> </xs:annotation> <xs:complexContent> <xs:extension base="MessageBody"> <xs:sequence> <xs:element ref="D2001_SPID"/> <xs:element ref="D2016_PropertyDrainage"/> <xs:element ref="D2017_RoadDrainage"/> </xs:sequence> </xs:extension> </xs:complexContent> </xs:complexType> </pre> | | | | | | | | | | | | | | | | | | |

</xs:complexType>

complexType T006.4_WaterSPIDNotificationType

| | | | | | | |
|------------|-------------------------------------------------------------------------------------------------------------------------------------------------------------------------------------------------------------------------|-------------------------------|----------|---------|-------|------------|
| diagram | | | | | | |
| namespace | urn:bridgeall-com:cmaservice:data:v3 | | | | | |
| type | extension of MessageBody | | | | | |
| properties | base MessageBody | | | | | |
| children | D2001_SPID D2018_TroughsDrinkingBowls D2020_OutsideTaps D2011_RateableValue D2014_FarmCroft | | | | | |
| used by | element ResponseMessagesType/T006.4_WaterSPIDNotification | | | | | |
| attributes | Name | Type | Use | Default | Fixed | annotation |
| | MID | MessageIdType | required | | | |
| | RelatedMID | MessageIdType | optional | | | |
| annotation | documentation | | | | | |
| source | <pre><xs:complexType name="T006.4_WaterSPIDNotificationType"> <xs:annotation> <xs:documentation> </xs:documentation> </xs:annotation> <xs:complexContent></pre> | | | | | |

```

<xs:extension base="MessageBody">
  <xs:sequence>
    <xs:element ref="D2001_SPID"/>
    <xs:element ref="D2018_TroughsDrinkingBowls"/>
    <xs:element ref="D2020_OutsideTaps"/>
    <xs:element ref="D2011_RateableValue"/>
    <xs:element ref="D2014_FarmCroft"/>
  </xs:sequence>
</xs:extension>
</xs:complexContent>
</xs:complexType>

```

complexType **T006.5_SewerageSPIDNotificationType**

| diagram | | | | | | | | | | | | | | | | | | | |
|----------------------------|--------------------------------------------------------------------------------------------------------------------------------------------------------------------------------------------------------------------------------------------------------------------------------------------------------------------------------------------------------------------------------------------------------------------------------------------|----------|---------|-------|------------|-------|------------|---------------------|-------------------------------|----------|--|--|--|----------------------------|-------------------------------|----------|--|--|--|
| namespace | urn:bridgeall-com:cmaservice:data:v3 | | | | | | | | | | | | | | | | | | |
| type | extension of MessageBody | | | | | | | | | | | | | | | | | | |
| properties | base MessageBody | | | | | | | | | | | | | | | | | | |
| children | D2001_SPID D2016_PropertyDrainage D2017_RoadDrainage D2011_RateableValue | | | | | | | | | | | | | | | | | | |
| used by | element ResponseMessagesType/T006.5_SewerageSPIDNotification | | | | | | | | | | | | | | | | | | |
| attributes | <table border="1"> <thead> <tr> <th>Name</th> <th>Type</th> <th>Use</th> <th>Default</th> <th>Fixed</th> <th>annotation</th> </tr> </thead> <tbody> <tr> <td>MID</td> <td>MessageIdType</td> <td>required</td> <td></td> <td></td> <td></td> </tr> <tr> <td>RelatedMID</td> <td>MessageIdType</td> <td>optional</td> <td></td> <td></td> <td></td> </tr> </tbody> </table> | Name | Type | Use | Default | Fixed | annotation | MID | MessageIdType | required | | | | RelatedMID | MessageIdType | optional | | | |
| Name | Type | Use | Default | Fixed | annotation | | | | | | | | | | | | | | |
| MID | MessageIdType | required | | | | | | | | | | | | | | | | | |
| RelatedMID | MessageIdType | optional | | | | | | | | | | | | | | | | | |
| annotation | documentation | | | | | | | | | | | | | | | | | | |
| source | <pre> <xs:complexType name="T006.5_SewerageSPIDNotificationType"> <xs:annotation> <xs:documentation> </pre> | | | | | | | | | | | | | | | | | | |

```

</xs:documentation>
</xs:annotation>
<xs:complexContent>
  <xs:extension base="MessageBody">
    <xs:sequence>
      <xs:element ref="D2001_SPID"/>
      <xs:element ref="D2016_PropertyDrainage"/>
      <xs:element ref="D2017_RoadDrainage"/>
      <xs:element ref="D2011_RateableValue"/>
    </xs:sequence>
  </xs:extension>
</xs:complexContent>
</xs:complexType>

```

complexType T006.6_ProvideLiveRateableValueType

| | | | | | | |
|------------|-----------------------------------------------------------------------------------------------------------------------------------------------------------------------------------------------------------------------------------------------------------------------------------------------------------------------------------------------|-------------------------------|----------|---------|-------|------------|
| diagram | | | | | | |
| namespace | urn:bridgeall-com:cmaservice:data:v3 | | | | | |
| type | extension of MessageBody | | | | | |
| properties | base MessageBody | | | | | |
| children | D2001_SPID D2042_LiveRateableValue | | | | | |
| used by | element MessagesType/T006.6_ProvideLiveRateableValues/T006.6_ProvideLiveRateableValue | | | | | |
| attributes | Name | Type | Use | Default | Fixed | annotation |
| | MID | MessageIdType | required | | | |
| | RelatedMID | MessageIdType | optional | | | |
| annotation | documentation | | | | | |
| source | <pre> <xs:complexType name="T006.6_ProvideLiveRateableValueType"> <xs:annotation> <xs:documentation> </xs:documentation> </xs:annotation> <xs:complexContent> <xs:extension base="MessageBody"> <xs:sequence> <xs:element ref="D2001_SPID"/> </pre> | | | | | |

```

<xs:element ref="D2042_LiveRateableValue"/>
</xs:sequence>
</xs:extension>
</xs:complexContent>
</xs:complexType>

```

complexType T006.7_ProvideLiveRateableValueNotificationType

| | | | | | | |
|------------|-------------------------------------------------------------------------------------------------------------------------------------------------------------------------------------------------------------------------------------------------------------------------------------------------------------------------------------------------------------------------------------------------------------------------------------------------------------------------------------------------------------------------------------------------|-------------------------------|----------|---------|-------|------------|
| diagram | | | | | | |
| namespace | urn:bridgeall-com:cmaservice:data:v3 | | | | | |
| type | extension of MessageBody | | | | | |
| properties | base MessageBody | | | | | |
| children | D2001_SPID D2042_LiveRateableValue | | | | | |
| used by | element ResponseMessagesType/T006.7_ProvideLiveRateableValueNotification | | | | | |
| attributes | Name | Type | Use | Default | Fixed | annotation |
| | MID | MessageIdType | required | | | |
| | RelatedMID | MessageIdType | optional | | | |
| annotation | documentation | | | | | |
| source | <pre> <xs:complexType name="T006.7_ProvideLiveRateableValueNotificationType"> <xs:annotation> <xs:documentation> </xs:documentation> </xs:annotation> <xs:complexContent> <xs:extension base="MessageBody"> <xs:sequence> <xs:element ref="D2001_SPID"/> <xs:element ref="D2042_LiveRateableValue"/> </xs:sequence> </xs:extension> </xs:complexContent> </xs:complexType> </pre> | | | | | |

complexType **T007.0_WaterConnectionCompleteType**

| <p>diagram</p> | | | | | | | | | | | | | | | | | | | |
|----------------------------|---------------------------------------------------------------------------------------------------------------------------------------------------------------------------------------------------------------------------------------------------------------------------------------------------------------------------------------------------------------------------------------------------------------------------------------------------------------------------------------------------------------------------------------------------------------------------------------------------------------|----------|---------|-------|------------|-------|------------|---------------------|-------------------------------|----------|--|--|--|----------------------------|-------------------------------|----------|--|--|--|
| <p>namespace</p> | <p>urn:bridgeall-com:cmaservice:data:v3</p> | | | | | | | | | | | | | | | | | | |
| <p>type</p> | <p>extension of MessageBody</p> | | | | | | | | | | | | | | | | | | |
| <p>properties</p> | <p>base MessageBody</p> | | | | | | | | | | | | | | | | | | |
| <p>children</p> | <p>D2001_SPID D2013_ConnectionDate D2033_AccreditedEntityInstall</p> | | | | | | | | | | | | | | | | | | |
| <p>used by</p> | <p>element MessagesType/T007.0_WaterConnectionCompletes/T007.0_WaterConnectionComplete</p> | | | | | | | | | | | | | | | | | | |
| <p>attributes</p> | <table border="1"> <thead> <tr> <th>Name</th> <th>Type</th> <th>Use</th> <th>Default</th> <th>Fixed</th> <th>annotation</th> </tr> </thead> <tbody> <tr> <td>MID</td> <td>MessageIdType</td> <td>required</td> <td></td> <td></td> <td></td> </tr> <tr> <td>RelatedMID</td> <td>MessageIdType</td> <td>optional</td> <td></td> <td></td> <td></td> </tr> </tbody> </table> | Name | Type | Use | Default | Fixed | annotation | MID | MessageIdType | required | | | | RelatedMID | MessageIdType | optional | | | |
| Name | Type | Use | Default | Fixed | annotation | | | | | | | | | | | | | | |
| MID | MessageIdType | required | | | | | | | | | | | | | | | | | |
| RelatedMID | MessageIdType | optional | | | | | | | | | | | | | | | | | |
| <p>annotation</p> | <p>documentation</p> | | | | | | | | | | | | | | | | | | |
| <p>source</p> | <pre><xs:complexType name="T007.0_WaterConnectionCompleteType"> <xs:annotation> <xs:documentation> </xs:documentation> </xs:annotation> <xs:complexContent> <xs:extension base="MessageBody"> <xs:sequence> <xs:element ref="D2001_SPID"/> <xs:element ref="D2013_ConnectionDate"/> <xs:element ref="D2033_AccreditedEntityInstall" minOccurs="0"/> </xs:sequence> </xs:extension> </xs:complexContent> </xs:complexType></pre> | | | | | | | | | | | | | | | | | | |

complexType **T009.4_NotificationType**

| diagram | | | | | | | | | | | | | | | | | | | |
|----------------------------|--------------------------------------------------------------------------------------------------------------------------------------------------------------------------------------------------------------------------------------------------------------------------------------------------------------------------------------------------------------------------------------------------------------------------------------------------------------------------------------------------------------------------------|----------|---------|-------|------------|-------|------------|---------------------|-------------------------------|----------|--|--|--|----------------------------|-------------------------------|----------|--|--|--|
| namespace | urn:bridgeall-com:cmaservice:data:v3 | | | | | | | | | | | | | | | | | | |
| type | extension of MessageBody | | | | | | | | | | | | | | | | | | |
| properties | base MessageBody | | | | | | | | | | | | | | | | | | |
| children | D1009_DuplicateMessageID D4004_ReturnCode | | | | | | | | | | | | | | | | | | |
| used by | element ResponseMessagesType/T009.4_Notification | | | | | | | | | | | | | | | | | | |
| attributes | <table border="1"> <thead> <tr> <th>Name</th> <th>Type</th> <th>Use</th> <th>Default</th> <th>Fixed</th> <th>annotation</th> </tr> </thead> <tbody> <tr> <td>MID</td> <td>MessageIdType</td> <td>required</td> <td></td> <td></td> <td></td> </tr> <tr> <td>RelatedMID</td> <td>MessageIdType</td> <td>optional</td> <td></td> <td></td> <td></td> </tr> </tbody> </table> | Name | Type | Use | Default | Fixed | annotation | MID | MessageIdType | required | | | | RelatedMID | MessageIdType | optional | | | |
| Name | Type | Use | Default | Fixed | annotation | | | | | | | | | | | | | | |
| MID | MessageIdType | required | | | | | | | | | | | | | | | | | |
| RelatedMID | MessageIdType | optional | | | | | | | | | | | | | | | | | |
| annotation | documentation | | | | | | | | | | | | | | | | | | |
| source | <pre> <xs:complexType name="T009.4_NotificationType"> <xs:annotation> <xs:documentation> </xs:documentation> </xs:annotation> <xs:complexContent> <xs:extension base="MessageBody"> <xs:sequence> <xs:element ref="D1009_DuplicateMessageID"/> <xs:element ref="D4004_ReturnCode"/> </xs:sequence> </xs:extension> </xs:complexContent> </xs:complexType> </pre> | | | | | | | | | | | | | | | | | | |

complexType **T012.0_MiscSPIDUpdateType**

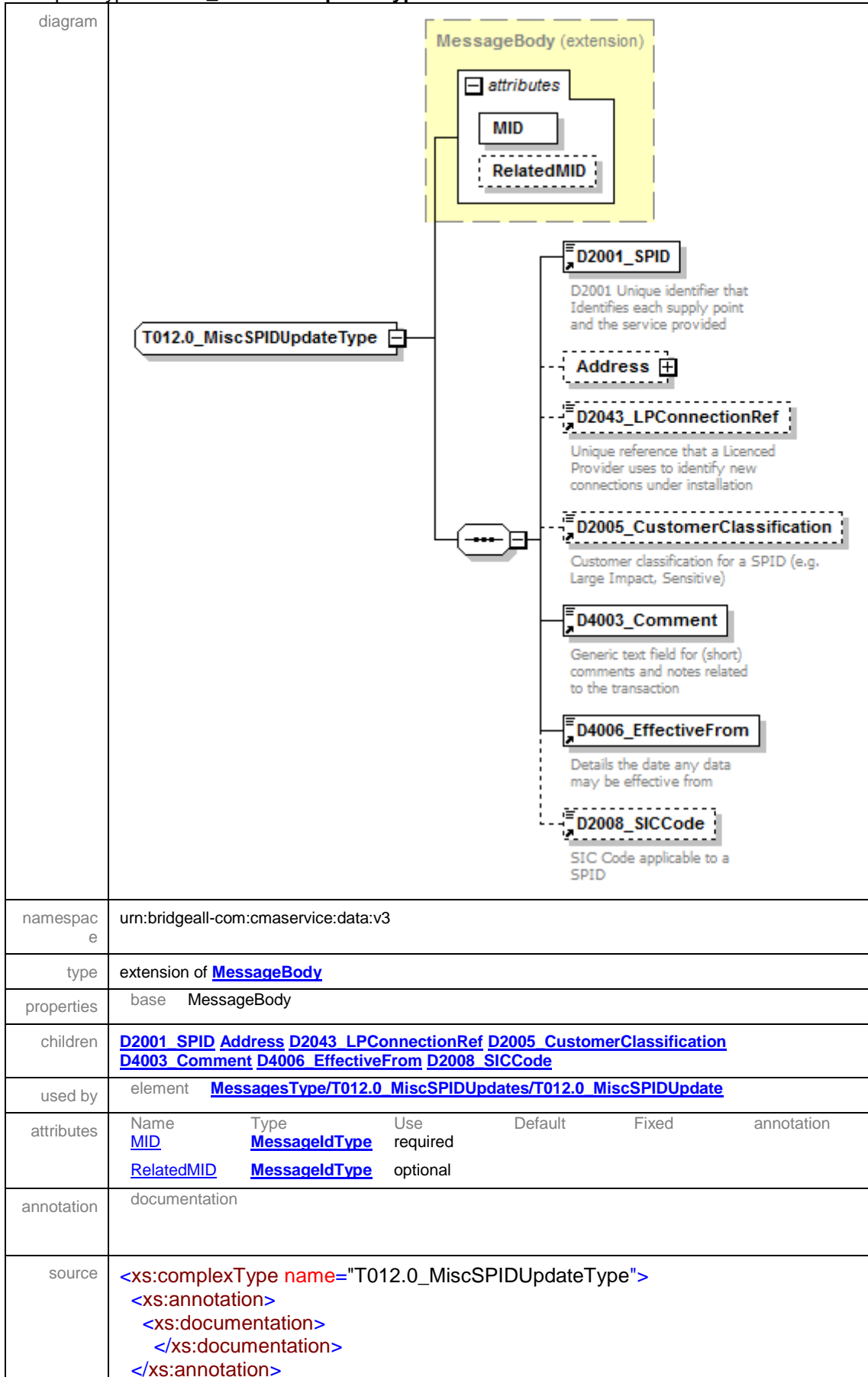

```

<xs:complexContent>
  <xs:extension base="MessageBody">
    <xs:sequence>
      <xs:element ref="D2001_SPID"/>
      <xs:element name="Address" type="AddressType" minOccurs="0"/>
      <xs:element ref="D2043_LPConnectionRef" minOccurs="0"/>
      <xs:element ref="D2005_CustomerClassification" minOccurs="0"/>
      <xs:element ref="D4003_Comment"/>
      <xs:element ref="D4006_EffectiveFrom"/>
      <xs:element ref="D2008_SICCode" minOccurs="0"/>
    </xs:sequence>
  </xs:extension>
</xs:complexContent>
</xs:complexType>

```

element **T012.0_MiscSPIDUpdateType/Address**

| | |
|------------|-------------------------------------------------------------------------------------------------------------------------------------------------------------------------------------------------------------------------------------------------------------------------------------------------------------------------------------------------------------------------------------------------------------------------------------------------------------------------------------------------------------------------------------|
| diagram | |
| namespace | urn:bridgeall-com:cmaservice:data:v3 |
| type | AddressType |
| properties | isRef 0 minOcc 0 maxOcc 1 content complex |
| children | D5001_FreeDescriptor D5002_SubBuildingName D5003_BuildingName D5004_BuildingNumber D5005_DependentThoroughfareDescriptor D5006_DependentThoroughfareDescriptor D5007_ThoroughfareName D5008_ThoroughfareDescriptor D5009_DoubleDependentLocality D5010_DependentLocality D5011_PostTown D5012_County D5013_Postcode |

| | |
|--------|---------------------------------------------------------------|
| source | <xs:element name="Address" type="AddressType" minOccurs="0"/> |
|--------|---------------------------------------------------------------|

complexType **T012.1_ServiceElementUpdateType**

| | |
|------------|--------------------------------------------------------------------------------------------------------------------------------------------------------------------------------------------------------------------------------------------------------------------------------------------------------------------------------------------------------------------------------------------------------------------------------------------------------------------------------------------------------------------------------------------------------------------------------------------------------------------------------------------------------------------------------------------------------------------------------------------------------------------------------------------------------------------------------------------------------------------------------------------------------------------------------------------------------------------------------------------------------------------------------------------------------------------------------------------------------------------------------------------------------------------|
| diagram | <p>The diagram shows the structure of the T012.1_ServiceElementUpdateType complex type. It is an extension of MessageBody. The MessageBody extension contains an attributes container with MID and RelatedMID. The T012.1_ServiceElementUpdateType contains the following elements:</p> <ul style="list-style-type: none"> D2001_SPID: D2001 Unique identifier that Identifies each supply point and the service provided D2018_TroughsDrinkingBowls: Does SPID have this Service Element (how many) D2020_OutsideTaps: Does SPID have this Service Element (how many) D2011_RateableValue: Rateable Value of Supply Point D2015_SPIDVacant: Declares premises for the SPID as vacant D2014_FarmCroft: If Outside Taps or Troughs and Drinking Bowls are True, this must be used to specify farm or croft. D4006_EffectiveFrom: Details the date any data may be effective from D4003_Comment: Generic text field for (short) comments and notes related to the transaction |
| namespace | urn:bridgeall-com:cmaservice:data:v3 |
| type | extension of MessageBody |
| properties | base MessageBody |
| children | D2001_SPID D2018_TroughsDrinkingBowls D2020_OutsideTaps D2011_RateableValue D2015_SPIDVacant D2014_FarmCroft D4006_EffectiveFrom D4003_Comment |
| used by | element MessagesType/T012.1_ServiceElementUpdates/T012.1_ServiceElementUpdate |

| attributes | <table border="1"> <thead> <tr> <th data-bbox="357 192 539 219">Name</th> <th data-bbox="539 192 730 219">Type</th> <th data-bbox="730 192 890 219">Use</th> <th data-bbox="890 192 1034 219">Default</th> <th data-bbox="1034 192 1161 219">Fixed</th> <th data-bbox="1161 192 1361 219">annotation</th> </tr> </thead> <tbody> <tr> <td data-bbox="357 219 539 246">MID</td> <td data-bbox="539 219 730 246">MessageIdType</td> <td data-bbox="730 219 890 246">required</td> <td data-bbox="890 219 1034 246"></td> <td data-bbox="1034 219 1161 246"></td> <td data-bbox="1161 219 1361 246"></td> </tr> <tr> <td data-bbox="357 246 539 286">RelatedMID</td> <td data-bbox="539 246 730 286">MessageIdType</td> <td data-bbox="730 246 890 286">optional</td> <td data-bbox="890 246 1034 286"></td> <td data-bbox="1034 246 1161 286"></td> <td data-bbox="1161 246 1361 286"></td> </tr> </tbody> </table> | Name | Type | Use | Default | Fixed | annotation | MID | MessageIdType | required | | | | RelatedMID | MessageIdType | optional | | | |
|----------------------------|-----------------------------------------------------------------------------------------------------------------------------------------------------------------------------------------------------------------------------------------------------------------------------------------------------------------------------------------------------------------------------------------------------------------------------------------------------------------------------------------------------------------------------------------------------------------------------------------------------------------------------------------------------------------------------------------------------------------------------------------------------------------------------------------------------------------------------------------------------------------------------------------------------------------------------------------------------------------------------------|----------|---------|-------|------------|-------|------------|---------------------|-------------------------------|----------|--|--|--|----------------------------|-------------------------------|----------|--|--|--|
| Name | Type | Use | Default | Fixed | annotation | | | | | | | | | | | | | | |
| MID | MessageIdType | required | | | | | | | | | | | | | | | | | |
| RelatedMID | MessageIdType | optional | | | | | | | | | | | | | | | | | |
| annotation | documentation | | | | | | | | | | | | | | | | | | |
| source | <pre> <xs:complexType name="T012.1_ServiceElementUpdateType"> <xs:annotation> <xs:documentation> </xs:documentation> </xs:annotation> <xs:complexContent> <xs:extension base="MessageBody"> <xs:sequence> <xs:element ref="D2001_SPID"/> <xs:element ref="D2018_TroughsDrinkingBowls" minOccurs="0"/> <xs:element ref="D2020_OutsideTaps" minOccurs="0"/> <xs:element ref="D2011_RateableValue" minOccurs="0"/> <xs:element ref="D2015_SPIDVacant" minOccurs="0"/> <xs:element ref="D2014_FarmCroft" minOccurs="0"/> <xs:element ref="D4006_EffectiveFrom"/> <xs:element ref="D4003_Comment"/> </xs:sequence> </xs:extension> </xs:complexContent> </xs:complexType> </pre> | | | | | | | | | | | | | | | | | | |

complexType **T012.3_SewerageServiceElementUpdateType**

| <p>diagram</p> | <p>The diagram illustrates the structure of the T012.3_SewerageServiceElementUpdateType complex type. It is an extension of the MessageBody type. The MessageBody (extension) contains an attributes container with two elements: MID (required) and RelatedMID (optional). The main complex type contains the following elements: D2001_SPID (required), D4006_EffectiveFrom (required), D2016_PropertyDrainage (optional), D2017_RoadDrainage (optional), and D4003_Comment (required). Each element is accompanied by a brief description of its purpose.</p> | | | | | | | | | | | | | | | | | | |
|----------------------------|-----------------------------------------------------------------------------------------------------------------------------------------------------------------------------------------------------------------------------------------------------------------------------------------------------------------------------------------------------------------------------------------------------------------------------------------------------------------------------------------------------------------------------------------------------------------------------------------------------------------------------------------------|----------|---------|-------|------------|-------|------------|---------------------|-------------------------------|----------|--|--|--|----------------------------|-------------------------------|----------|--|--|--|
| <p>namespace</p> | <p>urn:bridgeall-com:cmaservice:data:v3</p> | | | | | | | | | | | | | | | | | | |
| <p>type</p> | <p>extension of MessageBody</p> | | | | | | | | | | | | | | | | | | |
| <p>properties</p> | <p>base MessageBody</p> | | | | | | | | | | | | | | | | | | |
| <p>children</p> | <p>D2001_SPID D4006_EffectiveFrom D2016_PropertyDrainage D2017_RoadDrainage D4003_Comment</p> | | | | | | | | | | | | | | | | | | |
| <p>used by</p> | <p>element MessagesType/T012.3_SewerageServiceElementUpdates/T012.3_SewerageServiceElementUpdate</p> | | | | | | | | | | | | | | | | | | |
| <p>attributes</p> | <table border="1"> <thead> <tr> <th>Name</th> <th>Type</th> <th>Use</th> <th>Default</th> <th>Fixed</th> <th>annotation</th> </tr> </thead> <tbody> <tr> <td>MID</td> <td>MessageIdType</td> <td>required</td> <td></td> <td></td> <td></td> </tr> <tr> <td>RelatedMID</td> <td>MessageIdType</td> <td>optional</td> <td></td> <td></td> <td></td> </tr> </tbody> </table> | Name | Type | Use | Default | Fixed | annotation | MID | MessageIdType | required | | | | RelatedMID | MessageIdType | optional | | | |
| Name | Type | Use | Default | Fixed | annotation | | | | | | | | | | | | | | |
| MID | MessageIdType | required | | | | | | | | | | | | | | | | | |
| RelatedMID | MessageIdType | optional | | | | | | | | | | | | | | | | | |
| <p>annotation</p> | <p>documentation</p> | | | | | | | | | | | | | | | | | | |
| <p>source</p> | <pre><xs:complexType name="T012.3_SewerageServiceElementUpdateType"> <xs:annotation> <xs:documentation> </xs:documentation> </xs:annotation> <xs:complexContent> <xs:extension base="MessageBody"> <xs:sequence> <xs:element ref="D2001_SPID"/> <xs:element ref="D4006_EffectiveFrom"/> <xs:element ref="D2016_PropertyDrainage" minOccurs="0"/> </xs:sequence> </xs:extension> </xs:complexContent> </xs:complexType></pre> | | | | | | | | | | | | | | | | | | |

```

<xs:element ref="D2017_RoadDrainage" minOccurs="0"/>
<xs:element ref="D4003_Comment"/>
</xs:sequence>
</xs:extension>
</xs:complexContent>
</xs:complexType>

```

complexType **T012.7_UpdateLiveRateableValueType**

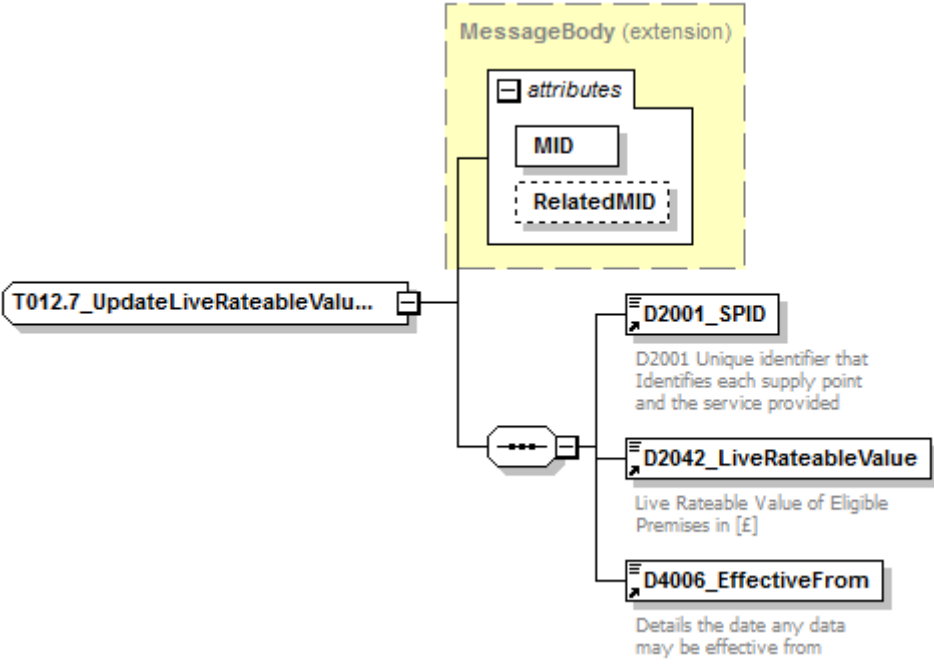
| diagram |  | | | | | | | | | | | | | | | | | | |
|----------------------------|--------------------------------------------------------------------------------------------------------------------------------------------------------------------------------------------------------------------------------------------------------------------------------------------------------------------------------------------------------------------------------------------------------------------------------------------------------------------------------------------------------------------------------------------------------------------------------------------|----------|---------|-------|------------|-------|------------|---------------------|-------------------------------|----------|--|--|--|----------------------------|-------------------------------|----------|--|--|--|
| namespace | urn:bridgeall-com:cmaservice:data:v3 | | | | | | | | | | | | | | | | | | |
| type | extension of MessageBody | | | | | | | | | | | | | | | | | | |
| properties | base MessageBody | | | | | | | | | | | | | | | | | | |
| children | D2001_SPID D2042_LiveRateableValue D4006_EffectiveFrom | | | | | | | | | | | | | | | | | | |
| used by | element MessagesType/T012.7_UpdateLiveRateableValues/T012.7_UpdateLiveRateableValue | | | | | | | | | | | | | | | | | | |
| attributes | <table border="1"> <thead> <tr> <th>Name</th> <th>Type</th> <th>Use</th> <th>Default</th> <th>Fixed</th> <th>annotation</th> </tr> </thead> <tbody> <tr> <td>MID</td> <td>MessageIdType</td> <td>required</td> <td></td> <td></td> <td></td> </tr> <tr> <td>RelatedMID</td> <td>MessageIdType</td> <td>optional</td> <td></td> <td></td> <td></td> </tr> </tbody> </table> | Name | Type | Use | Default | Fixed | annotation | MID | MessageIdType | required | | | | RelatedMID | MessageIdType | optional | | | |
| Name | Type | Use | Default | Fixed | annotation | | | | | | | | | | | | | | |
| MID | MessageIdType | required | | | | | | | | | | | | | | | | | |
| RelatedMID | MessageIdType | optional | | | | | | | | | | | | | | | | | |
| annotation | documentation | | | | | | | | | | | | | | | | | | |
| source | <pre> <xs:complexType name="T012.7_UpdateLiveRateableValueType"> <xs:annotation> <xs:documentation> </xs:documentation> </xs:annotation> <xs:complexContent> <xs:extension base="MessageBody"> <xs:sequence> <xs:element ref="D2001_SPID"/> <xs:element ref="D2042_LiveRateableValue"/> <xs:element ref="D4006_EffectiveFrom"/> </xs:sequence> </xs:extension> </xs:complexContent> </xs:complexType> </pre> | | | | | | | | | | | | | | | | | | |

```

</xs:extension>
</xs:complexContent>
</xs:complexType>

```

complexType T012.8_UpdateLiveRateableValueNotificationType

| | | | | | | |
|------------|-----------------------------------------------------------------------------------------------------------------------------------------------------------------------------------------------------------------------------------------------------------------------------------------------------------------------------------------------------------------------------------------------------------------------------------------------------------------------------------------------------------------------------------------------------------------------------------------------------------------------------------------------------------------------------------------------------------------------------------------------------------------------------------------------------------------------------------------------------------------------------------------------------------------------------------------------------|-------------------------------|----------|---------|-------|------------|
| diagram | <p>The diagram illustrates the structure of the <code>T012.8_UpdateLiveRateableValueNotificationType</code> complex type. It is an extension of the <code>MessageBody</code> type. The <code>MessageBody</code> extension contains an <code>attributes</code> container with two elements: <code>MID</code> (required) and <code>RelatedMID</code> (optional). The main complex type contains a sequence of three elements: <code>D2001_SPID</code> (required), <code>D2042_LiveRateableValue</code> (required), and <code>D4006_EffectiveFrom</code> (required). The <code>D2001_SPID</code> element is described as 'D2001 Unique identifier that Identifies each supply point and the service provided'. The <code>D2042_LiveRateableValue</code> element is described as 'Live Rateable Value of Eligible Premises in [£]'. The <code>D4006_EffectiveFrom</code> element is described as 'Details the date any data may be effective from'.</p> | | | | | |
| namespace | urn:bridgeall-com:cmaservice:data:v3 | | | | | |
| type | extension of MessageBody | | | | | |
| properties | base <code>MessageBody</code> | | | | | |
| children | D2001_SPID D2042_LiveRateableValue D4006_EffectiveFrom | | | | | |
| used by | element ResponseMessages/Response/T012.8_UpdateLiveRateableValueNotification | | | | | |
| attributes | Name | Type | Use | Default | Fixed | annotation |
| | MID | MessageIdType | required | | | |
| | RelatedMID | MessageIdType | optional | | | |
| annotation | documentation | | | | | |
| source | <pre> <xs:complexType name="T012.8_UpdateLiveRateableValueNotificationType"> <xs:annotation> <xs:documentation> </xs:documentation> </xs:annotation> <xs:complexContent> <xs:extension base="MessageBody"> <xs:sequence> <xs:element ref="D2001_SPID"/> <xs:element ref="D2042_LiveRateableValue"/> <xs:element ref="D4006_EffectiveFrom"/> </xs:sequence> </xs:extension> </xs:complexContent> </xs:complexType> </pre> | | | | | |

complexType **T016.0_UnmeasureableDeclarationType**

| diagram | | | | | | | | | | | | | | | | | | | |
|----------------------------|--------------------------------------------------------------------------------------------------------------------------------------------------------------------------------------------------------------------------------------------------------------------------------------------------------------------------------------------------------------------------------------------------------------------------------------------------------------------------------------------------------------------------------------------------------------------------------------|----------|---------|-------|------------|-------|------------|---------------------|-------------------------------|----------|--|--|--|----------------------------|-------------------------------|----------|--|--|--|
| namespace | urn:bridgeall-com:cmaservice:data:v3 | | | | | | | | | | | | | | | | | | |
| type | extension of MessageBody | | | | | | | | | | | | | | | | | | |
| properties | base MessageBody | | | | | | | | | | | | | | | | | | |
| children | D2001_SPID D2024_Unmeasurable D4006_EffectiveFrom | | | | | | | | | | | | | | | | | | |
| used by | elements MessagesType/T016.0_UnmeasureableDeclarations/T016.0_UnmeasureableDeclaration ResponseMessagesType/T016.1_UnmeasureableNotification | | | | | | | | | | | | | | | | | | |
| attributes | <table border="1"> <thead> <tr> <th>Name</th> <th>Type</th> <th>Use</th> <th>Default</th> <th>Fixed</th> <th>annotation</th> </tr> </thead> <tbody> <tr> <td>MID</td> <td>MessageIdType</td> <td>required</td> <td></td> <td></td> <td></td> </tr> <tr> <td>RelatedMID</td> <td>MessageIdType</td> <td>optional</td> <td></td> <td></td> <td></td> </tr> </tbody> </table> | Name | Type | Use | Default | Fixed | annotation | MID | MessageIdType | required | | | | RelatedMID | MessageIdType | optional | | | |
| Name | Type | Use | Default | Fixed | annotation | | | | | | | | | | | | | | |
| MID | MessageIdType | required | | | | | | | | | | | | | | | | | |
| RelatedMID | MessageIdType | optional | | | | | | | | | | | | | | | | | |
| annotation | documentation | | | | | | | | | | | | | | | | | | |
| source | <pre><xs:complexType name="T016.0_UnmeasureableDeclarationType"> <xs:annotation> <xs:documentation> </xs:documentation> </xs:annotation> <xs:complexContent> <xs:extension base="MessageBody"> <xs:sequence> <xs:element ref="D2001_SPID"/> <xs:element ref="D2024_Unmeasurable"/> <xs:element ref="D4006_EffectiveFrom"/> </xs:sequence> </xs:extension> </xs:complexContent> </xs:complexType></pre> | | | | | | | | | | | | | | | | | | |

complexType **T032.0_CreateUpdateCustomerNameType**

| <p>diagram</p> | <p>The diagram illustrates the structure of the T032.0_CreateUpdateCustomerNameType complex type. It is an extension of MessageBody. The MessageBody (extension) contains an attributes container with two elements: MID (required) and RelatedMID (optional). The T032.0_CreateUpdateCustomerNameType contains a sequence of three elements: D2001_SPID (required), D2027_CustomerName (required), and D2028_CustomerNameType (required). The D2001_SPID element is described as "D2001 Unique identifier that Identifies each supply point and the service provided". The D2027_CustomerName element is described as "D2027 Customer Name that owns a SPID". The D2028_CustomerNameType element is described as "D2028 Flag to indicate the customer name type".</p> | | | | | | | | | | | | | | | | | | |
|----------------------------|-------------------------------------------------------------------------------------------------------------------------------------------------------------------------------------------------------------------------------------------------------------------------------------------------------------------------------------------------------------------------------------------------------------------------------------------------------------------------------------------------------------------------------------------------------------------------------------------------------------------------------------------------------------------------------------------------------------------------------------------------------------------------------------------------------------------------------------------------------------------|----------|---------|-------|------------|-------|------------|---------------------|-------------------------------|----------|--|--|--|----------------------------|-------------------------------|----------|--|--|--|
| <p>namespace</p> | <p>urn:bridgeall-com:cmaservice:data:v3</p> | | | | | | | | | | | | | | | | | | |
| <p>type</p> | <p>extension of MessageBody</p> | | | | | | | | | | | | | | | | | | |
| <p>properties</p> | <p>base MessageBody</p> | | | | | | | | | | | | | | | | | | |
| <p>children</p> | <p>D2001_SPID D2027_CustomerName D2028_CustomerNameType</p> | | | | | | | | | | | | | | | | | | |
| <p>used by</p> | <p>element MessagesType/T032.0_CreateUpdateCustomerName/T032.0_CreateUpdateCustomerName</p> | | | | | | | | | | | | | | | | | | |
| <p>attributes</p> | <table border="1"> <thead> <tr> <th>Name</th> <th>Type</th> <th>Use</th> <th>Default</th> <th>Fixed</th> <th>annotation</th> </tr> </thead> <tbody> <tr> <td>MID</td> <td>MessageIdType</td> <td>required</td> <td></td> <td></td> <td></td> </tr> <tr> <td>RelatedMID</td> <td>MessageIdType</td> <td>optional</td> <td></td> <td></td> <td></td> </tr> </tbody> </table> | Name | Type | Use | Default | Fixed | annotation | MID | MessageIdType | required | | | | RelatedMID | MessageIdType | optional | | | |
| Name | Type | Use | Default | Fixed | annotation | | | | | | | | | | | | | | |
| MID | MessageIdType | required | | | | | | | | | | | | | | | | | |
| RelatedMID | MessageIdType | optional | | | | | | | | | | | | | | | | | |
| <p>annotation</p> | <p>documentation</p> | | | | | | | | | | | | | | | | | | |
| <p>source</p> | <pre><xs:complexType name="T032.0_CreateUpdateCustomerNameType"> <xs:annotation> <xs:documentation> </xs:documentation> </xs:annotation> <xs:complexContent> <xs:extension base="MessageBody"> <xs:sequence> <xs:element ref="D2001_SPID"/> <xs:element ref="D2027_CustomerName"/> <xs:element ref="D2028_CustomerNameType"/> </xs:sequence> </xs:extension> </xs:complexContent> </xs:complexType></pre> | | | | | | | | | | | | | | | | | | |

complexType **T032.1_CustomerNameUpdatedType**

| <p>diagram</p> | <p>The diagram illustrates the structure of the complex type T032.1_CustomerNameUpdatedType. It is an extension of MessageBody. The MessageBody (extension) contains an attributes container with MID and RelatedMID. The T032.1_CustomerNameUpdatedType contains a sequence of D2001_SPID, D2027_CustomerName, and D2028_CustomerNameType.</p> <p>D2001_SPID: D2001 Unique identifier that Identifies each supply point and the service provided</p> <p>D2027_CustomerName: D2027 Customer Name that owns a SPID</p> <p>D2028_CustomerNameType: D2028 Flag to indicate the customer name type</p> | | | | | | | | | | | | | | | | | | |
|----------------------------|-----------------------------------------------------------------------------------------------------------------------------------------------------------------------------------------------------------------------------------------------------------------------------------------------------------------------------------------------------------------------------------------------------------------------------------------------------------------------------------------------------------------------------------------------------------------------------------------------------------------------------------------------------------------------------------------------|----------|---------|-------|------------|-------|------------|---------------------|-------------------------------|----------|--|--|--|----------------------------|-------------------------------|----------|--|--|--|
| <p>namespace</p> | <p>urn:bridgeall-com:cmaservice:data:v3</p> | | | | | | | | | | | | | | | | | | |
| <p>type</p> | <p>extension of MessageBody</p> | | | | | | | | | | | | | | | | | | |
| <p>properties</p> | <p>base MessageBody</p> | | | | | | | | | | | | | | | | | | |
| <p>children</p> | <p>D2001_SPID D2027_CustomerName D2028_CustomerNameType</p> | | | | | | | | | | | | | | | | | | |
| <p>used by</p> | <p>element ResponseMessagesType/T032.1_CustomerNameUpdated</p> | | | | | | | | | | | | | | | | | | |
| <p>attributes</p> | <table border="1"> <thead> <tr> <th>Name</th> <th>Type</th> <th>Use</th> <th>Default</th> <th>Fixed</th> <th>annotation</th> </tr> </thead> <tbody> <tr> <td>MID</td> <td>MessageIdType</td> <td>required</td> <td></td> <td></td> <td></td> </tr> <tr> <td>RelatedMID</td> <td>MessageIdType</td> <td>optional</td> <td></td> <td></td> <td></td> </tr> </tbody> </table> | Name | Type | Use | Default | Fixed | annotation | MID | MessageIdType | required | | | | RelatedMID | MessageIdType | optional | | | |
| Name | Type | Use | Default | Fixed | annotation | | | | | | | | | | | | | | |
| MID | MessageIdType | required | | | | | | | | | | | | | | | | | |
| RelatedMID | MessageIdType | optional | | | | | | | | | | | | | | | | | |
| <p>annotation</p> | <p>documentation</p> | | | | | | | | | | | | | | | | | | |
| <p>source</p> | <pre><xs:complexType name="T032.1_CustomerNameUpdatedType"> <xs:annotation> <xs:documentation> </xs:documentation> </xs:annotation> <xs:complexContent> <xs:extension base="MessageBody"> <xs:sequence> <xs:element ref="D2001_SPID"/> <xs:element ref="D2027_CustomerName"/> <xs:element ref="D2028_CustomerNameType"/> </xs:sequence> </xs:extension> </xs:complexContent> </xs:complexType></pre> | | | | | | | | | | | | | | | | | | |

complexType **T033.0_MeteredBuilding**

| diagram | <p>MessageBody (extension)</p> <ul style="list-style-type: none"> attributes <ul style="list-style-type: none"> MID (required) RelatedMID (optional) <p>T033.0_MeteredBuilding</p> <ul style="list-style-type: none"> D2001_SPID (required): D2001 Unique identifier that Identifies each supply point and the service provided D2029_MeteredBuildingWater (required): D2029 Flag to indicate if the site is a metered building construction site D2030_MeteredBuildingWaterEff... (required): D2030 Date when the SPID became a metered building construction site (if D2029 = True) or was no longer a metered building construction site (if D2029 = False) | | | | | | | | | | | | | | | | | | |
|----------------------------|-------------------------------------------------------------------------------------------------------------------------------------------------------------------------------------------------------------------------------------------------------------------------------------------------------------------------------------------------------------------------------------------------------------------------------------------------------------------------------------------------------------------------------------------------------------------------------------------------------------------------------------------------------------------------------------------------------------------------------------------------------------------|----------|---------|-------|------------|-------|------------|---------------------|-------------------------------|----------|--|--|--|----------------------------|-------------------------------|----------|--|--|--|
| namespace | urn:bridgeall-com:cmaservice:data:v3 | | | | | | | | | | | | | | | | | | |
| type | extension of MessageBody | | | | | | | | | | | | | | | | | | |
| properties | base MessageBody | | | | | | | | | | | | | | | | | | |
| children | D2001_SPID D2029_MeteredBuildingWater D2030_MeteredBuildingWaterEffectiveDate | | | | | | | | | | | | | | | | | | |
| used by | element MessagesType/T033.0_MeteredBuildings/T033.0_MeteredBuilding | | | | | | | | | | | | | | | | | | |
| attributes | <table border="1"> <thead> <tr> <th>Name</th> <th>Type</th> <th>Use</th> <th>Default</th> <th>Fixed</th> <th>annotation</th> </tr> </thead> <tbody> <tr> <td>MID</td> <td>MessageIdType</td> <td>required</td> <td></td> <td></td> <td></td> </tr> <tr> <td>RelatedMID</td> <td>MessageIdType</td> <td>optional</td> <td></td> <td></td> <td></td> </tr> </tbody> </table> | Name | Type | Use | Default | Fixed | annotation | MID | MessageIdType | required | | | | RelatedMID | MessageIdType | optional | | | |
| Name | Type | Use | Default | Fixed | annotation | | | | | | | | | | | | | | |
| MID | MessageIdType | required | | | | | | | | | | | | | | | | | |
| RelatedMID | MessageIdType | optional | | | | | | | | | | | | | | | | | |
| annotation | documentation | | | | | | | | | | | | | | | | | | |
| source | <pre> <xs:complexType name="T033.0_MeteredBuilding"> <xs:annotation> <xs:documentation> </xs:documentation> </xs:annotation> <xs:complexContent> <xs:extension base="MessageBody"> <xs:sequence> <xs:element ref="D2001_SPID"/> <xs:element ref="D2029_MeteredBuildingWater"/> <xs:element ref="D2030_MeteredBuildingWaterEffectiveDate"/> </xs:sequence> </xs:extension> </xs:complexContent> </xs:complexType> </pre> | | | | | | | | | | | | | | | | | | |

complexType **T033.1_MeteredBuildingUpdate**

| <p>diagram</p> | | | | | | | | | | | | | | | | | | | |
|----------------------------|-----------------------------------------------------------------------------------------------------------------------------------------------------------------------------------------------------------------------------------------------------------------------------------------------------------------------------------------------------------------------------------------------------------------------------------------------------------------------------------------------------------------------------------------------------------------------------------------------------------|----------|---------|-------|------------|-------|------------|---------------------|-------------------------------|----------|--|--|--|----------------------------|-------------------------------|----------|--|--|--|
| <p>namespace</p> | <p>urn:bridgeall-com:cmaservice:data:v3</p> | | | | | | | | | | | | | | | | | | |
| <p>type</p> | <p>extension of MessageBody</p> | | | | | | | | | | | | | | | | | | |
| <p>properties</p> | <p>base MessageBody</p> | | | | | | | | | | | | | | | | | | |
| <p>children</p> | <p>D2001_SPID D2029_MeteredBuildingWater D2030_MeteredBuildingWaterEffectiveDate</p> | | | | | | | | | | | | | | | | | | |
| <p>used by</p> | <p>element ResponseMessagesType/T033.1_MeteredBuildingUpdate</p> | | | | | | | | | | | | | | | | | | |
| <p>attributes</p> | <table border="1"> <thead> <tr> <th>Name</th> <th>Type</th> <th>Use</th> <th>Default</th> <th>Fixed</th> <th>annotation</th> </tr> </thead> <tbody> <tr> <td>MID</td> <td>MessageIdType</td> <td>required</td> <td></td> <td></td> <td></td> </tr> <tr> <td>RelatedMID</td> <td>MessageIdType</td> <td>optional</td> <td></td> <td></td> <td></td> </tr> </tbody> </table> | Name | Type | Use | Default | Fixed | annotation | MID | MessageIdType | required | | | | RelatedMID | MessageIdType | optional | | | |
| Name | Type | Use | Default | Fixed | annotation | | | | | | | | | | | | | | |
| MID | MessageIdType | required | | | | | | | | | | | | | | | | | |
| RelatedMID | MessageIdType | optional | | | | | | | | | | | | | | | | | |
| <p>annotation</p> | <p>documentation</p> | | | | | | | | | | | | | | | | | | |
| <p>source</p> | <pre><xs:complexType name="T033.1_MeteredBuildingUpdate"> <xs:annotation> <xs:documentation> </xs:documentation> </xs:annotation> <xs:complexContent> <xs:extension base="MessageBody"> <xs:sequence> <xs:element ref="D2001_SPID"/> <xs:element ref="D2029_MeteredBuildingWater"/> <xs:element ref="D2030_MeteredBuildingWaterEffectiveDate"/> </xs:sequence> </xs:extension> </xs:complexContent> </xs:complexType></pre> | | | | | | | | | | | | | | | | | | |

complexType **T034.0_VacSchemeApplication**

| <p>diagram</p> | <p>T034.0_VacSchemeApplication</p> <p>MessageBody (extension)</p> <ul style="list-style-type: none"> attributes <ul style="list-style-type: none"> MID (required) RelatedMID (optional) D2001_SPID (required): D2001 Unique identifier that Identifies each supply point and the service provided D4006_EffectiveFrom (required): Details the date any data may be effective from D4007_DateOfEvidence (required): Identifies the date on which evidence to support a T34.0 is compiled. D4003_Comment (optional): Generic text field for (short) comments and notes related to the transaction D4008_CryptographicHash (required): Will identify the compiled evidence and will serve to provide a fingerprint for that evidence so that any party at any time can confirm the contents of the contemporary version of the evidence. The hash algorithm used to populate this data item must be that specified in the associated D4009 Cryptographic Hash Algorithm. D4009_CryptographicHashAlgori... (required): Name of the cryptographic hash algorithm use to derive the value of an associated D4008 Cryptographic Hash. | | | | | | | | | | | | | | | | | | |
|----------------------------|-----------------------------------------------------------------------------------------------------------------------------------------------------------------------------------------------------------------------------------------------------------------------------------------------------------------------------------------------------------------------------------------------------------------------------------------------------------------------------------------------------------------------------------------------------------------------------------------------------------------------------------------------------------------------------------------------------------------------------------------------------------------------------------------------------------------------------------------------------------------------------------------------------------------------------------------------------------------------------------------------------------------------------------------------------------------------------------------------------------------------------------------------------------------------------------------------------------------------------------------------------------------------------------------------------------|----------|---------|-------|------------|-------|------------|---------------------|-------------------------------|----------|--|--|--|----------------------------|-------------------------------|----------|--|--|--|
| <p>namespace</p> | <p>urn:bridgeall-com:cmaservice:data:v3</p> | | | | | | | | | | | | | | | | | | |
| <p>type</p> | <p>extension of MessageBody</p> | | | | | | | | | | | | | | | | | | |
| <p>properties</p> | <p>base MessageBody</p> | | | | | | | | | | | | | | | | | | |
| <p>children</p> | <p>D2001_SPID D4006_EffectiveFrom D4007_DateOfEvidence D4003_Comment D4008_CryptographicHash D4009_CryptographicHashAlgorithm</p> | | | | | | | | | | | | | | | | | | |
| <p>used by</p> | <p>element MessagesType/T034.0_VacSchemeApplications/T034.0_VacSchemeApplication</p> | | | | | | | | | | | | | | | | | | |
| <p>attributes</p> | <table border="1"> <thead> <tr> <th>Name</th> <th>Type</th> <th>Use</th> <th>Default</th> <th>Fixed</th> <th>annotation</th> </tr> </thead> <tbody> <tr> <td>MID</td> <td>MessageIdType</td> <td>required</td> <td></td> <td></td> <td></td> </tr> <tr> <td>RelatedMID</td> <td>MessageIdType</td> <td>optional</td> <td></td> <td></td> <td></td> </tr> </tbody> </table> | Name | Type | Use | Default | Fixed | annotation | MID | MessageIdType | required | | | | RelatedMID | MessageIdType | optional | | | |
| Name | Type | Use | Default | Fixed | annotation | | | | | | | | | | | | | | |
| MID | MessageIdType | required | | | | | | | | | | | | | | | | | |
| RelatedMID | MessageIdType | optional | | | | | | | | | | | | | | | | | |
| <p>annotation</p> | <p>documentation</p> | | | | | | | | | | | | | | | | | | |

| | |
|--------|---------------------------------------------------------------------------------------------------------------------------------------------------------------------------------------------------------------------------------------------------------------------------------------------------------------------------------------------------------------------------------------------------------------------------------------------------------------------------------------------------------------------------------------------------------------------------------------------------------------------------------------------------------------------------------------------------------------------------------------------------------|
| source | <pre> <xs:complexType name="T034.0_VacSchemeApplication"> <xs:annotation> <xs:documentation> </xs:documentation> </xs:annotation> <xs:complexContent> <xs:extension base="MessageBody"> <xs:sequence> <xs:element ref="D2001_SPID"/> <xs:element ref="D4006_EffectiveFrom"/> <xs:element ref="D4007_DateOfEvidence"/> <xs:element ref="D4003_Comment" minOccurs="0"/> <xs:element ref="D4008_CryptographicHash"/> <xs:element ref="D4009_CryptographicHashAlgorithm"/> </xs:sequence> </xs:extension> </xs:complexContent> </xs:complexType> </pre> |
|--------|---------------------------------------------------------------------------------------------------------------------------------------------------------------------------------------------------------------------------------------------------------------------------------------------------------------------------------------------------------------------------------------------------------------------------------------------------------------------------------------------------------------------------------------------------------------------------------------------------------------------------------------------------------------------------------------------------------------------------------------------------------|

complexType **T034.1_VacSchemeGracePeriodNotification**

| | |
|-----------|-----------------------------------------------------------------------------------------------------------------------------------------------------------------------------------------------------------------------------------------------------------------------------------------------------------------------------------------------------------------------------------------------------------------------------------------------------------------------------------------------------------------------------------------|
| diagram | <p>The diagram illustrates the structure of the T034.1_VacSchemeGracePeriodNotification complex type. It is an extension of the MessageBody type. The MessageBody extension includes an attributes container with MID and RelatedMID elements. The main complex type contains a sequence of elements: D2001_SPID, D4006_EffectiveFrom, D4007_DateOfEvidence, D4003_Comment (indicated as optional with a dashed line), and D4010_VacancyChangeGracePe.</p> |
| namespace | urn:bridgeall-com:cmaservice:data:v3 |
| type | extension of MessageBody |

| | | | | | | |
|------------|---------------------------------------------------------------------------------------------------------------------------------------------------------------------------------------------------------------------------------------------------------------------------------------------------------------------------------------------------------------------------------------------------------------------------------------------------------------------------------------------------------------------------------------------------------------------------------------------------------------------------------------------------------------------------------------------------------------------------------|-------------------------------|----------|---------|-------|------------|
| properties | base MessageBody | | | | | |
| children | D2001_SPID D4006_EffectiveFrom D4007_DateOfEvidence D4003_Comment D4010_VacancyChangeGracePeriod | | | | | |
| used by | element ResponseMessagesType/T034.1_VacSchemeGracePeriodNotification | | | | | |
| attributes | Name | Type | Use | Default | Fixed | annotation |
| | MID | MessageIdType | required | | | |
| | RelatedMID | MessageIdType | optional | | | |
| annotation | documentation | | | | | |
| source | <pre> <xs:complexType name="T034.1_VacSchemeGracePeriodNotification"> <xs:annotation> <xs:documentation> </xs:documentation> </xs:annotation> <xs:complexContent> <xs:extension base="MessageBody"> <xs:sequence> <xs:element ref="D2001_SPID"/> <xs:element ref="D4006_EffectiveFrom"/> <xs:element ref="D4007_DateOfEvidence"/> <xs:element ref="D4003_Comment" minOccurs="0"/> <xs:element ref="D4010_VacancyChangeGracePeriod"/> </xs:sequence> </xs:extension> </xs:complexContent> </xs:complexType> </pre> | | | | | |

complexType **T034.2_VacSchemeGraceEndNotification**

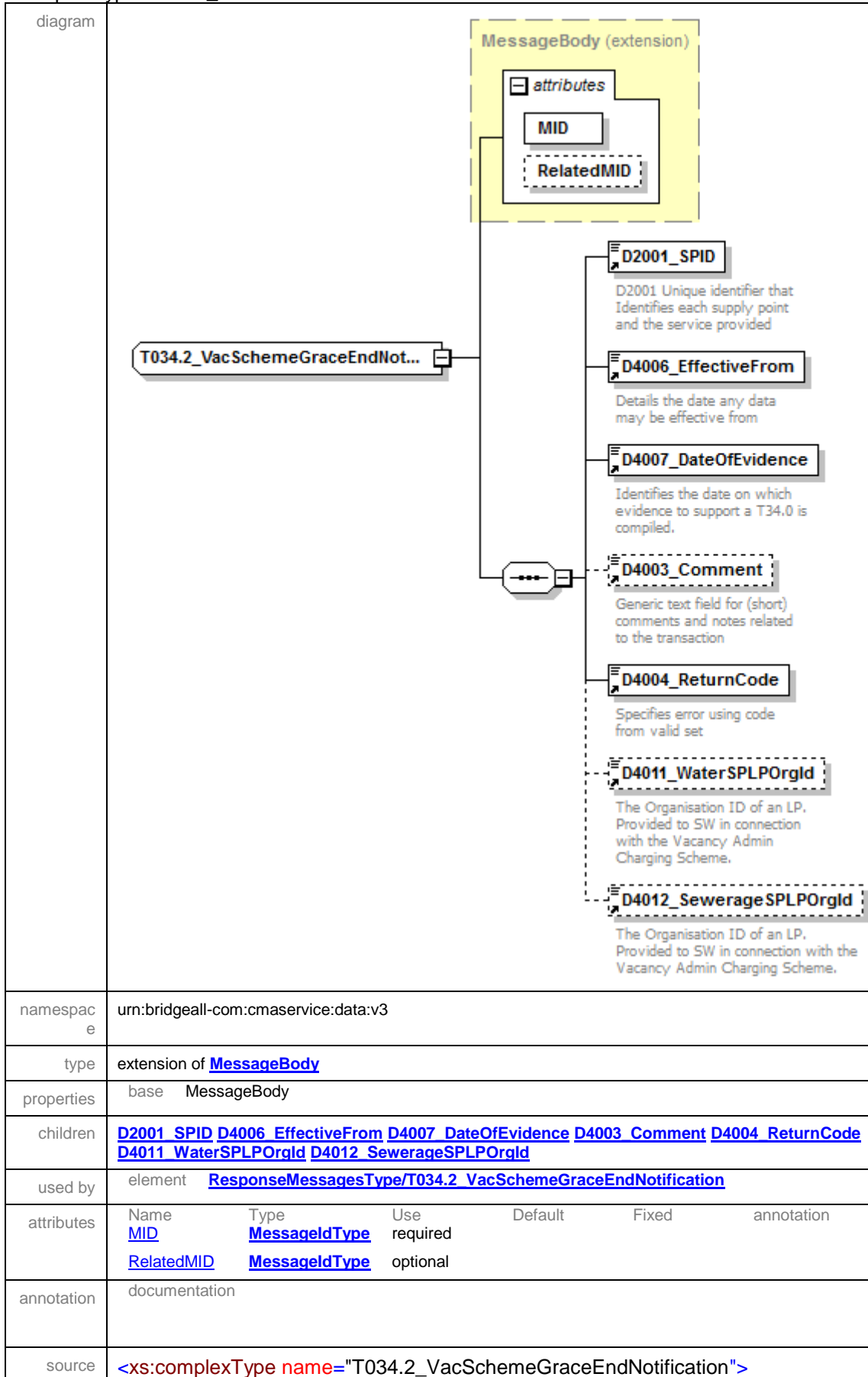

```
<xs:annotation>
  <xs:documentation>
    </xs:documentation>
</xs:annotation>
<xs:complexContent>
  <xs:extension base="MessageBody">
    <xs:sequence>
      <xs:element ref="D2001_SPID"/>
      <xs:element ref="D4006_EffectiveFrom"/>
      <xs:element ref="D4007_DateOfEvidence"/>
      <xs:element ref="D4003_Comment" minOccurs="0"/>
      <xs:element ref="D4004_ReturnCode"/>
      <xs:element ref="D4011_WaterSPLPOrgId" minOccurs="0"/>
      <xs:element ref="D4012_SewerageSPLPOrgId" minOccurs="0"/>
    </xs:sequence>
  </xs:extension>
</xs:complexContent>
</xs:complexType>
```

complexType **T034.3_VacSchemeApplicationNotification**

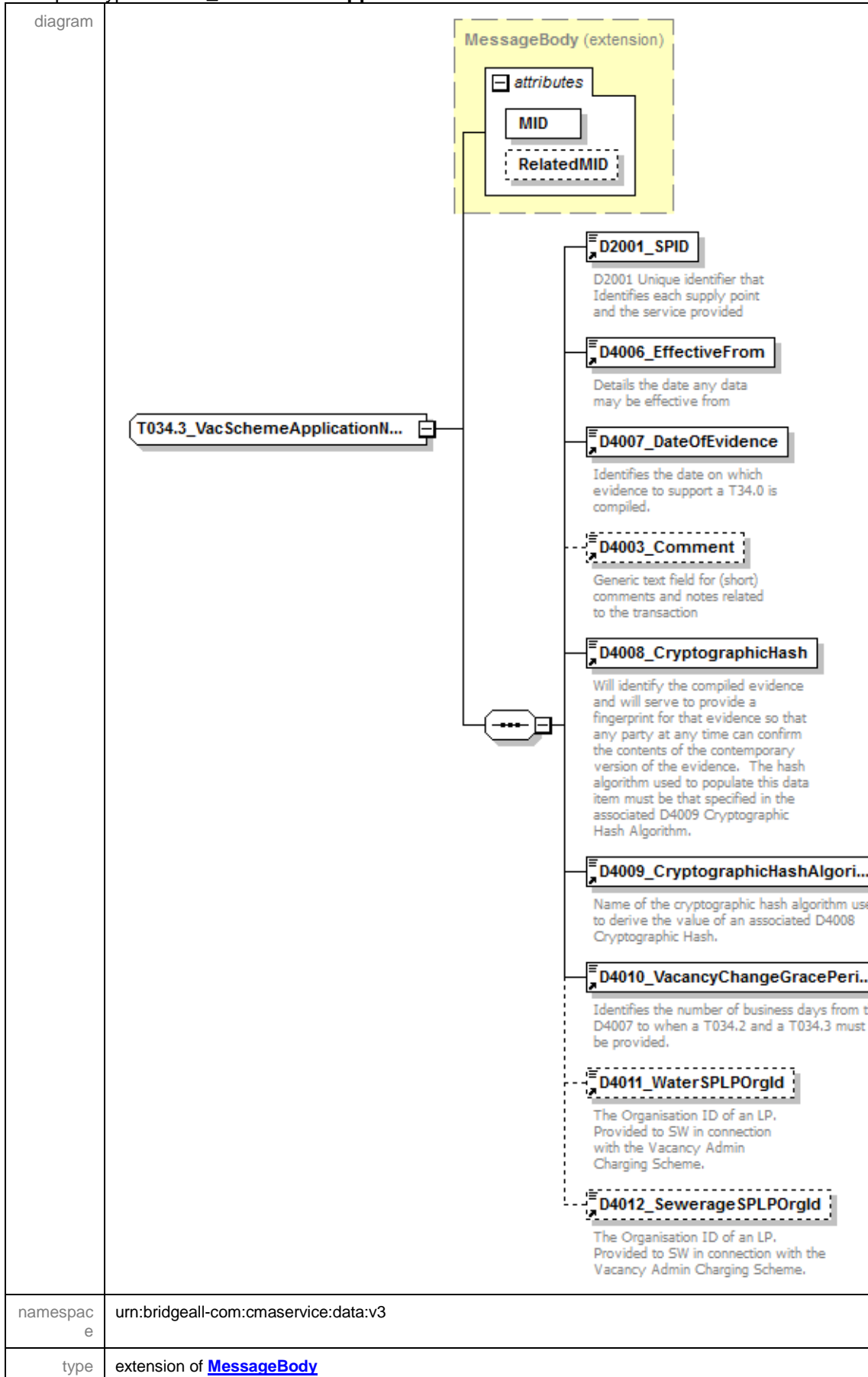

| | | | | | | |
|------------|-------------------------------------------------------------------------------------------------------------------------------------------------------------------------------------------------------------------------------------------------------------------------------------------------------------------------------------------------------------------------------------------------------------------------------------------------------------------------------------------------------------------------------------------------------------------------------------------------------------------------------------------------------------------------------------------------------------------------------------------------------------------------------------------------------------------------------------------------------------------------------------------------------------------------------------------------------------------------------------------------------------------|-------------------------------|----------|---------|-------|------------|
| properties | base MessageBody | | | | | |
| children | D2001_SPID D4006_EffectiveFrom D4007_DateOfEvidence D4003_Comment D4008_CryptographicHash D4009_CryptographicHashAlgorithm D4010_VacancyChangeGracePeriod D4011_WaterSPLPOrgld D4012_SewerageSPLPOrgld | | | | | |
| used by | element ResponseMessagesType/T034.3_VacSchemeApplicationNotification | | | | | |
| attributes | Name | Type | Use | Default | Fixed | annotation |
| | MID | MessageIdType | required | | | |
| | RelatedMID | MessageIdType | optional | | | |
| annotation | documentation | | | | | |
| source | <pre> <xs:complexType name="T034.3_VacSchemeApplicationNotification"> <xs:annotation> <xs:documentation> </xs:documentation> </xs:annotation> <xs:complexContent> <xs:extension base="MessageBody"> <xs:sequence> <xs:element ref="D2001_SPID"/> <xs:element ref="D4006_EffectiveFrom"/> <xs:element ref="D4007_DateOfEvidence"/> <xs:element ref="D4003_Comment" minOccurs="0"/> <xs:element ref="D4008_CryptographicHash"/> <xs:element ref="D4009_CryptographicHashAlgorithm"/> <xs:element ref="D4010_VacancyChangeGracePeriod"/> <xs:element ref="D4011_WaterSPLPOrgld" minOccurs="0"/> <xs:element ref="D4012_SewerageSPLPOrgld" minOccurs="0"/> </xs:sequence> </xs:extension> </xs:complexContent> </xs:complexType> </pre> | | | | | |

complexType **T034.4_VacSchemeApplicationConfirmationOrCancellation**

| | | | | | | |
|------------|--------------------------------------------------------------------------------------------------------------------------------------------------------------------------------------------------------------------------------------------------------------------------------------------------------------------------------------------------------------------------------------------------------------------------------------------------------------------------------------------------------------------------------------------------------------------------------------------------------------|-------------------------------|----------|---------|-------|------------|
| diagram | <p>The diagram illustrates the structure of the complexType T034.4_VacSchemeApplicationConfirmationOrCancellation. It is an extension of MessageBody. The MessageBody extension contains an attributes container with MID (required) and RelatedMID (optional). The main complexType contains several elements: D2001_SPID (required), D4006_EffectiveFrom (required), D4007_DateOfEvidence (required), D2031_VacancyChangeFlag (required), D2032_LPChallengedVacancyAp... (required), and D4003_Comment (optional).</p> | | | | | |
| namespace | urn:bridgeall-com:cmaservice:data:v3 | | | | | |
| type | extension of MessageBody | | | | | |
| properties | base MessageBody | | | | | |
| children | D2001_SPID D4006_EffectiveFrom D4007_DateOfEvidence D2031_VacancyChangeFlag D2032_LPChallengedVacancyApplicationFlag D4003_Comment | | | | | |
| used by | element MessagesType/T034.4_VacSchemeApplicationConfirmationOrCancellations/T034.4_VacSchemeApplicationConfirmationOrCancellation | | | | | |
| attributes | Name | Type | Use | Default | Fixed | annotation |
| | MID | MessageIdType | required | | | |
| | RelatedMID | MessageIdType | optional | | | |
| annotation | documentation | | | | | |

| | |
|--------|-----------------------------------------------------------------------------------------------------------------------------------------------------------------------------------------------------------------------------------------------------------------------------------------------------------------------------------------------------------------------------------------------------------------------------------------------------------------------------------------------------------------------------------------------------------------------------------------------------------------------------------------------------------------------------------------------------------------------------------------------------------------------------------------|
| source | <pre><xs:complexType name="T034.4_VacSchemeApplicationConfirmationOrCancellation"> <xs:annotation> <xs:documentation> </xs:documentation> </xs:annotation> <xs:complexContent> <xs:extension base="MessageBody"> <xs:sequence> <xs:element ref="D2001_SPID"/> <xs:element ref="D4006_EffectiveFrom"/> <xs:element ref="D4007_DateOfEvidence"/> <xs:element ref="D2031_VacancyChangeFlag"/> <xs:element ref="D2032_LPChallengedVacancyApplicationFlag"/> <xs:element ref="D4003_Comment" minOccurs="0"/> </xs:sequence> </xs:extension> </xs:complexContent> </xs:complexType></pre> |
|--------|-----------------------------------------------------------------------------------------------------------------------------------------------------------------------------------------------------------------------------------------------------------------------------------------------------------------------------------------------------------------------------------------------------------------------------------------------------------------------------------------------------------------------------------------------------------------------------------------------------------------------------------------------------------------------------------------------------------------------------------------------------------------------------------------|

complexType **T034.5_VacSchemeApplicationConfirmationOrCancellationNotification**

| diagram | <p>The diagram illustrates the structure of the complex type T034.5_VacSchemeApplicationConfirmationOrCancellationNotification. It is an extension of the MessageBody type. The MessageBody (extension) contains an attributes container with two elements: MID and RelatedMID. The main complex type contains several data elements: D2001_SPID, D4006_EffectiveFrom, D4007_DateOfEvidence, D2031_VacancyChangeFlag, D2032_LPChallengedVacancyApplicationFlag, and D4003_Comment. The elements D2032_LPChallengedVacancyApplicationFlag and D4003_Comment are shown with dashed boxes, indicating they are optional or not present in the current view.</p> | | | | | | | | | | | | | | | | | | |
|----------------------------|----------------------------------------------------------------------------------------------------------------------------------------------------------------------------------------------------------------------------------------------------------------------------------------------------------------------------------------------------------------------------------------------------------------------------------------------------------------------------------------------------------------------------------------------------------------------------------------------------------------------------------------------------------------------------------------------------------------------------------------------------------------|----------|---------|-------|------------|-------|------------|---------------------|-------------------------------|----------|--|--|--|----------------------------|-------------------------------|----------|--|--|--|
| namespace | urn:bridgeall-com:cmaservice:data:v3 | | | | | | | | | | | | | | | | | | |
| type | extension of MessageBody | | | | | | | | | | | | | | | | | | |
| properties | base MessageBody | | | | | | | | | | | | | | | | | | |
| children | D2001_SPID D4006_EffectiveFrom D4007_DateOfEvidence D2031_VacancyChangeFlag D2032_LPChallengedVacancyApplicationFlag D4003_Comment | | | | | | | | | | | | | | | | | | |
| used by | element ResponseMessagesType/T034.5_VacSchemeApplicationConfirmationOrCancellationNotification | | | | | | | | | | | | | | | | | | |
| attributes | <table border="1"> <thead> <tr> <th>Name</th> <th>Type</th> <th>Use</th> <th>Default</th> <th>Fixed</th> <th>annotation</th> </tr> </thead> <tbody> <tr> <td>MID</td> <td>MessageIdType</td> <td>required</td> <td></td> <td></td> <td></td> </tr> <tr> <td>RelatedMID</td> <td>MessageIdType</td> <td>optional</td> <td></td> <td></td> <td></td> </tr> </tbody> </table> | Name | Type | Use | Default | Fixed | annotation | MID | MessageIdType | required | | | | RelatedMID | MessageIdType | optional | | | |
| Name | Type | Use | Default | Fixed | annotation | | | | | | | | | | | | | | |
| MID | MessageIdType | required | | | | | | | | | | | | | | | | | |
| RelatedMID | MessageIdType | optional | | | | | | | | | | | | | | | | | |
| annotation | documentation | | | | | | | | | | | | | | | | | | |
| source | <xs:complexType name="T034.5_VacSchemeApplicationConfirmationOrCancellationNotification"> | | | | | | | | | | | | | | | | | | |

| | |
|--|-------------------------------------------------------------------------------------------------------------------------------------------------------------------------------------------------------------------------------------------------------------------------------------------------------------------------------------------------------------------------------------------------------------------------------------------------------------------------------------------------------------------------------------------------------------------------------------------------------------------------------------------------------------------|
| | <pre> <xs:annotation> <xs:documentation> </xs:documentation> </xs:annotation> <xs:complexContent> <xs:extension base="MessageBody"> <xs:sequence> <xs:element ref="D2001_SPID"/> <xs:element ref="D4006_EffectiveFrom"/> <xs:element ref="D4007_DateOfEvidence"/> <xs:element ref="D2031_VacancyChangeFlag"/> <xs:element ref="D2032_LPChallengedVacancyApplicationFlag"/> <xs:element ref="D4003_Comment" minOccurs="0"/> </xs:sequence> </xs:extension> </xs:complexContent> </xs:complexType> </pre> |
|--|-------------------------------------------------------------------------------------------------------------------------------------------------------------------------------------------------------------------------------------------------------------------------------------------------------------------------------------------------------------------------------------------------------------------------------------------------------------------------------------------------------------------------------------------------------------------------------------------------------------------------------------------------------------------|

complexType T035.0_TradeabilityNotification

| diagram | | | | | | | | | | | | | | | | | | | |
|----------------------------|--------------------------------------------------------------------------------------------------------------------------------------------------------------------------------------------------------------------------------------------------------------------------------------------------------------------------------------------------------------------------------------------------------------------------------------------|----------|---------|-------|------------|-------|------------|---------------------|-------------------------------|----------|--|--|--|----------------------------|-------------------------------|----------|--|--|--|
| namespace | urn:bridgeall-com:cmaservice:data:v3 | | | | | | | | | | | | | | | | | | |
| type | extension of MessageBody | | | | | | | | | | | | | | | | | | |
| properties | base MessageBody | | | | | | | | | | | | | | | | | | |
| children | D2001_SPID D2013_ConnectionDate | | | | | | | | | | | | | | | | | | |
| used by | element ResponseMessageType/T035.0_TradeabilityNotification | | | | | | | | | | | | | | | | | | |
| attributes | <table border="1"> <thead> <tr> <th>Name</th> <th>Type</th> <th>Use</th> <th>Default</th> <th>Fixed</th> <th>annotation</th> </tr> </thead> <tbody> <tr> <td>MID</td> <td>MessageIdType</td> <td>required</td> <td></td> <td></td> <td></td> </tr> <tr> <td>RelatedMID</td> <td>MessageIdType</td> <td>optional</td> <td></td> <td></td> <td></td> </tr> </tbody> </table> | Name | Type | Use | Default | Fixed | annotation | MID | MessageIdType | required | | | | RelatedMID | MessageIdType | optional | | | |
| Name | Type | Use | Default | Fixed | annotation | | | | | | | | | | | | | | |
| MID | MessageIdType | required | | | | | | | | | | | | | | | | | |
| RelatedMID | MessageIdType | optional | | | | | | | | | | | | | | | | | |
| annotation | documentation | | | | | | | | | | | | | | | | | | |
| source | <pre> <xs:complexType name="T035.0_TradeabilityNotification"> <xs:annotation> <xs:documentation> </xs:documentation> </xs:annotation> <xs:complexContent> </pre> | | | | | | | | | | | | | | | | | | |

```

<xs:extension base="MessageBody">
  <xs:sequence>
    <xs:element ref="D2001_SPID"/>
    <xs:element ref="D2013_ConnectionDate"/>
  </xs:sequence>
</xs:extension>
</xs:complexContent>
</xs:complexType>

```

complexType T035.1_TradeabilityNotification

| | | | | | | |
|------------|--------------------------------------------------------------------------------------------------------------------------------------------------------------------------------------------------------------------------------------------------------------------------------------------------------------------------------------------------------------------------------------------------------------------------------------------------------------------------------------------------------|-------------------------------|----------|---------|-------|------------|
| diagram | | | | | | |
| namespace | urn:bridgeall-com:cmaservice:data:v3 | | | | | |
| type | extension of MessageBody | | | | | |
| properties | base MessageBody | | | | | |
| children | D2001_SPID D2013_ConnectionDate | | | | | |
| used by | element ResponseMessagesType/T035.1_TradeabilityNotification | | | | | |
| attributes | Name | Type | Use | Default | Fixed | annotation |
| | MID | MessageIdType | required | | | |
| | RelatedMID | MessageIdType | optional | | | |
| annotation | documentation | | | | | |
| source | <pre> <xs:complexType name="T035.1_TradeabilityNotification"> <xs:annotation> <xs:documentation> </xs:documentation> </xs:annotation> <xs:complexContent> <xs:extension base="MessageBody"> <xs:sequence> <xs:element ref="D2001_SPID"/> <xs:element ref="D2013_ConnectionDate"/> </xs:sequence> </xs:extension> </xs:complexContent> </xs:complexType> </pre> | | | | | |

complexType **TEUpdateType**

| <p>diagram</p> | <p>The diagram shows the structure of the TEUpdateType complex type. It is an extension of the MessageBody type. The MessageBody extension contains an attributes container with two elements: MID (required) and RelatedMID (optional). The TEUpdateType contains a sequence of elements: D2001_SPID (required), D6001_DPID (required), D4006_EffectiveFrom (required), D6006_Ot (optional), and D6007_St (optional). Each element has a description: D2001_SPID is a unique identifier for supply points; D6001_DPID is a discharge point ID; D4006_EffectiveFrom details the effective date; D6006_Ot is TE Operating Data: Fixed Strength Chemical Oxygen Demand; and D6007_St is TE Operating Data: Fixed Strength Solids Demand.</p> | | | | | | | | | | | | | | | | | | |
|----------------------------|-------------------------------------------------------------------------------------------------------------------------------------------------------------------------------------------------------------------------------------------------------------------------------------------------------------------------------------------------------------------------------------------------------------------------------------------------------------------------------------------------------------------------------------------------------------------------------------------------------------------------------------------------------------------------------------------------------------------------------------------------------------------------------------------------------------------------------------------------------------------|----------|---------|-------|------------|-------|------------|---------------------|-------------------------------|----------|--|--|--|----------------------------|-------------------------------|----------|--|--|--|
| <p>namespace</p> | <p>urn:bridgeall-com:cmaservice:data:v3</p> | | | | | | | | | | | | | | | | | | |
| <p>type</p> | <p>extension of MessageBody</p> | | | | | | | | | | | | | | | | | | |
| <p>properties</p> | <p>base MessageBody</p> | | | | | | | | | | | | | | | | | | |
| <p>children</p> | <p>D2001_SPID D6001_DPID D4006_EffectiveFrom D6006_Ot D6007_St</p> | | | | | | | | | | | | | | | | | | |
| <p>used by</p> | <p>elements MessagesType/T022.0_TEUpdates/T022.0_TEUpdateResponseMessagesType/T022.1_TEUpdateNotification</p> | | | | | | | | | | | | | | | | | | |
| <p>attributes</p> | <table border="1"> <thead> <tr> <th>Name</th> <th>Type</th> <th>Use</th> <th>Default</th> <th>Fixed</th> <th>annotation</th> </tr> </thead> <tbody> <tr> <td>MID</td> <td>MessageIdType</td> <td>required</td> <td></td> <td></td> <td></td> </tr> <tr> <td>RelatedMID</td> <td>MessageIdType</td> <td>optional</td> <td></td> <td></td> <td></td> </tr> </tbody> </table> | Name | Type | Use | Default | Fixed | annotation | MID | MessageIdType | required | | | | RelatedMID | MessageIdType | optional | | | |
| Name | Type | Use | Default | Fixed | annotation | | | | | | | | | | | | | | |
| MID | MessageIdType | required | | | | | | | | | | | | | | | | | |
| RelatedMID | MessageIdType | optional | | | | | | | | | | | | | | | | | |
| <p>annotation</p> | <p>documentation</p> | | | | | | | | | | | | | | | | | | |
| <p>source</p> | <pre><xs:complexType name="TEUpdateType"> <xs:annotation> <xs:documentation> </xs:documentation> </xs:annotation> <xs:complexContent> <xs:extension base="MessageBody"> <xs:sequence> <xs:element ref="D2001_SPID"/> <xs:element ref="D6001_DPID"/> <xs:element ref="D4006_EffectiveFrom"/> <xs:element ref="D6006_Ot" minOccurs="0"/> <xs:element ref="D6007_St" minOccurs="0"/> </xs:sequence> </xs:extension> </xs:complexContent> </xs:complexType></pre> | | | | | | | | | | | | | | | | | | |

| | |
|--|------------------------------------------------------------------------------------------------------------|
| | <pre> </xs:sequence> </xs:extension> </xs:complexContent> </xs:complexType> </pre> |
|--|------------------------------------------------------------------------------------------------------------|

complexType TransactionHeaderType

| | |
|-----------|-----------------------------------------------------------------------------------------------------------------------------------------------------------------------------------------------------------------------------------------------------------------------------------------------------------------------------------------------------------------------------------------------------------------------------------------------------------------------------------------------------------------------------------------------------------------------------------------------------------------------------------------------------------------------------------------------------------|
| diagram | <p>The diagram illustrates the structure of the TransactionHeaderType complex type. It consists of a sequence of four elements: D1005_SenderOrgId, D1006_RecipientOrgId, D1007_TransactionTimestamp, and D1003_FlowReference. D1003_FlowReference is shown as optional with a dashed line.</p> <ul style="list-style-type: none"> D1005_SenderOrgId: D1005 Organisation ID of organisation sending data D1006_RecipientOrgId: D1006 Organisation ID of intended recipient of data D1007_TransactionTimestamp: D1007 Timestamp of data flow on send D1003_FlowReference: D1003 Provides a reference ID for flow from originating org |
| namespace | urn:bridgeall-com:cmaservice:data:v3 |
| children | D1005_SenderOrgId D1006_RecipientOrgId D1007_TransactionTimestamp D1003_FlowReference |
| used by | elements Submission/Header Response/ResponseHeader |
| source | <pre> <xs:complexType name="TransactionHeaderType"> <xs:sequence> <xs:element ref="D1005_SenderOrgId"/> <xs:element ref="D1006_RecipientOrgId"/> <xs:element ref="D1007_TransactionTimestamp"/> <xs:element ref="D1003_FlowReference" minOccurs="0"/> </xs:sequence> </xs:complexType> </pre> |

complexType UARNTType

| | |
|-----------|------------------------------------------------------------------------------------------------------------------------------------------------------------------------------------------------------------------------------------------------------------------------------------------------------------------------------------------------------------------------------------------------------------|
| diagram | <p>The diagram illustrates the structure of the UARNTType complex type. It consists of a sequence of two elements: D2037_SAAReferenceNumber and D2038_SAAReferenceNumberAbsenceCode. Both elements are shown as optional with dashed lines.</p> |
| namespace | urn:bridgeall-com:cmaservice:data:v3 |
| children | D2037_SAAReferenceNumber D2038_SAAReferenceNumberAbsenceCode |
| used by | elements NewSPIDRequestType/UARNDData NewSPIDNotificationType/UARNDData NewLPSPIDNotificationType/UARNDData UpdateSAAReferenceNumberUPRNTType/UARNDData UpdateSAAReferenceNumberUPRNNotificationType/UARNDData WaterSPIDDataTypes/UARNDData SewerageSPIDDataTypes/UARNDData |
| source | <pre> <xs:complexType name="UARNTType"> <xs:sequence> <xs:element name="D2037_SAAReferenceNumber" minOccurs="0"> <xs:simpleType> <xs:restriction base="xs:string"> <xs:maxLength value="80"/> </xs:restriction> </xs:simpleType> </xs:element> </xs:sequence> </xs:complexType> </pre> |

| | |
|--|-----------------------------------------------------------------------------------------------------------------------------------------------------------------------------------------------------------------------------------------------------------------------------------------------------------------------------------------------------------------------------|
| | <pre> <xs:whiteSpace value="preserve"/> <xs:pattern value="([A-Z][0-9][!#\$%\(\)*\+\,\-\.\/\:\;=\?][&#34;][&#62;])*"/> </xs:restriction> </xs:simpleType> </xs:element> <xs:element name="D2038_SAAReferenceNumberAbsenceCode" type="UARNAbsenceCodeType" minOccurs="0"/> </xs:sequence> </xs:complexType> </pre> |
|--|-----------------------------------------------------------------------------------------------------------------------------------------------------------------------------------------------------------------------------------------------------------------------------------------------------------------------------------------------------------------------------|

element **UARNTType/D2037_SAAReferenceNumber**

| | | | | | | | | | | | | | |
|------------|----------------------------------------------------------------------------------------------------------------------------------------------------------------------------------------------------------------------------------------------------------------------------------------------------------------------------------------------------------------------------------------|------------|-------|------------|-----------|--------|---|------------|----------|--|---------|------------------------------------------------------------|--|
| diagram | | | | | | | | | | | | | |
| namespace | urn:bridgeall-com:cmaservice:data:v3 | | | | | | | | | | | | |
| type | restriction of xs:string | | | | | | | | | | | | |
| properties | <table border="0"> <tr><td>isRef</td><td>0</td></tr> <tr><td>minOcc</td><td>0</td></tr> <tr><td>maxOcc</td><td>1</td></tr> <tr><td>content</td><td>simple</td></tr> </table> | isRef | 0 | minOcc | 0 | maxOcc | 1 | content | simple | | | | |
| isRef | 0 | | | | | | | | | | | | |
| minOcc | 0 | | | | | | | | | | | | |
| maxOcc | 1 | | | | | | | | | | | | |
| content | simple | | | | | | | | | | | | |
| facets | <table border="0"> <tr><td>Kind</td><td>Value</td><td>annotation</td></tr> <tr><td>maxLength</td><td>80</td><td></td></tr> <tr><td>whiteSpace</td><td>preserve</td><td></td></tr> <tr><td>pattern</td><td colspan="2">([A-Z][0-9][!#\$%\(\)*\+\,\-\.\/\:\;=\?][&#34;][&#62;])*</td></tr> </table> | Kind | Value | annotation | maxLength | 80 | | whiteSpace | preserve | | pattern | ([A-Z][0-9][!#\$%\(\)*\+\,\-\.\/\:\;=\?]["][>])* | |
| Kind | Value | annotation | | | | | | | | | | | |
| maxLength | 80 | | | | | | | | | | | | |
| whiteSpace | preserve | | | | | | | | | | | | |
| pattern | ([A-Z][0-9][!#\$%\(\)*\+\,\-\.\/\:\;=\?]["][>])* | | | | | | | | | | | | |
| source | <pre> <xs:element name="D2037_SAAReferenceNumber" minOccurs="0"> <xs:simpleType> <xs:restriction base="xs:string"> <xs:maxLength value="80"/> <xs:whiteSpace value="preserve"/> <xs:pattern value="([A-Z][0-9][!#\$%\(\)*\+\,\-\.\/\:\;=\?][&#34;][&#62;])*"/> </xs:restriction> </xs:simpleType> </xs:element> </pre> | | | | | | | | | | | | |

element **UARNTType/D2038_SAAReferenceNumberAbsenceCode**

| | | | | | | | | | | | | | | | | | | | | | | | | | | | | |
|-------------|-----------------------------------------------------------------------------------------------------------------------------------------------------------------------------------------------------------------------------------------------------------------------------------------------------------------------------------------------------------------------------------------------------------------------------------------------------------------------------------------------------|------------|-------|------------|-------------|--------|---|-------------|--------|--|-------------|----|--|-------------|----|--|-------------|----|--|-------------|----|--|-------------|----|--|-------------|----|--|
| diagram | | | | | | | | | | | | | | | | | | | | | | | | | | | | |
| namespace | urn:bridgeall-com:cmaservice:data:v3 | | | | | | | | | | | | | | | | | | | | | | | | | | | |
| type | UARNAbsenceCodeType | | | | | | | | | | | | | | | | | | | | | | | | | | | |
| properties | <table border="0"> <tr><td>isRef</td><td>0</td></tr> <tr><td>minOcc</td><td>0</td></tr> <tr><td>maxOcc</td><td>1</td></tr> <tr><td>content</td><td>simple</td></tr> </table> | isRef | 0 | minOcc | 0 | maxOcc | 1 | content | simple | | | | | | | | | | | | | | | | | | | |
| isRef | 0 | | | | | | | | | | | | | | | | | | | | | | | | | | | |
| minOcc | 0 | | | | | | | | | | | | | | | | | | | | | | | | | | | |
| maxOcc | 1 | | | | | | | | | | | | | | | | | | | | | | | | | | | |
| content | simple | | | | | | | | | | | | | | | | | | | | | | | | | | | |
| facets | <table border="0"> <tr><td>Kind</td><td>Value</td><td>annotation</td></tr> <tr><td>enumeration</td><td>ME</td><td></td></tr> <tr><td>enumeration</td><td>AG</td><td></td></tr> <tr><td>enumeration</td><td>SR</td><td></td></tr> <tr><td>enumeration</td><td>RC</td><td></td></tr> <tr><td>enumeration</td><td>MT</td><td></td></tr> <tr><td>enumeration</td><td>CU</td><td></td></tr> <tr><td>enumeration</td><td>IP</td><td></td></tr> <tr><td>enumeration</td><td>BW</td><td></td></tr> </table> | Kind | Value | annotation | enumeration | ME | | enumeration | AG | | enumeration | SR | | enumeration | RC | | enumeration | MT | | enumeration | CU | | enumeration | IP | | enumeration | BW | |
| Kind | Value | annotation | | | | | | | | | | | | | | | | | | | | | | | | | | |
| enumeration | ME | | | | | | | | | | | | | | | | | | | | | | | | | | | |
| enumeration | AG | | | | | | | | | | | | | | | | | | | | | | | | | | | |
| enumeration | SR | | | | | | | | | | | | | | | | | | | | | | | | | | | |
| enumeration | RC | | | | | | | | | | | | | | | | | | | | | | | | | | | |
| enumeration | MT | | | | | | | | | | | | | | | | | | | | | | | | | | | |
| enumeration | CU | | | | | | | | | | | | | | | | | | | | | | | | | | | |
| enumeration | IP | | | | | | | | | | | | | | | | | | | | | | | | | | | |
| enumeration | BW | | | | | | | | | | | | | | | | | | | | | | | | | | | |

| | |
|--------|------------------------------------------------------------------------------------------------------|
| | enumeration OT enumeration NR enumeration CP enumeration TS |
| source | <xs:element name="D2038_SAAReferenceNumberAbsenceCode" type="UARNAbsenceCodeType" minOccurs="0"/> |

complexType **UpdateMeterLocationNotificationType**

| diagram | | | | | | | | | | | | | | | | | | | |
|----------------------------|--------------------------------------------------------------------------------------------------------------------------------------------------------------------------------------------------------------------------------------------------------------------------------------------------------------------------------------------------------------------------------------------------------------------------------------------|----------|---------|-------|------------|-------|------------|---------------------|-------------------------------|----------|--|--|--|----------------------------|-------------------------------|----------|--|--|--|
| namespace | urn:bridgeall-com:cmaservice:data:v3 | | | | | | | | | | | | | | | | | | |
| type | extension of MessageBody | | | | | | | | | | | | | | | | | | |
| properties | base MessageBody | | | | | | | | | | | | | | | | | | |
| children | D2001_SPID D3001_MeterId D3019_GISZFreeDescriptor D3025_MeterLocationCode | | | | | | | | | | | | | | | | | | |
| used by | element ResponseMessagesType/T013.3 UpdateMeterLocationNotification | | | | | | | | | | | | | | | | | | |
| attributes | <table border="1"> <thead> <tr> <th>Name</th> <th>Type</th> <th>Use</th> <th>Default</th> <th>Fixed</th> <th>annotation</th> </tr> </thead> <tbody> <tr> <td>MID</td> <td>MessageIdType</td> <td>required</td> <td></td> <td></td> <td></td> </tr> <tr> <td>RelatedMID</td> <td>MessageIdType</td> <td>optional</td> <td></td> <td></td> <td></td> </tr> </tbody> </table> | Name | Type | Use | Default | Fixed | annotation | MID | MessageIdType | required | | | | RelatedMID | MessageIdType | optional | | | |
| Name | Type | Use | Default | Fixed | annotation | | | | | | | | | | | | | | |
| MID | MessageIdType | required | | | | | | | | | | | | | | | | | |
| RelatedMID | MessageIdType | optional | | | | | | | | | | | | | | | | | |
| annotation | documentation | | | | | | | | | | | | | | | | | | |
| source | <xs:complexType name="UpdateMeterLocationNotificationType"> <xs:annotation> <xs:documentation> </xs:documentation> </xs:annotation> <xs:complexContent> <xs:extension base="MessageBody"> <xs:sequence> | | | | | | | | | | | | | | | | | | |

```

<xs:element ref="D2001_SPID" minOccurs="0"/>
<xs:element ref="D3001_MeterId"/>
<xs:element ref="D3019_GISZFreeDescriptor" minOccurs="0"/>
<xs:element ref="D3025_MeterLocationCode" minOccurs="0"/>
</xs:sequence>
</xs:extension>
</xs:complexContent>
</xs:complexType>

```

complexType UpdateMeterLocationType

| diagram | | | | | | | | | | | | | | | | | | | |
|----------------------------|--------------------------------------------------------------------------------------------------------------------------------------------------------------------------------------------------------------------------------------------------------------------------------------------------------------------------------------------------------------------------------------------------------------------------------------------|----------|---------|-------|------------|-------|------------|---------------------|-------------------------------|----------|--|--|--|----------------------------|-------------------------------|----------|--|--|--|
| namespace | urn:bridgeall-com:cmaservice:data:v3 | | | | | | | | | | | | | | | | | | |
| type | extension of MessageBody | | | | | | | | | | | | | | | | | | |
| properties | base MessageBody | | | | | | | | | | | | | | | | | | |
| children | D2001_SPID D3001_MeterId D3019_GISZFreeDescriptor D3025_MeterLocationCode | | | | | | | | | | | | | | | | | | |
| used by | element MessagesType/T013.2_UpdateMeterLocations/T013.2_UpdateMeterLocation | | | | | | | | | | | | | | | | | | |
| attributes | <table border="1"> <thead> <tr> <th>Name</th> <th>Type</th> <th>Use</th> <th>Default</th> <th>Fixed</th> <th>annotation</th> </tr> </thead> <tbody> <tr> <td>MID</td> <td>MessageIdType</td> <td>required</td> <td></td> <td></td> <td></td> </tr> <tr> <td>RelatedMID</td> <td>MessageIdType</td> <td>optional</td> <td></td> <td></td> <td></td> </tr> </tbody> </table> | Name | Type | Use | Default | Fixed | annotation | MID | MessageIdType | required | | | | RelatedMID | MessageIdType | optional | | | |
| Name | Type | Use | Default | Fixed | annotation | | | | | | | | | | | | | | |
| MID | MessageIdType | required | | | | | | | | | | | | | | | | | |
| RelatedMID | MessageIdType | optional | | | | | | | | | | | | | | | | | |
| annotation | documentation | | | | | | | | | | | | | | | | | | |
| source | <pre> <xs:complexType name="UpdateMeterLocationType"> <xs:annotation> <xs:documentation> </xs:documentation> </xs:annotation> <xs:complexContent> <xs:extension base="MessageBody"> <xs:sequence> </pre> | | | | | | | | | | | | | | | | | | |

```

<xs:element ref="D2001_SPID" minOccurs="0"/>
<xs:element ref="D3001_MeterId"/>
<xs:element ref="D3019_GISZFreeDescriptor" minOccurs="0"/>
<xs:element ref="D3025_MeterLocationCode" minOccurs="0"/>
</xs:sequence>
</xs:extension>
</xs:complexContent>
</xs:complexType>

```

complexType UpdateSAARefereceNumberUPRNNotificationType

| | | | | | | |
|------------|-------------------------------------------------------------------------------------------------------------------------------------------------------------------------------------------------------------------------------------------------------------------------------------------------------------------------------------------------------------------------------------------------------------------------------------------------------------------------------------------------------------------------------------------------------------------------------------------------------------------------------------------|-------------------------------|----------|---------|-------|------------|
| diagram | | | | | | |
| namespace | urn:bridgeall-com:cmaservice:data:v3 | | | | | |
| type | extension of MessageBody | | | | | |
| properties | base MessageBody | | | | | |
| children | D2001_SPID UARNDData UPRNDData | | | | | |
| used by | element ResponseMessagesType/T012.6_UpdateSAARefereceNumberUPRNNotification | | | | | |
| attributes | Name | Type | Use | Default | Fixed | annotation |
| | MID | MessageIdType | required | | | |
| | RelatedMID | MessageIdType | optional | | | |
| annotation | documentation | | | | | |
| source | <pre> <xs:complexType name="UpdateSAARefereceNumberUPRNNotificationType"> <xs:annotation> <xs:documentation> </xs:documentation> </xs:annotation> <xs:complexContent> <xs:extension base="MessageBody"> <xs:sequence> <xs:element ref="D2001_SPID"/> <xs:element name="UARNDData" type="UARNTYPE" minOccurs="0"/> <xs:element name="UPRNDData" type="UPRNTYPE" minOccurs="0"/> </xs:sequence> </xs:extension> </xs:complexContent> </xs:complexType> </pre> | | | | | |

| | |
|--|--------------------------------------|
| | <code></xs:complexType></code> |
|--|--------------------------------------|

element **UpdateSAAResponseNumberUPRNNotificationType/UARNDData**

| | | | | | | | | | |
|------------|--------------------------------------------------------------------------------------------------------------------------------------------------------------------------------------------------------------------------------------------------------------------------------------------------------------------------------------------------------------------------------------------------------------------------------|-------|---|--------|---|--------|---|---------|---------|
| diagram | <p>The diagram illustrates the structure of the UARNDData element. It is a dashed box containing a solid box labeled 'UARNType'. Inside 'UARNType', there are two dashed boxes representing child elements: 'D2037_SAAResponseNumber' and 'D2038_SAAResponseNumberAbsenceCode'. The UARNDData element is connected to the UARNType element by a line with a small square at the end, indicating a one-to-one relationship.</p> | | | | | | | | |
| namespace | urn:bridgeall-com:cmaservice:data:v3 | | | | | | | | |
| type | UARNType | | | | | | | | |
| properties | <table border="0"> <tr><td>isRef</td><td>0</td></tr> <tr><td>minOcc</td><td>0</td></tr> <tr><td>maxOcc</td><td>1</td></tr> <tr><td>content</td><td>complex</td></tr> </table> | isRef | 0 | minOcc | 0 | maxOcc | 1 | content | complex |
| isRef | 0 | | | | | | | | |
| minOcc | 0 | | | | | | | | |
| maxOcc | 1 | | | | | | | | |
| content | complex | | | | | | | | |
| children | D2037_SAAResponseNumber D2038_SAAResponseNumberAbsenceCode | | | | | | | | |
| source | <code><xs:element name="UARNDData" type="UARNType" minOccurs="0"/></code> | | | | | | | | |

element **UpdateSAAResponseNumberUPRNNotificationType/UPRNDData**

| | | | | | | | | | |
|------------|------------------------------------------------------------------------------------------------------------------------------------------------------------------------------------------------------------------------------------------------------------------------------------------------------------------------------------------------------------------------------------------------------|-------|---|--------|---|--------|---|---------|---------|
| diagram | <p>The diagram illustrates the structure of the UPRNDData element. It is a dashed box containing a solid box labeled 'UPRNType'. Inside 'UPRNType', there are two dashed boxes representing child elements: 'D2039_UPRN' and 'D2040_UPRNAbsenceCode'. The UPRNDData element is connected to the UPRNType element by a line with a small square at the end, indicating a one-to-one relationship.</p> | | | | | | | | |
| namespace | urn:bridgeall-com:cmaservice:data:v3 | | | | | | | | |
| type | UPRNType | | | | | | | | |
| properties | <table border="0"> <tr><td>isRef</td><td>0</td></tr> <tr><td>minOcc</td><td>0</td></tr> <tr><td>maxOcc</td><td>1</td></tr> <tr><td>content</td><td>complex</td></tr> </table> | isRef | 0 | minOcc | 0 | maxOcc | 1 | content | complex |
| isRef | 0 | | | | | | | | |
| minOcc | 0 | | | | | | | | |
| maxOcc | 1 | | | | | | | | |
| content | complex | | | | | | | | |
| children | D2039_UPRN D2040_UPRNAbsenceCode | | | | | | | | |
| source | <code><xs:element name="UPRNDData" type="UPRNType" minOccurs="0"/></code> | | | | | | | | |

complexType **UpdateSAAReferenceNumberUPRNTYPE**

| | | | | | | |
|------------|--------------------------------------------------------------------------------------------------------------------------------------------------------------------------------------------------------------------------------------------------------------------------------------------------------------------------------------------------------------------------------------------------------------------------------------------------------------------------------------------------------------------------------------------------------------------------------------------------------------------------------|-------------------------------|----------|---------|-------|------------|
| diagram | | | | | | |
| namespace | urn:bridgeall-com:cmaservice:data:v3 | | | | | |
| type | extension of MessageBody | | | | | |
| properties | base MessageBody | | | | | |
| children | D2001_SPID UARNDData UPRNDData | | | | | |
| used by | element MessagesType/T012.5_UpdateSAAReferenceNumberUPRNs/T012.5_UpdateSAAReferenceNumberUPRN | | | | | |
| attributes | Name | Type | Use | Default | Fixed | annotation |
| | MID | MessageIdType | required | | | |
| | RelatedMID | MessageIdType | optional | | | |
| annotation | documentation | | | | | |
| source | <pre> <xs:complexType name="UpdateSAAReferenceNumberUPRNTYPE"> <xs:annotation> <xs:documentation> </xs:documentation> </xs:annotation> <xs:complexContent> <xs:extension base="MessageBody"> <xs:sequence> <xs:element ref="D2001_SPID"/> <xs:element name="UARNDData" type="UARNTYPE" minOccurs="0"/> <xs:element name="UPRNDData" type="UPRNTYPE" minOccurs="0"/> </xs:sequence> </xs:extension> </xs:complexContent> </xs:complexType> </pre> | | | | | |

element **UpdateSAARefereceNumberUPRNTyep/UARNDData**

| | |
|------------|--------------------------------------------------------------------------------------|
| diagram | |
| namespace | urn:bridgeall-com:cmaservice:data:v3 |
| type | UARNTyep |
| properties | isRef 0 minOcc 0 maxOcc 1 content complex |
| children | D2037_SAARefereceNumber D2038_SAARefereceNumberAb... |
| source | <xs:element name="UARNDData" type="UARNTyep" minOccurs="0"/> |

element **UpdateSAARefereceNumberUPRNTyep/UPRNDData**

| | |
|------------|-----------------------------------------------------------------|
| diagram | |
| namespace | urn:bridgeall-com:cmaservice:data:v3 |
| type | UPRNTyep |
| properties | isRef 0 minOcc 0 maxOcc 1 content complex |
| children | D2039_UPRN D2040_UPRNAbseceCode |
| source | <xs:element name="UPRNDData" type="UPRNTyep" minOccurs="0"/> |

complexType **UPRNTyep**

| | |
|-----------|----------------------------------------------------------------------------------------------------------------------------------------------------------------------------------------------------------------------------------------------------------------------------------------------------------------------------------------------------------------------------------------------------|
| diagram | |
| namespace | urn:bridgeall-com:cmaservice:data:v3 |
| children | D2039_UPRN D2040_UPRNAbseceCode |
| used by | elements NewSPIDRequestType/UPRNDData NewSPIDNotificationType/UPRNDData NewLPSPIDNotificationType/UPRNDData UpdateSAARefereceNumberUPRNTyep/UPRNDData UpdateSAARefereceNumberUPRNNotificationType/UPRNDData WaterSPIDDataType/UPRNDData SewerageSPIDDataType/UPRNDData |
| source | <xs:complexType name="UPRNTyep"> <xs:sequence> <xs:element name="D2039_UPRN" minOccurs="0"> <xs:simpleType> |

| | |
|--|----------------------------------------------------------------------------------------------------------------------------------------------------------------------------------------------------------------------------------------------------------------------------------------------------------------------------------------------------------------------------------------------------------------------------------|
| | <pre> <xs:restriction base="xs:decimal"> <xs:totalDigits value="12"/> <xs:fractionDigits value="0"/> <xs:minInclusive value="0"/> <xs:maxInclusive value="999999999999"/> </xs:restriction> </xs:simpleType> </xs:element> <xs:element name="D2040_UPRNAbsenceCode" type="UPRNAbsenceCodeType" minOccurs="0"/> </xs:sequence> </xs:complexType> </pre> |
|--|----------------------------------------------------------------------------------------------------------------------------------------------------------------------------------------------------------------------------------------------------------------------------------------------------------------------------------------------------------------------------------------------------------------------------------|

element UPRNType/D2039_UPRN

| diagram | | | | | | | | | | | | | | | | |
|----------------|------------------------------------------------------------------------------------------------------------------------------------------------------------------------------------------------------------------------------------------------------------------------------------------------------------------------------------------------------------------------------------------------|------------|-------|------------|--------------|--------|---|--------------|--------------|--|-------------|----|--|----------------|---|--|
| namespace | urn:bridgeall-com:cmaservice:data:v3 | | | | | | | | | | | | | | | |
| type | restriction of xs:decimal | | | | | | | | | | | | | | | |
| properties | <table> <tr><td>isRef</td><td>0</td></tr> <tr><td>minOcc</td><td>0</td></tr> <tr><td>maxOcc</td><td>1</td></tr> <tr><td>content</td><td>simple</td></tr> </table> | isRef | 0 | minOcc | 0 | maxOcc | 1 | content | simple | | | | | | | |
| isRef | 0 | | | | | | | | | | | | | | | |
| minOcc | 0 | | | | | | | | | | | | | | | |
| maxOcc | 1 | | | | | | | | | | | | | | | |
| content | simple | | | | | | | | | | | | | | | |
| facets | <table> <thead> <tr> <th>Kind</th> <th>Value</th> <th>annotation</th> </tr> </thead> <tbody> <tr> <td>minInclusive</td> <td>0</td> <td></td> </tr> <tr> <td>maxInclusive</td> <td>999999999999</td> <td></td> </tr> <tr> <td>totalDigits</td> <td>12</td> <td></td> </tr> <tr> <td>fractionDigits</td> <td>0</td> <td></td> </tr> </tbody> </table> | Kind | Value | annotation | minInclusive | 0 | | maxInclusive | 999999999999 | | totalDigits | 12 | | fractionDigits | 0 | |
| Kind | Value | annotation | | | | | | | | | | | | | | |
| minInclusive | 0 | | | | | | | | | | | | | | | |
| maxInclusive | 999999999999 | | | | | | | | | | | | | | | |
| totalDigits | 12 | | | | | | | | | | | | | | | |
| fractionDigits | 0 | | | | | | | | | | | | | | | |
| source | <pre> <xs:element name="D2039_UPRN" minOccurs="0"> <xs:simpleType> <xs:restriction base="xs:decimal"> <xs:totalDigits value="12"/> <xs:fractionDigits value="0"/> <xs:minInclusive value="0"/> <xs:maxInclusive value="999999999999"/> </xs:restriction> </xs:simpleType> </xs:element> </pre> | | | | | | | | | | | | | | | |

element UPRNType/D2040_UPRNAbsenceCode

| diagram | | | | | | | | | | | | | | | | |
|-------------|----------------------------------------------------------------------------------------------------------------------------------------------------------------------------------------------------------------------------------------------------------------------------------------------------------------------------------------|------------|-------|------------|-------------|--------|---|-------------|--------|--|-------------|----|--|-------------|----|--|
| namespace | urn:bridgeall-com:cmaservice:data:v3 | | | | | | | | | | | | | | | |
| type | UPRNAbsenceCodeType | | | | | | | | | | | | | | | |
| properties | <table> <tr><td>isRef</td><td>0</td></tr> <tr><td>minOcc</td><td>0</td></tr> <tr><td>maxOcc</td><td>1</td></tr> <tr><td>content</td><td>simple</td></tr> </table> | isRef | 0 | minOcc | 0 | maxOcc | 1 | content | simple | | | | | | | |
| isRef | 0 | | | | | | | | | | | | | | | |
| minOcc | 0 | | | | | | | | | | | | | | | |
| maxOcc | 1 | | | | | | | | | | | | | | | |
| content | simple | | | | | | | | | | | | | | | |
| facets | <table> <thead> <tr> <th>Kind</th> <th>Value</th> <th>annotation</th> </tr> </thead> <tbody> <tr> <td>enumeration</td> <td>ME</td> <td></td> </tr> <tr> <td>enumeration</td> <td>AG</td> <td></td> </tr> <tr> <td>enumeration</td> <td>SR</td> <td></td> </tr> <tr> <td>enumeration</td> <td>RC</td> <td></td> </tr> </tbody> </table> | Kind | Value | annotation | enumeration | ME | | enumeration | AG | | enumeration | SR | | enumeration | RC | |
| Kind | Value | annotation | | | | | | | | | | | | | | |
| enumeration | ME | | | | | | | | | | | | | | | |
| enumeration | AG | | | | | | | | | | | | | | | |
| enumeration | SR | | | | | | | | | | | | | | | |
| enumeration | RC | | | | | | | | | | | | | | | |

| | |
|--------|----------------------------------------------------------------------------------------------------------------------------|
| | enumeration MT enumeration CU enumeration IP enumeration BW enumeration OT enumeration PL enumeration TS |
| source | <xs:element name="D2040_UPRNAbsenceCode" type="UPRNAbsenceCodeType" minOccurs="0"/> |

complexType **WaterSPIDDataType**

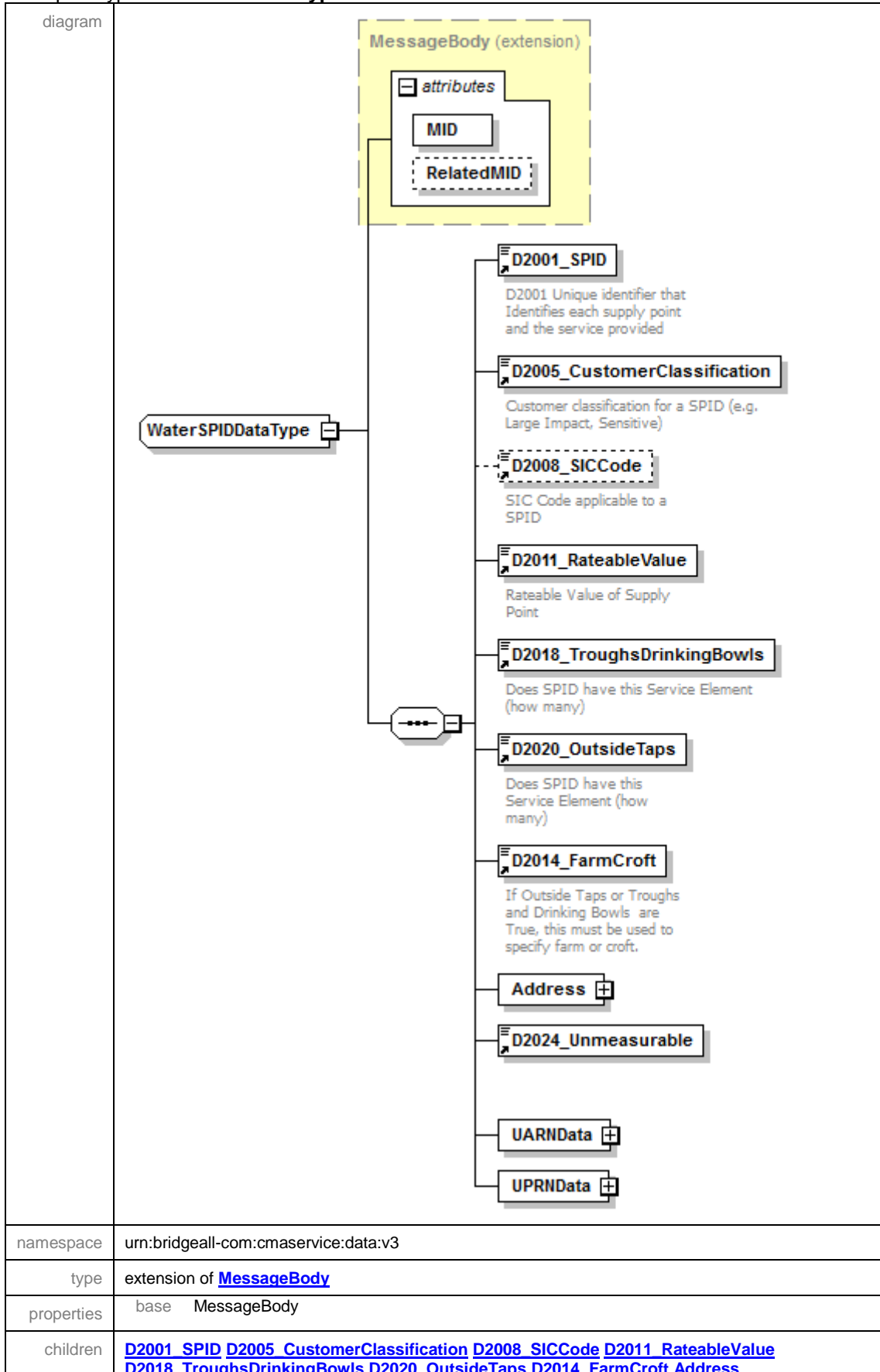

| | | | | | | |
|------------|------------------------------------------------------------------------------------------------------------------------------------------------------------------------------------------------------------------------------------------------------------------------------------------------------------------------------------------------------------------------------------------------------------------------------------------------------------------------------------------------------------------------------------------------------------------------------------------------------------------------------------------------------------------------------------------------------------------------------------------------------------------------------------------------------------------------------------------------------------------------------------------------------------------------------------------------------------------------------------------------------------------------------------------------------------------------------|-------------------------------|----------|---------|-------|------------|
| | D2024 Unmeasurable UARNDData UPRNDData | | | | | |
| used by | element ResponseMessagesType/T019.0 WaterSPIDData | | | | | |
| attributes | Name | Type | Use | Default | Fixed | annotation |
| | MID | MessageIdType | required | | | |
| | RelatedMID | MessageIdType | optional | | | |
| annotation | documentation | | | | | |
| source | <pre> <xs:complexType name="WaterSPIDDataType"> <xs:annotation> <xs:documentation> </xs:documentation> </xs:annotation> <xs:complexContent> <xs:extension base="MessageBody"> <xs:sequence> <xs:element ref="D2001_SPID"/> <xs:element ref="D2005_CustomerClassification"/> <xs:element ref="D2008_SICCode" minOccurs="0"/> <xs:element ref="D2011_RateableValue"/> <xs:element ref="D2018_TroughsDrinkingBowls"/> <xs:element ref="D2020_OutsideTaps"/> <xs:element ref="D2014_FarmCroft"/> <xs:element name="Address" type="AddressType"/> <xs:element ref="D2024_Unmeasurable"/> <xs:element name="UARNDData" type="UARNTYPE"/> <xs:element name="UPRNDData" type="UPRNTYPE"/> </xs:sequence> </xs:extension> </xs:complexContent> </xs:complexType> </pre> | | | | | |

element **WaterSPIDData/Address**

| | |
|-------------------|--------------------------------------------------------------------------------------------------------------------------------------------------------------------------------------------------------------------------------------------------------------------------------------------------------------------------------------------------------------------------------------------------------------------------------------------------------------------------------------------------------------------------------------|
| <p>diagram</p> | |
| <p>namespace</p> | <p>urn:bridgeall-com:cmaservice:data:v3</p> |
| <p>type</p> | <p>AddressType</p> |
| <p>properties</p> | <p>isRef 0 content complex</p> |
| <p>children</p> | <p>D5001_FreeDescriptor D5002_SubBuildingName D5003_BuildingName D5004_BuildingNumber D5005_DependentThoroughfareName D5006_DependentThoroughfareDescriptor D5007_ThoroughfareName D5008_ThoroughfareDescriptor D5009_DoubleDependentLocality D5010_DependentLocality D5011_PostTown D5012_County D5013_Postcode</p> |
| <p>source</p> | <p><xs:element name="Address" type="AddressType"/></p> |

element **WaterSPIDData/UARNData**

| | |
|-------------------|---------------------------------------------|
| <p>diagram</p> | |
| <p>namespace</p> | <p>urn:bridgeall-com:cmaservice:data:v3</p> |
| <p>type</p> | <p>UARNTYPE</p> |
| <p>properties</p> | <p>isRef 0 content complex</p> |

| | |
|----------|--------------------------------------------------------------------------------------------|
| children | D2037 SAAResponseNumber D2038 SAAResponseNumberAbsenceCode |
| source | <code><xs:element name="UARNDData" type="UARNTType"/></code> |

element **WaterSPIDData**/UPRNDData

| | |
|------------|------------------------------------------------------------------------------------------------------------------------------------------------------------------------------------------------|
| diagram | <p>The diagram illustrates the structure of the UPRNDData element. It is connected to the UPRNTType. Inside UPRNTType, there are two child elements: D2039_UPRN and D2040_UPRNAbsenceCode.</p> |
| namespace | urn:bridgeall-com:cmaservice:data:v3 |
| type | UPRNTType |
| properties | isRef 0 content complex |
| children | D2039 UPRN D2040 UPRNAbsenceCode |
| source | <code><xs:element name="UPRNDData" type="UPRNTType"/></code> |

simpleType **AllocationMethodType**

| namespace | urn:bridgeall-com:cmaservice:data:v3 | | | | | | | | | | | | |
|-------------------------------------|-----------------------------------------------------------------------------------------------------------------------------------------------------------------------------------------------------------------------------------------------------------------------------------------------------------------------------------------------------------------------------------------------------------------------------------------------------------------------------------------------------------------------------------------------------------|-------------------------------------|-------|------------|-----------------|-----------------|---|-------------|----------|--|-------------|-----|---|
| type | restriction of xs:string | | | | | | | | | | | | |
| properties | base xs:string | | | | | | | | | | | | |
| used by | element D2034 AllocationMethod | | | | | | | | | | | | |
| facets | <table border="1"> <thead> <tr> <th>Kind</th> <th>Value</th> <th>annotation</th> </tr> </thead> <tbody> <tr> <td>enumeration</td> <td>Associated SPID</td> <td></td> </tr> <tr> <td>enumeration</td> <td>Rotation</td> <td></td> </tr> <tr> <td>enumeration</td> <td>N/A</td> <td></td> </tr> </tbody> </table> | Kind | Value | annotation | enumeration | Associated SPID | | enumeration | Rotation | | enumeration | N/A | |
| Kind | Value | annotation | | | | | | | | | | | |
| enumeration | Associated SPID | | | | | | | | | | | | |
| enumeration | Rotation | | | | | | | | | | | | |
| enumeration | N/A | | | | | | | | | | | | |
| annotation | <p>documentation</p> <table border="1"> <tbody> <tr> <td colspan="3">Enumeration of AllocationMethodType</td> </tr> <tr> <td>Associated SPID</td> <td></td> <td>0</td> </tr> <tr> <td>Rotation</td> <td>1</td> <td></td> </tr> <tr> <td>N/A</td> <td></td> <td>2</td> </tr> </tbody> </table> | Enumeration of AllocationMethodType | | | Associated SPID | | 0 | Rotation | 1 | | N/A | | 2 |
| Enumeration of AllocationMethodType | | | | | | | | | | | | | |
| Associated SPID | | 0 | | | | | | | | | | | |
| Rotation | 1 | | | | | | | | | | | | |
| N/A | | 2 | | | | | | | | | | | |
| source | <pre> <xs:simpleType name="AllocationMethodType"> <xs:annotation> <xs:documentation> Enumeration of AllocationMethodType Associated SPID 0 Rotation 1 N/A 2 </xs:documentation> </xs:annotation> <xs:restriction base="xs:string"> <xs:enumeration value="Associated SPID"/> <xs:enumeration value="Rotation"/> <xs:enumeration value="N/A"/> </xs:restriction> </xs:simpleType> </pre> | | | | | | | | | | | | |

simpleType CancellationCodeType

| namespace | urn:bridgeall-com:cmaservice:data:v3 | | | | | | | | | | | | | | | | | | |
|-------------|--------------------------------------------------------------------------------------------------------------------------------------------------------------------------------------------------------------------------------------------------------------------------------------------------------------------------------------------------------------------------------------------------------------------------------------------------------------------------------------------------------------------------------------------------------------------------------------------------------------------------------------------------------|------------|-------|------------|-------------|---|--|-------------|---|--|-------------|---|--|-------------|---|--|-------------|---|--|
| type | restriction of xs:string | | | | | | | | | | | | | | | | | | |
| properties | base xs:string | | | | | | | | | | | | | | | | | | |
| used by | element D4005 CancellationCode | | | | | | | | | | | | | | | | | | |
| facets | <table border="1"> <thead> <tr> <th>Kind</th> <th>Value</th> <th>annotation</th> </tr> </thead> <tbody> <tr> <td>enumeration</td> <td>S</td> <td></td> </tr> <tr> <td>enumeration</td> <td>N</td> <td></td> </tr> <tr> <td>enumeration</td> <td>D</td> <td></td> </tr> <tr> <td>enumeration</td> <td>C</td> <td></td> </tr> <tr> <td>enumeration</td> <td>F</td> <td></td> </tr> </tbody> </table> | Kind | Value | annotation | enumeration | S | | enumeration | N | | enumeration | D | | enumeration | C | | enumeration | F | |
| Kind | Value | annotation | | | | | | | | | | | | | | | | | |
| enumeration | S | | | | | | | | | | | | | | | | | | |
| enumeration | N | | | | | | | | | | | | | | | | | | |
| enumeration | D | | | | | | | | | | | | | | | | | | |
| enumeration | C | | | | | | | | | | | | | | | | | | |
| enumeration | F | | | | | | | | | | | | | | | | | | |
| annotation | <p>documentation</p> <p>S SPID error (incoming LP) N No contract (incoming LP) D Outstanding debt (outgoing LP) C Contract in term (outgoing LP) F Self Supplier (outgoing LP)</p> | | | | | | | | | | | | | | | | | | |
| source | <pre><xs:simpleType name="CancellationCodeType"> <xs:annotation> <xs:documentation> S SPID error (incoming LP) N No contract (incoming LP) D Outstanding debt (outgoing LP) C Contract in term (outgoing LP) F Self Supplier (outgoing LP) </xs:documentation> </xs:annotation> <xs:restriction base="xs:string"> <xs:enumeration value="S"/> <xs:enumeration value="N"/> <xs:enumeration value="D"/> <xs:enumeration value="C"/> <xs:enumeration value="F"/> </xs:restriction> </xs:simpleType></pre> | | | | | | | | | | | | | | | | | | |

simpleType CryptographicHashAlgorithm

| namespace | urn:bridgeall-com:cmaservice:data:v3 | | | | | | |
|-------------|-------------------------------------------------------------------------------------------------------------------------------------------------------------------------------------|------------|-------|------------|-------------|--------|--|
| type | restriction of xs:string | | | | | | |
| properties | base xs:string | | | | | | |
| used by | element D4009 CryptographicHashAlgorithm | | | | | | |
| facets | <table border="1"> <thead> <tr> <th>Kind</th> <th>Value</th> <th>annotation</th> </tr> </thead> <tbody> <tr> <td>enumeration</td> <td>SHA256</td> <td></td> </tr> </tbody> </table> | Kind | Value | annotation | enumeration | SHA256 | |
| Kind | Value | annotation | | | | | |
| enumeration | SHA256 | | | | | | |
| annotation | <p>documentation</p> <p>Enumeration of Cryptographic Hash Algorithms SHA256</p> | | | | | | |
| source | <pre><xs:simpleType name="CryptographicHashAlgorithm"> <xs:annotation> <xs:documentation></pre> | | | | | | |

| | |
|--|--------------------------------------------------------------------------------------------------------------------------------------------------------------------------------------------------------------------------------------------------------------|
| | <p>Enumeration of Cryptographic Hash Algorithms SHA256</p> <pre> </xs:documentation> </xs:annotation> <xs:restriction base="xs:string"> <xs:enumeration value="SHA256"/> </xs:restriction> </xs:simpleType> </pre> |
|--|--------------------------------------------------------------------------------------------------------------------------------------------------------------------------------------------------------------------------------------------------------------|

simpleType **CustomerClassificationType**

| | | | | | | | | | | | | | |
|-------------|--------------------------------------------------------------------------------------------------------------------------------------------------------------------------------------------------------------------------------------------------------------------------------------------------------------------------------------------------------------------------------------------------------------------------------------------------------------------------------------------------------------------------------------------|------------|-------|------------|-------------|-----|--|-------------|-----|--|-------------|----|--|
| namespace | urn:bridgeall-com:cmaservice:data:v3 | | | | | | | | | | | | |
| type | restriction of xs:string | | | | | | | | | | | | |
| properties | base xs:string | | | | | | | | | | | | |
| used by | element D2005 CustomerClassification | | | | | | | | | | | | |
| facets | <table border="0"> <tr> <td>Kind</td> <td>Value</td> <td>annotation</td> </tr> <tr> <td>enumeration</td> <td>LIC</td> <td></td> </tr> <tr> <td>enumeration</td> <td>SST</td> <td></td> </tr> <tr> <td>enumeration</td> <td>NA</td> <td></td> </tr> </table> | Kind | Value | annotation | enumeration | LIC | | enumeration | SST | | enumeration | NA | |
| Kind | Value | annotation | | | | | | | | | | | |
| enumeration | LIC | | | | | | | | | | | | |
| enumeration | SST | | | | | | | | | | | | |
| enumeration | NA | | | | | | | | | | | | |
| annotation | <p>documentation</p> <p>Enumeration of Customer Classification types LIC Large Impact Customer SST Sensitive Customer NA Not Applicable</p> | | | | | | | | | | | | |
| source | <pre> <xs:simpleType name="CustomerClassificationType"> <xs:annotation> <xs:documentation> Enumeration of Customer Classification types LIC Large Impact Customer SST Sensitive Customer NA Not Applicable </xs:documentation> </xs:annotation> <xs:restriction base="xs:string"> <xs:enumeration value="LIC"/> <xs:enumeration value="SST"/> <xs:enumeration value="NA"/> </xs:restriction> </xs:simpleType> </pre> | | | | | | | | | | | | |

simpleType **CustomerNameType**

| | | | | | | | | | | |
|-------------|------------------------------------------------------------------------------------------------------------------------------------------------------------------------------------------------------------------|------------|-------|------------|-------------|----------|--|-------------|-----------|--|
| namespace | urn:bridgeall-com:cmaservice:data:v3 | | | | | | | | | |
| type | restriction of xs:string | | | | | | | | | |
| properties | base xs:string | | | | | | | | | |
| used by | element D2028 CustomerNameType | | | | | | | | | |
| facets | <table border="0"> <tr> <td>Kind</td> <td>Value</td> <td>annotation</td> </tr> <tr> <td>enumeration</td> <td>Customer</td> <td></td> </tr> <tr> <td>enumeration</td> <td>Developer</td> <td></td> </tr> </table> | Kind | Value | annotation | enumeration | Customer | | enumeration | Developer | |
| Kind | Value | annotation | | | | | | | | |
| enumeration | Customer | | | | | | | | | |
| enumeration | Developer | | | | | | | | | |
| annotation | <p>documentation</p> <p>Enumeration of Customer Name types Customer</p> | | | | | | | | | |

| | |
|--------|--------------------------------------------------------------------------------------------------------------------------------------------------------------------------------------------------------------------------------------------------------------------------------------------------------------------------------------------------------------------------------------------------------------------------------------|
| | Developer |
| source | <pre> <xs:simpleType name="CustomerNameType"> <xs:annotation> <xs:documentation> Enumeration of Customer Name types Customer Developer </xs:documentation> </xs:annotation> <xs:restriction base="xs:string"> <xs:enumeration value="Customer"/> <xs:enumeration value="Developer"/> </xs:restriction> </xs:simpleType> </pre> |

simpleType **decimal18**

| namespace | urn:bridgeall-com:cmaservice:data:v3 | | | | | | | | | | | | | | | |
|----------------|--------------------------------------------------------------------------------------------------------------------------------------------------------------------------------------------------------------------------------------------------------------------------------------------------------------------------------------------------------------|------------|-------|------------|--------------|---|--|--------------|------------|--|-------------|----|--|----------------|---|--|
| type | restriction of xs:decimal | | | | | | | | | | | | | | | |
| properties | base xs:decimal | | | | | | | | | | | | | | | |
| used by | elements D6002_TeyVe D6003_CDV D6004_sBODL D6005_TSSL D6006_Ot D6007_St | | | | | | | | | | | | | | | |
| facets | <table border="1"> <thead> <tr> <th>Kind</th> <th>Value</th> <th>annotation</th> </tr> </thead> <tbody> <tr> <td>minInclusive</td> <td>0</td> <td></td> </tr> <tr> <td>maxInclusive</td> <td>9999999999</td> <td></td> </tr> <tr> <td>totalDigits</td> <td>18</td> <td></td> </tr> <tr> <td>fractionDigits</td> <td>8</td> <td></td> </tr> </tbody> </table> | Kind | Value | annotation | minInclusive | 0 | | maxInclusive | 9999999999 | | totalDigits | 18 | | fractionDigits | 8 | |
| Kind | Value | annotation | | | | | | | | | | | | | | |
| minInclusive | 0 | | | | | | | | | | | | | | | |
| maxInclusive | 9999999999 | | | | | | | | | | | | | | | |
| totalDigits | 18 | | | | | | | | | | | | | | | |
| fractionDigits | 8 | | | | | | | | | | | | | | | |
| source | <pre> <xs:simpleType name="decimal18"> <xs:restriction base="xs:decimal"> <xs:totalDigits value="18"/> <xs:fractionDigits value="8"/> <xs:minInclusive value="0"/> <xs:maxInclusive value="9999999999"/> </xs:restriction> </xs:simpleType> </pre> | | | | | | | | | | | | | | | |

simpleType **DisconnectionReconnectionType**

| namespace | urn:bridgeall-com:cmaservice:data:v3 | | | | | | | | | | | | | | | |
|-------------|-------------------------------------------------------------------------------------------------------------------------------------------------------------------------------------------------------------------------------------------------------------------------------------------------------------------------------------------------------------|------------|-------|------------|-------------|-----|--|-------------|-------|--|-------------|-------|--|-------------|-------|--|
| type | restriction of xs:string | | | | | | | | | | | | | | | |
| properties | base xs:string | | | | | | | | | | | | | | | |
| used by | element D2025_DisconnectionReconnection | | | | | | | | | | | | | | | |
| facets | <table border="1"> <thead> <tr> <th>Kind</th> <th>Value</th> <th>annotation</th> </tr> </thead> <tbody> <tr> <td>enumeration</td> <td>REC</td> <td></td> </tr> <tr> <td>enumeration</td> <td>TDISC</td> <td></td> </tr> <tr> <td>enumeration</td> <td>PDISC</td> <td></td> </tr> <tr> <td>enumeration</td> <td>DEREG</td> <td></td> </tr> </tbody> </table> | Kind | Value | annotation | enumeration | REC | | enumeration | TDISC | | enumeration | PDISC | | enumeration | DEREG | |
| Kind | Value | annotation | | | | | | | | | | | | | | |
| enumeration | REC | | | | | | | | | | | | | | | |
| enumeration | TDISC | | | | | | | | | | | | | | | |
| enumeration | PDISC | | | | | | | | | | | | | | | |
| enumeration | DEREG | | | | | | | | | | | | | | | |
| annotation | <p>documentation</p> <p>Disconnection - Reconnection Type REC Reconnection TDISC Temporary Disconnection PDISC Permanent Disconnection</p> | | | | | | | | | | | | | | | |

| | |
|--------|--------------------------------------------------------------------------------------------------------------------------------------------------------------------------------------------------------------------------------------------------------------------------------------------------------------------------------------------------------------------------------------------------------------------------------------------------------------------------------------------------------------------------------------------------------------------------------------------------------------------------------------|
| | DEREG Deregistration |
| source | <pre> <xs:simpleType name="DisconnectionReconnectionType"> <xs:annotation> <xs:documentation> Disconnection - Reconnection Type REC Reconnection TDISC Temporary Disconnection PDISC Permanent Disconnection DEREK Deregistration </xs:documentation> </xs:annotation> <xs:restriction base="xs:string"> <xs:enumeration value="REC"/> <xs:enumeration value="TDISC"/> <xs:enumeration value="PDISC"/> <xs:enumeration value="DEREG"/> </xs:restriction> </xs:simpleType> </pre> |

simpleType FarmCroftType

| namespace | urn:bridgeall-com:cmaservice:data:v3 | | | | | | | | | | | | |
|----------------|-------------------------------------------------------------------------------------------------------------------------------------------------------------------------------------------------------------------------------------------------------------------------------------------------------------------------------------------------------------------------------------------------------------------------------------------------------------------------------------------------------|----------------|-------|------------|-------------|------|--|-------------|------------------------|--|-------------|----------------|--|
| type | restriction of xs:string | | | | | | | | | | | | |
| properties | base xs:string | | | | | | | | | | | | |
| used by | element D2014 FarmCroft | | | | | | | | | | | | |
| facets | <table border="1"> <thead> <tr> <th>Kind</th> <th>Value</th> <th>annotation</th> </tr> </thead> <tbody> <tr> <td>enumeration</td> <td>FARM</td> <td></td> </tr> <tr> <td>enumeration</td> <td>CROFT</td> <td></td> </tr> <tr> <td>enumeration</td> <td>NA</td> <td></td> </tr> </tbody> </table> | Kind | Value | annotation | enumeration | FARM | | enumeration | CROFT | | enumeration | NA | |
| Kind | Value | annotation | | | | | | | | | | | |
| enumeration | FARM | | | | | | | | | | | | |
| enumeration | CROFT | | | | | | | | | | | | |
| enumeration | NA | | | | | | | | | | | | |
| annotation | <p>documentation</p> <table border="1"> <tbody> <tr> <td>Enumeration of</td> <td></td> <td></td> </tr> <tr> <td>FARM</td> <td>Farm</td> <td></td> </tr> <tr> <td>CROFT</td> <td>Croft or Small Holding</td> <td></td> </tr> <tr> <td>NA</td> <td>Not applicable</td> <td></td> </tr> </tbody> </table> | Enumeration of | | | FARM | Farm | | CROFT | Croft or Small Holding | | NA | Not applicable | |
| Enumeration of | | | | | | | | | | | | | |
| FARM | Farm | | | | | | | | | | | | |
| CROFT | Croft or Small Holding | | | | | | | | | | | | |
| NA | Not applicable | | | | | | | | | | | | |
| source | <pre> <xs:simpleType name="FarmCroftType"> <xs:annotation> <xs:documentation> Enumeration of FARM Farm CROFT Croft or Small Holding NA Not applicable </xs:documentation> </xs:annotation> <xs:restriction base="xs:string"> <xs:enumeration value="FARM"/> <xs:enumeration value="CROFT"/> <xs:enumeration value="NA"/> </xs:restriction> </xs:simpleType> </pre> | | | | | | | | | | | | |

simpleType **MessageIdType**

| namespace | urn:bridgeall-com:cmaservice:data:v3 | | | | | | | | | | | | |
|------------|-----------------------------------------------------------------------------------------------------------------------------------------------------------------------------------------------------------------------------------------------------------------------------------------------------|------------|-------|------------|-----------|----|--|-----------|----|--|---------|--------------------|--|
| type | restriction of xs:string | | | | | | | | | | | | |
| properties | base xs:string | | | | | | | | | | | | |
| used by | attributes MessageBody/@MID MessageBody/@RelatedMID | | | | | | | | | | | | |
| facets | <table border="1"> <thead> <tr> <th>Kind</th> <th>Value</th> <th>annotation</th> </tr> </thead> <tbody> <tr> <td>minLength</td> <td>16</td> <td></td> </tr> <tr> <td>maxLength</td> <td>16</td> <td></td> </tr> <tr> <td>pattern</td> <td>([a-z][A-Z][0-9])*</td> <td></td> </tr> </tbody> </table> | Kind | Value | annotation | minLength | 16 | | maxLength | 16 | | pattern | ([a-z][A-Z][0-9])* | |
| Kind | Value | annotation | | | | | | | | | | | |
| minLength | 16 | | | | | | | | | | | | |
| maxLength | 16 | | | | | | | | | | | | |
| pattern | ([a-z][A-Z][0-9])* | | | | | | | | | | | | |
| source | <pre><xs:simpleType name="MessageIdType"> <xs:restriction base="xs:string"> <xs:maxLength value="16"/> <xs:minLength value="16"/> <xs:pattern value="([a-z][A-Z][0-9])*"/> </xs:restriction> </xs:simpleType></pre> | | | | | | | | | | | | |

simpleType **MeterLocationCodeType**

| namespace | urn:bridgeall-com:cmaservice:data:v3 | | | | | | | | | | | | | | | |
|---------------------|-----------------------------------------------------------------------------------------------------------------------------------------------------------------------------------------------------------------------------------------------------------------------------------------------------------------------------------------------------------------------------------------------------------------------------------------------------------------------------------------------------------------------------------------------------------------------------------------------------------------------------------------------------------------------------------------|--------------------------------------|-------|------------|-------------|----|-------------------------------|-------------|----|-----------------------------------|-------------|----|--------------------------------------|-------------|----|---------------------|
| type | restriction of xs:string | | | | | | | | | | | | | | | |
| properties | base xs:string | | | | | | | | | | | | | | | |
| used by | element D3025 MeterLocationCode | | | | | | | | | | | | | | | |
| facets | <table border="1"> <thead> <tr> <th>Kind</th> <th>Value</th> <th>annotation</th> </tr> </thead> <tbody> <tr> <td>enumeration</td> <td>M1</td> <td></td> </tr> <tr> <td>enumeration</td> <td>M2</td> <td></td> </tr> <tr> <td>enumeration</td> <td>M3</td> <td></td> </tr> <tr> <td>enumeration</td> <td>M4</td> <td></td> </tr> </tbody> </table> | Kind | Value | annotation | enumeration | M1 | | enumeration | M2 | | enumeration | M3 | | enumeration | M4 | |
| Kind | Value | annotation | | | | | | | | | | | | | | |
| enumeration | M1 | | | | | | | | | | | | | | | |
| enumeration | M2 | | | | | | | | | | | | | | | |
| enumeration | M3 | | | | | | | | | | | | | | | |
| enumeration | M4 | | | | | | | | | | | | | | | |
| annotation | <p>documentation</p> <table border="1"> <thead> <tr> <th>Meter Location Code</th> <th></th> <th></th> </tr> </thead> <tbody> <tr> <td>M1</td> <td>0</td> <td>Outside the property boundary</td> </tr> <tr> <td>M2</td> <td>1</td> <td>Just inside the property boundary</td> </tr> <tr> <td>M3</td> <td>2</td> <td>Further inside the property boundary</td> </tr> <tr> <td>M4</td> <td>3</td> <td>Inside the building</td> </tr> </tbody> </table> | Meter Location Code | | | M1 | 0 | Outside the property boundary | M2 | 1 | Just inside the property boundary | M3 | 2 | Further inside the property boundary | M4 | 3 | Inside the building |
| Meter Location Code | | | | | | | | | | | | | | | | |
| M1 | 0 | Outside the property boundary | | | | | | | | | | | | | | |
| M2 | 1 | Just inside the property boundary | | | | | | | | | | | | | | |
| M3 | 2 | Further inside the property boundary | | | | | | | | | | | | | | |
| M4 | 3 | Inside the building | | | | | | | | | | | | | | |
| source | <pre><xs:simpleType name="MeterLocationCodeType"> <xs:annotation> <xs:documentation> Meter Location Code M1 0 Outside the property boundary M2 1 Just inside the property boundary M3 2 Further inside the property boundary M4 3 Inside the building </xs:documentation> </xs:annotation> <xs:restriction base="xs:string"> <xs:enumeration value="M1"/> <xs:enumeration value="M2"/> <xs:enumeration value="M3"/> <xs:enumeration value="M4"/> </xs:restriction> </xs:simpleType></pre> | | | | | | | | | | | | | | | |

simpleType MeterTreatmentType

| namespace | urn:bridgeall-com:cmaservice:data:v3 | | | | | | | | | | | | | | | | | | | | | |
|------------------------------------------|--------------------------------------------------------------------------------------------------------------------------------------------------------------------------------------------------------------------------------------------------------------------------------------------------------------------------------------------------------------------------------------------------------------------------------------------------------------------------------------------------------------------------------------------------------------------------------------------------------------------------------------------------------------------------------------------------------------------------------------------------------------------------------|------------------------------------------|-------|------------|-------------|---------|---|--------------|--------------|--|-----------------|-----------------|--|------------------|------------------|--|--------------|--------------|--|-------------|-------------|--|
| type | restriction of xs:string | | | | | | | | | | | | | | | | | | | | | |
| properties | base xs:string | | | | | | | | | | | | | | | | | | | | | |
| used by | element D3022_MeterTreatment | | | | | | | | | | | | | | | | | | | | | |
| facets | <table border="1"> <thead> <tr> <th>Kind</th> <th>Value</th> <th>annotation</th> </tr> </thead> <tbody> <tr> <td>enumeration</td> <td>SWWater</td> <td>0</td> </tr> <tr> <td>enumeration</td> <td>PrivateWater</td> <td></td> </tr> <tr> <td>enumeration</td> <td>PrivateEffluent</td> <td></td> </tr> <tr> <td>enumeration</td> <td>TankeredEffluent</td> <td></td> </tr> <tr> <td>enumeration</td> <td>LogicalWater</td> <td></td> </tr> <tr> <td>enumeration</td> <td>PseudoWater</td> <td></td> </tr> </tbody> </table> | Kind | Value | annotation | enumeration | SWWater | 0 | enumeration | PrivateWater | | enumeration | PrivateEffluent | | enumeration | TankeredEffluent | | enumeration | LogicalWater | | enumeration | PseudoWater | |
| Kind | Value | annotation | | | | | | | | | | | | | | | | | | | | |
| enumeration | SWWater | 0 | | | | | | | | | | | | | | | | | | | | |
| enumeration | PrivateWater | | | | | | | | | | | | | | | | | | | | | |
| enumeration | PrivateEffluent | | | | | | | | | | | | | | | | | | | | | |
| enumeration | TankeredEffluent | | | | | | | | | | | | | | | | | | | | | |
| enumeration | LogicalWater | | | | | | | | | | | | | | | | | | | | | |
| enumeration | PseudoWater | | | | | | | | | | | | | | | | | | | | | |
| annotation | <p>documentation</p> <table border="1"> <tbody> <tr> <td colspan="3">Enumeration of Meter Treatment indicator</td> </tr> <tr> <td>SWWater</td> <td></td> <td>0</td> </tr> <tr> <td>PrivateWater</td> <td>1</td> <td></td> </tr> <tr> <td>PrivateEffluent</td> <td>2</td> <td></td> </tr> <tr> <td>TankeredEffluent</td> <td>3</td> <td></td> </tr> <tr> <td>LogicalWater</td> <td>4</td> <td></td> </tr> <tr> <td>PseudoWater</td> <td>5</td> <td></td> </tr> </tbody> </table> | Enumeration of Meter Treatment indicator | | | SWWater | | 0 | PrivateWater | 1 | | PrivateEffluent | 2 | | TankeredEffluent | 3 | | LogicalWater | 4 | | PseudoWater | 5 | |
| Enumeration of Meter Treatment indicator | | | | | | | | | | | | | | | | | | | | | | |
| SWWater | | 0 | | | | | | | | | | | | | | | | | | | | |
| PrivateWater | 1 | | | | | | | | | | | | | | | | | | | | | |
| PrivateEffluent | 2 | | | | | | | | | | | | | | | | | | | | | |
| TankeredEffluent | 3 | | | | | | | | | | | | | | | | | | | | | |
| LogicalWater | 4 | | | | | | | | | | | | | | | | | | | | | |
| PseudoWater | 5 | | | | | | | | | | | | | | | | | | | | | |
| source | <pre> <xs:simpleType name="MeterTreatmentType"> <xs:annotation> <xs:documentation> Enumeration of Meter Treatment indicator SWWater 0 PrivateWater 1 PrivateEffluent 2 TankeredEffluent 3 LogicalWater 4 PseudoWater 5 </xs:documentation> </xs:annotation> <xs:restriction base="xs:string"> <xs:enumeration value="SWWater"/> <xs:enumeration value="PrivateWater"/> <xs:enumeration value="PrivateEffluent"/> <xs:enumeration value="TankeredEffluent"/> <xs:enumeration value="LogicalWater"/> <xs:enumeration value="PseudoWater"/> </xs:restriction> </xs:simpleType> </pre> | | | | | | | | | | | | | | | | | | | | | |

simpleType NewConnectionType

| namespace | urn:bridgeall-com:cmaservice:data:v3 | | | | | | | | | |
|-------------|----------------------------------------------------------------------------------------------------------------------------------------------------------------------------------------------------------------------------------------|------------|-------|------------|-------------|-----|--|-------------|----|--|
| type | restriction of xs:string | | | | | | | | | |
| properties | base xs:string | | | | | | | | | |
| used by | element D2023_NewConnectionType | | | | | | | | | |
| facets | <table border="1"> <thead> <tr> <th>Kind</th> <th>Value</th> <th>annotation</th> </tr> </thead> <tbody> <tr> <td>enumeration</td> <td>NEW</td> <td></td> </tr> <tr> <td>enumeration</td> <td>GS</td> <td></td> </tr> </tbody> </table> | Kind | Value | annotation | enumeration | NEW | | enumeration | GS | |
| Kind | Value | annotation | | | | | | | | |
| enumeration | NEW | | | | | | | | | |
| enumeration | GS | | | | | | | | | |

| | |
|------------|---------------------------------------------------------------------------------------------------------------------------------------------------------------------------------------------------------------------------------------------------------------------------------------------------------------------------------------------------------------------------------------------------------------------------------------------------------------------------|
| | enumeration CU |
| annotation | documentation New Connection Type NEW New GS Gap Site CU Change of Use |
| source | <pre> <xs:simpleType name="NewConnectionType"> <xs:annotation> <xs:documentation> New Connection Type NEW New GS Gap Site CU Change of Use </xs:documentation> </xs:annotation> <xs:restriction base="xs:string"> <xs:enumeration value="NEW"/> <xs:enumeration value="GS"/> <xs:enumeration value="CU"/> </xs:restriction> </xs:simpleType> </pre> |

simpleType percentage

| namespace | urn:bridgeall-com:cmaservice:data:v3 | | | | | | | | | | | | | | | |
|----------------|------------------------------------------------------------------------------------------------------------------------------------------------------------------------------------------------------------------------------------------------------------------------------------------------------------------------------------------------------|------------|-------|------------|--------------|---|--|--------------|-----|--|-------------|---|--|----------------|---|--|
| type | restriction of xs:decimal | | | | | | | | | | | | | | | |
| properties | base xs:decimal | | | | | | | | | | | | | | | |
| used by | elements D2003 Schedule3 D2006 29e D2041 PcentExemption D3007 ReturnToSewerAllowance D3024 MDVol D6012 PcentAllowance | | | | | | | | | | | | | | | |
| facets | <table border="1"> <thead> <tr> <th>Kind</th> <th>Value</th> <th>annotation</th> </tr> </thead> <tbody> <tr> <td>minInclusive</td> <td>0</td> <td></td> </tr> <tr> <td>maxInclusive</td> <td>100</td> <td></td> </tr> <tr> <td>totalDigits</td> <td>5</td> <td></td> </tr> <tr> <td>fractionDigits</td> <td>2</td> <td></td> </tr> </tbody> </table> | Kind | Value | annotation | minInclusive | 0 | | maxInclusive | 100 | | totalDigits | 5 | | fractionDigits | 2 | |
| Kind | Value | annotation | | | | | | | | | | | | | | |
| minInclusive | 0 | | | | | | | | | | | | | | | |
| maxInclusive | 100 | | | | | | | | | | | | | | | |
| totalDigits | 5 | | | | | | | | | | | | | | | |
| fractionDigits | 2 | | | | | | | | | | | | | | | |
| source | <pre> <xs:simpleType name="percentage"> <xs:restriction base="xs:decimal"> <xs:totalDigits value="5"/> <xs:fractionDigits value="2"/> <xs:minInclusive value="0"/> <xs:maxInclusive value="100"/> </xs:restriction> </xs:simpleType> </pre> | | | | | | | | | | | | | | | |

simpleType ReadFrequencyType

| namespace | urn:bridgeall-com:cmaservice:data:v3 | | | | | | | | | |
|-------------|-------------------------------------------------------------------------------------------------------------------------------------------------------------------------------------------------------------------------------------|------------|-------|------------|-------------|---|--|-------------|---|--|
| type | restriction of xs:string | | | | | | | | | |
| properties | base xs:string | | | | | | | | | |
| used by | element D3011 MeterReadFrequency | | | | | | | | | |
| facets | <table border="1"> <thead> <tr> <th>Kind</th> <th>Value</th> <th>annotation</th> </tr> </thead> <tbody> <tr> <td>enumeration</td> <td>B</td> <td></td> </tr> <tr> <td>enumeration</td> <td>M</td> <td></td> </tr> </tbody> </table> | Kind | Value | annotation | enumeration | B | | enumeration | M | |
| Kind | Value | annotation | | | | | | | | |
| enumeration | B | | | | | | | | | |
| enumeration | M | | | | | | | | | |

| | |
|------------|----------------------------------------------------------------------------------------------------------------------------------------------------------------------------------------------------------------------------------------------------------------------------------------------------------------------------------------------------------------------------------------------------------------------------------------------------------------------------------|
| | enumeration N |
| annotation | documentation Enumeration of Meter Read Frequency B Bi-annually M Monthly N Never |
| source | <pre> <xs:simpleType name="ReadFrequencyType"> <xs:annotation> <xs:documentation> Enumeration of Meter Read Frequency B Bi-annually M Monthly N Never </xs:documentation> </xs:annotation> <xs:restriction base="xs:string"> <xs:enumeration value="B"/> <xs:enumeration value="M"/> <xs:enumeration value="N"/> </xs:restriction> </xs:simpleType> </pre> |

simpleType ReadType

| namespace | urn:bridgeall-com:cmaservice:data:v3 | | | | | | | | | | | | | | | | | | | | | | | | | | | | | | | | | | | | |
|-------------|--------------------------------------------------------------------------------------------------------------------------------------------------------------------------------------------------------------------------------------------------------------------------------------------------------------------------------------------------------------------------------------------------------------------------------------------------------------------------------------------------------------------------------------------------------------------------------------------------------------------------------------------------------------------------------------|------------|-------|------------|-------------|---|--|-------------|---|--|-------------|---|--|-------------|---|--|-------------|---|--|-------------|---|--|-------------|---|--|-------------|---|--|-------------|---|--|-------------|---|--|-------------|---|--|
| type | restriction of xs:string | | | | | | | | | | | | | | | | | | | | | | | | | | | | | | | | | | | | |
| properties | base xs:string | | | | | | | | | | | | | | | | | | | | | | | | | | | | | | | | | | | | |
| used by | element D3010_MeterReadType | | | | | | | | | | | | | | | | | | | | | | | | | | | | | | | | | | | | |
| facets | <table border="0"> <thead> <tr> <th>Kind</th> <th>Value</th> <th>annotation</th> </tr> </thead> <tbody> <tr><td>enumeration</td><td>O</td><td></td></tr> <tr><td>enumeration</td><td>E</td><td></td></tr> <tr><td>enumeration</td><td>I</td><td></td></tr> <tr><td>enumeration</td><td>F</td><td></td></tr> <tr><td>enumeration</td><td>C</td><td></td></tr> <tr><td>enumeration</td><td>U</td><td></td></tr> <tr><td>enumeration</td><td>T</td><td></td></tr> <tr><td>enumeration</td><td>X</td><td></td></tr> <tr><td>enumeration</td><td>Y</td><td></td></tr> <tr><td>enumeration</td><td>R</td><td></td></tr> <tr><td>enumeration</td><td>S</td><td></td></tr> </tbody> </table> | Kind | Value | annotation | enumeration | O | | enumeration | E | | enumeration | I | | enumeration | F | | enumeration | C | | enumeration | U | | enumeration | T | | enumeration | X | | enumeration | Y | | enumeration | R | | enumeration | S | |
| Kind | Value | annotation | | | | | | | | | | | | | | | | | | | | | | | | | | | | | | | | | | | |
| enumeration | O | | | | | | | | | | | | | | | | | | | | | | | | | | | | | | | | | | | | |
| enumeration | E | | | | | | | | | | | | | | | | | | | | | | | | | | | | | | | | | | | | |
| enumeration | I | | | | | | | | | | | | | | | | | | | | | | | | | | | | | | | | | | | | |
| enumeration | F | | | | | | | | | | | | | | | | | | | | | | | | | | | | | | | | | | | | |
| enumeration | C | | | | | | | | | | | | | | | | | | | | | | | | | | | | | | | | | | | | |
| enumeration | U | | | | | | | | | | | | | | | | | | | | | | | | | | | | | | | | | | | | |
| enumeration | T | | | | | | | | | | | | | | | | | | | | | | | | | | | | | | | | | | | | |
| enumeration | X | | | | | | | | | | | | | | | | | | | | | | | | | | | | | | | | | | | | |
| enumeration | Y | | | | | | | | | | | | | | | | | | | | | | | | | | | | | | | | | | | | |
| enumeration | R | | | | | | | | | | | | | | | | | | | | | | | | | | | | | | | | | | | | |
| enumeration | S | | | | | | | | | | | | | | | | | | | | | | | | | | | | | | | | | | | | |
| annotation | documentation Enumeration of Meter Read Types O Opening Read E End Read I Initial Read F Final Read C Cyclic Read U Customer Read - if Cyclic Read supplied by Customer T Transfer Read X Temporary Disconnection Y Reconnection R AMR/Remote Read S Estimated T Read | | | | | | | | | | | | | | | | | | | | | | | | | | | | | | | | | | | | |

| | |
|--------|-----------------------------------------------------------------------------------------------------------------------------------------------------------------------------------------------------------------------------------------------------------------------------------------------------------------------------------------------------------------------------------------------------------------------------------------------------------------------------------------------------------------------------------------------------------------------------------------------------------------------------------------------------------------------------------------------------------------------------------------------------------------------------------------------------------------------------------------------------------------------------------------------------------------------------------------------------------------------------------------------------------------------------|
| source | <pre> <xs:simpleType name="ReadType"> <xs:annotation> <xs:documentation> Enumeration of Meter Read Types O Opening Read E End Read I Initial Read F Final Read C Cyclic Read U Customer Read - if Cyclic Read supplied by Customer T Transfer Read X Temporary Disconnection Y Reconnection R AMR/Remote Read S Estimated T Read </xs:documentation> </xs:annotation> <xs:restriction base="xs:string"> <xs:enumeration value="O"/> <xs:enumeration value="E"/> <xs:enumeration value="I"/> <xs:enumeration value="F"/> <xs:enumeration value="C"/> <xs:enumeration value="U"/> <xs:enumeration value="T"/> <xs:enumeration value="X"/> <xs:enumeration value="Y"/> <xs:enumeration value="R"/> <xs:enumeration value="S"/> </xs:restriction> </xs:simpleType> </pre> |
|--------|-----------------------------------------------------------------------------------------------------------------------------------------------------------------------------------------------------------------------------------------------------------------------------------------------------------------------------------------------------------------------------------------------------------------------------------------------------------------------------------------------------------------------------------------------------------------------------------------------------------------------------------------------------------------------------------------------------------------------------------------------------------------------------------------------------------------------------------------------------------------------------------------------------------------------------------------------------------------------------------------------------------------------------|

simpleType ReturnCodeType

| namespace | urn:bridgeall-com:cmaservice:data:v3 | | | | | | | | | | | | | | | | | | | | | | | | | | | | | | | | | | | | | | | | | | | | | | | | |
|-------------|---------------------------------------------------------------------------------------------------------------------------------------------------------------------------------------------------------------------------------------------------------------------------------------------------------------------------------------------------------------------------------------------------------------------------------------------------------------------------------------------------------------------------------------------------------------------------------------------------------------------------------------------------------------------------------------------------------------------------------------------------------------------------------------------------------------------------------------------------------------------------------------------------------|------------|-------|------------|-------------|----|--|-------------|----|--|-------------|----|--|-------------|----|--|-------------|----|--|-------------|----|--|-------------|----|--|-------------|----|--|-------------|----|--|-------------|----|--|-------------|----|--|-------------|----|--|-------------|----|--|-------------|----|--|-------------|----|--|
| type | restriction of xs:string | | | | | | | | | | | | | | | | | | | | | | | | | | | | | | | | | | | | | | | | | | | | | | | | |
| properties | base xs:string | | | | | | | | | | | | | | | | | | | | | | | | | | | | | | | | | | | | | | | | | | | | | | | | |
| used by | element D4004 ReturnCode | | | | | | | | | | | | | | | | | | | | | | | | | | | | | | | | | | | | | | | | | | | | | | | | |
| facets | <table border="1"> <thead> <tr> <th>Kind</th> <th>Value</th> <th>annotation</th> </tr> </thead> <tbody> <tr><td>enumeration</td><td>AA</td><td></td></tr> <tr><td>enumeration</td><td>AB</td><td></td></tr> <tr><td>enumeration</td><td>AC</td><td></td></tr> <tr><td>enumeration</td><td>AD</td><td></td></tr> <tr><td>enumeration</td><td>AE</td><td></td></tr> <tr><td>enumeration</td><td>AF</td><td></td></tr> <tr><td>enumeration</td><td>AG</td><td></td></tr> <tr><td>enumeration</td><td>AH</td><td></td></tr> <tr><td>enumeration</td><td>AI</td><td></td></tr> <tr><td>enumeration</td><td>AJ</td><td></td></tr> <tr><td>enumeration</td><td>AK</td><td></td></tr> <tr><td>enumeration</td><td>AL</td><td></td></tr> <tr><td>enumeration</td><td>AM</td><td></td></tr> <tr><td>enumeration</td><td>AN</td><td></td></tr> <tr><td>enumeration</td><td>AO</td><td></td></tr> </tbody> </table> | Kind | Value | annotation | enumeration | AA | | enumeration | AB | | enumeration | AC | | enumeration | AD | | enumeration | AE | | enumeration | AF | | enumeration | AG | | enumeration | AH | | enumeration | AI | | enumeration | AJ | | enumeration | AK | | enumeration | AL | | enumeration | AM | | enumeration | AN | | enumeration | AO | |
| Kind | Value | annotation | | | | | | | | | | | | | | | | | | | | | | | | | | | | | | | | | | | | | | | | | | | | | | | |
| enumeration | AA | | | | | | | | | | | | | | | | | | | | | | | | | | | | | | | | | | | | | | | | | | | | | | | | |
| enumeration | AB | | | | | | | | | | | | | | | | | | | | | | | | | | | | | | | | | | | | | | | | | | | | | | | | |
| enumeration | AC | | | | | | | | | | | | | | | | | | | | | | | | | | | | | | | | | | | | | | | | | | | | | | | | |
| enumeration | AD | | | | | | | | | | | | | | | | | | | | | | | | | | | | | | | | | | | | | | | | | | | | | | | | |
| enumeration | AE | | | | | | | | | | | | | | | | | | | | | | | | | | | | | | | | | | | | | | | | | | | | | | | | |
| enumeration | AF | | | | | | | | | | | | | | | | | | | | | | | | | | | | | | | | | | | | | | | | | | | | | | | | |
| enumeration | AG | | | | | | | | | | | | | | | | | | | | | | | | | | | | | | | | | | | | | | | | | | | | | | | | |
| enumeration | AH | | | | | | | | | | | | | | | | | | | | | | | | | | | | | | | | | | | | | | | | | | | | | | | | |
| enumeration | AI | | | | | | | | | | | | | | | | | | | | | | | | | | | | | | | | | | | | | | | | | | | | | | | | |
| enumeration | AJ | | | | | | | | | | | | | | | | | | | | | | | | | | | | | | | | | | | | | | | | | | | | | | | | |
| enumeration | AK | | | | | | | | | | | | | | | | | | | | | | | | | | | | | | | | | | | | | | | | | | | | | | | | |
| enumeration | AL | | | | | | | | | | | | | | | | | | | | | | | | | | | | | | | | | | | | | | | | | | | | | | | | |
| enumeration | AM | | | | | | | | | | | | | | | | | | | | | | | | | | | | | | | | | | | | | | | | | | | | | | | | |
| enumeration | AN | | | | | | | | | | | | | | | | | | | | | | | | | | | | | | | | | | | | | | | | | | | | | | | | |
| enumeration | AO | | | | | | | | | | | | | | | | | | | | | | | | | | | | | | | | | | | | | | | | | | | | | | | | |

| | |
|-------------|----|
| enumeration | AP |
| enumeration | AQ |
| enumeration | AR |
| enumeration | AS |
| enumeration | AT |
| enumeration | AU |
| enumeration | AV |
| enumeration | AW |
| enumeration | AX |
| enumeration | AY |
| enumeration | AZ |
| enumeration | BA |
| enumeration | BB |
| enumeration | BC |
| enumeration | BD |
| enumeration | BE |
| enumeration | BF |
| enumeration | BG |
| enumeration | BH |
| enumeration | BI |
| enumeration | BL |
| enumeration | BN |
| enumeration | BV |
| enumeration | BZ |
| enumeration | OK |
| enumeration | DA |
| enumeration | DB |
| enumeration | DC |
| enumeration | DD |
| enumeration | DE |
| enumeration | DF |
| enumeration | DG |
| enumeration | DH |
| enumeration | DI |
| enumeration | DJ |
| enumeration | DK |
| enumeration | DL |
| enumeration | DM |
| enumeration | DN |
| enumeration | DO |
| enumeration | DP |
| enumeration | DQ |
| enumeration | DR |
| enumeration | DS |
| enumeration | DT |
| enumeration | DU |
| enumeration | DV |
| enumeration | DW |
| enumeration | DX |

| | |
|-------------|----|
| enumeration | DY |
| enumeration | DZ |
| enumeration | EA |
| enumeration | EB |
| enumeration | EC |
| enumeration | ED |
| enumeration | EE |
| enumeration | EF |
| enumeration | EG |
| enumeration | EH |
| enumeration | EI |
| enumeration | EJ |
| enumeration | EK |
| enumeration | EL |
| enumeration | EM |
| enumeration | EN |
| enumeration | EO |
| enumeration | EP |
| enumeration | EQ |
| enumeration | ER |
| enumeration | ES |
| enumeration | ET |
| enumeration | EU |
| enumeration | EV |
| enumeration | EW |
| enumeration | EX |
| enumeration | EY |
| enumeration | EZ |
| enumeration | FA |
| enumeration | FB |
| enumeration | FC |
| enumeration | FD |
| enumeration | FE |
| enumeration | FF |
| enumeration | FG |
| enumeration | FH |
| enumeration | FI |
| enumeration | FJ |
| enumeration | FK |
| enumeration | FL |
| enumeration | FM |
| enumeration | FN |
| enumeration | FO |
| enumeration | FP |
| enumeration | FQ |
| enumeration | FR |
| enumeration | FS |
| enumeration | FT |
| enumeration | FU |

| | |
|-------------|----|
| enumeration | FV |
| enumeration | FW |
| enumeration | FX |
| enumeration | FY |
| enumeration | FZ |
| enumeration | GA |
| enumeration | GB |
| enumeration | GC |
| enumeration | GD |
| enumeration | GE |
| enumeration | GF |
| enumeration | GG |
| enumeration | GH |
| enumeration | GI |
| enumeration | GJ |
| enumeration | GK |
| enumeration | GL |
| enumeration | GM |
| enumeration | GN |
| enumeration | GO |
| enumeration | GP |
| enumeration | GQ |
| enumeration | GR |
| enumeration | GS |
| enumeration | GT |
| enumeration | GU |
| enumeration | GV |
| enumeration | GW |
| enumeration | GX |
| enumeration | GY |
| enumeration | GZ |
| enumeration | HA |
| enumeration | HB |
| enumeration | HC |
| enumeration | HD |
| enumeration | HE |
| enumeration | HF |
| enumeration | HG |
| enumeration | HH |
| enumeration | HI |
| enumeration | HJ |
| enumeration | HK |
| enumeration | HL |
| enumeration | HM |
| enumeration | HN |
| enumeration | HO |
| enumeration | HP |
| enumeration | HQ |
| enumeration | HR |

| | |
|-------------|----|
| enumeration | HS |
| enumeration | HT |
| enumeration | HU |
| enumeration | HV |
| enumeration | HW |
| enumeration | HX |
| enumeration | HY |
| enumeration | HZ |
| enumeration | IA |
| enumeration | IB |
| enumeration | IC |
| enumeration | ID |
| enumeration | IE |
| enumeration | IF |
| enumeration | IG |
| enumeration | IH |
| enumeration | II |
| enumeration | IJ |
| enumeration | IK |
| enumeration | IL |
| enumeration | IM |
| enumeration | IN |
| enumeration | IO |
| enumeration | IP |
| enumeration | IQ |
| enumeration | IR |
| enumeration | IS |
| enumeration | IT |
| enumeration | IU |
| enumeration | IV |
| enumeration | IW |
| enumeration | IX |
| enumeration | IY |
| enumeration | IZ |
| enumeration | JA |
| enumeration | JB |
| enumeration | JC |
| enumeration | JD |
| enumeration | JE |
| enumeration | JF |
| enumeration | JG |
| enumeration | JH |
| enumeration | JI |
| enumeration | JJ |
| enumeration | JK |
| enumeration | JL |
| enumeration | JM |
| enumeration | JN |
| enumeration | JO |

| | |
|------------|-------------------------------------------------------------------------------------------------------------------------------------------------------------------------------------------------------------------------------------------------------------------------------------------------------------------------------------------------------------------------------------------------------------------------------------------------------------------------------------------------------------------------------------------------------------------------------------------------------------------------------------------------------------------------------------------------------------------------------------------------------------------------------------------------------------------------------------------------------------------------------------------------------------------------------------------------------------------------------------------------------------------------------------------------------------------------------------------------------------------------------------------------------------------------------------------------------------------------------------------------------------------------------------------------------------------------------------------------------------------------------------------------------------------------------------------------------------------------------------------------------------------------------------------------------------------------------------------------------------------------------|
| | <p>enumeration JP</p> <p>enumeration JQ</p> <p>enumeration JR</p> <p>enumeration JS</p> <p>enumeration JT</p> <p>enumeration JU</p> <p>enumeration JV</p> <p>enumeration JW</p> <p>enumeration JX</p> <p>enumeration JY</p> <p>enumeration JZ</p> <p>enumeration KA</p> <p>enumeration KB</p> <p>enumeration KC</p> <p>enumeration KD</p> <p>enumeration KE</p> <p>enumeration KF</p> <p>enumeration KG</p> <p>enumeration KH</p> <p>enumeration KI</p> <p>enumeration KJ</p> <p>enumeration KK</p> <p>enumeration KL</p> <p>enumeration KM</p> <p>enumeration KN</p> <p>enumeration KO</p> <p>enumeration KP</p> <p>enumeration KQ</p> <p>enumeration KR</p> <p>enumeration KS</p> <p>enumeration XA</p> |
| annotation | <p>documentation</p> <p>AA Sender must be the valid Licensed Provider.</p> <p>AB SPID must be supplied in the transaction.</p> <p>AC SPID must exist in the CMA CS.</p> <p>AD Meter Read can only be submitted as a re-read if it is an exact duplicate of a rejected Read.</p> <p>AE SPID status must be Tradable.</p> <p>AF SPID status must be New.</p> <p>AG Data Items must be submitted for the WS SPID.</p> <p>AH Meter Read Y must be greater than or equal to Meter Read X.</p> <p>AI Connection Date must be in the past.</p> <p>AJ Meter S Read Remedial Work Indicator must be provided and set to False.</p> <p>AK Registration Start Date must be within the permitted window.</p> <p>AL Licensed Provider nominated by Scottish Water has rejected the registration of the new SPID.</p> <p>AM Transfer Cancellation must be within the Cancellation Window.</p> <p>AN Meter S Read Reason Code is not valid for the provided SPID.</p> <p>AO Taps/Troughs must be qualified as Farm or Croft.</p> <p>AP Meter must be Pending or Active.</p> <p>AQ SPID transfer to other Applicant already in progress.</p> <p>AR SPID already registered to Applicant, or transfer to Applicant already pending.</p> <p>AS Cancellation request not applicable to this Licensed Provider.</p> <p>AT Meter Read Rejected: Read type inappropriate.</p> <p>AU SPID Disconnection date must be today or in the past.</p> <p>AV SPID status must be Partial or Tradable.</p> <p>AW MID must start with the Org ID for the submitting Trading Party.</p> <p>AX Effective From date predates current registration start date.</p> |

AY Meter being Swapped must be Active.
 AZ Meter can only be added to a WS SPID.
 BA MID should only contain numeric values after the Orgld.
 BB Transaction not appropriate for Pseudo Meters.
 BC Meter not associated to a SPID.
 BD Transaction rejected as MID number falls into a range that has been archived. Resend message with a new MID.
 BE Meter Read must be within its capacity limit.
 BF Meter Read for this date already exists.
 BG Licensed Provider not registered to SPID.
 BH Meter Read must be on or below its daily usage limit.
 BI Meter Read date for the New Meter must be the same or after the Old Meter Read date.
 BL Meter Read must be on or above the daily usage minimum.
 BN Meter Read must create a positive meter advance, not a small negative advance.
 BV Meter Read must create a positive meter advance, not a large negative advance.
 BZ Meter Read must create a positive advance, not a zero advance.
 DA RA; Rollover Indicator must not be present on an I or an F read.
 DB RA; Logical Water meters must either have a zero value I read or a zero value F read.
 DC Transaction must be for a WS SPID.
 DD Service Category already exists for this connection.
 DE Old and New Meters incompatible for meter swap. Old Meter is not a domestic meter.
 DF Effective From date predates previous change.
 DG MIDs submitted to the HVI are not allowed within the LVI MID range (1000000000 to 1999999999). Resend message with a new MID.
 DH Sender must be Licensed Provider on Meter Read Date.
 DI SPID has passed the switching limit.
 DJ Transaction must contain: Sender, Recipient, Timestamp, SPID.
 DK Effective From Date cannot be in the future.
 DL Sender must be wholesaler.
 DM DPID already exists.
 DN DPID is discontinued.
 DO DPID must be associated to the associated Sewerage SPID.
 DP DPID not associated with a Meter.
 DQ DPID already discontinued.
 DR DPID does not exist in the CMA CS.
 DS Sender must be the Licensed Provider for the SPID continuously from the Meter Read Date to the HVI Received at Date.
 DT A Main Meter must not previously have been a Sub Meter on a Meter Network for the same SPID and a Sub Meter must not have been a Main Meter on a Meter Network on the same SPID.
 DU For Future Use.
 DV Customer Name must conform to the required format.
 DW For Future Use.
 DX SS SPID is paired with a WS SPID with a status of Tradable or TDISC.
 DY Meter Is a Pseudo Meter.
 DZ SPID or Registration Start Date is not valid.
 EA GIS X, Y coordinates must be in Scotland.
 EB Comments field must be populated. The comment must be between 1 and 255 characters long.
 EC GIS X, Y data Incomplete.
 ED SPID must be a SS SPID.
 EE Rollover Indicator not consistent with CMA CS determination.
 EF Rollover Indicator required. CMA CS unable to determine the rollover status.
 EG SPID cannot be allocated. There are no Licensed Providers available for Gap Site allocation.
 EH For Future Use.
 EI Rollover Indicator must not be present on an O or an I read.
 EJ SPID status must not be; PDISC or DREG.
 EK For Future Use.
 EL For Future Use.
 EM For Future Use.
 EN SPID status is already TDISC.
 EO SPID status is must be TDISC.
 EP SPID must not be subject to a pending transfer for TDISC to proceed.
 EQ SPID must not be New or Partial.
 ER SPID must be New or Partial.
 ES For Future Use.
 ET SPID must not be; PDISC, DREG or REJ.
 EU SPID status must not be Unmeasureable.
 EV For Future Use.
 EW For Future Use.
 EX Licensed Provider Org ID does not match Sender Org ID.
 EY Meter does not exist in the CMA CS.
 EZ For Future Use.

| | |
|--|-------------------------------------------------------------------------------------------------------------------------------------------------------------------------------------------------------------------------------------------------------------------------------------------------------------------------------------------------------------------------------------------------------------------------------------------------------------------------------------------------------------------------------------------------------------------------------------------------------------------------------------------------------------------------------------------------------------------------------------------------------------------------------------------------------------------------------------------------------------------------------------------------------------------------------------------------------------------------------------------------------------------------------------------------------------------------------------------------------------------------------------------------------------------------------------------------------------------------------------------------------------------------------------------------------------------------------------------------------------------------------------------------------------------------------------------------------------------------------------------------------------------------------------------------------------------------------------------------------------------------------------------------------------------------------------------------------------------------------------------------------------------------------------------------------------------------------------------------------------------------------------------------------------------------------------------------------------------------------------------------------------------------------------------------------------------------------------------------------------------------------------------------------------------------------------------------------------------------------------------------------------------------------------------------------------------------------------------------------------------------------------------------------------------------------------------------------------------------------------------------------------------------------------------------------------------------------------------------------------------------------------------------------------------------------------------------------------------------------------------------------------------------------------------------------------------------------------------------------------------------------------------------------------------------------------------------------------------------------------------------------------------------------------------------------------------------------------------------------------------------------------------------------------------------------------------------------------------------------------------------------------------------------------------------------------------------------------------------------------------------------------------------------------------------------------------------------------------------------------------------------------------------------------------------------------------------------------------------------------------------------------------------------------------------------------------------------------------------------------------------------------------------------------------------------------------------------------------------------------------------------------------------------------------------------------------------------------------------------------------------------------------------------------------------------------------------------------------------------------------------------------------------------------------------------------------------------------------------------------------------------------------------------------------------------------------------------------------------------------------------------------------------------------------------------------------------------------------------------------------------------------------------|
| | <p>FA Meter already exists in the CMA CS.</p> <p>FB Transaction must include a Meter ID.</p> <p>FC Transaction must include a Meter Make.</p> <p>FD Transaction must include a Manufacturers Meter Serial Number.</p> <p>FE For Future Use.</p> <p>FF Meter Read Frequency must be N.</p> <p>FG Meter Chargeable Size must be 20mm.</p> <p>FH Meter is attached to a SPID and a SPID must be provided.</p> <p>FI For Future Use.</p> <p>FJ SPID status must be Tradable or TDISC.</p> <p>FK SPID should not be included for a Non-Market Meter.</p> <p>FL For Future Use.</p> <p>FM Meter: Both Old and New Meters must be included in the transaction.</p> <p>FN Meter: Old and/or New Meter must exist in the CMA CS.</p> <p>FO Old Meter read type must be E and/or New Meter Read type must be O, or New Meter has a previous reading.</p> <p>FP Meter must be Active.</p> <p>FQ Meter: Old and/or New Meter cannot be a Pseudo meter.</p> <p>FR Meter: Old and New Meters must contain same chargeable size and RTS.</p> <p>FS Meter: New Meter is in a Meter Network and cannot be swapped.</p> <p>FT Meter: New Meter must be Active or Pending.</p> <p>FU Sender must exist in CMA CS.</p> <p>FV Meter Read date must be later than the Effective To date of Unmeasurable Service Elements associated with the SPID.</p> <p>FW Meter Read must not be a duplicate I or a duplicate F read.</p> <p>FX Meter Read must be on a date after the last meter reading.</p> <p>FY For Future Use.</p> <p>FZ For Future Use.</p> <p>GA SPID status must be Partial.</p> <p>GB Meter Effective From date and/or Metered Building Water Flag values must be different to the current values in the CMA CS.</p> <p>GC Meter Effective From date must be on or after 1 April 2011.</p> <p>GD For Future Use.</p> <p>GE Data Items that are required have not been provided for this Meter Treatment type.</p> <p>GF SPID is New or Partial and must be Deregistered.</p> <p>GG Meter(s) at the SPID must be Discontinued.</p> <p>GH DPID(s) at the SPID must be Discontinued.</p> <p>GI Meter Read Date must be today or in the past.</p> <p>GJ SS SPID has been associated to a Tradable WS SPID at some point since the Effective From date.</p> <p>GK SPID has not been Tradable or TDISC continuously since the Effective From date.</p> <p>GL SPID must be continuously vacant from the Effective From date.</p> <p>GM Vacancy Admin Date of Evidence too early compared to the transaction date.</p> <p>GN Sender has transferred SPID since the Effective From date, or SPID transfer is pending.</p> <p>GO SPID must be continuously vacant from the Effective From date.</p> <p>GP SPID already has an existing Open Vacancy Application.</p> <p>GQ Vacancy Admin details do not match any opened T034.0 Vacancy Scheme Application.</p> <p>GR Vacancy Admin application has been previously closed.</p> <p>GS Vacancy Admin Grace Period has not yet elapsed (LP not yet notified).</p> <p>GT Vacancy Admin application rejected due to late T034.4.</p> <p>GU Date of Evidence must be in the past.</p> <p>GV SPID must not be New, Partial or REJ.</p> <p>GW SPID must be New, Partial or REJ.</p> <p>GX SS SPID must be connected via the WS SPID as the WS SPID is New, Partial or REJ.</p> <p>GY WS SPID must be (potentially) chargeable on given connection date.</p> <p>GZ SS SPID must be (potentially) chargeable on given date.</p> <p>HA Meter Read date must be greater than or equal to "2007-04-01".</p> <p>HB SPID has never been declared Unmeasurable or there are no Unmeasurable Service Elements active on or after the Effective From date.</p> <p>HC Meter cannot be swapped with itself.</p> <p>HD Meter Number of Digits cannot be changed.</p> <p>HE Meter Read digit count must be the same as the Meter digit count.</p> <p>HF For Future Use.</p> <p>HG For Future Use.</p> <p>HH For Future Use.</p> <p>HI For Future Use.</p> <p>HJ For Future Use.</p> <p>HK Return To Sewer Allowance must be zero for a Meter Treatment of Private Effluent or Tankered Effluent.</p> <p>HL Chargeable Meter Size must be zero for Meters with a Meter Treatment of; Private Water, Private Effluent, or Tankered Effluent.</p> <p>HM Meter Treatment must be the same for the Old and the New Meters.</p> <p>HN Return to Sewerage Allowance cannot be zero for Meters with Meter Treatment of SWWater, Private Water, or Logical Water that are associated to a DPID on the Effective From</p> |
|--|-------------------------------------------------------------------------------------------------------------------------------------------------------------------------------------------------------------------------------------------------------------------------------------------------------------------------------------------------------------------------------------------------------------------------------------------------------------------------------------------------------------------------------------------------------------------------------------------------------------------------------------------------------------------------------------------------------------------------------------------------------------------------------------------------------------------------------------------------------------------------------------------------------------------------------------------------------------------------------------------------------------------------------------------------------------------------------------------------------------------------------------------------------------------------------------------------------------------------------------------------------------------------------------------------------------------------------------------------------------------------------------------------------------------------------------------------------------------------------------------------------------------------------------------------------------------------------------------------------------------------------------------------------------------------------------------------------------------------------------------------------------------------------------------------------------------------------------------------------------------------------------------------------------------------------------------------------------------------------------------------------------------------------------------------------------------------------------------------------------------------------------------------------------------------------------------------------------------------------------------------------------------------------------------------------------------------------------------------------------------------------------------------------------------------------------------------------------------------------------------------------------------------------------------------------------------------------------------------------------------------------------------------------------------------------------------------------------------------------------------------------------------------------------------------------------------------------------------------------------------------------------------------------------------------------------------------------------------------------------------------------------------------------------------------------------------------------------------------------------------------------------------------------------------------------------------------------------------------------------------------------------------------------------------------------------------------------------------------------------------------------------------------------------------------------------------------------------------------------------------------------------------------------------------------------------------------------------------------------------------------------------------------------------------------------------------------------------------------------------------------------------------------------------------------------------------------------------------------------------------------------------------------------------------------------------------------------------------------------------------------------------------------------------------------------------------------------------------------------------------------------------------------------------------------------------------------------------------------------------------------------------------------------------------------------------------------------------------------------------------------------------------------------------------------------------------------------------------------------------------------------------------------|

| |
|------------------------------------------------------------------------------------------------------------------------------------------------------------------------------------------------------------------------------------------------------------------------------------------------------------------------------------------------------------------------------------------------------------------------------------------------------------------------------------------------------------------------------------------------------------------------------------------------------------------------------------------------------------------------------------------------------------------------------------------------------------------------------------------------------------------------------------------------------------------------------------------------------------------------------------------------------------------------------------------------------------------------------------------------------------------------------------------------------------------------------------------------------------------------------------------------------------------------------------------------------------------------------------------------------------------------------------------------------------------------------------------------------------------------------------------------------------------------------------------------------------------------------------------------------------------------------------------------------------------------------------------------------------------------------------------------------------------------------------------------------------------------------------------------------------------------------------------------------------------------------------------------------------------------------------------------------------------------------------------------------------------------------------------------------------------------------------------------------------------------------------------------------------------------------------------------------------------------------------------------------------------------------------------------------------------------------------------------------------------------------------------------------------------------------------------------------------------------------------------------------------------------------------------------------------------------------------------------------------------------------------------------------------------------------------------------------------------------------------------------------------------------------------------------------------------------------------------------------------------------------------------------------------------------------------------------------------------------------------------------------------------------------------------------------------------------------------------------------------------------------------------------------------------------------------------------------------------------------------------------------------------------------------------------------------------------------------------------------------------------------------------------------------------------------------------------------------------------------------------------------------------------------------------------------------------------------------------------------------------------------------------------------------------------------------------------------------------------------------------------------------------------------------------------------------------------------------------------------------------------------------------------------------------------------------------------------------------------------------------------------------------------------------------------------------------------------------------------------------------------------------------------------------------------------------------------------------------------------------------------------------------------------------------------------------------------------------------------------------------------------------------------------------------------------------------------------------------------------------------------------------------------------------------------------------------------------------------------------------------------------------------------------------------------------------------|
| <p>date.</p> <p>HO WS SPID must be associated with a Market Meter.</p> <p>HP SPID must be a SS SPID and must have an associated WS SPID.</p> <p>HQ WS SPID Transfer Meter Reads can only be sent by the Incoming LP.</p> <p>HR Sender must be the current LP.</p> <p>HS SS SPID of the DPID must be associated with the WS SPID of the Meter.</p> <p>HT MDVol value on the given Effective Date has already been set for the DPID-Meter Association.</p> <p>HU Return to Sewer should be greater than zero continuously from the Effective From Date.</p> <p>HV DPID has active meter associations.</p> <p>HW Sewerage Chargeable Meter Size must be zero for Private Effluent Meters and Tankered Effluent Meters.</p> <p>HX For Future Use.</p> <p>HY Meter Treatment of the Subtraction Meter must be the same as that of the Main Meter.</p> <p>HZ Meter Read rejected; the LP for the associated WS SPID should provide the Transfer read.</p> <p>IA For Future Use.</p> <p>IB Meter has previously been made active.</p> <p>IC Meter Network; The Sub SPID should not be the same as the Main SPID.</p> <p>ID For Future Use.</p> <p>IE MID Already Exists in the CMA CS.</p> <p>IF Meter is not associated to the provided SPID.</p> <p>IG Meter should have a Meter Treatment of SW Water or Private Water.</p> <p>IH Meter should have at least one meter reading.</p> <p>II Meter Network, Sub Meter is non-domestic but the Sub SPID Is not provided OR the Sub Meter is domestic yet a Sub SPID is provided.</p> <p>IJ Meter Network Association is already active for the requested period.</p> <p>IK Meter Network Association is already inactive for the requested period.</p> <p>IL Meter Network; Sub Meter can only be actively associated to one Main Meter at any given time.</p> <p>IM Meter Network Association does not exist between the Main Meter and the Sub Meter.</p> <p>IN Meter Network Activation date should be prior to the earlier of the Main & Sub End Dates.</p> <p>IO Meter Network Activation date should be after the later of the Main & Sub Start Dates.</p> <p>IP Meter is part of a Meter Network that is active at a date on or after the Final Read Date.</p> <p>IQ WS SPID or Associated SS SPID has more than one Unmeasurable on a given day on or after the Effective From Date.</p> <p>IR Metered period must not overlap with an Unmeasured period.</p> <p>IS SPID has been allocated via the Gap Site allocation process and cannot be rejected.</p> <p>IT Meter S Read Reason Code must be provided.</p> <p>IU Meter S Read Remedial Work Indicator must be provided and set to True.</p> <p>IV Percentage Exemption should only be provided if the Customer Exemption Flag is provided and is set to True.</p> <p>IW Percent Exemption value must be 50% or 100%. .</p> <p>IX Sender Org ID does not exist in CMA CS.</p> <p>IY Associated WS SPID must not be Tradable or TDISC.</p> <p>IZ Effective From Date must not pre-date a previous change on an Associated SPID.</p> <p>JA Meter IDs and DPIDs cannot include control characters.</p> <p>JB Meter S Read Reason Code and S Read Remedial Work Indicator should only be provided for S reads.</p> <p>JC SPID SAA Ref or SAA Ref Absence Code must be provided.</p> <p>JD SPID UPRN or the UPRN Absence Code must be provided.</p> <p>JE SPID SAA Ref and/or UPRN already exists in the CS against a SPID that is New, Partial, Tradable, TDISC, or Rejected.</p> <p>JF SPID SAA Ref and/or UPRN should match the existing value in the CMA CS .</p> <p>JG SPID SAA Ref is duplicated in SAA data - more information required.</p> <p>JH SPID SAA Ref and UPRN data must be provided.</p> <p>JI RA; Data Item must be specified.</p> <p>JJ RA; Value must be specified.</p> <p>JK RA; EFD must be specified.</p> <p>JL RA; DPID must be specified.</p> <p>JM RA; The specified Data Item is not updateable. Please check that the Data Item is valid for the selected template.</p> <p>JN RA; the provided Value must be consistent with the specified Data Item.</p> <p>JO RA; invalid date provided.</p> <p>JP RA; Physical Meter Size must be between 1 and 9999.</p> <p>JQ RA; record must be for a SS SPID.</p> <p>JR RA; D2024_Unmeasurable is incompatible with existing Metered Service Elements - cannot be effective during a Water Metered Period.</p> <p>JS RA; D2024_Unmeasurable is incompatible with existing Metered Service Elements - cannot be effective during a Foul Water Metered Period (with RTS > 0).</p> <p>JT RA; Effective From date must be after database entry.</p> <p>JU RA; Existing Meter Read Date must be specified.</p> |
|------------------------------------------------------------------------------------------------------------------------------------------------------------------------------------------------------------------------------------------------------------------------------------------------------------------------------------------------------------------------------------------------------------------------------------------------------------------------------------------------------------------------------------------------------------------------------------------------------------------------------------------------------------------------------------------------------------------------------------------------------------------------------------------------------------------------------------------------------------------------------------------------------------------------------------------------------------------------------------------------------------------------------------------------------------------------------------------------------------------------------------------------------------------------------------------------------------------------------------------------------------------------------------------------------------------------------------------------------------------------------------------------------------------------------------------------------------------------------------------------------------------------------------------------------------------------------------------------------------------------------------------------------------------------------------------------------------------------------------------------------------------------------------------------------------------------------------------------------------------------------------------------------------------------------------------------------------------------------------------------------------------------------------------------------------------------------------------------------------------------------------------------------------------------------------------------------------------------------------------------------------------------------------------------------------------------------------------------------------------------------------------------------------------------------------------------------------------------------------------------------------------------------------------------------------------------------------------------------------------------------------------------------------------------------------------------------------------------------------------------------------------------------------------------------------------------------------------------------------------------------------------------------------------------------------------------------------------------------------------------------------------------------------------------------------------------------------------------------------------------------------------------------------------------------------------------------------------------------------------------------------------------------------------------------------------------------------------------------------------------------------------------------------------------------------------------------------------------------------------------------------------------------------------------------------------------------------------------------------------------------------------------------------------------------------------------------------------------------------------------------------------------------------------------------------------------------------------------------------------------------------------------------------------------------------------------------------------------------------------------------------------------------------------------------------------------------------------------------------------------------------------------------------------------------------------------------------------------------------------------------------------------------------------------------------------------------------------------------------------------------------------------------------------------------------------------------------------------------------------------------------------------------------------------------------------------------------------------------------------------------------------------------------------------------------------|

| | |
|--------|-----------------------------------------------------------------------------------------------------------------------------------------------------------------------------------------------------------------------------------------------------------------------------------------------------------------------------------------------------------------------------------------------------------------------------------------------------------------------------------------------------------------------------------------------------------------------------------------------------------------------------------------------------------------------------------------------------------------------------------------------------------------------------------------------------------------------------------------------------------------------------------------------------------------------------------------------------------------------------------------------------------------------------------------------------------------------------------------------------------------------------------------------------------------------------------------------------------------------------------------------------------------------------------------------------------------------------------------------------------------------------------------------------------------------------------------------------------------------------------------------------------------------------------------------------------------------------------------------------------------------------------------------------------------------------------------------------------------------------------------------------------------------------------------------------------------------------------------------------------------------------------------------------------------------------------------------------------------------------------------------------------|
| | <p>JV RA; at least one updatable field needs to be provided.</p> <p>JW I and F reads for Pseudo Meters must be zero.</p> <p>JX RA; invalid Meter Read value provided.</p> <p>JY RA; No Meter Read exists for specified existing read date.</p> <p>JZ RA; the specified Meter Read Type is not updatable via the RA Process.</p> <p>KA RA; this Read Type cannot be deleted.</p> <p>KB RA; Meter Read date must be before a different meter reading.</p> <p>KC RA; Meter Read must be lower than subsequent meter reading.</p> <p>KD RA; Meter Read must be after SPID Connection Date.</p> <p>KE RA; the Final Meter Read should be the last meter reading.</p> <p>KF RA; Meter Read date must be after different meter reading.</p> <p>KG RA; Meter Read must be greater than previous meter reading.</p> <p>KH RA; the Final read must be before the Disconnection/Deregistration Date.</p> <p>KI RA; the Opening Meter Read should be the first meter reading.</p> <p>KJ RA; Meter is not in a SWAP chain.</p> <p>KK RA; the End Meter Read should be the last meter reading.</p> <p>KL RA; SPID updates are only allowed to be made by the owning LP between the specified date ranges.</p> <p>KM RA; the incoming LP is only allowed to amend T and S Reads.</p> <p>KN RA; invalid Rollover value provided.</p> <p>KO SPID is currently Deregistered and so it cannot be Disconnected.</p> <p>KP SPID is currently Disconnected and so it cannot be Deregistered.</p> <p>KQ Rateable Values must be whole numbers, or must be selected from the allowed default values.</p> <p>KR Meter must be Pending for the read to be accepted.</p> <p>KS Meter must be Active for the read to be accepted.</p> <p>XA Licensed Provider rejects registration for a new SPID.</p> |
| source | <pre><xs:simpleType name="ReturnCodeType"> <xs:annotation> <xs:documentation> AASender must be the valid Licensed Provider. ABSPID must be supplied in the transaction. AC SPID must exist in the CMA CS. AD Meter Read can only be submitted as a re-read if it is an exact duplicate of a rejected Read. AESPID status must be Tradable. AF SPID status must be New. AG Data Items must be submitted for the WS SPID. AH Meter Read Y must be greater than or equal to Meter Read X. AI Connection Date must be in the past. AJ Meter S Read Remedial Work Indicator must be provided and set to False. AKRegistration Start Date must be within the permitted window. AL Licensed Provider nominated by Scottish Water has rejected the registration of the new SPID. AM Transfer Cancellation must be within the Cancellation Window. AN Meter S Read Reason Code is not valid for the provided SPID. AO Taps/Troughs must be qualified as Farm or Croft. APMeter must be Pending or Active. AQ SPID transfer to other Applicant already in progress. AR SPID already registered to Applicant, or transfer to Applicant already pending. ASCancellation request not applicable to this Licensed Provider. ATMeter Read Rejected: Read type inappropriate. AU SPID Disconnection date must be today or in the past. AVSPID status must be Partial or Tradable. AW MID must start with the Org ID for the submitting Trading Party. AXEffective From date predates current registration start date. AYMeter being Swapped must be Active. AZMeter can only be added to a WS SPID. BAMID should only contain numeric values after the OrgId. BBTransaction not appropriate for Pseudo Meters. BC Meter not associated to a SPID.</pre> |

| | |
|------------|--------------------------------------------------------------------------------------------------------------------------------------------------------------------------------|
| BD | Transaction rejected as MID number falls into a range that has been archived. Resend message with a new MID. |
| BEMeter | Read must be within its capacity limit. |
| BFMeter | Read for this date already exists. |
| BG | Licensed Provider not registered to SPID. |
| BH | Meter Read must be on or below its daily usage limit. |
| BI | Meter Read date for the New Meter must be the same or after the Old Meter Read date. |
| BL | Meter Read must be on or above the daily usage minimum. |
| BN | Meter Read must create a positive meter advance, not a small negative advance. |
| BVMeter | Read must create a positive meter advance, not a large negative advance. |
| BZ | Meter Read must create a positive advance, not a zero advance. |
| DA | RA; Rollover Indicator must not be present on an I or an F read. |
| DB | RA; Logical Water meters must either have a zero value I read or a zero value F read. |
| DC | Transaction must be for a WS SPID. |
| DD | Service Category already exists for this connection. |
| DE | Old and New Meters incompatible for meter swap. Old Meter is not a domestic meter. |
| DEffective | From date predates previous change. |
| DG | MIDs submitted to the HVI are not allowed within the LVI MID range (1000000000 to 1999999999). Resend message with a new MID. |
| DH | Sender must be Licensed Provider on Meter Read Date. |
| DI | SPID has passed the switching limit. |
| DJ | Transaction must contain: Sender, Recipient, Timestamp, SPID. |
| DK | Effective From Date cannot be in the future. |
| DL | Sender must be wholesaler. |
| DM | DPID already exists. |
| DN | DPID is discontinued. |
| DO | DPID must be associated to the associated Sewerage SPID. |
| DP | DPID not associated with a Meter. |
| DQ | DPID already discontinued. |
| DR | DPID does not exist in the CMA CS. |
| DS | Sender must be the Licensed Provider for the SPID continuously from the Meter Read Date to the HVI Received at Date. |
| DTA | Main Meter must not previously have been a Sub Meter on a Meter Network for the same SPID and a Sub Meter must not have been a Main Meter on a Meter Network on the same SPID. |
| DU | For Future Use. |
| DV | Customer Name must conform to the required format. |
| DW | For Future Use. |
| DX | SS SPID is paired with a WS SPID with a status of Tradable or TDISC. |
| DY | Meter Is a Pseudo Meter. |
| DZ | SPID or Registration Start Date is not valid. |
| EAGIS | X, Y coordinates must be in Scotland. |
| EB | Comments field must be populated. The comment must be between 1 and 255 characters long. |
| EC | GIS X, Y data Incomplete. |
| ED | SPID must be a SS SPID. |
| EE | Rollover Indicator not consistent with CMA CS determination. |
| EF | Rollover Indicator required. CMA CS unable to determine the rollover status. |
| EG | SPID cannot be allocated. There are no Licensed Providers available for Gap Site allocation. |
| EH | For Future Use. |
| EI | Rollover Indicator must not be present on an O or an I read. |

EJ SPID status must not be; PDISC or DREG.
 EK For Future Use.
 EL For Future Use.
 EM For Future Use.
 EN SPID status is already TDISC.
 EO SPID status is must be TDISC.
 EP SPID must not be subject to a pending transfer for TDISC to proceed.
 EQ SPID must not be New or Partial.
 ER SPID must be New or Partial.
 ES For Future Use.
 ET SPID must not be; PDISC, DREG or REJ.
 EU SPID status must not be Unmeasurable.
 EV For Future Use.
 EW For Future Use.
 EX Licensed Provider Org ID does not match Sender Org ID.
 EY Meter does not exist in the CMA CS.
 EZ For Future Use.
 FA Meter already exists in the CMA CS.
 FB Transaction must include a Meter ID.
 FC Transaction must include a Meter Make.
 FD Transaction must include a Manufacturers Meter Serial Number.
 FE For Future Use.
 FF Meter Read Frequency must be N.
 FG Meter Chargeable Size must be 20mm.
 FH Meter is attached to a SPID and a SPID must be provided.
 FI For Future Use.
 FJ SPID status must be Tradable or TDISC.
 FK SPID should not be included for a Non-Market Meter.
 FL For Future Use.
 FM Meter: Both Old and New Meters must be included in the transaction.
 FN Meter: Old and/or New Meter must exist in the CMA CS.
 FO Old Meter read type must be E and/or New Meter Read type must be O, or New Meter has a previous reading.
 FP Meter must be Active.
 FQ Meter: Old and/or New Meter cannot be a Pseudo meter.
 FR Meter: Old and New Meters must contain same chargeable size and RTS.
 FS Meter: New Meter is in a Meter Network and cannot be swapped.
 FT Meter: New Meter must be Active or Pending.
 FU Sender must exist in CMA CS.
 FV Meter Read date must be later than the Effective To date of Unmeasurable Service Elements associated with the SPID.
 FW Meter Read must not be a duplicate I or a duplicate F read.
 FX Meter Read must be on a date after the last meter reading.
 FY For Future Use.
 FZ For Future Use.
 GA SPID status must be Partial.
 GB Meter Effective From date and/or Metered Building Water Flag values must be different to the current values in the CMA CS.
 GC Meter Effective From date must be on or after 1 April 2011.
 GD For Future Use.
 GE Data Items that are required have not been provided for this Meter Treatment type.
 GF SPID is New or Partial and must be Deregistered.
 GG Meter(s) at the SPID must be Discontinued.
 GH DPID(s) at the SPID must be Discontinued.
 GI Meter Read Date must be today or in the past.
 GJ SS SPID has been associated to a Tradable WS SPID at some point since the Effective From date.

| | |
|------|-----------------------------------------------------------------------------------------------------------------------------------------------------------------------------------|
| GK | SPID has not been Tradable or TDISC continuously since the Effective From date. |
| | GLSPID must be continuously vacant from the Effective From date. |
| GM | Vacancy Admin Date of Evidence too early compared to the transaction date. |
| GN | Sender has transferred SPID since the Effective From date, or SPID transfer is pending. |
| GO | SPID must be continuously vacant from the Effective From date. |
| GP | SPID already has an existing Open Vacancy Application. |
| GQ | Vacancy Admin details do not match any opened T034.0 Vacancy Scheme Application. |
| GR | Vacancy Admin application has been previously closed. |
| GS | Vacancy Admin Grace Period has not yet elapsed (LP not yet notified). |
| GT | Vacancy Admin application rejected due to late T034.4. |
| GU | Date of Evidence must be in the past. |
| GV | SPID must not be New, Partial or REJ. |
| GW | SPID must be New, Partial or REJ. |
| GX | SS SPID must be connected via the WS SPID as the WS SPID is New, Partial or REJ. |
| GY | WS SPID must be (potentially) chargeable on given connection date. |
| GZ | SS SPID must be (potentially) chargeable on given date. |
| HA | Meter Read date must be greater than or equal to "2007-04-01". |
| HB | SPID has never been declared Unmeasurable or there are no Unmeasurable Service Elements active on or after the Effective From date. |
| HC | Meter cannot be swapped with itself. |
| HD | Meter Number of Digits cannot be changed. |
| HE | Meter Read digit count must be the same as the Meter digit count. |
| HFF | For Future Use. |
| HG | For Future Use. |
| HH | For Future Use. |
| HI | For Future Use. |
| HJ | For Future Use. |
| HK | Return To Sewer Allowance must be zero for a Meter Treatment of Private Effluent or Tankered Effluent. |
| HL | Chargeable Meter Size must be zero for Meters with a Meter Treatment of; Private Water, Private Effluent, or Tankered Effluent. |
| HM | Meter Treatment must be the same for the Old and the New Meters. |
| HN | Return to Sewerage Allowance cannot be zero for Meters with Meter Treatment of SWWater, Private Water, or Logical Water that are associated to a DPID on the Effective From date. |
| HO | WS SPID must be associated with a Market Meter. |
| HP | SPID must be a SS SPID and must have an associated WS SPID. |
| HQ | WS SPID Transfer Meter Reads can only be sent by the Incoming LP. |
| HR | Sender must be the current LP. |
| HS | SS SPID of the DPID must be associated with the WS SPID of the Meter. |
| HTMD | Vol value on the given Effective Date has already been set for the DPID-Meter Association. |
| HU | Return to Sewer should be greater than zero continuously from the Effective From Date. |
| HV | DPID has active meter associations. |
| HW | Sewerage Chargeable Meter Size must be zero for Private Effluent Meters and Tankered Effluent Meters. |

HX For Future Use.

HY Meter Treatment of the Subtraction Meter must be the same as that of the Main Meter.

HZ Meter Read rejected; the LP for the associated WS SPID should provide the Transfer read.

IA For Future Use.

IB Meter has previously been made active.

IC Meter Network; The Sub SPID should not be the same as the Main SPID.

ID For Future Use.

IE MID Already Exists in the CMA CS.

IF Meter is not associated to the provided SPID.

IG Meter should have a Meter Treatment of SW Water or Private Water.

IH Meter should have at least one meter reading.

II Meter Network, Sub Meter is non-domestic but the Sub SPID Is not provided OR the Sub Meter is domestic yet a Sub SPID is provided.

IJ Meter Network Association is already active for the requested period.

IK Meter Network Association is already inactive for the requested period.

IL Meter Network; Sub Meter can only be actively associated to one Main Meter at any given time.

IM Meter Network Association does not exist between the Main Meter and the Sub Meter.

IN Meter Network Activation date should be prior to the earlier of the Main & Sub End Dates.

IO Meter Network Activation date should be after the later of the Main & Sub Start Dates.

IP Meter is part of a Meter Network that is active at a date on or after the Final Read Date.

IQ WS SPID or Associated SS SPID has more than one Unmeasurable on a given day on or after the Effective From Date.

IR Metered period must not overlap with an Unmeasured period.

IS SPID has been allocated via the Gap Site allocation process and cannot be rejected.

IT Meter S Read Reason Code must be provided.

IU Meter S Read Remedial Work Indicator must be provided and set to True.

IV Percentage Exemption should only be provided if the Customer Exemption Flag is provided and is set to True.

IW Percent Exemption value must be 50% or 100%.

IX Sender Org ID does not exist in CMA CS.

IY Associated WS SPID must not be Tradable or TDISC.

IZ Effective From Date must not pre-date a previous change on an Associated SPID.

JA Meter IDs and DPIDs cannot include control characters.

JB Meter S Read Reason Code and S Read Remedial Work Indicator should only be provided for S reads.

JC SPID SAA Ref or SAA Ref Absence Code must be provided.

JD SPID UPRN or the UPRN Absence Code must be provided.

JE SPID SAA Ref and/or UPRN already exists in the CS against a SPID that is New, Partial, Tradable, TDISC, or Rejected.

JF SPID SAA Ref and/or UPRN should match the existing value in the CMA CS.

JG SPID SAA Ref is duplicated in SAA data - more information required.

JH SPID SAA Ref and UPRN data must be provided.

JI RA; Data Item must be specified.

JJ RA; Value must be specified.

JK RA; EFD must be specified.

JL RA; DPID must be specified.

JMRA; The specified Data Item is not updateable. Please check that the Data Item is valid for the selected template.

JN RA; the provided Value must be consistent with the specified Data Item.

JORA; invalid date provided.
 JP RA; Physical Meter Size must be between 1 and 9999.
 JQRA; record must be for a SS SPID.
 JR RA; D2024_Unmeasurable is incompatible with existing Metered Service Elements - cannot be effective during a Water Metered Period.
 JS RA; D2024_Unmeasurable is incompatible with existing Metered Service Elements - cannot be effective during a Foul Water Metered Period (with RTS > 0).

JT RA; Effective From date must be after database entry.
 JU RA; Existing Meter Read Date must be specified.
 JV RA; at least one updatable field needs to be provided.
 JW I and F reads for Pseudo Meters must be zero.
 JX RA; invalid Meter Read value provided.
 JY RA; No Meter Read exists for specified existing read date.
 JZ RA; the specified Meter Read Type is not updatable via the RA Process.
 KARA; this Read Type cannot be deleted.
 KBRA; Meter Read date must be before a different meter reading.
 KC RA; Meter Read must be lower than subsequent meter reading.
 KD RA; Meter Read must be after SPID Connection Date.
 KERA; the Final Meter Read should be the last meter reading.
 KFRA; Meter Read date must be after different meter reading.
 KG RA; Meter Read must be greater than previous meter reading.
 KH RA; the Final read must be before the Disconnection/Deregistration Date.
 KI RA; the Opening Meter Read should be the first meter reading.
 KJ RA; Meter is not in a SWAP chain.
 KKRA; the End Meter Read should be the last meter reading.
 KL RA; SPID updates are only allowed to be made by the owning LP between the specified date ranges.
 KM RA; the incoming LP is only allowed to amend T and S Reads.
 KN RA; invalid Rollover value provided.
 KO SPID is currently Deregistered and so it cannot be Disconnected.
 KPSPID is currently Disconnected and so it cannot be Deregistered.
 KQ Rateable Values must be whole numbers, or must be selected from the allowed default values.
 KR Meter must be Pending for the read to be accepted.
 KSMeter must be Active for the read to be accepted.
 XALicensed Provider rejects registration for a new SPID.

```

</xs:documentation>
</xs:annotation>
<xs:restriction base="xs:string">
  <xs:enumeration value="AA"/>
  <xs:enumeration value="AB"/>
  <xs:enumeration value="AC"/>
  <xs:enumeration value="AD"/>
  <xs:enumeration value="AE"/>
  <xs:enumeration value="AF"/>
  <xs:enumeration value="AG"/>
  <xs:enumeration value="AH"/>
  <xs:enumeration value="AI"/>
  <xs:enumeration value="AJ"/>
  <xs:enumeration value="AK"/>
  <xs:enumeration value="AL"/>
  <xs:enumeration value="AM"/>
  <xs:enumeration value="AN"/>
  <xs:enumeration value="AO"/>
  <xs:enumeration value="AP"/>
  <xs:enumeration value="AQ"/>
  <xs:enumeration value="AR"/>

```



```
<xs:enumeration value="AS"/>
<xs:enumeration value="AT"/>
<xs:enumeration value="AU"/>
<xs:enumeration value="AV"/>
<xs:enumeration value="AW"/>
<xs:enumeration value="AX"/>
<xs:enumeration value="AY"/>
<xs:enumeration value="AZ"/>
<xs:enumeration value="BA"/>
<xs:enumeration value="BB"/>
<xs:enumeration value="BC"/>
<xs:enumeration value="BD"/>
<xs:enumeration value="BE"/>
<xs:enumeration value="BF"/>
<xs:enumeration value="BG"/>
<xs:enumeration value="BH"/>
<xs:enumeration value="BI"/>
<xs:enumeration value="BL"/>
<xs:enumeration value="BN"/>
<xs:enumeration value="BV"/>
<xs:enumeration value="BZ"/>
<xs:enumeration value="OK"/>
<xs:enumeration value="DA"/>
<xs:enumeration value="DB"/>
<xs:enumeration value="DC"/>
<xs:enumeration value="DD"/>
<xs:enumeration value="DE"/>
<xs:enumeration value="DF"/>
<xs:enumeration value="DG"/>
<xs:enumeration value="DH"/>
<xs:enumeration value="DI"/>
<xs:enumeration value="DJ"/>
<xs:enumeration value="DK"/>
<xs:enumeration value="DL"/>
<xs:enumeration value="DM"/>
<xs:enumeration value="DN"/>
<xs:enumeration value="DO"/>
<xs:enumeration value="DP"/>
<xs:enumeration value="DQ"/>
<xs:enumeration value="DR"/>
<xs:enumeration value="DS"/>
<xs:enumeration value="DT"/>
<xs:enumeration value="DU"/>
<xs:enumeration value="DV"/>
<xs:enumeration value="DW"/>
<xs:enumeration value="DX"/>
<xs:enumeration value="DY"/>
<xs:enumeration value="DZ"/>
<xs:enumeration value="EA"/>
<xs:enumeration value="EB"/>
<xs:enumeration value="EC"/>
<xs:enumeration value="ED"/>
<xs:enumeration value="EE"/>
<xs:enumeration value="EF"/>
<xs:enumeration value="EG"/>
<xs:enumeration value="EH"/>
<xs:enumeration value="EI"/>
<xs:enumeration value="EJ"/>
<xs:enumeration value="EK"/>
```

```
<xs:enumeration value="EL"/>
<xs:enumeration value="EM"/>
<xs:enumeration value="EN"/>
<xs:enumeration value="EO"/>
<xs:enumeration value="EP"/>
<xs:enumeration value="EQ"/>
<xs:enumeration value="ER"/>
<xs:enumeration value="ES"/>
<xs:enumeration value="ET"/>
<xs:enumeration value="EU"/>
<xs:enumeration value="EV"/>
<xs:enumeration value="EW"/>
<xs:enumeration value="EX"/>
<xs:enumeration value="EY"/>
<xs:enumeration value="EZ"/>
<xs:enumeration value="FA"/>
<xs:enumeration value="FB"/>
<xs:enumeration value="FC"/>
<xs:enumeration value="FD"/>
<xs:enumeration value="FE"/>
<xs:enumeration value="FF"/>
<xs:enumeration value="FG"/>
<xs:enumeration value="FH"/>
<xs:enumeration value="FI"/>
<xs:enumeration value="FJ"/>
<xs:enumeration value="FK"/>
<xs:enumeration value="FL"/>
<xs:enumeration value="FM"/>
<xs:enumeration value="FN"/>
<xs:enumeration value="FO"/>
<xs:enumeration value="FP"/>
<xs:enumeration value="FQ"/>
<xs:enumeration value="FR"/>
<xs:enumeration value="FS"/>
<xs:enumeration value="FT"/>
<xs:enumeration value="FU"/>
<xs:enumeration value="FV"/>
<xs:enumeration value="FW"/>
<xs:enumeration value="FX"/>
<xs:enumeration value="FY"/>
<xs:enumeration value="FZ"/>
<xs:enumeration value="GA"/>
<xs:enumeration value="GB"/>
<xs:enumeration value="GC"/>
<xs:enumeration value="GD"/>
<xs:enumeration value="GE"/>
<xs:enumeration value="GF"/>
<xs:enumeration value="GG"/>
<xs:enumeration value="GH"/>
<xs:enumeration value="GI"/>
<xs:enumeration value="GJ"/>
<xs:enumeration value="GK"/>
<xs:enumeration value="GL"/>
<xs:enumeration value="GM"/>
<xs:enumeration value="GN"/>
<xs:enumeration value="GO"/>
<xs:enumeration value="GP"/>
<xs:enumeration value="GQ"/>
<xs:enumeration value="GR"/>
```

```
<xs:enumeration value="GS"/>
<xs:enumeration value="GT"/>
<xs:enumeration value="GU"/>
<xs:enumeration value="GV"/>
<xs:enumeration value="GW"/>
<xs:enumeration value="GX"/>
<xs:enumeration value="GY"/>
<xs:enumeration value="GZ"/>
<xs:enumeration value="HA"/>
<xs:enumeration value="HB"/>
<xs:enumeration value="HC"/>
<xs:enumeration value="HD"/>
<xs:enumeration value="HE"/>
<xs:enumeration value="HF"/>
<xs:enumeration value="HG"/>
<xs:enumeration value="HH"/>
<xs:enumeration value="HI"/>
<xs:enumeration value="HJ"/>
<xs:enumeration value="HK"/>
<xs:enumeration value="HL"/>
<xs:enumeration value="HM"/>
<xs:enumeration value="HN"/>
<xs:enumeration value="HO"/>
<xs:enumeration value="HP"/>
<xs:enumeration value="HQ"/>
<xs:enumeration value="HR"/>
<xs:enumeration value="HS"/>
<xs:enumeration value="HT"/>
<xs:enumeration value="HU"/>
<xs:enumeration value="HV"/>
<xs:enumeration value="HW"/>
<xs:enumeration value="HX"/>
<xs:enumeration value="HY"/>
<xs:enumeration value="HZ"/>
<xs:enumeration value="IA"/>
<xs:enumeration value="IB"/>
<xs:enumeration value="IC"/>
<xs:enumeration value="ID"/>
<xs:enumeration value="IE"/>
<xs:enumeration value="IF"/>
<xs:enumeration value="IG"/>
<xs:enumeration value="IH"/>
<xs:enumeration value="II"/>
<xs:enumeration value="IJ"/>
<xs:enumeration value="IK"/>
<xs:enumeration value="IL"/>
<xs:enumeration value="IM"/>
<xs:enumeration value="IN"/>
<xs:enumeration value="IO"/>
<xs:enumeration value="IP"/>
<xs:enumeration value="IQ"/>
<xs:enumeration value="IR"/>
<xs:enumeration value="IS"/>
<xs:enumeration value="IT"/>
<xs:enumeration value="IU"/>
<xs:enumeration value="IV"/>
<xs:enumeration value="IW"/>
<xs:enumeration value="IX"/>
<xs:enumeration value="IY"/>
```

```

<xs:enumeration value="IZ"/>
<xs:enumeration value="JA"/>
<xs:enumeration value="JB"/>
<xs:enumeration value="JC"/>
<xs:enumeration value="JD"/>
<xs:enumeration value="JE"/>
<xs:enumeration value="JF"/>
<xs:enumeration value="JG"/>
<xs:enumeration value="JH"/>
<xs:enumeration value="JI"/>
<xs:enumeration value="JJ"/>
<xs:enumeration value="JK"/>
<xs:enumeration value="JL"/>
<xs:enumeration value="JM"/>
<xs:enumeration value="JN"/>
<xs:enumeration value="JO"/>
<xs:enumeration value="JP"/>
<xs:enumeration value="JQ"/>
<xs:enumeration value="JR"/>
<xs:enumeration value="JS"/>
<xs:enumeration value="JT"/>
<xs:enumeration value="JU"/>
<xs:enumeration value="JV"/>
<xs:enumeration value="JW"/>
<xs:enumeration value="JX"/>
<xs:enumeration value="JY"/>
<xs:enumeration value="JZ"/>
<xs:enumeration value="KA"/>
<xs:enumeration value="KB"/>
<xs:enumeration value="KC"/>
<xs:enumeration value="KD"/>
<xs:enumeration value="KE"/>
<xs:enumeration value="KF"/>
<xs:enumeration value="KG"/>
<xs:enumeration value="KH"/>
<xs:enumeration value="KI"/>
<xs:enumeration value="KJ"/>
<xs:enumeration value="KK"/>
<xs:enumeration value="KL"/>
<xs:enumeration value="KM"/>
<xs:enumeration value="KN"/>
<xs:enumeration value="KO"/>
<xs:enumeration value="KP"/>
<xs:enumeration value="KQ"/>
<xs:enumeration value="KR"/>
<xs:enumeration value="KS"/>
<xs:enumeration value="XA"/>
</xs:restriction>
</xs:simpleType>

```

simpleType **ServiceCategoryType**

| | |
|------------|-----------------------------------------------------------------------------------------|
| namespace | urn:bridgeall-com:cmaservice:data:v3 |
| type | restriction of xs:string |
| properties | base xs:string |
| used by | elements D2002_ServiceCategory_NewSPIDRequestType/D2002_ServiceCategory |

| facets | <table> <thead> <tr> <th>Kind</th> <th>Value</th> <th>annotation</th> </tr> </thead> <tbody> <tr> <td>enumeration</td> <td>01</td> <td></td> </tr> <tr> <td>enumeration</td> <td>02</td> <td></td> </tr> </tbody> </table> | Kind | Value | annotation | enumeration | 01 | | enumeration | 02 | |
|-------------|---------------------------------------------------------------------------------------------------------------------------------------------------------------------------------------------------------------------------------------------------------------------------------------------------------------------------------------------------------------------------------------------------------------------------------|------------|-------|------------|-------------|----|--|-------------|----|--|
| Kind | Value | annotation | | | | | | | | |
| enumeration | 01 | | | | | | | | | |
| enumeration | 02 | | | | | | | | | |
| annotation | documentation Enumeration of service categories 01 - Water 02 - Sewerage | | | | | | | | | |
| source | <pre> <xs:simpleType name="ServiceCategoryType"> <xs:annotation> <xs:documentation> Enumeration of service categories 01 - Water 02 - Sewerage </xs:documentation> </xs:annotation> <xs:restriction base="xs:string"> <xs:enumeration value="01"/> <xs:enumeration value="02"/> </xs:restriction> </xs:simpleType> </pre> | | | | | | | | | |

simpleType **SReadReasonCodeType**

| namespace | urn:bridgeall-com:cmaservice:data:v3 | | | | | | | | | | | | | | | | | | |
|-------------|--------------------------------------------------------------------------------------------------------------------------------------------------------------------------------------------------------------------------------------------------------------------------------------------------------------------------------------------------------------------------------------------------------------------------------------------------------------------------|------------|-------|------------|-------------|-----|--|-------------|-----|--|-------------|-----|--|-------------|-----|--|-------------|-----|--|
| type | restriction of xs:string | | | | | | | | | | | | | | | | | | |
| properties | base xs:string | | | | | | | | | | | | | | | | | | |
| used by | element D3028 SReadReasonCode | | | | | | | | | | | | | | | | | | |
| facets | <table> <thead> <tr> <th>Kind</th> <th>Value</th> <th>annotation</th> </tr> </thead> <tbody> <tr> <td>enumeration</td> <td>WMD</td> <td></td> </tr> <tr> <td>enumeration</td> <td>NMA</td> <td></td> </tr> <tr> <td>enumeration</td> <td>MNF</td> <td></td> </tr> <tr> <td>enumeration</td> <td>NSA</td> <td></td> </tr> <tr> <td>enumeration</td> <td>PLR</td> <td></td> </tr> </tbody> </table> | Kind | Value | annotation | enumeration | WMD | | enumeration | NMA | | enumeration | MNF | | enumeration | NSA | | enumeration | PLR | |
| Kind | Value | annotation | | | | | | | | | | | | | | | | | |
| enumeration | WMD | | | | | | | | | | | | | | | | | | |
| enumeration | NMA | | | | | | | | | | | | | | | | | | |
| enumeration | MNF | | | | | | | | | | | | | | | | | | |
| enumeration | NSA | | | | | | | | | | | | | | | | | | |
| enumeration | PLR | | | | | | | | | | | | | | | | | | |
| annotation | documentation S Read Reason Code WMD Wrong Meter Details NMA No Meter Access MNF Meter Not Found NSA No Site Access PLR PoLR Transfer | | | | | | | | | | | | | | | | | | |
| source | <pre> <xs:simpleType name="SReadReasonCodeType"> <xs:annotation> <xs:documentation> S Read Reason Code WMD Wrong Meter Details NMA No Meter Access MNF Meter Not Found NSA No Site Access PLR PoLR Transfer </xs:documentation> </xs:annotation> <xs:restriction base="xs:string"> <xs:enumeration value="WMD"/> </xs:restriction> </xs:simpleType> </pre> | | | | | | | | | | | | | | | | | | |

| | |
|--|-------------------------------------------------------------------------------------------------------------------------------------------------------------------------------------------------------------|
| | <pre> <xs:enumeration value="NMA"/> <xs:enumeration value="MNF"/> <xs:enumeration value="NSA"/> <xs:enumeration value="PLR"/> </xs:restriction> </xs:simpleType> </pre> |
|--|-------------------------------------------------------------------------------------------------------------------------------------------------------------------------------------------------------------|

simpleType string32

| namespace | urn:bridgeall-com:cmaservice:data:v3 | | | | | | | | | | | | |
|------------|----------------------------------------------------------------------------------------------------------------------------------------------------------------------------------------------------------------------------------------------------------------------------------------------|------------|-------|------------|-----------|---|--|-----------|----|--|---------|--------------|--|
| type | restriction of xs:string | | | | | | | | | | | | |
| properties | base xs:string | | | | | | | | | | | | |
| used by | elements D3001 MeterId D3013 MeterMake D3014 ManufacturerMeterSerialNr D3027 MainMeterId D6001 DPID | | | | | | | | | | | | |
| facets | <table border="1"> <thead> <tr> <th>Kind</th> <th>Value</th> <th>annotation</th> </tr> </thead> <tbody> <tr> <td>minLength</td> <td>1</td> <td></td> </tr> <tr> <td>maxLength</td> <td>32</td> <td></td> </tr> <tr> <td>pattern</td> <td>([^\t\n\r])*</td> <td></td> </tr> </tbody> </table> | Kind | Value | annotation | minLength | 1 | | maxLength | 32 | | pattern | ([^\t\n\r])* | |
| Kind | Value | annotation | | | | | | | | | | | |
| minLength | 1 | | | | | | | | | | | | |
| maxLength | 32 | | | | | | | | | | | | |
| pattern | ([^\t\n\r])* | | | | | | | | | | | | |
| source | <pre> <xs:simpleType name="string32"> <xs:restriction base="xs:string"> <xs:maxLength value="32"/> <xs:minLength value="1"/> <xs:pattern value="([^\t\n\r])*"/> </xs:restriction> </xs:simpleType> </pre> | | | | | | | | | | | | |

simpleType TETreatmentType

| namespace | urn:bridgeall-com:cmaservice:data:v3 | | | | | | | | | | | | |
|--------------------------------------|-----------------------------------------------------------------------------------------------------------------------------------------------------------------------------------------------------------------------------------------------------------------------------------------------------------------------------------------------------------------------------------------------------------------|--------------------------------------|-------|------------|-------------|-----------|--|-------------|---------|---|-------------|-------------|--|
| type | restriction of xs:string | | | | | | | | | | | | |
| properties | base xs:string | | | | | | | | | | | | |
| used by | element D6011 TETreatment | | | | | | | | | | | | |
| facets | <table border="1"> <thead> <tr> <th>Kind</th> <th>Value</th> <th>annotation</th> </tr> </thead> <tbody> <tr> <td>enumeration</td> <td>Secondary</td> <td></td> </tr> <tr> <td>enumeration</td> <td>Primary</td> <td></td> </tr> <tr> <td>enumeration</td> <td>Sub-Primary</td> <td></td> </tr> </tbody> </table> | Kind | Value | annotation | enumeration | Secondary | | enumeration | Primary | | enumeration | Sub-Primary | |
| Kind | Value | annotation | | | | | | | | | | | |
| enumeration | Secondary | | | | | | | | | | | | |
| enumeration | Primary | | | | | | | | | | | | |
| enumeration | Sub-Primary | | | | | | | | | | | | |
| annotation | <p>documentation</p> <table border="1"> <tbody> <tr> <td colspan="3">Enumeration of TETreatment indicator</td> </tr> <tr> <td>Secondary</td> <td>0</td> <td></td> </tr> <tr> <td>Primary</td> <td></td> <td>1</td> </tr> <tr> <td>Sub-Primary</td> <td>2</td> <td></td> </tr> </tbody> </table> | Enumeration of TETreatment indicator | | | Secondary | 0 | | Primary | | 1 | Sub-Primary | 2 | |
| Enumeration of TETreatment indicator | | | | | | | | | | | | | |
| Secondary | 0 | | | | | | | | | | | | |
| Primary | | 1 | | | | | | | | | | | |
| Sub-Primary | 2 | | | | | | | | | | | | |
| source | <pre> <xs:simpleType name="TETreatmentType"> <xs:annotation> <xs:documentation> Enumeration of TETreatment indicator Secondary 0 Primary 1 Sub-Primary 2 </xs:documentation> </xs:annotation> <xs:restriction base="xs:string"> <xs:enumeration value="Secondary"/> </xs:restriction> </xs:simpleType> </pre> | | | | | | | | | | | | |

| | |
|--|-------------------------------------------------------------------------------------------------------------------------------------------------|
| | <pre> <xs:enumeration value="Primary"/> <xs:enumeration value="Sub-Primary"/> </xs:restriction> </xs:simpleType> </pre> |
|--|-------------------------------------------------------------------------------------------------------------------------------------------------|

simpleType **UARNAbsenceCodeType**

| namespace | urn:bridgeall-com:cmaservice:data:v3 | | | | | | | | | | | | | | | | | | | | | | | | | | | | | | | | | | | | | | | |
|----------------------|----------------------------------------------------------------------------------------------------------------------------------------------------------------------------------------------------------------------------------------------------------------------------------------------------------------------------------------------------------------------------------------------------------------------------------------------------------------------------------------------------------------------------------------------------------------------------------------------------------------------------------------------------------------------------------------------------------------------------------------------------------------------------------------------------------------------------------------------------------------------------------------------------------------------------------------------|------------------------------------------|--------------|------------|-------------|----|----------------------------|-------------|----|------------------------------------------|-------------|----|------------------------------------------|-------------|----|--------------------------------------|-------------|----|---------------------------|-------------|----|---------------------|-------------|----|------------------------|-------------|----|----------------|-------------|----|-------|-------------|----|------------------------|-------------|----|----------|-------------|----|----------------|
| type | restriction of xs:string | | | | | | | | | | | | | | | | | | | | | | | | | | | | | | | | | | | | | | | |
| properties | base xs:string | | | | | | | | | | | | | | | | | | | | | | | | | | | | | | | | | | | | | | | |
| used by | element UARNTyp/D2038 SAAResponseNumberAbsenceCode | | | | | | | | | | | | | | | | | | | | | | | | | | | | | | | | | | | | | | | |
| facets | <table border="1"> <thead> <tr> <th>Kind</th> <th>Value</th> <th>annotation</th> </tr> </thead> <tbody> <tr><td>enumeration</td><td>ME</td><td></td></tr> <tr><td>enumeration</td><td>AG</td><td></td></tr> <tr><td>enumeration</td><td>SR</td><td></td></tr> <tr><td>enumeration</td><td>RC</td><td></td></tr> <tr><td>enumeration</td><td>MT</td><td></td></tr> <tr><td>enumeration</td><td>CU</td><td></td></tr> <tr><td>enumeration</td><td>IP</td><td></td></tr> <tr><td>enumeration</td><td>BW</td><td></td></tr> <tr><td>enumeration</td><td>OT</td><td></td></tr> <tr><td>enumeration</td><td>NR</td><td></td></tr> <tr><td>enumeration</td><td>CP</td><td></td></tr> <tr><td>enumeration</td><td>TS</td><td></td></tr> </tbody> </table> | Kind | Value | annotation | enumeration | ME | | enumeration | AG | | enumeration | SR | | enumeration | RC | | enumeration | MT | | enumeration | CU | | enumeration | IP | | enumeration | BW | | enumeration | OT | | enumeration | NR | | enumeration | CP | | enumeration | TS | |
| Kind | Value | annotation | | | | | | | | | | | | | | | | | | | | | | | | | | | | | | | | | | | | | | |
| enumeration | ME | | | | | | | | | | | | | | | | | | | | | | | | | | | | | | | | | | | | | | | |
| enumeration | AG | | | | | | | | | | | | | | | | | | | | | | | | | | | | | | | | | | | | | | | |
| enumeration | SR | | | | | | | | | | | | | | | | | | | | | | | | | | | | | | | | | | | | | | | |
| enumeration | RC | | | | | | | | | | | | | | | | | | | | | | | | | | | | | | | | | | | | | | | |
| enumeration | MT | | | | | | | | | | | | | | | | | | | | | | | | | | | | | | | | | | | | | | | |
| enumeration | CU | | | | | | | | | | | | | | | | | | | | | | | | | | | | | | | | | | | | | | | |
| enumeration | IP | | | | | | | | | | | | | | | | | | | | | | | | | | | | | | | | | | | | | | | |
| enumeration | BW | | | | | | | | | | | | | | | | | | | | | | | | | | | | | | | | | | | | | | | |
| enumeration | OT | | | | | | | | | | | | | | | | | | | | | | | | | | | | | | | | | | | | | | | |
| enumeration | NR | | | | | | | | | | | | | | | | | | | | | | | | | | | | | | | | | | | | | | | |
| enumeration | CP | | | | | | | | | | | | | | | | | | | | | | | | | | | | | | | | | | | | | | | |
| enumeration | TS | | | | | | | | | | | | | | | | | | | | | | | | | | | | | | | | | | | | | | | |
| annotation | <p>documentation</p> <table border="1"> <thead> <tr> <th>SAA Reference Number</th> <th>Absence Code</th> <th></th> </tr> </thead> <tbody> <tr><td>ME</td><td>0</td><td>Missing Entry from the SAA</td></tr> <tr><td>AG</td><td>1</td><td>Agricultural land, buildings and troughs</td></tr> <tr><td>SR</td><td>2</td><td>Fish farms, fishing, and sporting rights</td></tr> <tr><td>RC</td><td>3</td><td>Parks, Allotments and Sports Grounds</td></tr> <tr><td>MT</td><td>4</td><td>Property is multi-tenancy</td></tr> <tr><td>CU</td><td>5</td><td>Cumulo Supply Point</td></tr> <tr><td>IP</td><td>6</td><td>Infrastructure Project</td></tr> <tr><td>BW</td><td>7</td><td>Building Water</td></tr> <tr><td>OT</td><td>8</td><td>Other</td></tr> <tr><td>NR</td><td>9</td><td>Property not yet rated</td></tr> <tr><td>CP</td><td>10</td><td>Car Park</td></tr> <tr><td>TS</td><td>11</td><td>To Be Supplied</td></tr> </tbody> </table> | SAA Reference Number | Absence Code | | ME | 0 | Missing Entry from the SAA | AG | 1 | Agricultural land, buildings and troughs | SR | 2 | Fish farms, fishing, and sporting rights | RC | 3 | Parks, Allotments and Sports Grounds | MT | 4 | Property is multi-tenancy | CU | 5 | Cumulo Supply Point | IP | 6 | Infrastructure Project | BW | 7 | Building Water | OT | 8 | Other | NR | 9 | Property not yet rated | CP | 10 | Car Park | TS | 11 | To Be Supplied |
| SAA Reference Number | Absence Code | | | | | | | | | | | | | | | | | | | | | | | | | | | | | | | | | | | | | | | |
| ME | 0 | Missing Entry from the SAA | | | | | | | | | | | | | | | | | | | | | | | | | | | | | | | | | | | | | | |
| AG | 1 | Agricultural land, buildings and troughs | | | | | | | | | | | | | | | | | | | | | | | | | | | | | | | | | | | | | | |
| SR | 2 | Fish farms, fishing, and sporting rights | | | | | | | | | | | | | | | | | | | | | | | | | | | | | | | | | | | | | | |
| RC | 3 | Parks, Allotments and Sports Grounds | | | | | | | | | | | | | | | | | | | | | | | | | | | | | | | | | | | | | | |
| MT | 4 | Property is multi-tenancy | | | | | | | | | | | | | | | | | | | | | | | | | | | | | | | | | | | | | | |
| CU | 5 | Cumulo Supply Point | | | | | | | | | | | | | | | | | | | | | | | | | | | | | | | | | | | | | | |
| IP | 6 | Infrastructure Project | | | | | | | | | | | | | | | | | | | | | | | | | | | | | | | | | | | | | | |
| BW | 7 | Building Water | | | | | | | | | | | | | | | | | | | | | | | | | | | | | | | | | | | | | | |
| OT | 8 | Other | | | | | | | | | | | | | | | | | | | | | | | | | | | | | | | | | | | | | | |
| NR | 9 | Property not yet rated | | | | | | | | | | | | | | | | | | | | | | | | | | | | | | | | | | | | | | |
| CP | 10 | Car Park | | | | | | | | | | | | | | | | | | | | | | | | | | | | | | | | | | | | | | |
| TS | 11 | To Be Supplied | | | | | | | | | | | | | | | | | | | | | | | | | | | | | | | | | | | | | | |
| source | <pre> <xs:simpleType name="UARNAbsenceCodeType"> <xs:annotation> <xs:documentation> SAA Reference Number Absence Code ME 0 Missing Entry from the SAA AG 1 Agricultural land, buildings and troughs SR 2 Fish farms, fishing, and sporting rights RC 3 Parks, Allotments and Sports Grounds MT 4 Property is multi-tenancy CU 5 Cumulo Supply Point IP 6 Infrastructure Project BW 7 Building Water OT 8 Other NR 9 Property not yet rated CP 10 Car Park TS11 To Be Supplied </xs:documentation> </xs:annotation> </xs:simpleType> </pre> | | | | | | | | | | | | | | | | | | | | | | | | | | | | | | | | | | | | | | | |

```

</xs:annotation>
<xs:restriction base="xs:string">
  <xs:enumeration value="ME"/>
  <xs:enumeration value="AG"/>
  <xs:enumeration value="SR"/>
  <xs:enumeration value="RC"/>
  <xs:enumeration value="MT"/>
  <xs:enumeration value="CU"/>
  <xs:enumeration value="IP"/>
  <xs:enumeration value="BW"/>
  <xs:enumeration value="OT"/>
  <xs:enumeration value="NR"/>
  <xs:enumeration value="CP"/>
  <xs:enumeration value="TS"/>
</xs:restriction>
</xs:simpleType>

```

simpleType UPRNAbsenceCodeType

| namespace | urn:bridgeall-com:cmaservice:data:v3 | | | | | | | | | | | | | | | | | | | | | | | | | | | | | | | | | | | | |
|-------------|-------------------------------------------------------------------------------------------------------------------------------------------------------------------------------------------------------------------------------------------------------------------------------------------------------------------------------------------------------------------------------------------------------------------------------------------------------------------------------------------------------------------------------------------------------------------------------------------------------------------------------------------------------------------------------------------------|------------|-------|------------|-------------|----|--|-------------|----|--|-------------|----|--|-------------|----|--|-------------|----|--|-------------|----|--|-------------|----|--|-------------|----|--|-------------|----|--|-------------|----|--|-------------|----|--|
| type | restriction of xs:string | | | | | | | | | | | | | | | | | | | | | | | | | | | | | | | | | | | | |
| properties | base xs:string | | | | | | | | | | | | | | | | | | | | | | | | | | | | | | | | | | | | |
| used by | element UPRNTYPE/D2040 UPRNAbsenceCode | | | | | | | | | | | | | | | | | | | | | | | | | | | | | | | | | | | | |
| facets | <table border="1"> <thead> <tr> <th>Kind</th> <th>Value</th> <th>annotation</th> </tr> </thead> <tbody> <tr><td>enumeration</td><td>ME</td><td></td></tr> <tr><td>enumeration</td><td>AG</td><td></td></tr> <tr><td>enumeration</td><td>SR</td><td></td></tr> <tr><td>enumeration</td><td>RC</td><td></td></tr> <tr><td>enumeration</td><td>MT</td><td></td></tr> <tr><td>enumeration</td><td>CU</td><td></td></tr> <tr><td>enumeration</td><td>IP</td><td></td></tr> <tr><td>enumeration</td><td>BW</td><td></td></tr> <tr><td>enumeration</td><td>OT</td><td></td></tr> <tr><td>enumeration</td><td>PL</td><td></td></tr> <tr><td>enumeration</td><td>TS</td><td></td></tr> </tbody> </table> | Kind | Value | annotation | enumeration | ME | | enumeration | AG | | enumeration | SR | | enumeration | RC | | enumeration | MT | | enumeration | CU | | enumeration | IP | | enumeration | BW | | enumeration | OT | | enumeration | PL | | enumeration | TS | |
| Kind | Value | annotation | | | | | | | | | | | | | | | | | | | | | | | | | | | | | | | | | | | |
| enumeration | ME | | | | | | | | | | | | | | | | | | | | | | | | | | | | | | | | | | | | |
| enumeration | AG | | | | | | | | | | | | | | | | | | | | | | | | | | | | | | | | | | | | |
| enumeration | SR | | | | | | | | | | | | | | | | | | | | | | | | | | | | | | | | | | | | |
| enumeration | RC | | | | | | | | | | | | | | | | | | | | | | | | | | | | | | | | | | | | |
| enumeration | MT | | | | | | | | | | | | | | | | | | | | | | | | | | | | | | | | | | | | |
| enumeration | CU | | | | | | | | | | | | | | | | | | | | | | | | | | | | | | | | | | | | |
| enumeration | IP | | | | | | | | | | | | | | | | | | | | | | | | | | | | | | | | | | | | |
| enumeration | BW | | | | | | | | | | | | | | | | | | | | | | | | | | | | | | | | | | | | |
| enumeration | OT | | | | | | | | | | | | | | | | | | | | | | | | | | | | | | | | | | | | |
| enumeration | PL | | | | | | | | | | | | | | | | | | | | | | | | | | | | | | | | | | | | |
| enumeration | TS | | | | | | | | | | | | | | | | | | | | | | | | | | | | | | | | | | | | |
| annotation | documentation UPRN Absence Code ME 0 Missing Entry from the OSG AG 1 Agricultural including troughs SR 2 Fish farms, fishing, and sporting rights RC 3 Parks, Allotments and Sports Grounds MT 4 Property is multi-tenancy CU 5 Cumulo Supply Point IP 6 Infrastructure Project BW 7 Building Water OT 8 Other PL 9 Not yet issued by planning TS 10 To Be Supplied | | | | | | | | | | | | | | | | | | | | | | | | | | | | | | | | | | | | |
| source | <xs:simpleType name="UPRNAbsenceCodeType"> <xs:annotation> <xs:documentation> UPRN Absence Code ME 0 Missing Entry from the OSG AG 1 Agricultural including troughs SR 2 Fish farms, fishing, and sporting rights | | | | | | | | | | | | | | | | | | | | | | | | | | | | | | | | | | | | |

| | | | |
|--|-----------------------------------|----|--------------------------------------|
| | RC | 3 | Parks, Allotments and Sports Grounds |
| | MT | 4 | Property is multi-tenancy |
| | CU | 5 | Cumulo Supply Point |
| | IP | 6 | Infrastructure Project |
| | BW | 7 | Building Water |
| | OT | 8 | Other |
| | PL | 9 | Not yet issued by planning |
| | TS | 10 | To Be Supplied |
| | </xs:documentation> | | |
| | </xs:annotation> | | |
| | <xs:restriction base="xs:string"> | | |
| | <xs:enumeration value="ME"/> | | |
| | <xs:enumeration value="AG"/> | | |
| | <xs:enumeration value="SR"/> | | |
| | <xs:enumeration value="RC"/> | | |
| | <xs:enumeration value="MT"/> | | |
| | <xs:enumeration value="CU"/> | | |
| | <xs:enumeration value="IP"/> | | |
| | <xs:enumeration value="BW"/> | | |
| | <xs:enumeration value="OT"/> | | |
| | <xs:enumeration value="PL"/> | | |
| | <xs:enumeration value="TS"/> | | |
| | </xs:restriction> | | |
| | </xs:simpleType> | | |