

Market Code Schedule 9

Code Subsidiary Document No. 0101

Registration: New Connections & New
Supply Points

Version: 18

Date: 2022-03-24

Document Ref: CSD0101

Change History

Version Number	Date of Issue	Reason For Change	Change Control Reference	Sections Affected
1.0	11/05/2007			
1.0 Revision- marked	10/08/2007	Reissue for errata and clarifications		
1.1	31/08/2007	Updated version including new transactions		
1.2	01/06/2008	Commission originated change to process Ref 3.4 where Scottish Water become aware of a Gap Site		
		Four errata corrections	MCCP013	
1.3	27/07/2009	Re-assessed Charges Correction to flow in Diagram on Page 22	MCCP035-CC	Sections 1; 3.1 and 3.1.1
1.4	28/06/10	Customer Names on Database X, Y Co-ordinates	MCCP041-CC MCCP048-CC	Sections 2.1.1, 2.2, 2.3, 3.1.1, 3.2, 3.3, 3.4.1, 3.5, 3.6, 3.4.1, 3.5, 3.6 and Appendix 1
1.5	27/09/2010	T016 Unmeasureable Status Fix	MCCP055	Sections 2.1, 3.1, 3.4.1
		Removal of T031 Transaction Updating effective / connection dates	MCCP057 MCCP063, MCCP064	Section 2.1, 3.1.1 Section 2.1, and 3.4, Appendix 1
1.6	25/03/2011	Data loggers	MCCP070	Sections 2.1.1, 3.1.1, 3.4.1
		GIS Coordinates Flow T016 Effective Date and Sewerage Services Supply Point update Partial Escalation Process	MCCP071 MCCP072, MCCP075 MCCP074	Sections 2.1.1, 3.1.1, 3.4.1 Sections 3.1.1 and 3.1.4 Sections 2.1.1
1.7	11/11/2011	Addition of Metered Building Water Flag (T033.0, T033.1)	MCCP081-CC	Sections 2.1, 2.2, 2.3, 3.1, 3.2, 3.3, 3.4, 3.5 and 3.6
		September Release CSD Marking	MCCP088	Sections 2.1.1, 3.1.1, 3.4.1, Appendix 1
1.8	30/03/2012	Introduction of SPID Deregistration	MCCP052-079	Sections 2.1.1
2.0	21/06/2012	Changes to the connection process so that the SPID connection message no longer needs to be the final message to make a SPID Tradeable	MCCP093 / MCCP102	Sections 2, 3 & 4.

Version Number	Date of Issue	Reason For Change	Change Control Reference	Sections Affected
3.0	12/04/13	Identifies private meters and accredited entities.	MCCP095, MCCP111, MCCP113	Section 4.
4.0	27/09/13	Changes to X, Y Data, addition of the Meter Location Code and correction to T006.2/3 processing	MCCP104, MCCP112	Section 4.1
5.0	2014-03-21	New Meter Treatments	MCCP129	Section 4.1
6.0	2015-03-31	SAA Refs/UPRNs Notifications to SW Late Partial Registration Report	MCCP127 MCCP131 MCCP153	Section 2, 4
7.0	2015-09-24	Gap Site Process	MCCP183-CC	Sections 3.2 and 4.3
8.0	2016-02-17	Gap Site Process Amendment	MCCP193	Section 3
9.0	2016-09-30	LP Connection Reference	MCCP197	Section 2.1.1
10.0	2017-03-16	Live RVs	MCCP201	Section 4.1
11.0	2018-02-01	Live Rateable Value in Settlement New SPID Processing Timescales Criteria for Live RV Updates	MCCP214-CC MCCP220 MCCP222-CC	Sections 3 and 4 Section 2 Section 3
12.0	2019-03-28	Default and Nominal Live RV as defined terms.	MCCP236	Section 4
13.0	2019-10-24	Transaction Name changes	MCCP242	Various Sections
14.0	2020-03-26	SS SPID Connection Ownership change WSoC Changes Timings of meter reads	MCCP239 MCCP247-CC MCCP111	Various Sections Section 4 Section 4
15.0	2020-12-02	TTRAN SPIDs T004.0 Validation	MCCP256 MCCP258	Appendix 1 Section 4
16.0	2021-04-16	Notification of a T006.8 described.	MCCP250	Section 4
17.0	2021-09-23	Transaction Name changes Change of use	MCCP262	Various Sections Section 3.3
18.0	2022-03-24	Multiple UPRNs	MCCP269	Section 2.1.1

Table of Contents

1.	Purpose and scope	5
2.	New Connections	6
2.1	Process Description	6
3.	New Supply Points - Entry Change of Use or Gap Site	11
3.1	Licensed Provider Initiated	11
3.2	Where Scottish Water becomes aware of a Gap Site	13
3.3	Where Scottish Water becomes aware of an Entry Change of Use	14
4.	Common Phases of the Connection Process	15
4.1	Description of Process Steps	15
4.2	Process Diagrams	25
4.3	Interface and Timetable Requirements	30
	Appendix 1: Registration Data Checks at a New Connection/New Supply Point	34
	Appendix 2 : Process Flowchart Symbols	38

1. Purpose and scope

This document outlines the process followed in order to create and Register New Connections and New Supply Points.

It is essential to manage the timely notification of New Connections and New Supply Points in advance to the CMA. The relevant information must reach the CMA in good time to ensure that:

- The CMA can create a SPID;
- The Partial Registration Application can be submitted by the Licensed Provider(s);
- Meter(s) information and the Initial Read(s) can be notified; and
- Service Elements can be notified so that Wholesale Charges can commence from the Connection Date.

The CMA will create the new SPID(s) and the Licensed Provider(s) will undertake a Partial Registration before all of the SPID Data is complete. This CSD sets out the process for the Partial Registration Application and the notification of SPID Data so that the Registration can be completed.

Sections 2 and 3 describe the initial phases of the connections processes for the Registration of; New Connections and New Supply Points (i.e. Entry Change of Use or Gap Sites respectively), while Section 4 describes the later common phases of the connections processes. For the avoidance of doubt, a Licensed Provider wishing to Register a Supply Point pursuant to an Entry Change of Use or in relation to a Gap Site should follow the process in Section 3. For ease of reference, the treatment of an Exit Change of Use is set out in CSD0104 (Maintain SPID Data).

Out of Scope

Whilst the processes for creating and Registering Pseudo Water Services Supply Points are comparable to those set out in this CSD0101, a new Pseudo Water Services Supply Points must be managed in accordance with CSD0104 'Maintain SPID Data' Section 7 as they are exclusive to Supply Points with Pseudo Meters for the purpose of Re-Assessed Charges.

2. New Connections

2.1 Process Description

Processes 1-4 of the Operational Code cover the procedures between Scottish Water and the Licensed Providers for New Connections. This Section sets out the initial steps that Scottish Water, Licensed Providers and the CMA will follow in respect of the Registration of a New Connection and its progression into the Settlement Process. The completion of the process is set out in Section 4, which is common to both New Connections and New Supply Points.

2.1.1 Description of the Process Diagram Steps

This description should be read in conjunction with the Process Diagram in Section 4.2 and the Interface and Timetable Requirements in Section 4.3. The 'step' and 'decision' references appear to the bottom left of each step or decision symbol in the Process Diagram. References shown thus [T001] relate to the associated Data Transaction, as set out in the Data Transaction Catalogue.

Steps a and b: Request new SPID [T001.0]

Scottish Water shall issue a request for new Supply Point(s) for the New Connection(s), using Data Transaction T001.0 (Request New SPID). The T001 request will include the following information:

- 1) Confirmation of whether the New Connection(s) relates to Water Services or Sewerage Services or both and the Licensed Provider(s) involved in the connection offer(s) under the Operational Code. The rules for this confirmation are set out below;

Where the New Connection relates to:

- (i) Both new Water and new Sewerage Services, then Scottish Water will include both of those Services Categories and the Licensed Provider for each Service Category in the T001.0 (Request New SPID). In the event that the same Licensed Provider is involved in the connection offer under the Operational Code for both the Water Services and Sewerage Services, Scottish Water will notify the identity of the Licensed Provider at each of the Water Services Supply Point and/or Sewerage Services Supply Point by following the rules in CSD0301 (Data Transaction Catalogue).

OR

- (ii) Sewerage Services without Water Services or Water Services without Sewerage Services, the T001.0 will include only the relevant category of Service as well as the Licensed Provider they are dealing with under the relevant Operational Code process.

OR

- (iii) Water Services at a Supply Point that has not previously received Water Services but has received Sewerage Services only, the T001.0 will include the Additional Service Category. Scottish Water shall also notify the CMA of the Licensed Provider they are dealing with under the relevant Operational Code process. In addition, the Supply Point for the existing Sewerage Services shall be included in the T001.0 to ensure that the Additional Services are associated. Licensed Providers shall ensure that they have referenced the existing Sewerage Services Supply Point in the relevant application under the Operational Code. In the event that any Water Services previously received at the Supply Point were subject to a Permanent Disconnection or Deregistration (see CSD0104 (Maintain SPID Data)) then the New Connection shall be in respect of both Water and Sewerage Services as set out in (v) below.

OR

- (iv) Sewerage Services at a Supply Point that has not previously received Sewerage Services but has received Water Services only, the T001.0 will include the Additional Service Category and the Supply Point for the existing Water Services to ensure that the Additional Services are associated with that Supply Point. Licensed Providers shall ensure that they have referenced the existing Water Services Supply Point in the relevant application under the Operational Code. Scottish Water shall also notify the CMA of the Licensed Provider they are dealing with under the relevant Operational Code process. In the event that the Sewerage Services previously received at the Supply Point were subject to a Permanent Disconnection or Deregistration (see CSD0104 (Maintain SPID Data)) then the New Connection shall be in respect of both Water and Sewerage Services, as set out in (v) below

OR

- (v) Both Water and Sewerage Services where either or both of those Services have previously been subject to a Permanent Disconnection or Deregistration, then the T001.0 will include both of those Services Categories and the Licensed Provider for each Service in the T001.0 (Request New SPID). Furthermore, where that existing Supply Point in respect of Water Services or Sewerage Services is registered, this will be superseded by the New Connection in respect of the Water or Sewerage Services (as applicable). In this circumstance, Licensed Providers shall ensure that they have referenced the existing Water Services or Sewerage Services (as applicable) in the relevant application under the Operational Code and Scottish Water shall ensure that the CMA is duly notified of the Permanent Disconnection or Deregistration of the existing Water Services or Sewerage Services (as applicable) in accordance with CSD0104 (Maintain SPID Data).

AND

- 2) The Supply Point address (as known to Scottish Water at the time of submitting the T001.0;

AND

- 3) Confirmation of the Supply Point reference in the connection offer under the Operational Code in order that the association between that reference and the newly created SPID(s) can be communicated to the Licensed Provider(s). For the avoidance of doubt, the CMA will not maintain this association, nor will it be continued in the Central Systems once the Partial Registration(s) is in place.

AND

- 4) The unique SAA Reference Number, which must be unique to a single Supply Point or Supply Point core

Or

The reason for not providing the SAA Reference Number

AND

- 5) The UPRN (Unique Property Reference Number), which may apply to one or more Supply Points or Supply Point cores, as published in the One Scotland Gazetteer

Or

The reason for not providing the UPRN;

AND

- 6) The LP Connection Reference, if this has been provided by the Licensed Provider.

Step c: Notify new SPID [T002.0 and T002.1]

Within 1 Business Day of receipt of the information at step b above, the CMA will create the new Supply Point(s). The CMA will then send notification of the Supply Points to Scottish Water, using Data Transaction T002.1 (Notify New SPID (SW)), and the relevant Licensed Provider(s), using Data Transaction T002.0 (Notify New SPID (LP)).

- i. In the case of a Licensed Provider, this notification will constitute a request to submit a T003.0 (Partial Registration Application) or a T009.2 (Reject New SPID) (see Step d below).
- ii. In the case of Scottish Water, this notification will constitute a request to submit the supporting information for the Supply Point for which they are the Data Owner.

For the avoidance of doubt, the CMA will monitor newly created Supply Points in accordance with CSD0002 (Performance Standards) in order to ensure that Partial Registration Applications are received in a timely manner, and that such Registrations proceed to completion.

Step d: Submit Partial Registration Application [T003.0] or Error Notification [T009.2] Submit Partial Registration Application [T003.0]

Where the Licensed Provider is involved in the New Connection, it will submit a Partial Registration Application using Data Transaction T003.0 (Partial Registration Application) within 5 Business Days of the issue of the T002.0 by the CMA.

Where the New Connection relates to Water Services and Sewerage Services, a Partial Registration Application must be submitted in relation to each Supply Point, regardless of whether one Licensed Provider who is the holder of both Licence types provides each of the Services Category at the SPIDs.

Submit Error Notification [T009.2]

Where a Licensed Provider considers they are not the Licensed Provider involved in the New Connection, that Licensed Provider shall submit notification of such to the CMA within 5 Business Days of the CMA issuing the [Data Transaction] T002.0 (Notify New SPID (LP)), The Licensed Provider will submit Data Transaction T009.2 (Reject New SPID). The CMA will then seek clarification from Scottish Water using Data Transaction T009.1 (Notify Error/Acceptance (SW)), who shall correct the notification of the Licensed Provider for that Supply Point within 1 Business Day by issuing another T001.0 which shall include the Supply Point and the appropriate Licensed Provider. In the event that Scottish Water has no other information than that already notified to the CMA, they shall advise the CMA of this and the CMA shall escalate the matter to the Licensed Provider's Contract Manager.

Step e: Process Partial Registration Application

Upon receipt of the Partial Registration Application(s), the Licensed Provider so registered will become the Data Owner for the relevant SPID Data and will be responsible for providing the outstanding SPID Data to the CMA in order to complete the Registration. *Note:* While for almost all SPIDs there will be a requirement for the Licensed Provider to submit further SPID Data, in rare circumstances involving the addition of a Supply Point to an existing associated Supply Point it is possible that, at this stage in the process, enough data has already been submitted to complete the Registration. Accordingly, the check described in Decision m (in Section 4) is carried out at this point in the process.

Late Partial Registration Application

In the event that a Partial Registration Application(s) has not been received within 5 Business Days, of the CMA issuing the T002.0 (Notify New SPID (LP)) to the Licensed Provider(s), or the Licensed Provider(s) has not submitted a T009.2 (Reject New SPID) at step d above, the CMA will escalate the matter on a monthly basis by provision of a report to that Licensed Provider's Contract Manager or other person as nominated by the Contract Manager. The report will include; the Supply Point, the New Connection Type, the date and time of the

associated T002.0 transaction and the message ID for that T002.0 transaction. Supply Points which have been deregistered will not however be included in the report.

Steps f-p: Provide Data and Make SPID Tradeable

These processes are common to both New Connections and New Supply Points and are described in Section 4.

3. New Supply Points - Entry Change of Use or Gap Site

This Section sets out the initial process to be followed in respect of the Registration of New Supply Points. This section reflects the fact that there will be no physical connection work required in respect of New Supply Points. The final phases of the process, which are common to both New Connections and New Supply Points, are set out in Section 4.

Creation of Pseudo Water Services Supply Points are not within the scope of this CSD, and such Supply Points are managed solely under Section 7 of CSD0104 (Maintain SPID Data).

The logical processing will follow the order set out below.

3.1 *Licensed Provider Initiated*

Where a Licensed Provider becomes aware of an Entry Change of Use¹ or a Gap Site

3.1.1 Description of the Process Diagram Steps

This description should be read in conjunction with the Process Diagram in Section 4.2 and the Interface and Timetable Requirements in Section 4.3. The 'step' and 'decision' references appear to the bottom left of each step or decision symbol in the Process Diagram. References shown thus [T001.0] relate to the associated Data Transaction in the Data Transaction Catalogue.

Step a: Identify Entry Change of Use or Gap Site

Within 10 Business Days of becoming aware of a Gap Site or an Entry Change of Use (other than at a Sewerage Services Only Supply Point which is to be subject to Re-assessed Charges, which is covered in CSD0104 Section 7), the Licensed Provider will notify Scottish Water of the New Supply Point(s) and the reason for the requirement (i.e. Entry Change of Use or Gap Site).

Step b: Request Supply Point(s) [T001.0]

Scottish Water shall endeavour to identify any information regarding the premises from its records, including assessing whether a site visit will be required to verify the Services at the Supply Point(s), in which case they should liaise with the Licensed Provider(s) in accordance with the Operational Code.

Scottish Water will submit the T001.0 (Request New SPID) to the CMA no later than 5 Business Days after receiving notification from the Licensed Provider(s) at Step a above. The submission will reflect that the New Supply Point(s) arises from an Entry Change of Use or Gap Site and whether the Supply Point(s) relates to both Water and Sewerage Services, or only one of those

¹ For the avoidance of doubt, this does not include a new Pseudo Water Services Supply Point in respect of Re-assessed charges, which is set out in CSD0104 Section 7.

Services. The Licensed Provider who notified Scottish Water of the New Supply Point shall be identified in the T001.0 request.

Step c: Create Supply Points and issue SPIDs [T002.0, T002.1]

The CMA will issue the SPIDs within 1 Business Day of receipt of the T001.0, using, Data Transaction T002.1 (Notify New SPID (SW)) to Scottish Water and Data Transaction T002.0 (Notify New SPID (LP)) to the relevant Licensed Provider(s).

- iii. In the case of a Licensed Provider, this notification will constitute a request to submit a T003.0 (Partial Registration Application) or a T009.2 (Reject New SPID) (see Step d below).
- iv. In the case of Scottish Water, this notification will constitute a request to submit the supporting information for the Supply Point for which they are the Data Owner.

Steps d and e: Process Partial Registrations [T003.0, T009.2]

Where a Licensed Provider(s) considers that they are involved in the New Supply Point, they shall submit a Partial Registration Application using Data Transaction T003.0 within 5 Business Days of receiving the T002.0 (Notify New SPID (LP)).

Where a Licensed Provider considers they are not involved, that Licensed Provider shall submit notification of such to the CMA within 5 Business Days of the CMA issuing the T002.0 (Notify New SPID (LP)) using the Data Transaction T009.2 (Reject New SPID). The CMA will then seek clarification from Scottish Water using Data Transaction T009.1 (Notify Error/Acceptance (SW)), who shall correct the notification of the Licensed Provider for that Supply Point(s) within 1 Business Day by issuing another T001.0 which shall include the Supply Point(s) and the appropriate Licensed Provider. In the event that Scottish Water has no other information than that already notified to the CMA, they shall advise the CMA of this and the CMA shall escalate the matter to the Licensed Provider's Contract Manager.

Steps f-p: Provide Data and Make SPID Tradeable

These processes are common to both New Connections and New Supply Points and are described in Section 4.

3.2 Where Scottish Water becomes aware of a Gap Site

3.2.1 Description of the Process Diagram Steps

Step a: Identify Gap Site

On identifying a Gap Site, Scottish Water shall endeavour to identify any information regarding the premises from its records, including assessing whether a site visit will be required to verify the Services at the Supply Point(s).

Step b: Request Supply Point(s) [T001.0]

Once Scottish Water has written to the non-household Customer in accordance with the Gap Site Allocation Process and no Licensed Provider(s) has been chosen by the Customer, Scottish Water will, within 17 Business Days of the date of its letter to the non-household Customer, submit the T001.0 (Request New SPID) to the CMA. The submission will reflect that the New Supply Point(s) arises from a Gap Site, whether the Supply Point(s) relates to both Water and Sewerage Services, or only one of those Services and, since no Licensed Provider has been involved, will not include any information regarding the identity of a Licensed Provider.

Step c: Create Supply Point(s) and issue SPID(s) to Scottish Water [T002.1]

The CMA will create the Supply Point(s) and notify Scottish Water within 1 Business Day of allocating the Supply Point(s) to a Licensed Provider(s) (see step c, using Data Transaction T002.1 (Notify New SPID (SW))). This notification will constitute a request to submit the supporting information for the Supply Point(s) for which they are the Data Owner.

Step c: Allocate Supply Point(s) to Licensed Provider and notify SPIDs [T002.0]

The CMA will allocate the Supply Point(s) to a Licensed Provider(s) in accordance with the Gap Site Allocation Process.

The CMA will notify the Licensed Provider(s) of the Supply Point(s) so allocated within 1 Business Day of receipt of the T001.0 in respect of that Supply Point(s), using Data Transaction T002.0 (Notify New SPID (LP)). This notification will constitute a request for that Licensed Provider(s) to submit a T003.0 (Partial Registration Application).

Step c1: Send Copy of Gap Site letter to Licensed Provider

Scottish Water shall send to the allocated Licenced Provider upon request a copy of the letter sent to the non-household Customer.

Step d: Submit Partial Registrations [T003.0]

The Licensed Provider(s) shall submit a Partial Registration Application using Data Transaction T003.0 (Partial Registration Application) within 5 Business Days of receiving the T002.0 (Notify New SPID (LP)).

Step e: Process Partial Registrations

The CMA will load the data to the Central Systems.

Steps f-p: Provide Data and Make SPID Tradeable

These processes are common to both New Connections and New Supply Points and are described in Section 4.

3.3 Where Scottish Water becomes aware of an Entry Change of Use

Entry Change of Use may relate to SPID creation as a result of configuration changes or a change of use of existing SPIDs.

Where such a change of use requires the alignment of Live Rateable Value across existing SPIDs and resulting new SPIDs (for example splits/merges), there may be a requirement to backdate the new SPID Connection Date to the appropriate Live Rateable Value date to ensure continuity of charging..

3.3.1 Description of the Process Diagram Steps

Step a: Identify site subject to configurations change / Entry Change of Use

On identifying a site subject to Entry Change of Use, Scottish Water shall endeavour to identify any information regarding the premises from its records, including assessing whether a site visit will be required to verify the Services at the Supply Point(s).

Step b: Request Supply Point(s) [T001.0]

Scottish Water will submit the T001.0 (Request New SPID) to the CMA, the submission will reflect that the New Supply Point(s) arises from an Entry Change of Use, whether the Supply Point(s) relates to both Water and Sewerage Services, or only one of those Services. New SPID requests as a result of a change to an existing SPID configuration/change of use (i.e. Split / Merge) will be notified to the Licensed Provider who owns the existing SPID impacted by the change. The Licensed Provider shall be identified in the T001.0 request.

Step c: Create Supply Points and issue SPIDs [T002.0, T002.1]

The CMA will issue the SPIDs within 1 Business Day of receipt of the T001.0, using, Data Transaction T002.1 (Notify New SPID (SW)) to Scottish Water and Data Transaction T002.0 (Notify New SPID (LP)) to the relevant Licensed Provider(s).

- i. In the case of a Licensed Provider, this notification will constitute a request to submit a T003.0 (Partial Registration Application) or a T009.2 (Reject New SPID) (see Step d below).
- ii. In the case of Scottish Water, this notification will constitute a request to submit the supporting information for the Supply Point for which they are the Data Owner.

Steps d and e: Process Partial Registrations [T003.0, T009.2]

Where a Licensed Provider(s) considers that they are involved in the New Supply Point, they shall submit a Partial Registration Application using Data Transaction T003.0 within 5 Business Days of receiving the T002.0 (Notify New SPID (LP)).

Where a Licensed Provider considers they are not involved, that Licensed Provider shall submit notification of such to the CMA within 5 Business Days of the CMA issuing the T002.0 (Notify New SPID (LP)) using the Data Transaction T009.2 (Reject New SPID). The CMA will then seek clarification from Scottish Water using Data Transaction T009.1 (Notify Error/Acceptance (SW)), who shall correct the notification of the Licensed Provider for that Supply Point(s) within 1 Business Day by issuing another T001.0 which shall include the Supply Point(s) and the appropriate Licensed Provider. In the event that Scottish Water has no other information than that already notified to the CMA, they shall advise the CMA of this and the CMA shall escalate the matter to the Licensed Provider's Contract Manager.

Steps f-p: Provide Data and Make SPID Tradeable

These processes are common to both New Connections and New Supply Points and are described in Section 4

4. Common Phases of the Connection Process

This section describes the common phases of the connection process for both New Connections and New Supply Points. The only difference between these connection processes are the timescales and the choice of Connection Date in step l below.

4.1 Description of Process Steps

These Steps follow on from Section 2 (New Connections) and Section 3 (New Supply Points). For clarity, there is no break in the labelling of the Steps from the earlier Sections.

The following Steps f through to l, are shown separately for clarity. Step l must be carried out after steps f, g and h, but otherwise the steps may be carried out in parallel rather than sequentially.

At the conclusion of each of Steps j, k and l the SPID will be tested to ensure that enough data has been submitted to complete the Registration, and at that point the SPID will be taken into account during the Settlement Process.

Step f1: Provide Service Element data [T006.2, T006.3, T006.6, T029.1]

Scottish Water shall notify the CMA with the SPID Data in respect of the following Service Elements:

- Troughs and Drinking Bowls;
- Outside Taps;
- Farm or Croft;
- Property Drainage; and
- Roads Drainage

using Data Transactions T006.2 (Submit WS SPID Service Elements) and/or T006.3 (Submit SS SPID Service Elements).

Scottish Water shall notify the CMA of any consent granted by the Commission to Scottish Water to depart from the Wholesale Charges Scheme under section 29E of the 2002 Act for a New Connection using the Data Transaction T029.1 (Submit SPID Special Arrangements). Scottish Water shall at the same time also notify the CMA of any other special arrangements which are applicable from the Connection Date and shall ensure that the effective from date notified with the transactions is prior to the proposed Connection Date.

Scottish Water shall notify the CMA of the Live Rateable Value.

Where an eligible premise has service elements dependent on the Live Rateable Value, then Scottish Water shall ensure that a non-zero value of Live Rateable Value is submitted as follows:

- Where a non-zero Live Rateable Value has been assigned, then the appropriate Live Rateable Value;
- Where a valid Live Rateable Value of £0 has been assigned, then Scottish Water shall submit a Nominal Rateable Value of £0.10;
- Where a value of Live Rateable Value is not available in the short term (for example where a new development has not yet been rated), then Scottish Water shall submit a Default Live Rateable Value chosen at Scottish Water's discretion based upon the type of property, chosen from the following values:
 - o £999.90;
 - o £9,999.90;
 - o £19,999.90;
 - o £99,999.90.
 - o £199,999.90.

- o £299,999.90.
- o £599,999.90.
- o £999,999.90.

Where Scottish Water submits a Default Live Rateable Value for a new Supply Point, Scottish Water shall review the value after six months, at which point it would be expected that an actual value would be available and update the value in accordance with CSD0104. In the event that a value is not available at that time, Scottish Water will continue to review the value periodically, and thereafter to appropriately update it.

If Scottish Water notifies the CMA that property drainage should apply, a value for surface area must also be provided. If a zero value for surface area is submitted, charges will be calculated on a Live RV basis. If a value other than zero is submitted, property drainage charges will instead be calculated based on this surface area.

Following the loading of Scottish Water owned Data, the CMA will carry out the check detailed in Step m “Verify SPID Data Consistent”. If the SPID Data is consistent, then the process will continue at Step n, otherwise the Licensed Provider(s) and/or Scottish Water (as appropriate) will continue to have to load SPID Data.

Step f2: CMA updates Central Systems and notifies Licensed Provider [T006.4, T006.5, T006.7, T029.0]

The CMA will load the data to the Central Systems and provide the data to the Licensed Provider(s) using Data Transactions T006.4 (Notify WS SPID Elements), T006.5 (Notify SS SPID Service Elements), T006.7 (Notify Live Rateable Value) and/or T029.0 (Notify SPID Special Arrangements).

Step g1: Provide meter details & Initial Read [T004.0, T005.0, T033.0]

Within 5 Business Days, for activities undertaken by Scottish Water and 8 Business Days for activities undertaken by an Accredited Entity, of the meter installation, Scottish Water will notify the CMA of the meter(s) details for each meter installed at the Supply Point, using Data Transaction T004.0 (Request New Meter). This shall include identifying the Meter Treatment Type. In the case of a meter with a Meter Treatment Type of Private Water, Private Effluent, or Tankered Effluent, the associated Chargeable Meter Size must be zero and in the case of a meter with a Meter Treatment Type of Private Effluent, or Tankered Effluent, the Sewerage Chargeable Meter Size and the Non-Return to Sewer Allowance must be zero. For all Meter Treatment Types, the Meter Read Frequency must either be monthly or bi-annually.

Scottish Water will also include within this transaction, the meter location and data logger flags to indicate the presence or absence of data loggers at a meter and the Physical Meter Size. The meter location should be notified in the form of OSGB X, Y co-ordinates in an all numeric format and should also include a Meter Location Code. The meter location must be provided for meters with a Meter Treatment Type of SW Water, Private Water or Private Effluent. The provision of the meter location is optional, otherwise. Data loggers can be either Scottish Water data loggers or non-Scottish Water data loggers. Both data logger types can be present at a meter at the same time. Scottish Water will also identify whether the meter installation was undertaken by an Accredited Entity. The Physical Meter Size must be provided for meters with a Meter Treatment Type of SW Water, or Private Water. Otherwise, the provision of the Physical Meter Size is optional.

Within 1 Business Day of receiving the T004.0 (Request New Meter), the CMA will validate the transaction, such validation will include a check that the GISX and GISY co-ordinates provided are not clearly out with the boundaries of Scotland before processing the transaction in the Central Systems. In the event that this is not the case, or that another aspect of validation fails, the CMA will issue a T009.1 (Notify Error/Acceptance (SW)) to Scottish Water.

Within 5 Business Days, for activities undertaken by Scottish Water and 8 Business Days for activities undertaken by an Accredited Entity, of the meter installation Scottish Water will provide the Initial Read(s) for the meter(s) to the CMA using Data Transaction T005.0 (Submit Meter Read (SW)). In the case of a Sewerage Services SPID with a Related Water Supply Meter, the Initial Read submitted in respect of the associated Water Services Supply Point will be applied to the Sewerage Services SPID.

In the case of Sewerage Services, subject to any Trade Effluent Services and any notification from Scottish Water as to any metering arrangements at the Supply Point for Sewerage Service, the CMA will associate the meter(s) details of the Related Water Supply Meter(s) at the corresponding Water Services Supply Point(s).

Within 5 Business Days, for activities undertaken by Scottish Water and 8 Business Days for activities undertaken by an Accredited Entity, of the meter installation, Scottish Water will also provide details of whether a SPID is a Metered Building Water SPID using Data Transaction T033.0 (Submit Metered Building Water). In the case of a Sewerage Services SPID with a related Water Supply Meter, the T033.0 submitted in respect of the associated Water Services Supply Point will be applied to the Sewerage Services Supply Point.

Once a Supply Point has a status of Metered Building Water it cannot revert to a status of Unmeasurable.

Step g2: CMA loads SPID data and notifies Licensed Provider [T004.1 T005.2, T033.1]

The CMA will load the data to the Central Systems and notify it to the Licensed Provider(s) using Data Transactions T004.1 (Notify Meter Details), T005.2 (Notify Meter Read (LP)) and T033.1 (Notify Metered Building Water).

The T004.1 and T005.2 notifications also constitute confirmation that the notified Service Elements and Meter Read information will be used in the calculation of Wholesale Charges.

Step g3: Licensed Provider Submits YVe [T004.2]

Following the notification of a meter, the Water Services Licensed Provider may submit the YVe for the New Supply Point using the data Transaction T004.2 (Submit Meter YVE Details). In the absence of such notification, the CMA will use an appropriate Industry Level Estimate.

Note: For the avoidance of doubt, this Step is not shown on the Process Diagram.

Step h: Provide Trade Effluent Data and Meter Network Data

In the event that Trade Effluent Services are applicable Scottish Water shall provide the CMA with the Trade Effluent Data in accordance with CSD0206 (Trade Effluent Processes). The CMA will load the Data and notify the Licensed Provider. In the event that a meter installed at the Supply Point is in a Meter Network, Scottish Water shall provide the CMA with the Meter Network data in accordance with CSD0104.

Step j1: Provide Licensed Provider owned SPID data & CMA loads Data [T006.0, T006.1]

During the period of the Partial Registration², the Licensed Provider will provide the CMA with the SPID Data for which they are the Data Owner using the Data Transactions T006.0 (Submit WS SPID Data) or T006.1 (Submit SS SPID Data). Licensed Provider updates to Water Supply Points will be copied across to any associated Sewerage Services Supply Points. Licensed Providers may only provide updates to Sewerage Services Supply Points which either do not have an associated Water Services Supply Point, or have an associated Water Services Supply Point which is disconnected or deregistered.

Following the loading of Licensed Provider owned Data, the CMA will carry out the check detailed in Step m “Verify SPID Data Consistent”. If the SPID Data is consistent, then the process will continue at Step n, otherwise the Licensed Provider(s) and/or Scottish Water (as appropriate) will continue to have to load SPID Data.

² Upon completion of the Registration, updates to SPID Data are managed under Maintain SPID Data CSD0104.

Step j2: Notify Scottish Water [T006.8]

Following the successful submission of the LP owned SPID Data, the CMA will notify Scottish Water of that data using Data Transaction T006.8 (Notify WS/SS SPID Data).

Step k: Provide Customer Name [T032.0]

The Water Services Supply Point Licensed Provider will also submit Customer name and Customer name type (“Customer” or “Developer³”) data for the new Supply Point using data transaction T032.0 (Submit Customer Name). The Customer name must start with a letter or a number and must be a minimum of one character and cannot contain any control characters e.g. carriage returns, line feeds etc.

The Sewerage Services Supply Point Licensed Provider, where there is no associated Water Services Supply Point, will also submit Customer name and Customer name type (“Customer” or “Developer³”) data for the new Supply Point using data transaction T032.0 (Submit Customer Name). The Customer name must start with a letter or a number and must be a minimum of one character and cannot contain any control characters e.g. carriage returns, line feeds etc.

The Customer name that is provided should in all cases be the party contracting with the LP at the Supply Point i.e. the Customer or developer at the Supply Point. Where the Supply Point has a Related Water Supply Point, the Customer name notified at the Water Services Supply Point will also be used for the associated Sewerage Services Supply Point. If the Water Services Supply Point has an associated Sewerage Services Supply Point and which has a different LP, a T032.1 (Notify Customer Name) transaction containing the updated Customer name, will be sent to the LP for the associated Sewerage Services Supply Point.

Where the Sewerage Services Supply Point has an associated Water Supply Point, a Customer name notified in error at the Sewerage Services Supply Point will receive a T009.0 (Notify Error/Acceptance (LP)) transaction displaying a message that indicates the Supply Point is a Sewerage Services Supply Point that has a Water Services Supply Point. Where a new Water Services Supply Point is associated with an existing Sewerage Services Supply Point the Customer name from the Sewerage Services Supply Point will be applied at the point of association.

If the transaction is successful, a T009.0 OK transaction is returned and a T032.2 (Notify Customer Name) issued to Scottish Water. In the event that the data is not consistent, the CMA will issue a T009.1 (Notify Error/Acceptance (SW)) to the LP. If the Customer name is

³ Developer should be submitted where the contracting party is a developer rather than an actual customer.

not in a valid format a T009.0 (Notify Error/Acceptance (LP)) transaction with an appropriate error code.

Following the loading of a Customer name, the CMA will carry out the check detailed in Decision m “Verify SPID Data Consistent”. If the SPID Data is consistent, then the process will continue at Step n, otherwise the Licensed Provider(s) and/or Scottish Water (as appropriate) will continue to have to load SPID Data.

Step I: Submit Connection Data

Scottish Water is always responsible for providing the Connection Date at a Supply Point. Where a Sewerage Services Supply Point has an associated Water Point that has not yet been made Tradeable, the Connection Date notified by Scottish Water at the associated Water Services Supply Point will also be used for the Sewerage Services Supply Point.

In the event that only Sewerage Services are provided at the Supply Point or the associated Water Services Supply Point has already been made Tradeable, then for the Sewerage Services Supply Point Scottish Water must confirm the Connection Date for those Services to the CMA.

New Connections:

Scottish Water will notify the CMA of the Connection Date of a Water Services Supply Point within 5 Business Days, for activities undertaken by Scottish Water and 8 Business Days for activities undertaken by an Accredited Entity, using Data Transaction T007.0 (Submit Connection Complete (WS)). As above, this Connection Date will also be used for any associated Sewerage Service Supply Point which is not already Tradeable. The CMA will confirm that the Water Services Supply Point any associated Sewerage Service Supply Point which is not already Tradeable each has at least one Service Element on the Connection Date.

If the Connection is successful, the CMA will notify the Water Services Licensed Provider(s) of the Connection Date using Data Transaction T007.2 (Notify Connection Complete). In the case of a Related Water Supply Meter, the Sewerage Services Licensed Provider will be notified by the CMA of the Connection Date using the Data Transaction T007.2 (Notify Connection Complete).

When a meter has been notified to the CMA and Scottish Water has submitted an I Read, the T007.0 (Submit Connection Complete (WS)) will set the meter effective from date and the I Read date to equal the latter of the I Read date or the SPID Connection Date.

In the event that only Sewerage Services are provided at the Supply Point or the associated Water Service Supply Point has already been made Tradeable, then Scottish Water will notify the CMA of the Connection Date within 5 Business Days after that connection is made using Data Transaction T007.1 (Submit Connection Complete (SS)).

Following the loading of a Connection Date, the CMA will carry out the check detailed in Decision m “Verify SPID Data Consistent”. If the SPID Data is consistent, then the process will continue at Step n, otherwise the Licensed Provider(s) and/or Scottish Water (as appropriate) will continue to have to load SPID Data.

New Supply Points:

Scottish Water will, confirm the Connection Date of a Water Services Supply Point to the CMA using the Data Transaction T007.0 (Submit Connection Complete (WS)) within 15 Business Days of receiving the T002.1 (Notify New SPID (SW)). As above, this Connection Date will also be used for any associated Sewerage Service Supply Point which is not already Tradeable. The Connection Date for the New Supply Point(s) shall be 5 Business Days after the Data Transaction T002.1 (Notify New SPID (SW)).

When a meter has been notified to the CMA and Scottish Water has submitted an I Read, the T007.0 (Submit Connection Complete (WS)) will set the meter effective from date and the I Read date to equal the latter of the I Read date or the SPID Connection Date.

In the event that only Sewerage Services are provided at the New Supply Point or the associated Water Service Supply Point has already been made Tradeable, then the Sewerage Services Licensed Provider will notify the CMA of the Connection Date using Data Transaction T007.1 (Submit Connection Complete (SS)) within 15 Business Days of receiving the T002.1 (Notify New SPID (SW)).

Following the loading of a Connection Date, the CMA will carry out the check detailed in Decision m “Verify SPID Data Consistent”. If the SPID Data is consistent, then the process will continue at Step n, otherwise the Licensed Provider(s) and/or Scottish Water (as appropriate) will continue to have to load SPID Data.

As part of the T007.0 (Submit Connection Complete (WS)), Scottish Water will also identify whether the connection has been made by an Accredited Entity.

Decision m: Verify SPID Data consistent

For a:

- Water Services Supply Point with any associated Sewerage Services Supply Point which is not already Tradeable:

and following the successful submission of any of

- T003.0 (Partial Registration Application)
- T006.0 (Submit WS SPID Data)
- T006.6 (Submit Live Rateable Value)
- T007.0 (Submit Connection Complete (WS))
- T032.0 (Submit Customer Name)

or for either:

- a Sewerage Services Supply Point which does not have an associated Water Services Supply Point; or
- a Sewerage Services Supply Point which has an associated Water Services Supply Point that is already Tradeable,

and following the successful submission of any of:

- T003.0 (Partial Registration Application)
- T006.1 (Submit SS SPID Data)
- T006.6 (Submit Live Rateable Value)
- T007.1 (Submit Connection Complete (SS))
- T032.0 (Submit Customer Name)

the CMA will run a data check on that SPID to verify that the SPID Data is consistent. Further details of the data check are set out in Appendix 1 of this CSD. Broadly, the data check will confirm that the SPID has at least one Service Element on the Connection Date, and if any such Service Element is dependent on the Live Rateable Value, that a non-zero Live Rateable Value has been successfully submitted. In the case of a Water Services Supply Point with an associated Sewerage Services Supply Point, the associated Sewerage Services Supply Point must also pass the consistency test. In the event that this data check is successful, the Registration is complete and the SPID (and where applicable any associated Sewerage Services Supply Point) will be deemed to be Tradeable and can be accounted for in the Settlement Process.

Step n: Make SPID Tradeable

When the Registration of a SPID is complete, the CMA will notify both Scottish Water and the Licensed Provider that the SPID is Tradeable using transactions T035.0 (Notify Tradeability) and T035.1 (Notify Tradability) respectively. For the avoidance of doubt, when both a SPID and an associated Sewerage Services SPID become Tradeable, then the CMA will send separate transactions to both Scottish Water and the Licensed Provider in respect of each SPID.

The absence of such notifications will mean that the data check was unsuccessful, and that the SPID(s) are not yet Tradeable.

Some of these events that cause the data check to be unsuccessful may only be capable of remedy through the use of the process set out in CSD0105 (Error Rectification & Retrospective Amendments), which may incur an Additional Service Charge. Following any such Retrospective Amendment, one of the Trading Parties will need to re-submit one of the above flows which trigger the data consistency check to make the SPID(s) Tradeable.

Step p: Monitor and Supply required data

In accordance with CSD0302, the CMA shall provide the Trading Parties (TP) with the New and Partial SPIDs report (NAPS) which contains information about SPIDs which are New, Partial or Rejected. It is the responsibility of each Trading Party to monitor this report, and to submit appropriate data so that the SPID can be made Tradeable. If the SPID has been registered in error, then it is the responsibility of Scottish Water to submit an appropriate T015.0 (Submit SPID Status) flow to deregister the SPID.

The CMA will monitor all Partial Registrations and, in the case of an ongoing failure to provide requested information, will report such failure to the CMA Board.

In the event that a Retrospective Amendment is the only means of resolution, the matter should be progressed in accordance with CSD0105 (Error Rectification & Retrospective Amendments).

4.2 Process Diagrams

New Connection - Page 1A

Updated October 2019

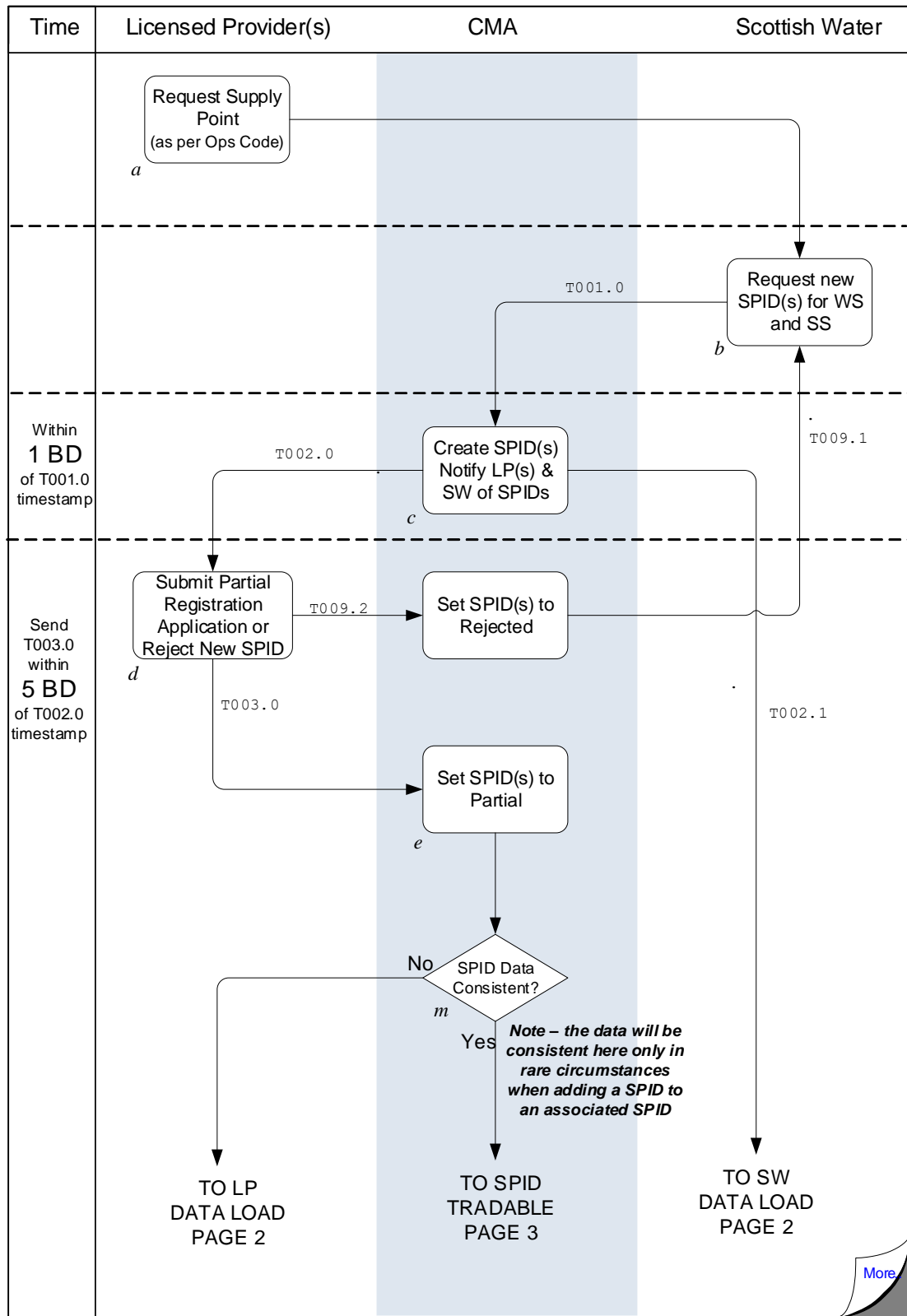

New Supply Point
 Where a Licensed Provider becomes aware
 of a Change of Use or a Gap Site – Page 1B

Updated October 2019

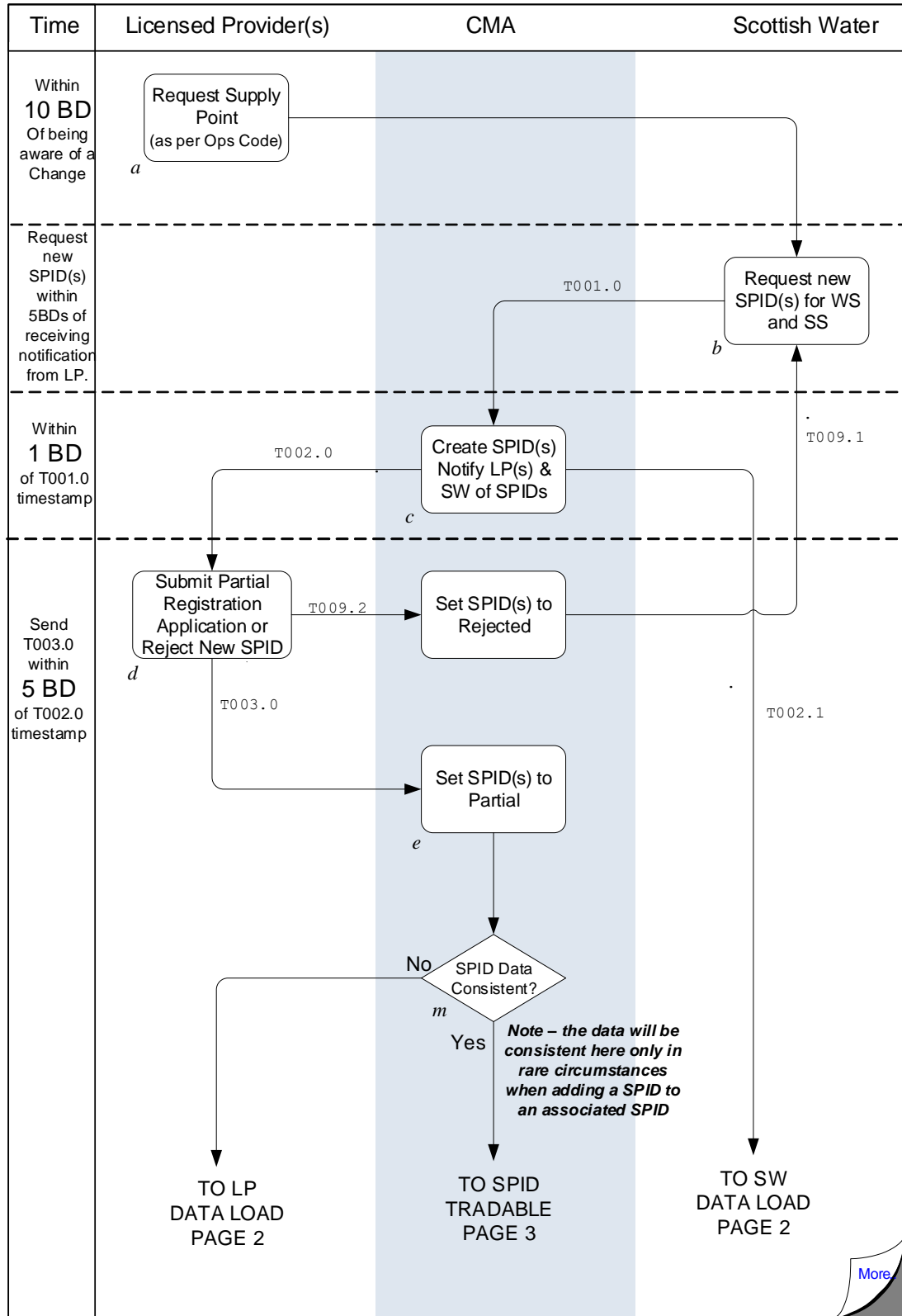

New Supply Point
 Where Scottish Water becomes aware of a
 Change of Use or a Gap Site – Page 1C

Updated February 2018

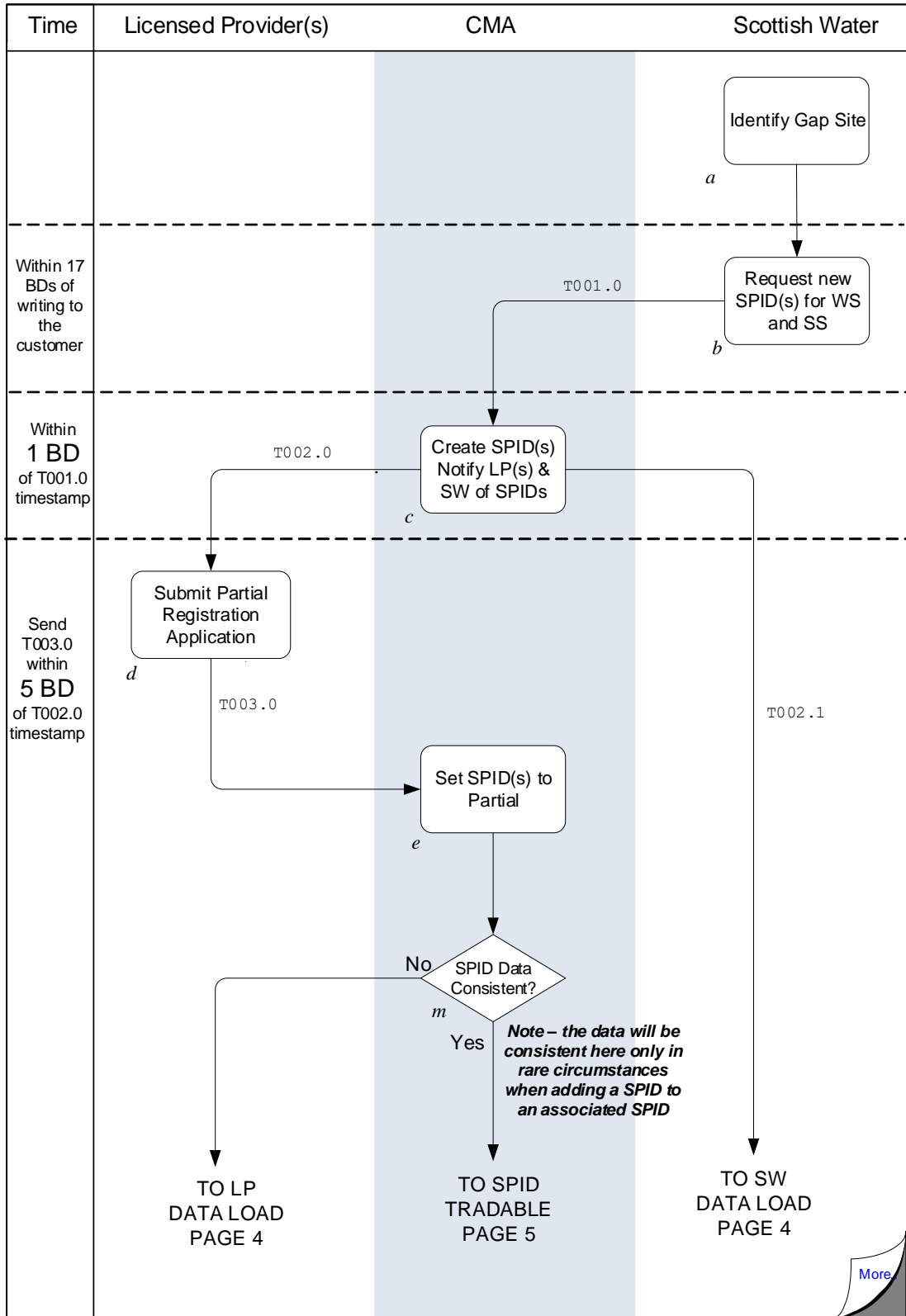

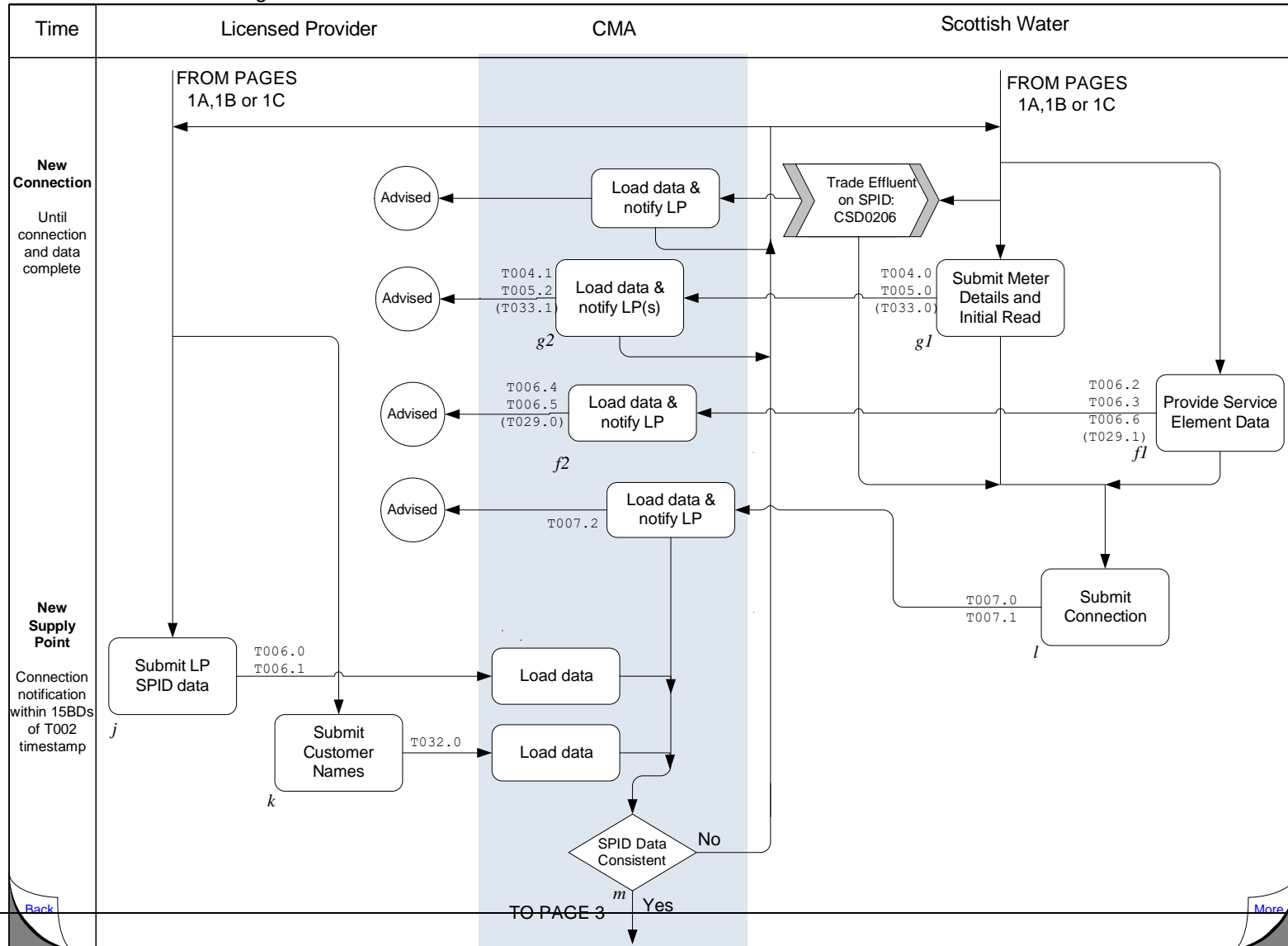

[Back](#)

[More](#)

TO PAGE 3

Common Process – Page 3/3

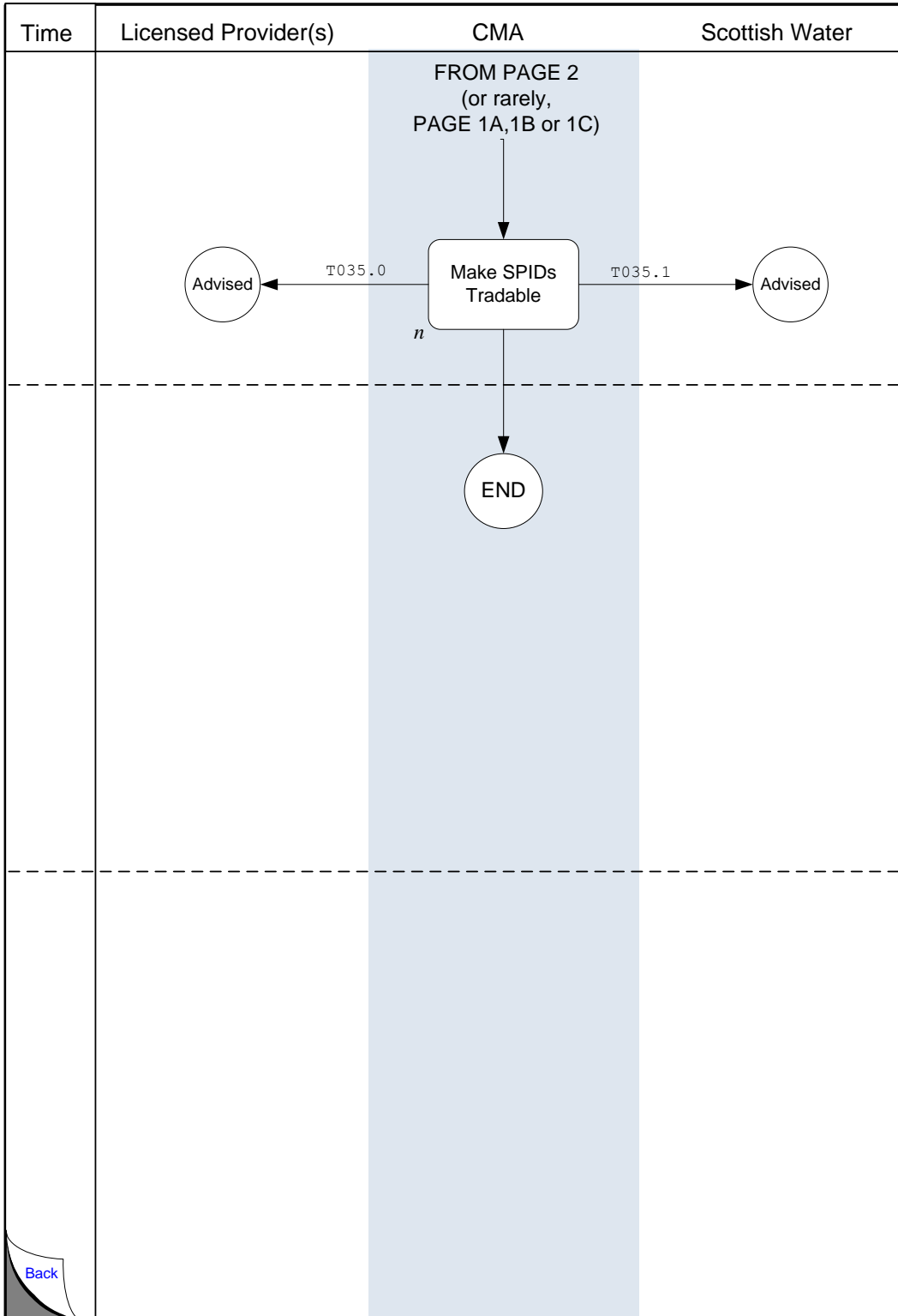

4.3 Interface and Timetable Requirements

step ID	Action/ Decision	Process Step	From	To	Time parameter	Comments	Mkt code Ref	Clause	(indicative) Data Transaction ID
New Connections									
a	S	Request Supply Point	LP	SW					
b	S	Request new Supply Point(s) for WS & SS	SW	CMA	greater than one month before Connection Date		5.4.1	i	T001.0
c	S	Create SPID(s), set SPID Status "N", Notify LP(s) & SW of SPID(s)	CMA	LP	1BD		5.4.1	ii	T002.0
c	S	Create SPID(s), set SPID Status "N", Notify LP(s) & SW of SPID(s)	CMA	SW	1BD		5.4.1	ii	T002.1
d	S	Submit Partial Registration Application	LP	CMA	within 5BD of T002 timestamp		5.4.1.	iii	T003.0
e	S	Load SPID Data,	CMA		1BD				
New Supply Points – Licensed Provider Initiated									
a	S	Identify Entry Change of Use or Gap Site	LP	SW			5.4.9	I	
b	S	Request new Supply Point(s) for WS & SS	SW	CMA	within 5BD		5.4.9	ii	T001.0
c	S	Create SPID(s), Notify LP(s) & SW of SPID(s)	CMA	LP	1BD		5.4.1		T002.0
c	S	Create SPID(s), Notify LP(s) & SW of SPID(s)	CMA	SW	1BD		5.4.1		T002.1
d	S	Submit Partial Registration Application	LP	CMA	within 5 BD of T002 timestamp		5.4.1.	iii	T003.0

step ID	Action/ Decision	Process Step	From	To	Time parameter	Comments	Mkt code Ref	Clause	(indicative) Data Transaction ID
e	S	Load SPID Data,	CMA		1BD				
New Supply Points – Scottish Water Initiated									
a	S	Identify Change of Use or Gap Site	LP	SW					
b	S	Request new Supply Point(s) for WS & SS	SW	CMA	within 17BDs of the date of its letter to non-household customer		5.4.9		T001.0
c	S	Create SPID(s), Allocate LP, Notify LP(s) & SW of SPID(s)	CMA	LP	1BD		5.4.1		T002.0
c	S	Create SPID(s), Allocate LP, Notify LP(s) & SW of SPID(s)	CMA	SW	1BD		5.4.1		T002.1
c1		SW sends copy of gap site letter to LP	SW	LP	Upon Request		5.4.11	iv	
d	S	Submit Partial Registration Application	LP	CMA	within 5 BD of T002 timestamp		5.4.1.	iii	T003.0
e	S	Load SPID Data,	CMA		1BD				
Common Phases of the Process									
f1	S	Provide WS Service Element data and SS Service Element data (including Trade Effluent)	SW	CMA	New Connections: before connection	Any TE transactions received from CSD0206 will also be processed. If 29E arrangements in place, notify CMA.	5.4.2	i	T006.2 T006.3 T006.6 T029.1

step ID	Action/ Decision	Process Step	From	To	Time parameter	Comments	Mkt code Ref	Clause	(indicative) Data Transaction ID
f2	S	Load data & notify to LP	CMA	LP	1BD	Any TE transactions received from CSD0206 will also be notified	5.4.2.	ii	T006.4 T006.5 T029.0
g1	S	Provide meter details & Initial Read Including meter location and Metered Building Water status.	SW	CMA	New Connections: before connection	Metered Building Water status – default setting is False	5.4.4	i, ii	T004.0, T005.0 (T033.0)
g2	S	Load data & notify LP of meter (or RWSM) details and read and Metered Building Water status	CMA	LP	1BD		5.4.4.	iii	T004.1, T005.2 (T033.1)
g3	S	(Optional) provision of YVe	LP	CMA					T004.2
J1	S	Provide SPID data.	LP	CMA	: Until Tradeable		5.4.3		T006.0 T006.1 T032.0
	S	Load data	CMA	internal	1BD				
J2	S	Notify SW	CMA	SW	Following j1		5.4.3		T006.8
k	S	Provide Customer name.	LP	CMA	: Until Tradeable		5.4.3		T0032.0
	S	Load data	CMA	internal	1BD				
l	S	Confirm WS connection completed (If associated SS, use Connection Date for associated SS SPID)	SW	CMA	New Connections: within 5/8 BD of the Connection Date New Supply Points: Within 15BDs of T002		5.4.5		T007.0

step ID	Action/ Decision	Process Step	From	To	Time parameter	Comments	Mkt code Ref	Clause	(indicative) Data Transaction ID
l	S	Confirm SS connection completed if required (i.e. no associated WS)	SW	CMA	New Connections: within 5/8 BD of the Connection Date New Supply Points: Within 15BDs of T002		5.4.5		T007.1
	S	Load data and notify LPs	CMA	LPs	1BD		5.4.5		T007.2
m	D	SPID Data consistent?	CMA	LP	after Steps f,j,k,l		5.4.6		T009.0
n	S	Make SPID Tradeable; notify SW	CMA	SW	After decision m returns yes		5.4.6		T035.0
n	S	Make SPID Tradeable; notify SW	CMA	LP	After decision m returns yes		5.4.6		T035.1
p	S	Create New & Partial SPIDs report	CMA	LP/SW	monthly	Report sent			none
p	S	Monitor NAPS report	LP/SW	CMA	monthly	Take action as necessary			none

Appendix 1: Registration Data Checks at a New Connection/New Supply Point

A number of data checks occur in the Central Systems during the New Connection and New Supply Point processes. These are covered in the body of this document, and summarised here. The intention of this appendix is to provide a list of checks, in order to facilitate the data supplier providing the data in full and in the correct timeframe.

Section 2 Process data checks



Step Name	Data supplier	Transaction	For Data items refer to CSD0301 Data Transaction Catalogue	CMA data checks on receipt of transaction* For a list of the Data Items in each Transaction, refer to CSD0301 (the Data Transaction Catalogue) :
Request new SPID(s) for WS & SS	SW	T001.0 Request New SPID		LP not licensed for category of Services Required Data Items are present and valid
Submit Partial Registration Application	LP	T003.0 Partial Registration Application		LP nominated in T001.0 Note - should be received within 5BD) of T001.0 timestamp; if not, in the case of New Connections, the CMA escalates the matter.
Provide Service Element data	SW	T006.2 T006.3 & T006.6 Submit WS or SS SPID Service Elements		Valid data items and values as set out in CSD0301 (the Data Transaction Catalogue)

Step Name	Data supplier	Transaction	For Data items refer to CSD0301 Data Transaction Catalogue	CMA data checks on receipt of transaction* For a list of the Data Items in each Transaction, refer to CSD0301 (the Data Transaction Catalogue) :
<p>If WS, or SS with SM: Provide meter details & initial read</p>	SW	T004.0 Request New Meter		<p>Note – a meter will not be in charge unless a T005.0 has also been successfully submitted For Meter Treatments of; Private Water, Private Effluent, or Tankered Effluent; Chargeable Meter Size must be zero. For Meter Treatments of; Private Effluent, or Tankered Effluent; Sewerage Chargeable Meter Size and Non-Return to Sewer Allowance must be zero. Meter Read Frequency must be “M” or “B”.</p>
<p>If WS, or SS with SM: Provide meter details & initial read</p>	SW	T005.0 Submit Meter Read (SW) T016.0 T016.1 Update/Notify SPID Unmeasurable Status		<p>Meter Read type must = Initial Meter Read date cannot be in the future, or before SPID creation date (see Meter Read Submission Validation CSD0203 for further details) Note: T005.0 is not required for New Supply Points If the SPID does not have a meter and has an unmeasurable water supply.</p>
<p>Provide SPID data</p>	LP	T006.0 T006.1 Submit WS or SS SPID Data T032.0 Submit Customer Name		<p>Valid data items and values as set out in CSD0301 (the Data Transaction Catalogue).</p>

Step Name	Data supplier	Transaction	For Data items refer to CSD0301 Data Transaction Catalogue	CMA data checks on receipt of transaction* For a list of the Data Items in each Transaction, refer to CSD0301 (the Data Transaction Catalogue) :
<div style="border: 1px solid black; border-radius: 10px; padding: 5px; width: fit-content;"> Confirm SS connection completed if SM or if no WS </div>	SW	T007.1 Submit Connection Complete (SS)		<p>Submitted by SW. The CMA will check that the SS has at least one Service Element active on the Connection Date. Flow is valid only for an SS SPID without an associated WS SPID, or where there is a WS SPID which is Tradeable, TDISC, TTRAN, PPDISC, PDISC or DEREK.</p> <p>When Trade Effluent Services have been notified, then the start date of the Trade Effluent Services will be set to the Connection Date notified in the flow.</p>
<div style="border: 1px solid black; border-radius: 10px; padding: 5px; width: fit-content;"> Confirm WS connection completed - date defaults to SS </div>	SW	T007.0 Submit Connection Complete (WS)		<p>Submitted by SW. The CMA will check that the WS has at least one Service Element active on the Connection Date, and that if there is an associated SS SPID which is New, Partial or Rejected that the SS SPID has at least one Service Element active on the Connection Date.</p> <p>When a meter has been notified to the CMA and Scottish Water has submitted an I Read, the T007.0 will set the meter effective from date and the I Read date to equal the latter of the I Read date or the SPID Connection Date.</p> <p>Where Trade Effluent Services have been notified to an associated SS SPID (which is New, Partial or Rejected) Services, then the start date of the Trade Effluent Services will be set to the Connection Date notified in the flow.</p>

Step Name	Data supplier	Transaction	For Data items refer to CSD0301 Data Transaction Catalogue	CMA data checks on receipt of transaction* For a list of the Data Items in each Transaction, refer to CSD0301 (the Data Transaction Catalogue) :
	n/a	n/a		<ul style="list-style-type: none"> • Check that a Partial Registration has been received for the SPID; • Check the SPID has at least one Service Element acting on the Connection Date, and if any such Service Element is dependent on the Rateable Value and/or Live Rateable Value, that a non-zero Rateable Value and/or Live Rateable Value has been successfully submitted; • Check that a Customer name has been submitted • Check that a Connection Date has been submitted <p>In the case that a WS has an associated SS which is New, Partial or Rejected both the WS and the associated SS must pass the above tests. If the tests are passed the SPID(s) become Tradeable</p>

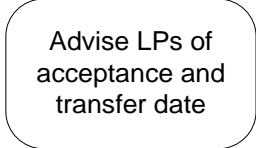
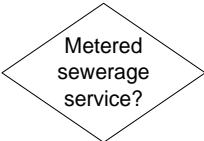
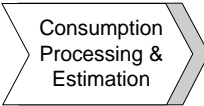
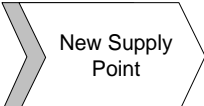
Appendix 2 : Process Flowchart Symbols

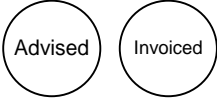
Symbol	Name	Details
	Step	An action step. It appears in the "swimlane" of the party responsible for performing the action.
	Decision	A decisive question rather than an action. Followed by Yes or No, or occasionally WS (Water Service) or SS (Sewerage Service) the process splits depending on the answer to the question in the decision diamond.
	To another process	A flow in, or input to, another documented process
	From another process	A flow in, or output from another documented process.
	To and from another process	Used where a process is embedded within another. At this point, go to the embedded process chart before returning to the one in which it is embedded.
	End	Used after a decision diamond, generally to mean "do nothing" as it is the end of the process.
	Advised/Invoiced	Used after a process step to show "passive" action on the part of a data flow receiver e.g. to represent "Advised" or "Invoiced"
<i>g</i>	Step/Decision reference	An alphabetic reference beside each step and decision. This reference appears on the table in each section to facilitate reading the table against the process flowcharts.
T015.0	Transaction reference	Reference to the data transaction occurring as an output from the step it appears next to.